

SUMP PUMP

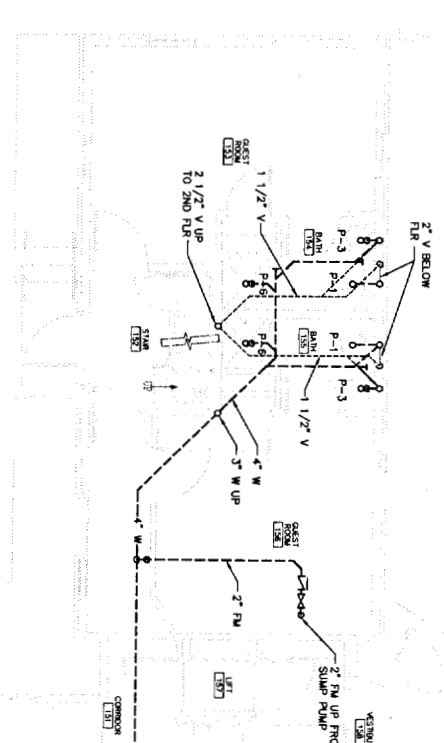

PLAN

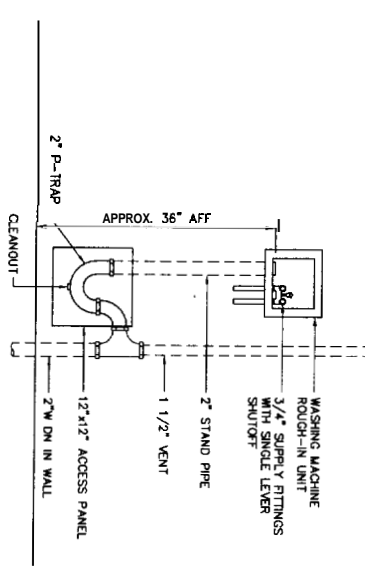
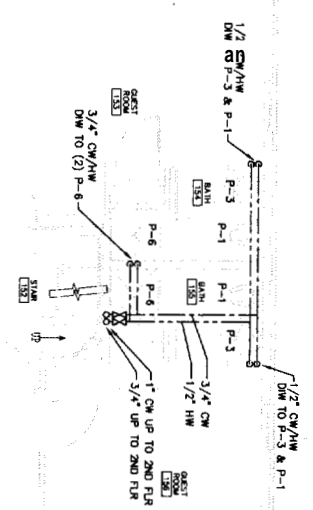

EX. ENCL. ON [157]

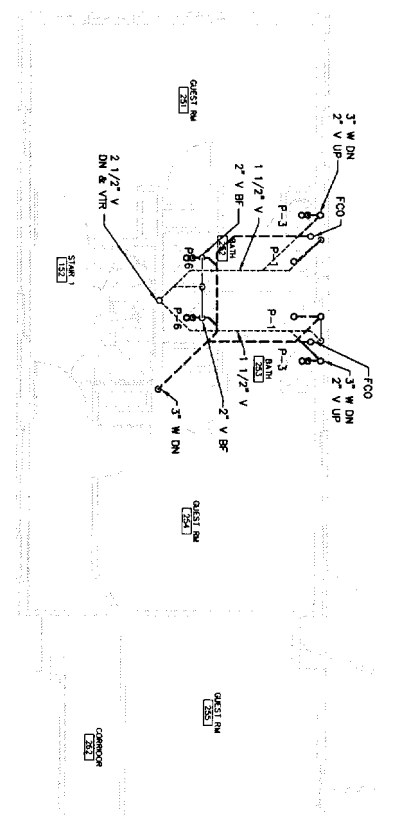
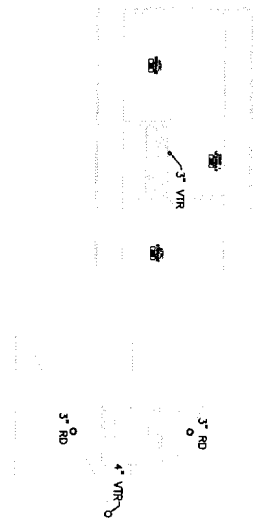

COOR

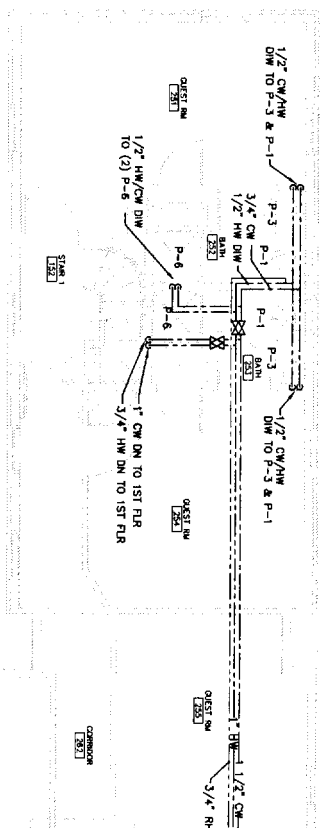

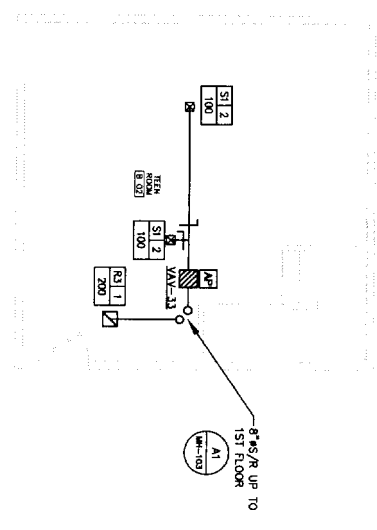

OOM

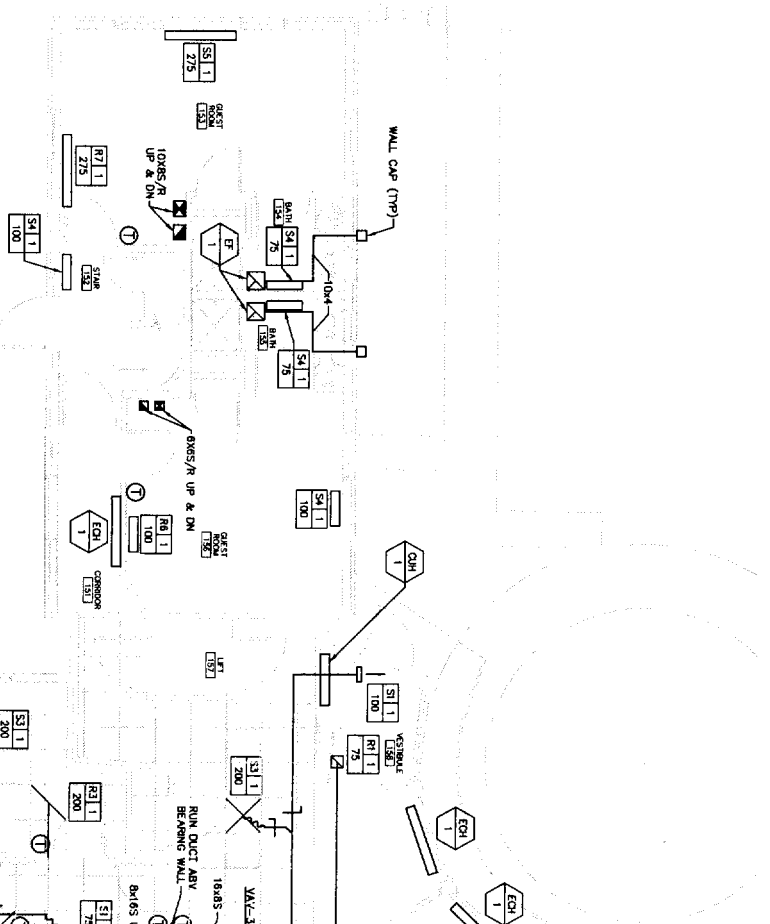
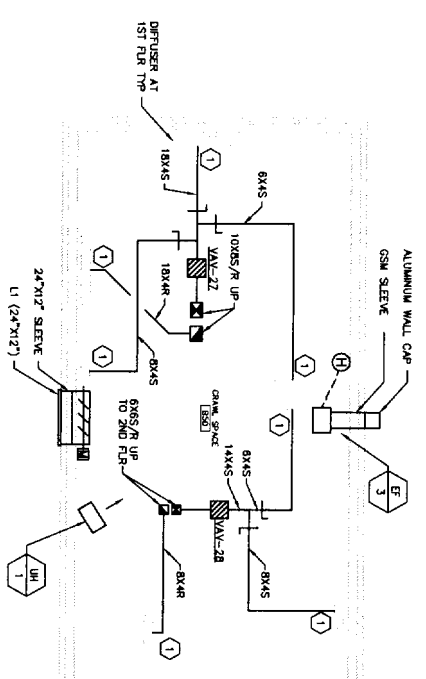

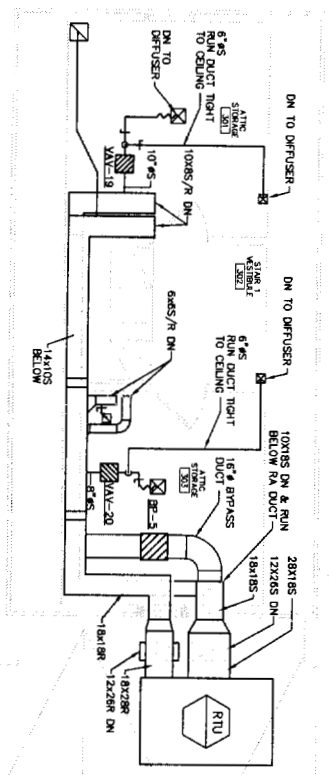

KEYED NOTES:

- ① 10X8 DN DRIP DN TO GRAMSPACE.
- ② 8X8 DN DRIP DN TO 1ST FLOOR.

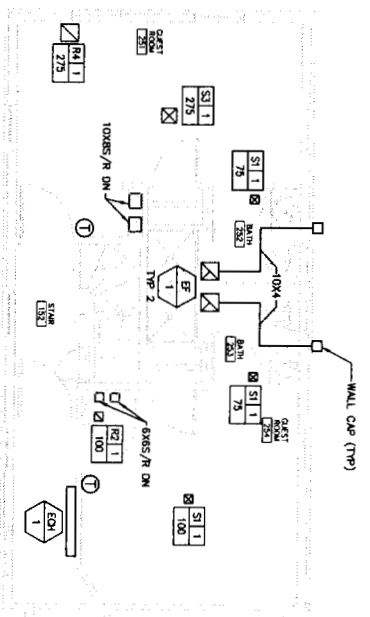

NOTE: RUN DUCT U BETWEEN FRAMING MEMBERS AS REQUIRED.

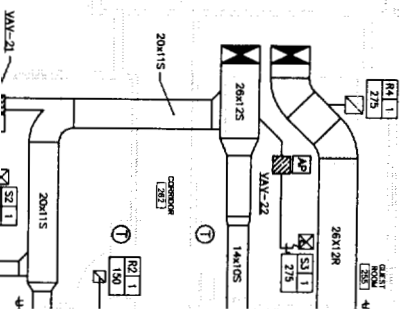

C

D

E

F

G

H

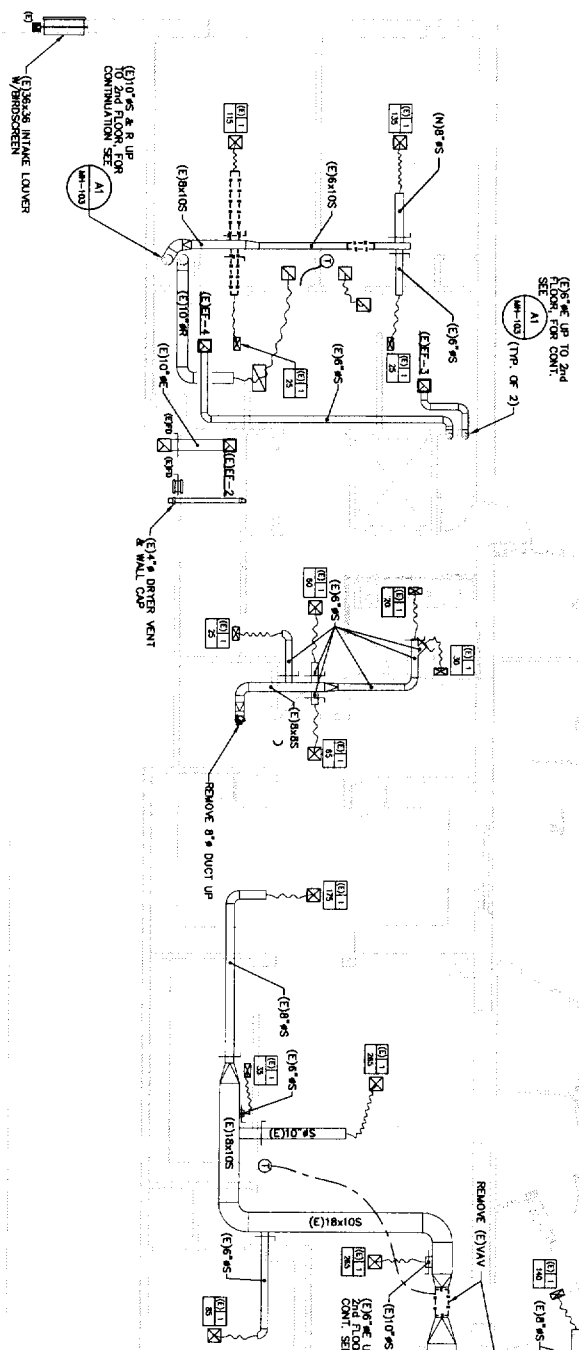

NOTES:
CONNECT NEW YAV BOXES TO EXISTING BRANCH CIRCUITS.

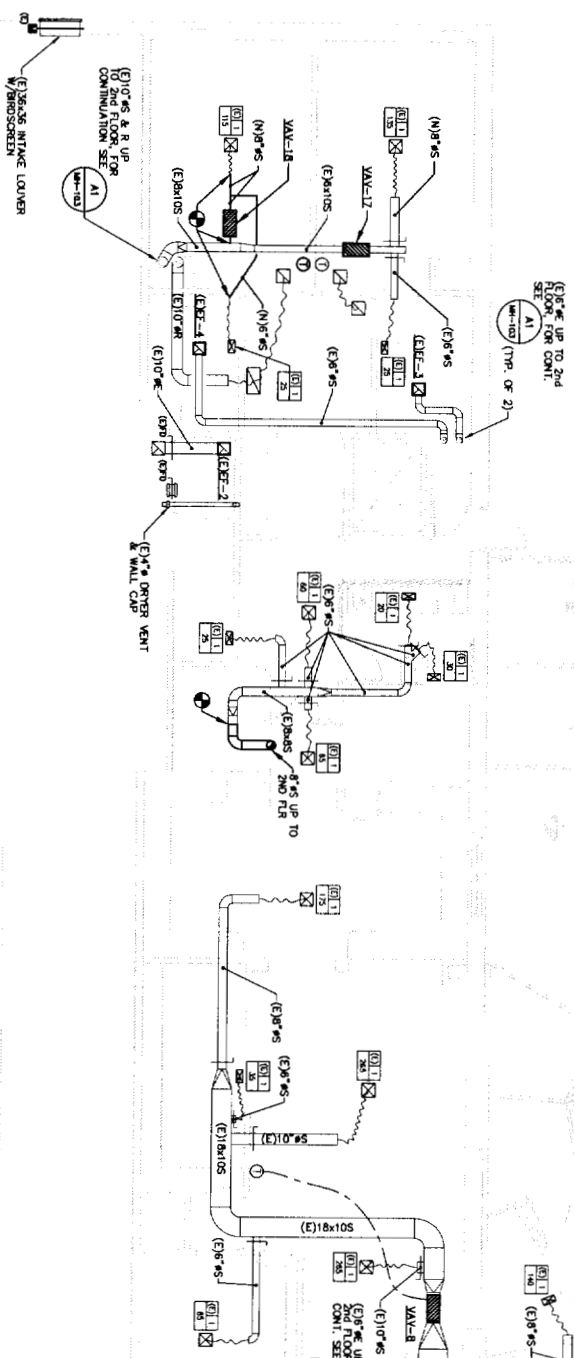

H
G
F
E
D
C

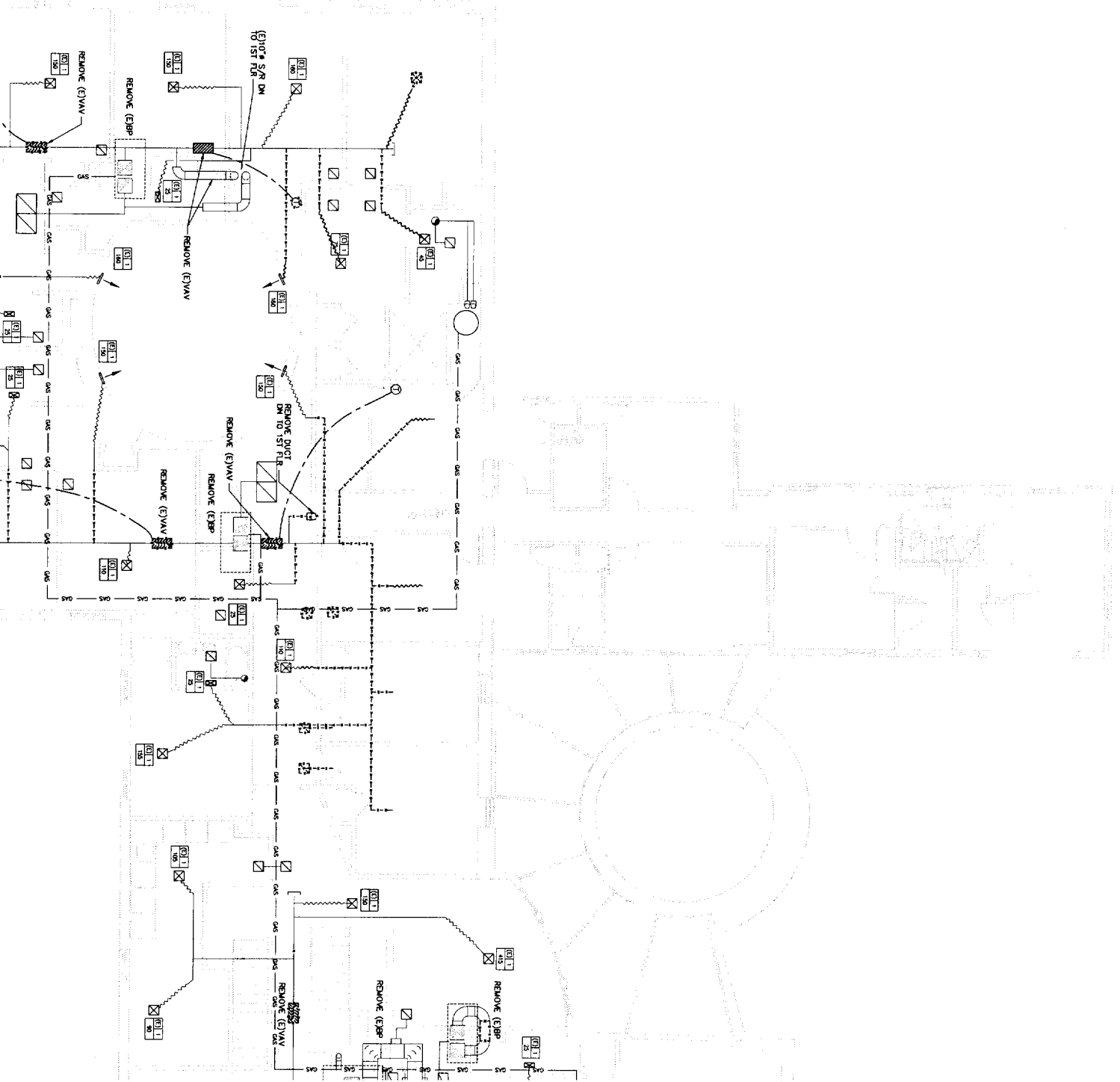

NOTES:
CONNECT NEW VAV BOXES TO EXISTING BRANCH CIRCUITS.

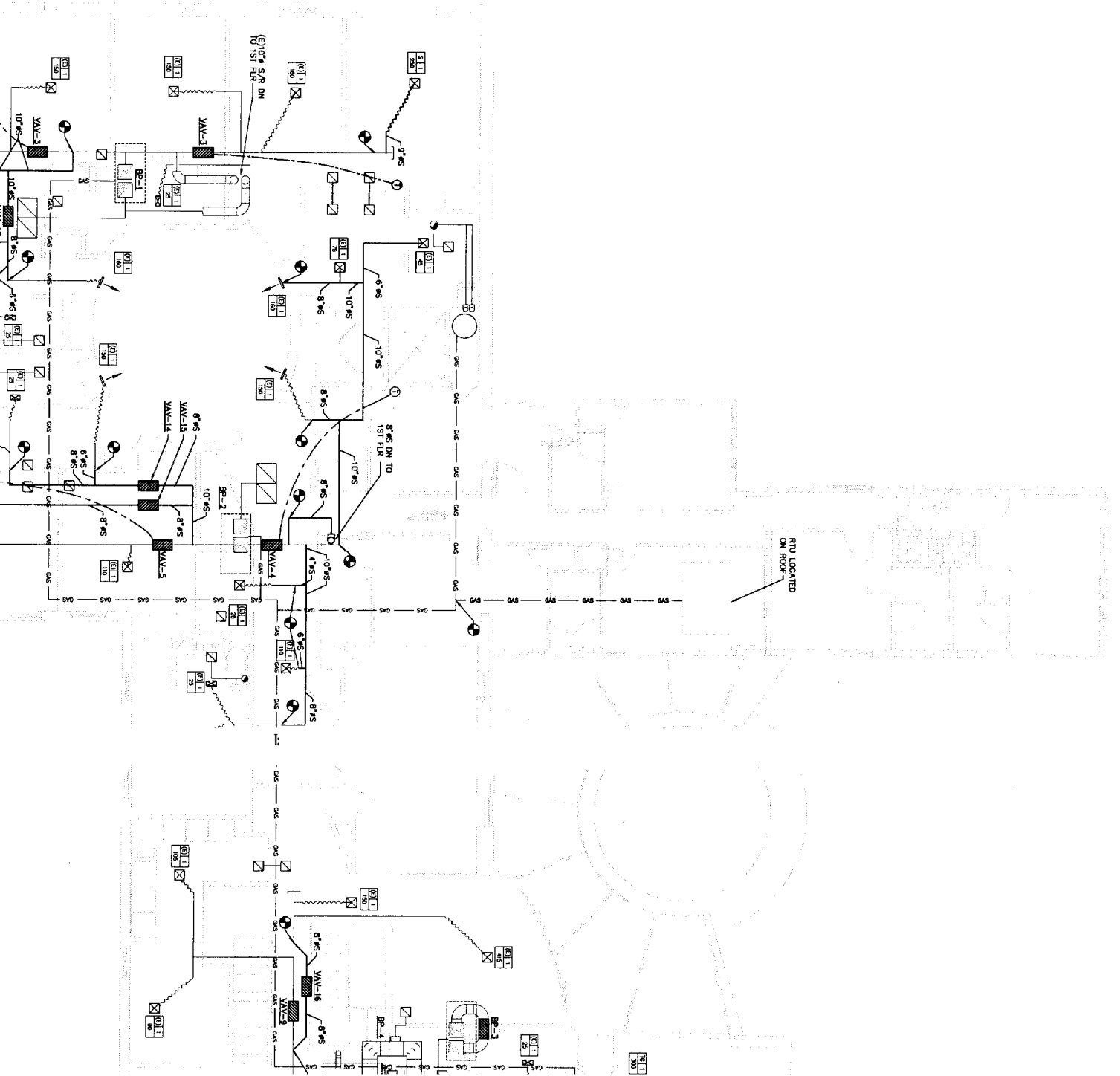

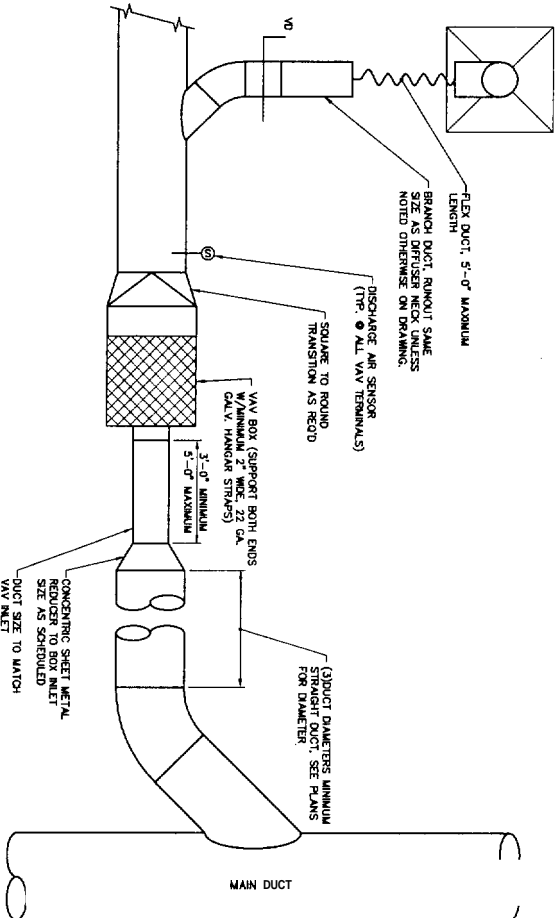
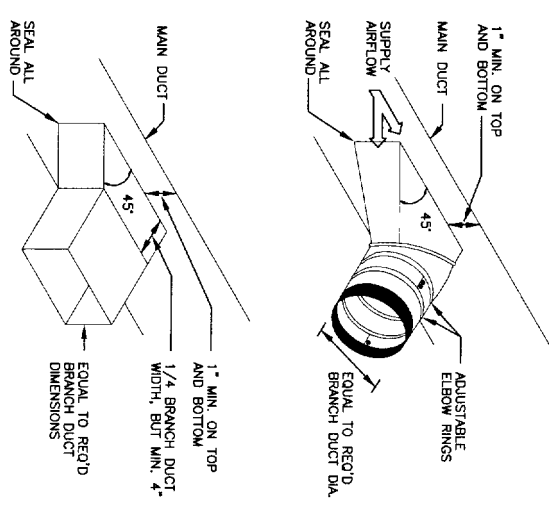

C3
NAME

7
SCALE

MAT

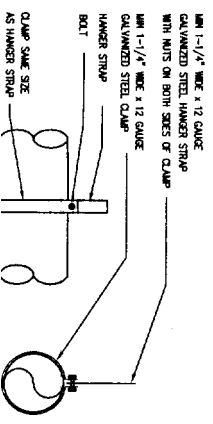
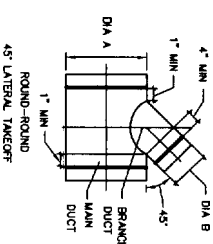
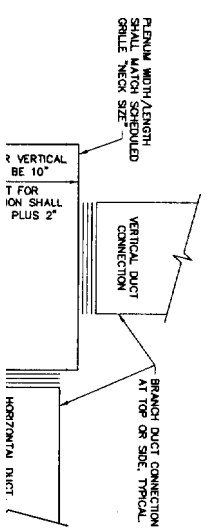

C O E F C

TAG	VA
UH-1	M
KORRES	
1. INTERNAL	
2. Eksternal	

1/	
2/	
3/	
4/	
5/	
6/	
7/	
8/	
9/	
10/	
11/	
12/	
13/	
14/	
15/	
16/	
17/	
18/	
19/	
20/	
21/	
22/	
23/	
24/	
25/	
26/	
27/	
28/	
29/	
30/	
31/	
32/	
33/	
34/	
35/	
36/	
37/	
38/	
39/	
40/	
41/	
42/	
43/	
44/	
45/	
46/	
47/	
48/	
49/	
50/	
51/	
52/	
53/	
54/	
55/	
56/	
57/	
58/	
59/	
60/	
61/	
62/	
63/	
64/	
65/	
66/	
67/	
68/	
69/	
70/	
71/	
72/	
73/	
74/	
75/	
76/	
77/	
78/	
79/	
80/	
81/	
82/	
83/	
84/	
85/	
86/	
87/	
88/	
89/	
90/	
91/	
92/	
93/	
94/	
95/	
96/	
97/	
98/	
99/	
100/	