

1 TYPICAL AUTOMATIC DOOR WIRING DETAIL  
SCALE: N.T.S.

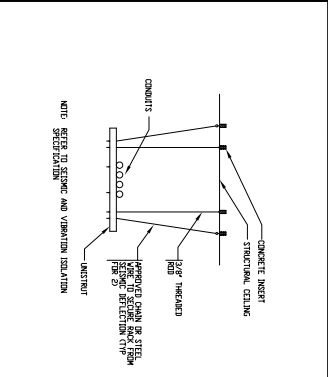

2 CONDUIT RACKING DETAIL  
SCALE: N.T.S.

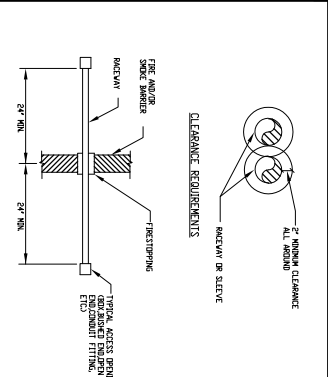

3 PENETRATION THROUGH VERTICAL FIRE AND SMOKE BARRIER DETAIL  
SCALE: N.T.S.

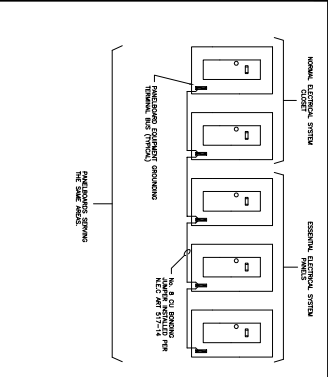

4 TYPICAL PANELBOARD BONDING DETAIL  
SCALE: N.T.S.

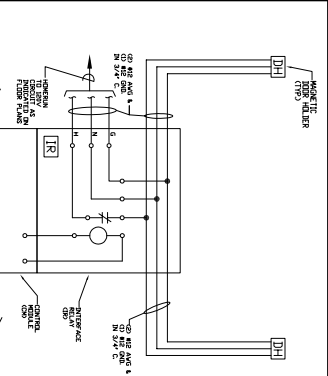

5 DOOR HOLDER WIRING DETAIL  
SCALE: N.T.S.

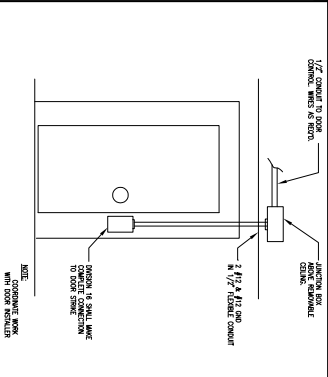

6 TYPICAL ELECTRICALLY OPERATED DOOR DETAIL  
SCALE: N.T.S.

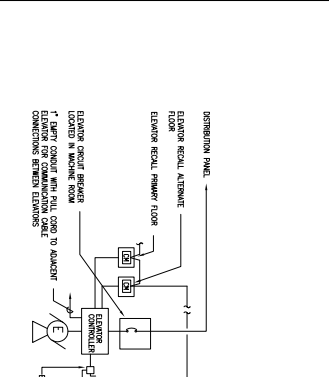

7 TYPICAL ELEVATOR INTERCONNECTION DIAGRAM  
SCALE: N.T.S.

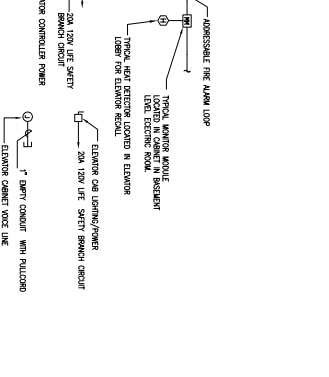

8 SMOKE DETECTION & AUTO. CONTROL AIR CONDITION AND VENTILATION SYSTEMS  
SCALE: N.T.S.

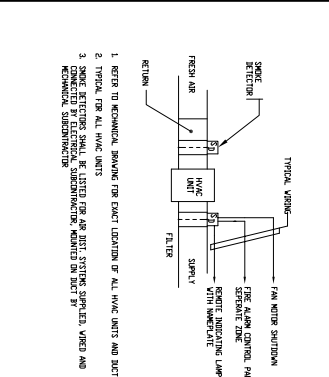

9 MOUNTED ELECTRICAL TRANSFORMER DETAIL  
SCALE: N.T.S.

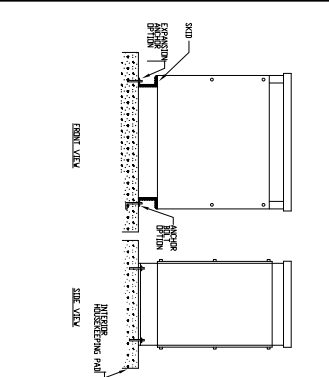

10 LIGHTING FIXTURE DETAIL  
SCALE: N.T.S.

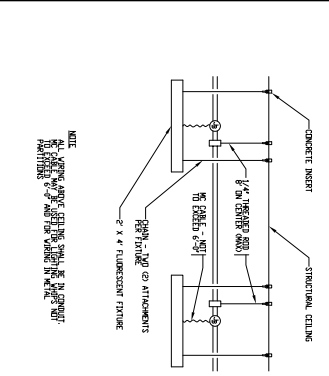

11 EQUIPMENT ROOM GROUND TERMINAL BAR DETAIL  
SCALE: N.T.S.

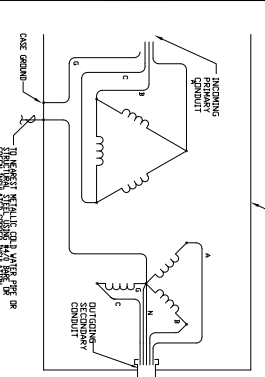

12 DRY-TYPE TRANSFORMER GROUND DETAIL  
SCALE: N.T.S.

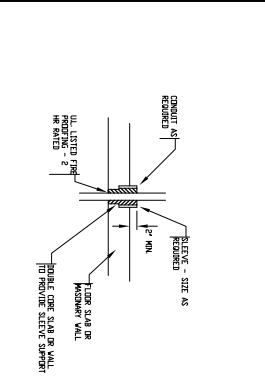

13 CORE DETAIL  
SCALE: N.T.S.

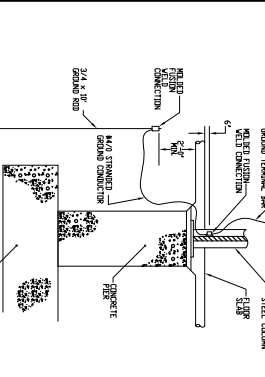

14 BUILDING GROUNDING DETAIL  
SCALE: N.T.S.

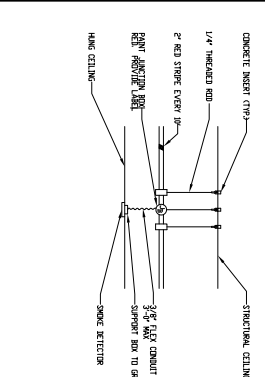

15 SMOKE DETECTOR DETAIL  
SCALE: N.T.S.

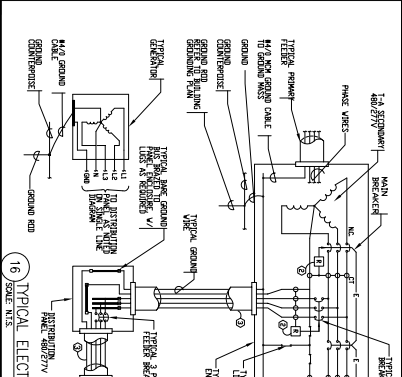

16 TYPICAL ELECTRICAL SYSTEM GROUNDING SCHEME DETAIL  
SCALE: N.T.S.

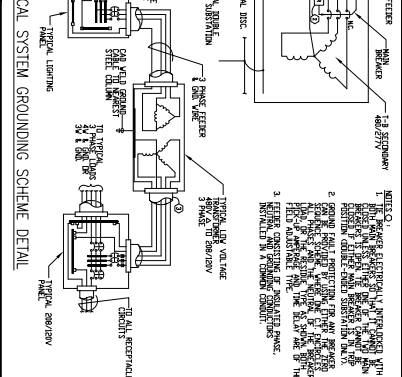

17 TYPICAL BRANCH CIRCUIT WIRING REQUIREMENTS, LIGHTING AND RECEPTACLES.  
SCALE: N.T.S.

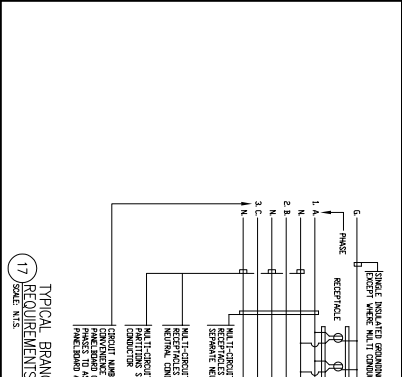

18 EMERGENCY LIGHTING SWITCHING BYPASS RELAY WIRING DIAGRAM  
SCALE: N.T.S.

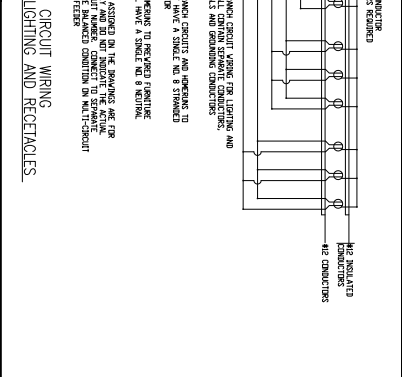

19 PENETRATION THROUGH HORIZONTAL FIRE BARRIER DETAIL  
SCALE: N.T.S.

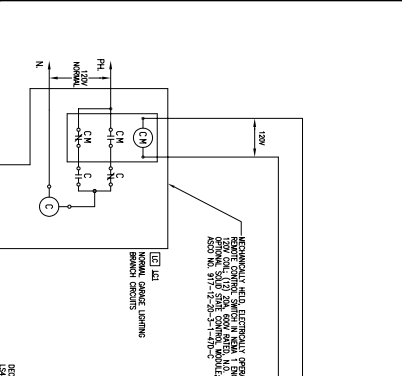

20 GARAGE LIGHTING CONTROL DIAGRAM  
SCALE: N.T.S.

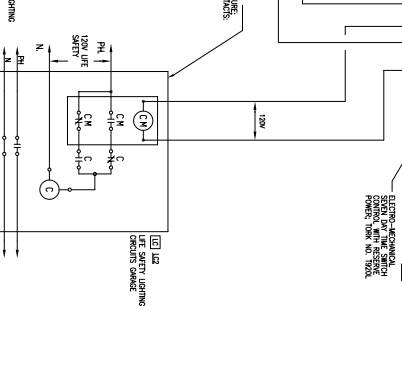

21 RECEPTACLE GROUNDING DETAIL  
SCALE: N.T.S.

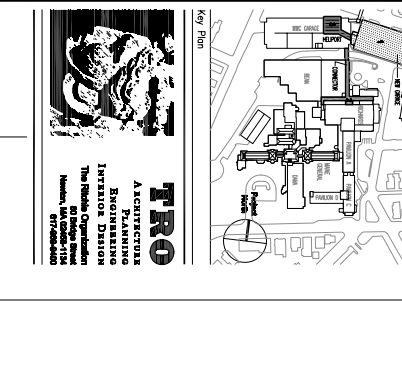

22 ELECTRICAL ROOM GROUND BAR MOUNTING DETAIL  
SCALE: N.T.S.

