

X PIPE ANCHOR DETAIL STRUCTURAL STEEL
SCALE: 1/8\"/>

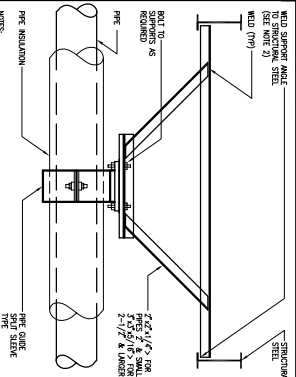

X PIPE GUIDE SUPPORT DETAIL STRUCTURAL STEEL
SCALE: 1/8\"/>

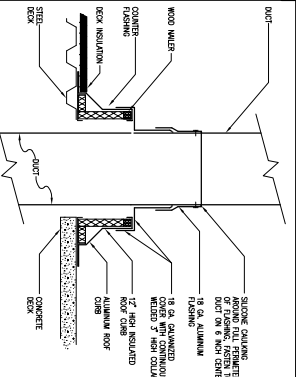

X DUCT PENETRATION THROUGH ROOF
SCALE: 1/8\"/>

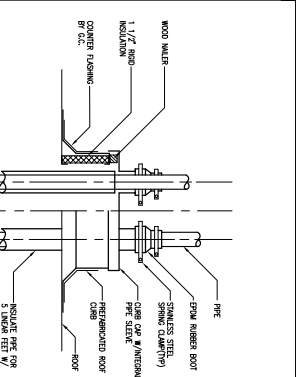

X PIPING ROOF PENETRATION
SCALE: 1/8\"/>

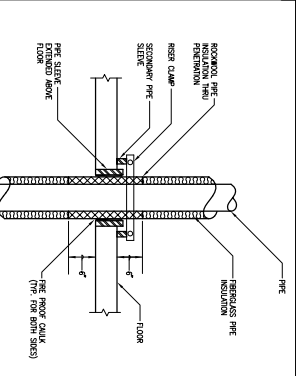

X TYPICAL FIRE RATED FLOOR PIPE PENETRATION
SCALE: 1/8\"/>

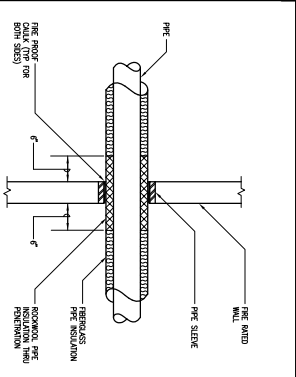

X TYPICAL FIRE-RATED WALL PIPE PENETRATION
SCALE: 1/8\"/>

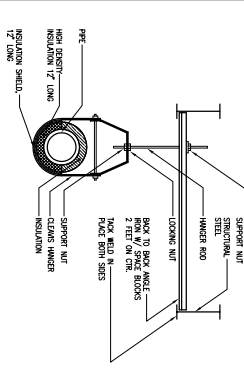

X PIPE HANGER INSTALLATION DETAIL
SCALE: 1/8\"/>

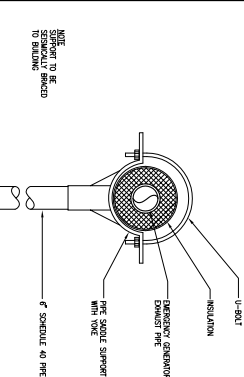

X EMERGENCY GENERATOR EXHAUST PIPE SUPPORT DETAIL
SCALE: 1/8\"/>

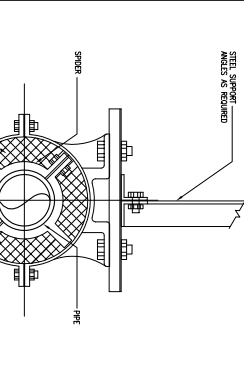

X PIPE GUIDE INSTALLATION DETAIL
SCALE: 1/8\"/>

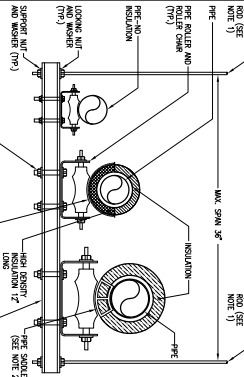

X PIPE HANGER INSTALLATION DETAIL (TRAP-TYPE)
SCALE: 1/8\"/>

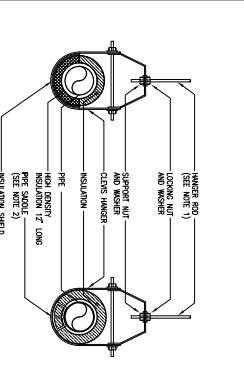

X CLEVIS TYPE PIPE HANGER INSTALLATION DETAIL
SCALE: 1/8\"/>

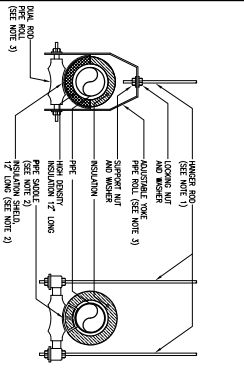

X PIPE ROLL TYPE PIPE HANGER INSTALLATION DETAIL
SCALE: 1/8\"/>

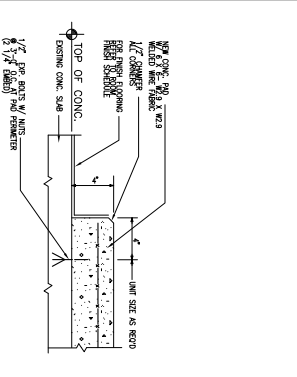

X HOUSE KEEPING PAD DETAIL
SCALE: 1/8\"/>

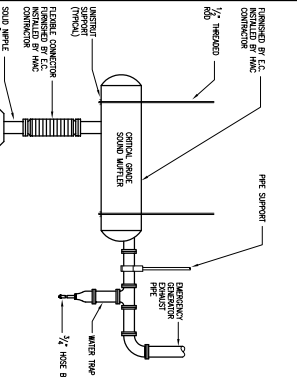

X EMERGENCY GENERATOR EXHAUST DETAIL
SCALE: 1/8\"/>

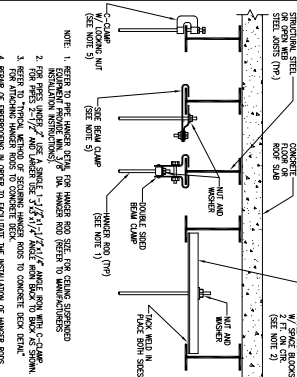

X TYPICAL METHODS OF SECURING HANGER RODS TO STRUCTURAL STEEL DETAIL
SCALE: 1/8\"/>

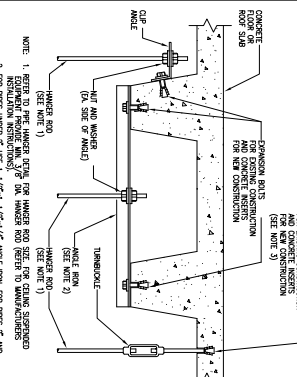

X TYPICAL METHOD OF SECURING HANGER RODS TO CONCRETE DETAIL
SCALE: 1/8\"/>

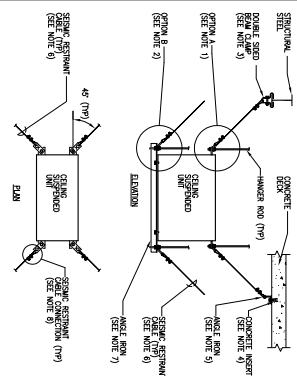

X TYPICAL SEISMIC BRACING FOR CEILING MOUNTED EQUIPMENT DETAIL
SCALE: 1/8\"/>

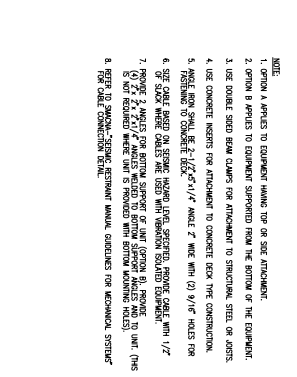

X STEAM BLOWDOWN SEPARATOR PIPING DETAIL
SCALE: 1/8\"/>

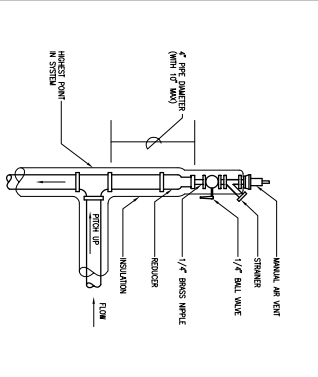

X MANUAL AIR VENT DETAIL
SCALE: 1/8\"/>

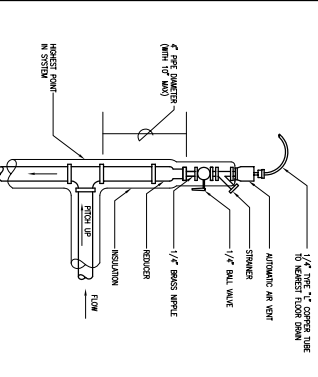

X AUTOMATIC AIR VENT DETAIL
SCALE: 1/8\"/>

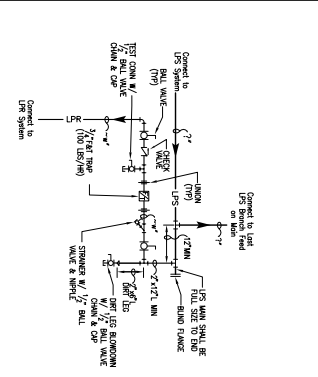

X LOW PRESSURE STEAM TRAP ASSEMBLY DETAIL
SCALE: 1/8\"/>

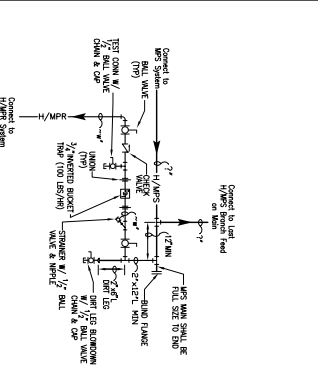

X HIGH/MEDIUM PRESSURE STEAM TRAP ASSEMBLY DETAIL
SCALE: 1/8\"/>

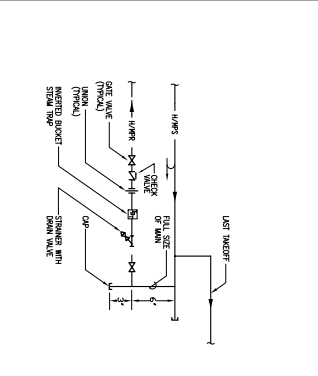

X HIGH/MEDIUM PRESSURE STEAM END OF MAIN DRIP DETAIL
SCALE: 1/8\"/>

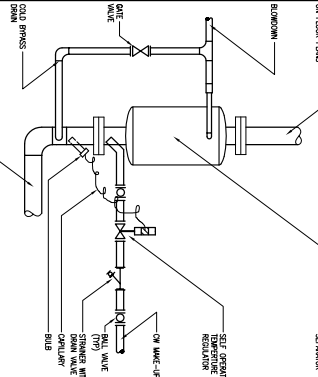

X STEAM BLOWDOWN SEPARATOR PIPING DETAIL
SCALE: 1/8\"/>

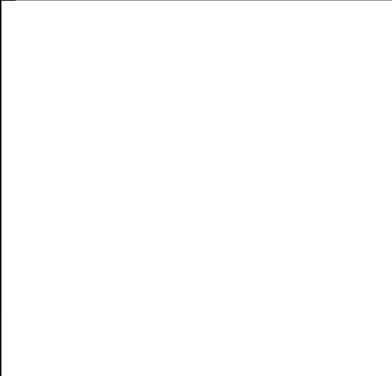
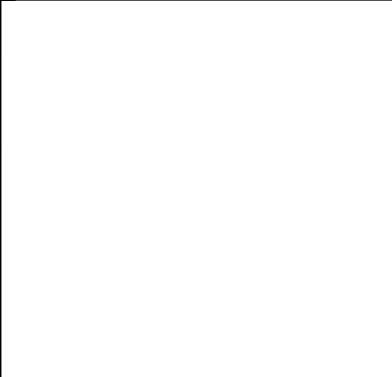

PRO ARCHITECTURE ENGINEERING PLANNING
 1175 Main Street
 Portland, Maine 04101
 Phone: 603.761.1100
 Fax: 603.761.1101
 Website: www.pro-engineers.com

Maine Medical Center
 Central Utility Plant
 Portland, Maine
MECHANICAL-CENTRAL UTILITY PLANT TYPICAL DETAILS SHEET NO. 1

SHEET NO. 1
 M601

DATE: 08/24/10
 SCALE: 1/8" = 1'-0"
 DRAWN BY: [Name]
 CHECKED BY: [Name]
 APPROVED BY: [Name]

NOT FOR PERMIT ONLY
NOT FOR CONSTRUCTION