

GLAZING SCHEDULE

GL-1	3-FORM, TING TING GAUGE 1/2" FRONT AND BACK FINISH PATINA
GL-2	MATCH EXISTING

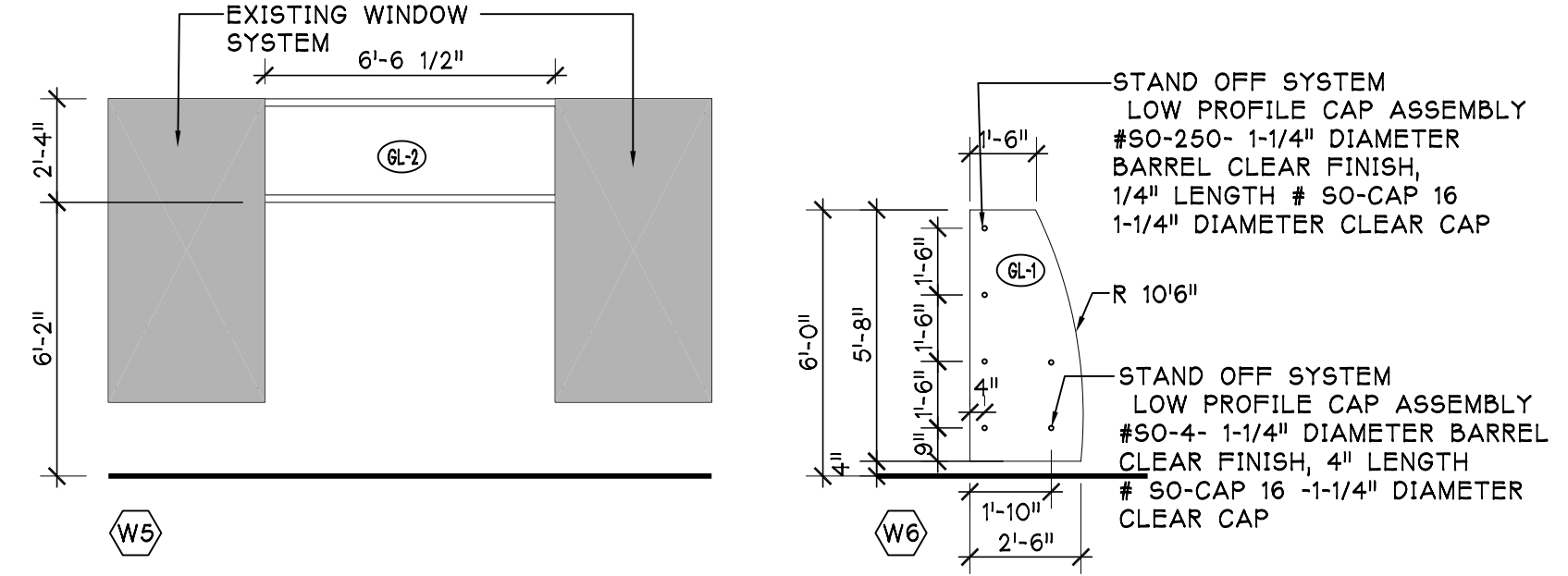

WINDOW TYPES
1/4" = 1'-0"

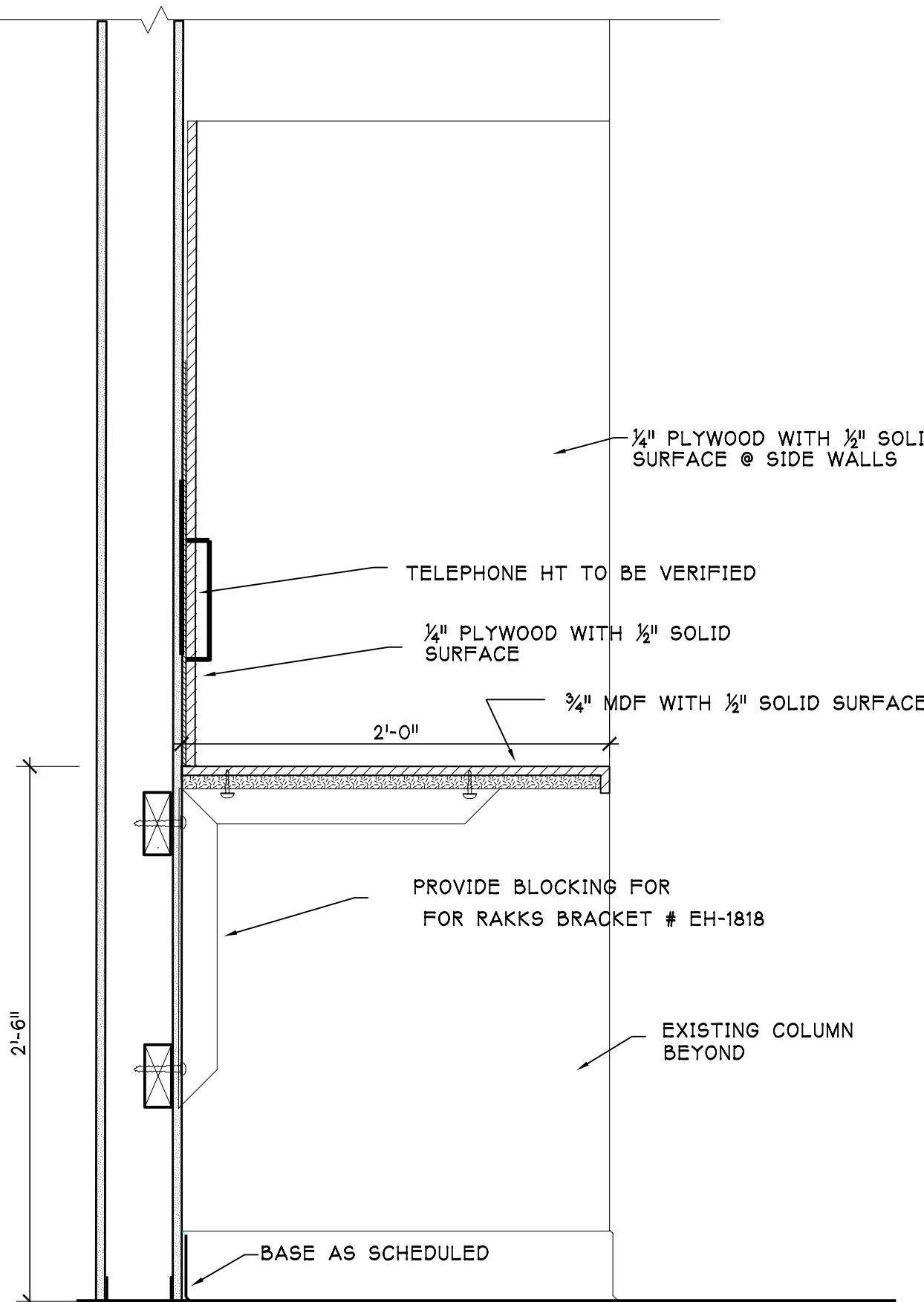

1 PHONE COUNTER
1 1/2" = 1'-0"

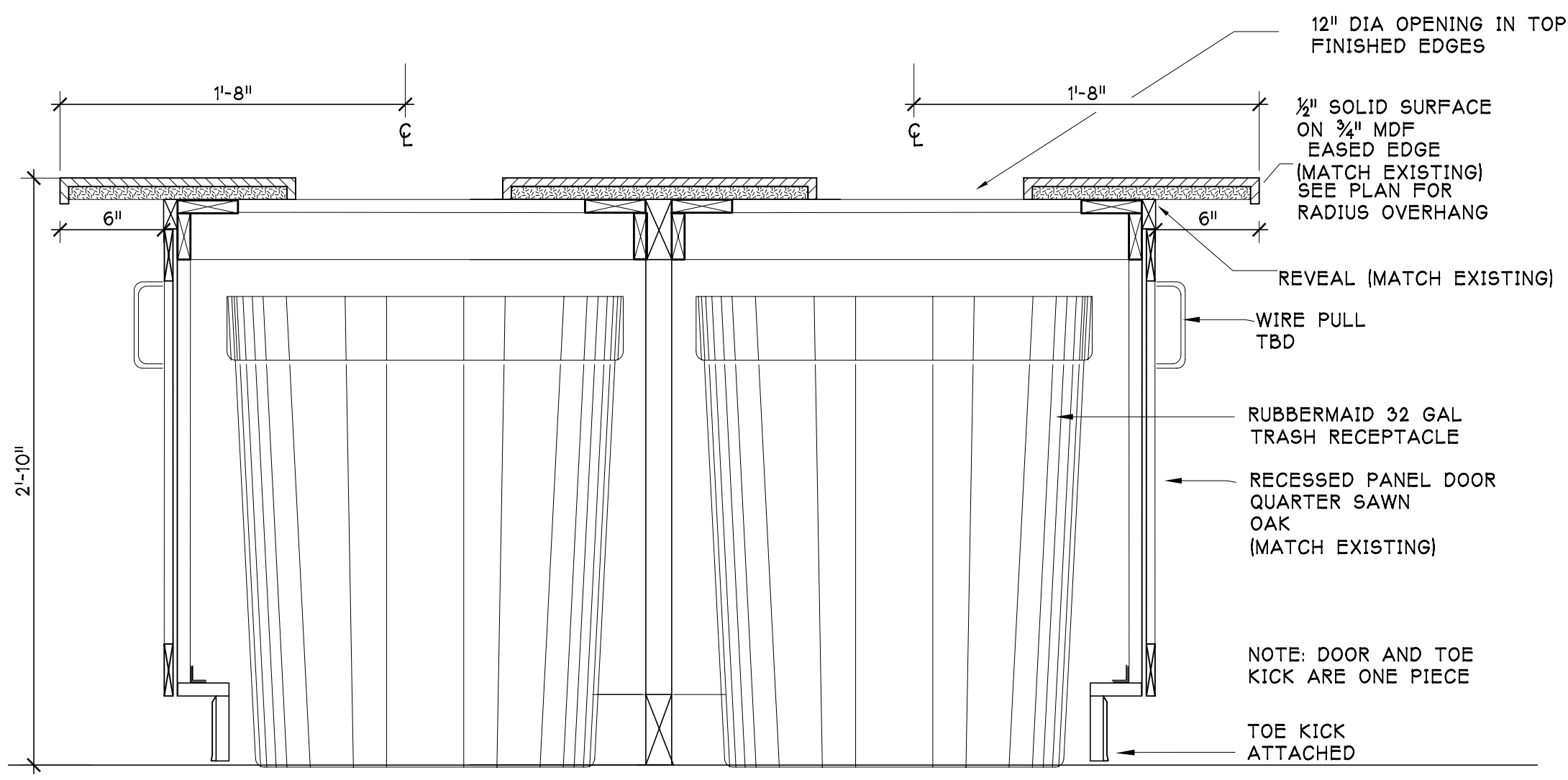

2 TRASH UNIT - FREE STANDING
1 1/2" = 1'-0"

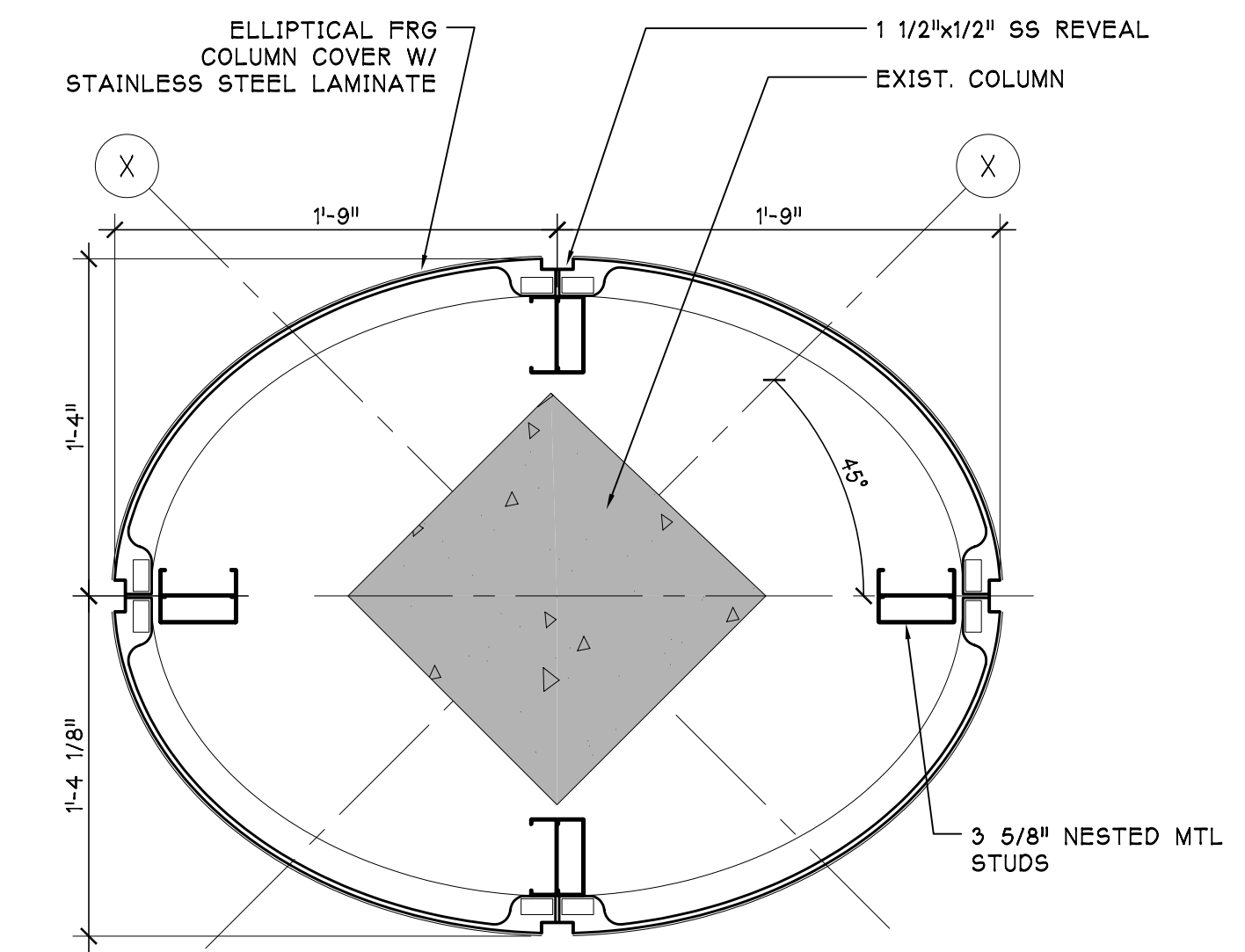

3 COLUMN DETAIL
1 1/2" = 1'-0"

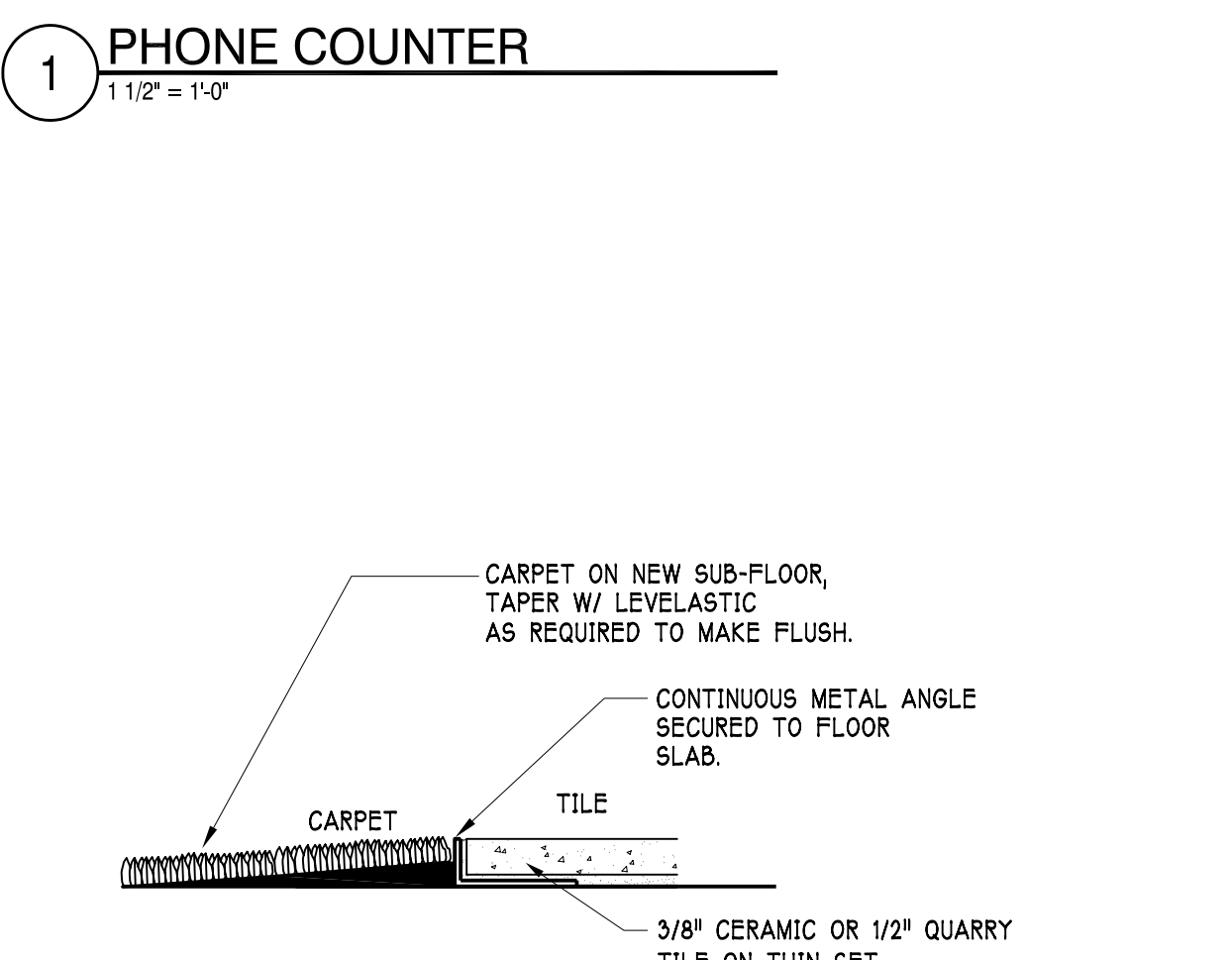

4 TRANSITION DETAIL
1 1/2" = 1'-0"

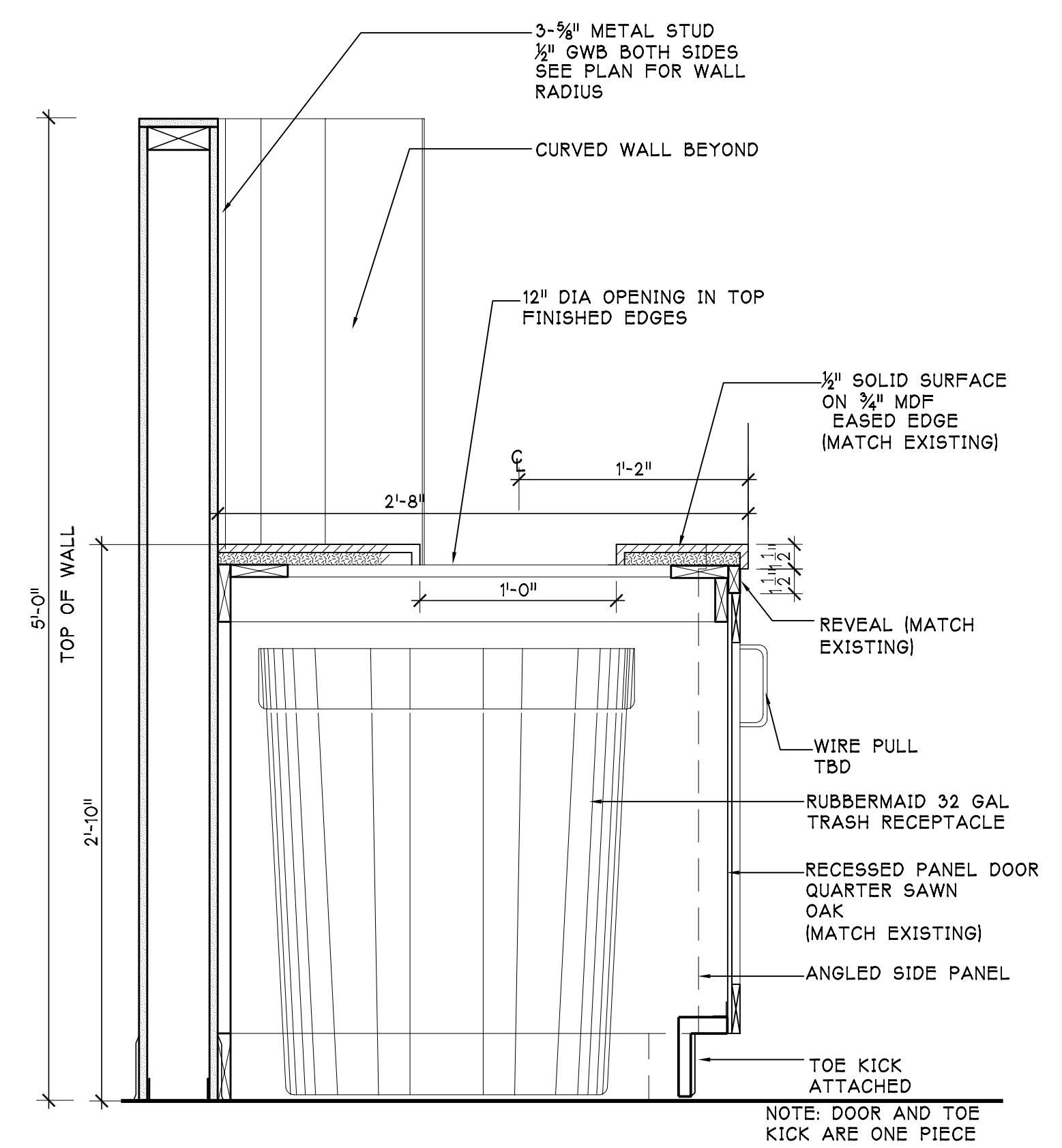

5 TRASH UNIT @ CURVED WALL
1 1/2" = 1'-0"

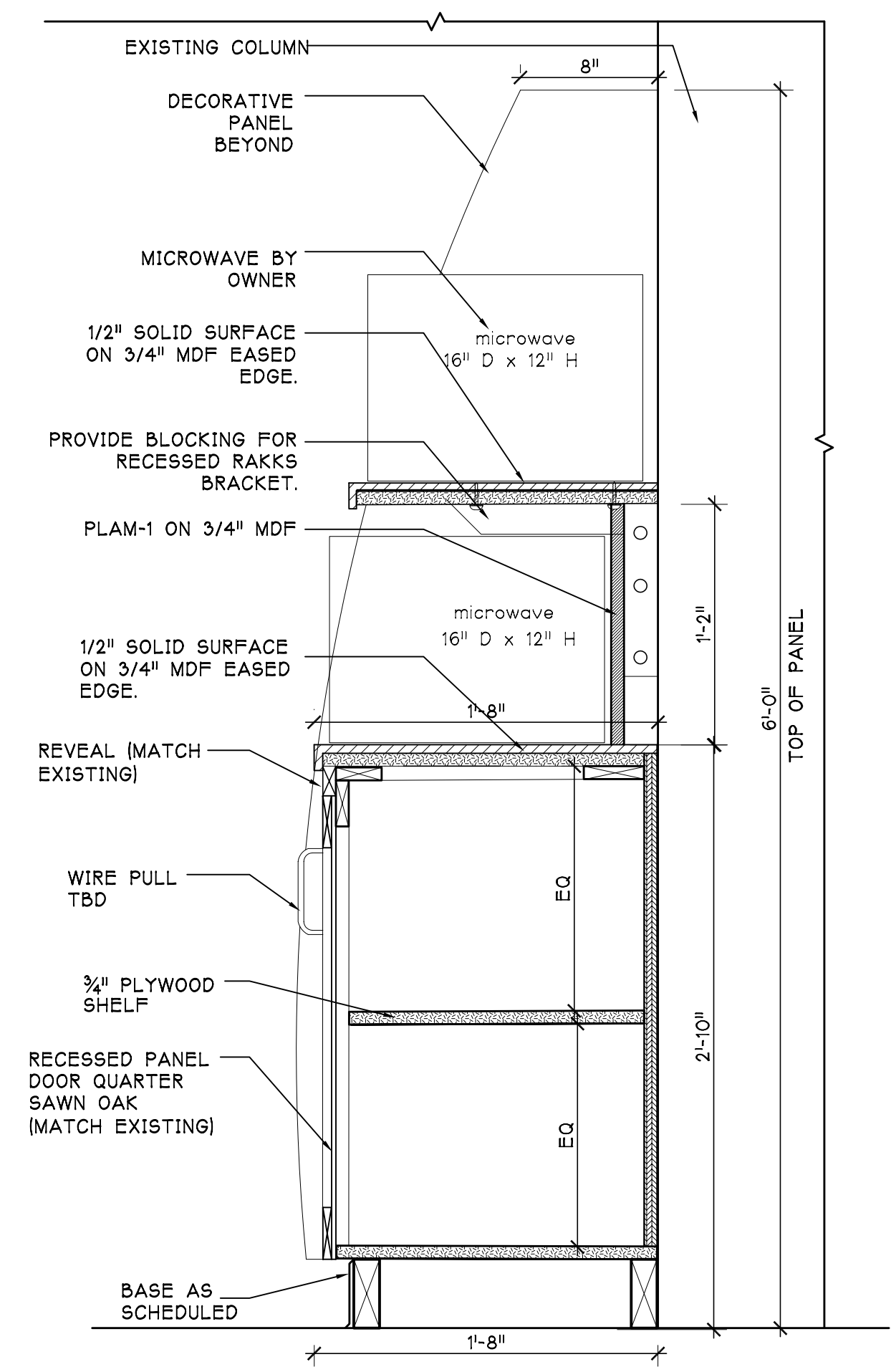

6 MICROWAVE UNIT
1 1/2" = 1'-0"

P:\P412\MMC Core\Sheets\03.01_Details.dwg Aug 22, 2007 - 4:46pm