

EXTERIOR

Exterior Wood Species

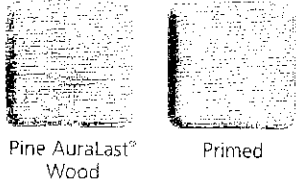

Pine Auralast[®] Wood

Primed

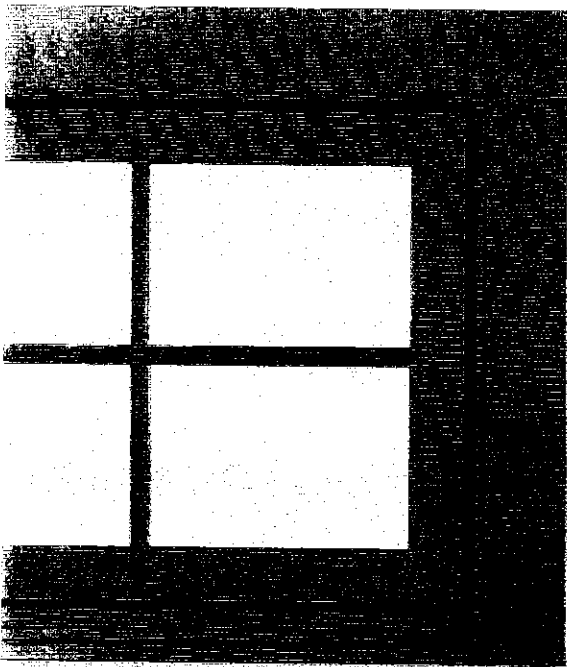

Trim Options

Primed Wood

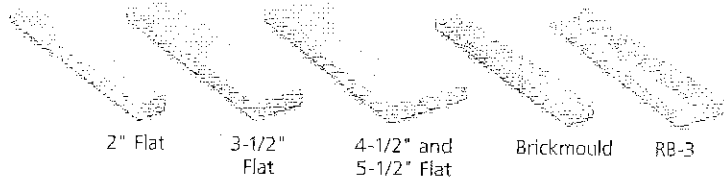

2" Flat

3-1/2" Flat

4-1/2" and 5-1/2" Flat

Brickmould

RB-3

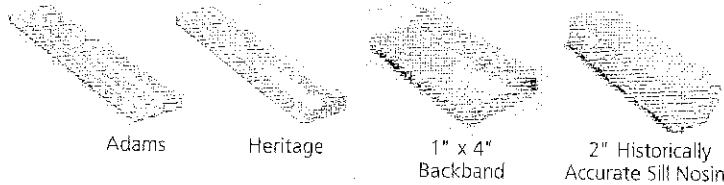

Adams

Heritage

1" x 4" Backband

2" Historically Accurate Sill Nosing

Clad



Extruded Brickmould

3-1/2" Flat

Adams

Standard Sill Nosing

1" Sill Nosing

2" Sill Nosing

Clad Colors

Our windows and patio doors with clad-wood exteriors feature protective metal cladding with a baked-on finish that doesn't need to be repainted over time. We provide a number of clad color options, so you can pick a finish that will complement your home.

Standard Clad Colors

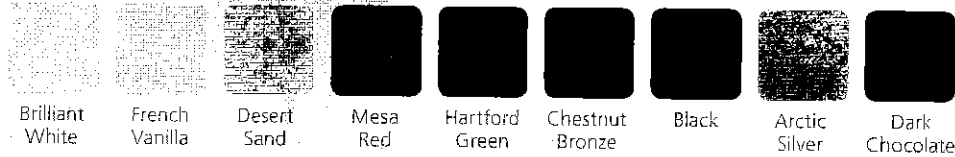

Anodized Colors



Optional Colors



Actual colors may vary from the samples displayed.

DIVIDED LITES

Add architectural interest to your JELD-WEN® Sitaline EX windows with one of our divided lite options. These options include simulated divided lites (SDL) for an authentic look, full-surround wood grilles (FS) that can be removed for easy cleaning, and maintenance-free grilles between the glass (GBG).

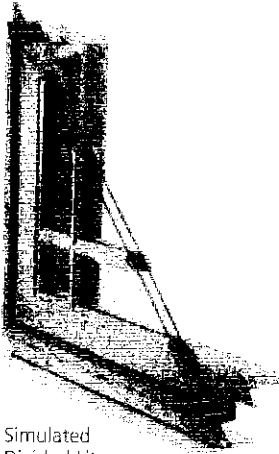

Simulated Divided Lites (SDL)

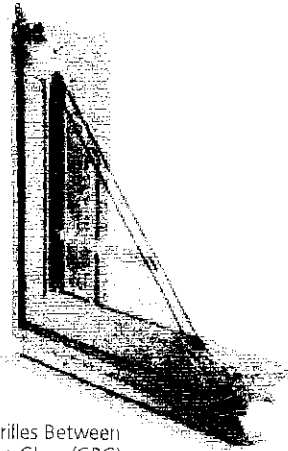

Grilles Between the Glass (GBG)

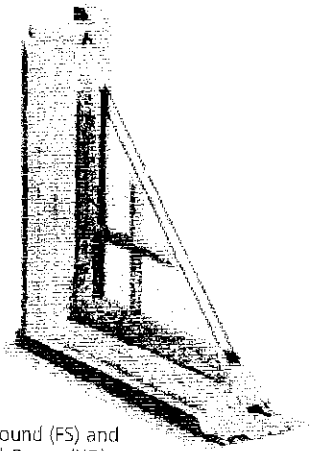

Full-Surround (FS) and Knocked-Down (KD) removable wood grilles

Simulated Divided Lites (SDL)

To achieve an authentic look, select our simulated divided lites (SDL). They feature grilles that are permanently attached to the exterior glass (aluminum for clad-wood exteriors, wood for primed wood exteriors), wood grilles adhered to the interior glass, and optional Light Brown or Silver shadow bars that are placed between the two panes of insulating glass. Grilles are available in 7/8", 1-1/8" and 1-3/8" sizes. We also offer 2-5/16" grilles for the classic look of a checkrail.

Grilles Between the Glass (GBG)

With grilles between the glass, you'll enjoy the look of divided lites without any upkeep. They are placed between the two panes of insulating glass. Select 5/8" flat or 23/32" or 1" contour metal grilles in any of our standard clad colors.

Full-Surround Wood Grilles (FS)

Our full-surround wood grilles can be removed for easy cleaning. Choose from 1-1/8", 1-3/8" or 7/8" grilles that are positioned on the interior glass surface.

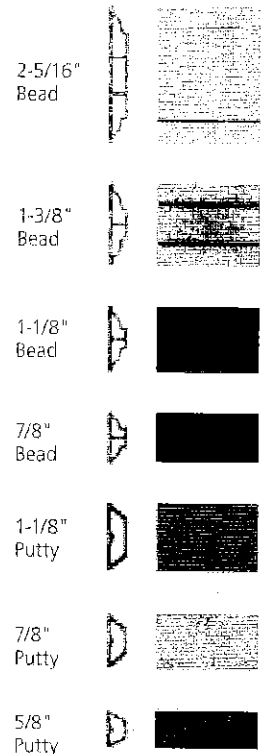

DOUBLE-HUNG WINDOWS

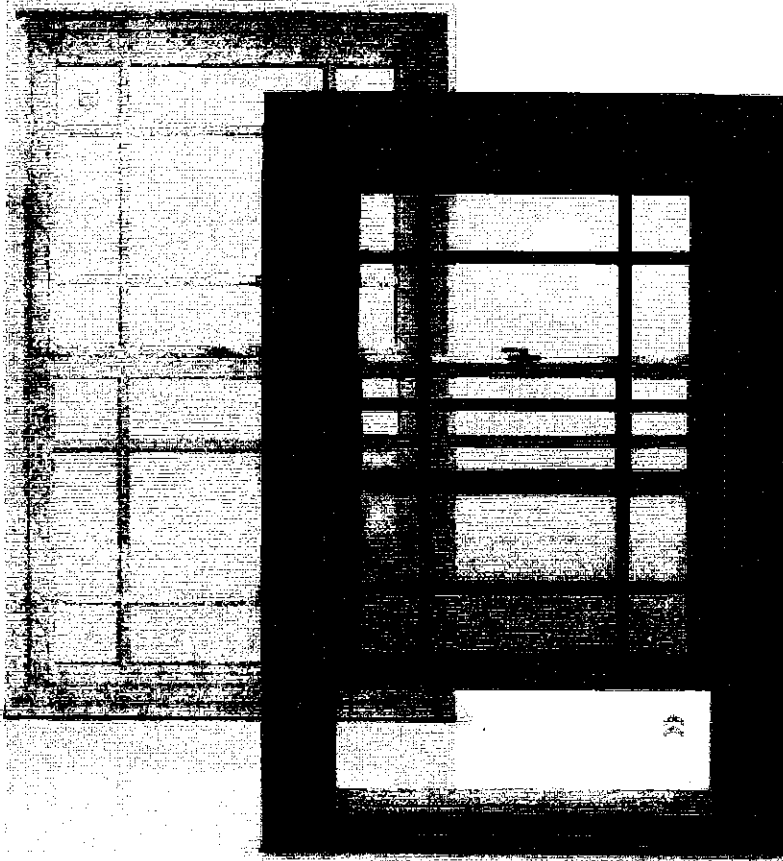

Sashlock



Sash tilt in for easy cleaning.

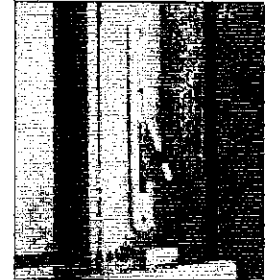

Window Opening Control Device:
Available with optional window opening control device in matching hardware finish.

These windows are best suited to traditional architectural styles. Double-hung windows feature an upper and lower sash that slide vertically past each other in a single frame. Both sashes tilt in for convenient cleaning.

Standard Hardware Finishes

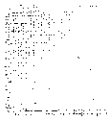

White



Desert Sand



Chestnut Bronze

Optional Hardware Finishes



Brushed Chrome



Polished Brass



Antique Brass



Oil-Rubbed Bronze

Actual colors may vary from the samples displayed.

PRODUCT SPECIFICATIONS**EXTERIOR FINISH**

All exterior surfaces are covered with a factory-applied latex primer.

AURALAST® WOOD

AuraLast® wood is fundamentally different from wood resulting from traditional millwork preservation processes in that it uses a proprietary vacuum/pressure process to provide protection throughout the wood parts used to make windows and doors. AuraLast® wood is distinguished from wood using the current preservation methods by its unique ability to achieve greater penetration of the active ingredients into the wood parts, with a penetration of the treatment being a minimum of 92%.

INTERIOR FINISH

All interior surfaces are unfinished clear pine ready for on site finishing. Primed and pre-finished interiors are available in paint: Pure White, Extra White, Natural Choice, Moderate White; in stain: Wheat, Cherry, Fruitwood, Cordovan, Cider and Clear Lacquer.

FRAME

Frame is assembled from select kiln dried pine using AuraLast® wood on all exterior parts. Frame corner joints are tightly secured with metal fasteners and adhesive. Frame thickness is 1-1/16" (17.5mm) at head, side jamb and sill. Basic jamb width is 4-9/16" (116mm) and may be extended for different wall depths. Finished frame has exterior casing, sill nosing, weather-stripping, hardware, and interior stops applied.

SASH

Sash is 1-7/16" (36.5mm) thick select kiln-dried pine using AuraLast® wood. Stiles and rails are mortise and tenoned, machine clamped for squareness and secured with metal fasteners. The glass is mounted into the sash using a silicone-glazing compound on the exterior and acrylic sealant on the interior, then secured with interior applied profiled wood stops. Sash operate in a non-compression ivory colored jamb liner that allows both top and bottom sash to tilt inside for easy cleaning and removal without the use of tools. No finger plow sash available on venting units.

GLAZING

3/4" (19mm) thick sealed insulating glass is constructed from two panes of glass, utilizing a continuous roll formed stainless steel spacer with dual seal sealant. The glass is mounted into the sash using a silicone-glazing compound and secured with interior applied profiled wood stops. All insulating glass units comply with the performance requirements of IGCC in accordance with either ASTM E774 or E2190.

GLAZING OPTIONS

3/4" insulating glass available in Low-E with Argon, Low-E, Low-E 366, Clear, Neat Glass, reflective, tinted, or obscure, tempered or other specialty glass as specified. Preserve® film is a 0.003" thick polyethylene film with a low tack acrylic adhesive applied to the glass for protection during shipping and installation. 4,000 foot elevations and higher require a capillary tube to equalize environmental stress (otherwise known as High Altitude glazing). High Altitude glazing does not allow the use of Argon as listed under glazing options.

WEATHER-STRIPPING

Engineered system combines PVC ivory jamb liner with dual bulb weather-stripping at head. Checkrail features thermoplastic rubber bulb and recessed cam action sash lock for secure closure. Rigid vinyl water stops at sill provide additional restraint against weather.

HARDWARE

Sash operate by means of a dual block and tackle balance system with nylon roller pulleys and high-tension coil springs. Balance system gauged to sash weight and uses pre-stretched dacron cords attached to clutch mechanisms to insure smooth, operation and compliance with operating force requirements. Jamb liners are Ivory (White is optional). Recessed cam action sash lock is available in White, Chestnut Bronze, Desert Sand or optional Bright Brass, Antique Brass, Polished Brass, Brushed Chrome or Imitation Oil Rubbed Bronze. 28" glass width and larger units have two sash locks. Optional Lexan sash lift available for no finger plow sash.

EXTERIOR INSECT SCREENS

Charcoal fiberglass screen cloth (18x16 mesh) set in painted roll formed aluminum frame with color to match cladding - choice of Brilliant White, Chestnut Bronze, Desert Sand, French Vanilla, Hartford Green, Mesa Red, Black, Arctic Silver or Dark Chocolate, installed in channel on frame extrusion and held in place with spring loaded plungers at the top and sides of screen. Aluminum mesh and Phantom screen also available. Insect screens are intended to allow air and light in and to keep insects out. They are not intended to keep anyone or anything from falling through an open window. For safety screens or other security devices contact your local building supply retailer.

GRILLES

SDL (Simulated Divided Lites) - wood muntins permanently applied to the exterior of the insulating glass unit (not available on textured glass) in 7/8" (22mm), 1-1/8" (28.5mm), or 1-3/8" (34.9mm) widths, and a putty profile in 5/8" (15.9mm), 7/8" (22mm) and 1-1/8" (28.5mm) widths only. SDL is standard with a light bronze internal shadow bar to give a true divided lite appearance. As an option, SDL may be ordered with a silver shadow bar. Clear wood interior muntin bars match the exterior muntin width and are permanently bonded to the interior of the glass. Also available is a 2-5/16" (59mm) SDL bar, which simulates a double-hung checkrail.

Full Surround Wood Grilles - Rectangular unfinished clear pine wood grilles in 7/8" (22mm), 1-1/8" (28.6mm) and 1-3/8" (35mm) are available in patterns selected by the owner.

GBG (Grilles between the Glass) - 5/8" (15.9mm) flat and 23/32" or 1" contour mounted between the glass panes suspended within the air cavity.

EXTERIOR TRIM

1-3/32" (27.8mm) x 2" (50.8mm) brickmould with 1-1/16" (27mm) x 1-3/4" (44.5mm) nosing is standard. Flat casing is available as 1-3/32" (27.8mm) x 2" (50.8mm), 1-3/32" (27.8mm) x 3-1/2" (89mm), 1-3/32" (27.8mm) x 4-1/2" (114.3mm), and 1-3/32" (27.8mm) x 5-1/2" (139.7mm). The following profiled casings are available: RB-3 and Adams as 1-1/16" x 3-1/2" (89mm), and Williamsburg 1-3/16" x 3-1/4". Historical wood sill nosing 1-3/4" (44.5mm) and 2-13/16" (71.4mm) is also available.

Continued on next page

QUICK SPEC GUIDE

SPECIFICATION	STANDARD FEATURES	OPTIONAL FEATURES <i>Some options may require additional lead times. Consult your JELD-WEN Sales Representative.</i>
FRAME	<ul style="list-style-type: none"> Fingerjoint Wood 	
EXTERIOR FINISH	<ul style="list-style-type: none"> Primed 	<ul style="list-style-type: none"> Natural
EXTERIOR TRIM	<ul style="list-style-type: none"> 1-3/32" Brickmould Wood Sill Nose Drip Cap 	<ul style="list-style-type: none"> Flat Casing: 1-3/32" x 2", 3-1/2", 4-1/2", and 5-1/2" Heritage Casing: 1-3/16" x 3-1/4" Adams Casing: 1-1/16" x 3-1/2" RB3 Casing: 1-1/16" x 3-1/12" 1-7/32" x 4-1/2" Backband No Brickmould Option Historical Sill Nose Clad Metal Drip Cap (White only)
INTERIOR FINISH	<ul style="list-style-type: none"> Natural 	<ul style="list-style-type: none"> Priming Available <p>Pre-finished Interior Options are:</p> <ul style="list-style-type: none"> Paint - Pure White, Extra White, Natural Choice, Moderate White Stain - Wheat, Fruitwood, Cherry, Cordovan, Cider Clear Lacquer
SIZE	<ul style="list-style-type: none"> Width: Venting Double-Hung: 21-3/8, 25-3/8, 29-3/8, 31-3/8, 33-3/8, 37-3/8, 41-3/8, 45-3/8 Picture Double-Hung: 21-3/8, 25-3/8, 29-3/8, 31-3/8, 33-3/8, 37-3/8, 41-3/8, 45-3/8, 49-3/8, 53-3/8, 61-3/8, 69-3/8, 77-3/8 Height: Venting Double-Hung: 32, 36, 40, 44, 48, 52, 56, 60, 64, 68, 72, 76, 80, 88, 92 Picture Double-Hung: 15, 18, 24, 32, 36, 40, 44, 48, 52, 56, 60, 64, 68, 72, 76, 80, 88, 92 For RO, add 3/4" 	<ul style="list-style-type: none"> Width: Venting Double-Hung: Minimum: 16" Maximum: 45-3/8" Picture Double-Hung: Minimum: 16" Maximum: 77-3/8" Fixed Units over 49-3/8" wide can be up to 80" high Fixed Units up to 49-3/8" wide can be up to 92" high Height: Venting Double-Hung: Minimum: 28" Maximum: 92" * * glass can't exceed 42" high Picture Double-Hung: Minimum: 15" Maximum: 92" Fixed Units over 49-3/8" wide can be up to 80" high Fixed Units up to 49-3/8" wide can be up to 92" high For RO, add 3/4"
GLAZING	<ul style="list-style-type: none"> Low-E Insulating Glass Preserve® Protective Film 	<ul style="list-style-type: none"> Clear Obscure Bronze Low-E 366 Neat Glass Dual Low-E Reflective Tempered High Altitude

Continued on next page

QUICK SPEC GUIDE

SPECIFICATION	STANDARD FEATURES	OPTIONAL FEATURES <i>Some options may require additional lead times. Consult your JELD-WEN Sales Representative.</i>
GRILLES		<ul style="list-style-type: none"> • 5/8" Flat, 23/32" or 1" Contour GBG • 7/8", 1-1/8", 1-3/8" Full Surround Wood Grilles SDL Bead Profile: <ul style="list-style-type: none"> • 7/8", 1-1/8", 1-3/8", 2-5/16" with Light Bronze Shadow Bar • 7/8", 1-1/8", 1-3/8", 2-5/16" with Silver Shadow Bar SDL Putty Profile: <ul style="list-style-type: none"> • 5/8", 7/8", 1-1/8" with Light Bronze Shadow Bar • 5/8", 7/8", 1-1/8" with Silver Shadow Bar
HARDWARE	<ul style="list-style-type: none"> • Balance: Dual Block and Tackle • Cam Locks • Ivory Jamb Liners (standard) 	<ul style="list-style-type: none"> • White
HARDWARE COLOR	<ul style="list-style-type: none"> • White • Desert Sand • Chestnut Bronze 	<ul style="list-style-type: none"> <li style="width: 50%;">• Antique Brass <li style="width: 50%;">• Brushed Chrome <li style="width: 50%;">• Polished Brass <li style="width: 50%;">• Oil Rubbed Bronze
JAMB	<ul style="list-style-type: none"> • 4-9/16" 	<ul style="list-style-type: none"> • Minimum: 4-9/16" • Maximum: 9-5/16" (one piece) • Maximum: 12" (two piece)
SCREENS	<ul style="list-style-type: none"> • BetterVue™ 	<ul style="list-style-type: none"> • Aluminum Mesh available • Phantom Screen - Limitations apply, factory-applied • UltraVue™
SCREEN FRAME COLOR	<ul style="list-style-type: none"> <li style="width: 50%;">• Brilliant White <li style="width: 50%;">• Hartford Green <li style="width: 50%;">• Chestnut Bronze <li style="width: 50%;">• Black <li style="width: 50%;">• Desert Sand <li style="width: 50%;">• Arctic Silver <li style="width: 50%;">• French Vanilla <li style="width: 50%;">• Dark Chocolate <li style="width: 50%;">• Mesa Red 	<ul style="list-style-type: none"> <li style="width: 50%;">• Bronze <li style="width: 50%;">• Hunter Green <li style="width: 50%;">• Heirloom White <li style="width: 50%;">• Sage Brown <li style="width: 50%;">• Bone White <li style="width: 50%;">• Redwood <li style="width: 50%;">• Dark Buckskin <li style="width: 50%;">• Sea Foam <li style="width: 50%;">• Smoke <li style="width: 50%;">• Ivory <li style="width: 50%;">• Mocha Cream <li style="width: 50%;">• Cascade

ELEVATION NOTES
DOUBLE-HUNG

ELEVATION DRAWINGS UTILIZE A LIMITED NUMBER OF PROJECTED LINES TO PRODUCE A RUDIMENTARY DRAWING INTENDED TO BE USED IN A SMALL GRAPHICAL SCALE. ELEVATIONS ARE VIEWED PERPENDICULAR FROM THE EXTERIOR OF THE STRUCTURE. IF MORE DIMENSIONS ARE NEEDED, USE THE SECTION DRAWINGS FOR MORE COMPLETE DEPICTIONS.

M.O. Brickmould
M.O. Adams/Flat Casing
Rough Opening
Frame Size
Daylight Opening

24 1/2" (622)
27 1/2" (699)
22 1/8" (562)
21 3/8" (543)
14 13/16" (376)

Masonry Openings for Brickmould, Flat & Adams Casing.
Vertical measurements include sillnose.
(Subtract 1/2" from Masonry Opening for Unit Size)

34 11/16" (881)
36 3/16" (919)
32 3/4" (832)
32" (813)
11 1/16" (281) [2]

DAYLIGHT OPENING

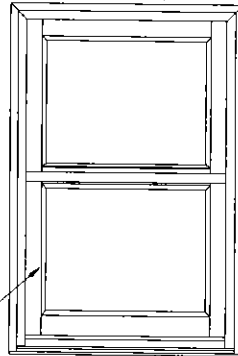

OUTSIDE OF
EXTERIOR TRIM

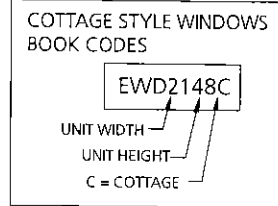

EWD2132

'EWD' INDICATES
SITELINE EX WOOD DOUBLE-HUNG

THE FIRST TWO NUMBERS
INDICATE THE UNIT WIDTH

BOOK CODE

THE LAST TWO NUMBERS INDICATE
THE UNIT HEIGHT

GENERAL WOOD DOUBLE-HUNG NOTES

1. ALL UNITS SHOWN ARE AVAILABLE AS OPERATORS ONLY.
2. UNIT ELEVATIONS ARE SHOWN WITH BRICKMOULD & SILL NOSE.
3. ALL OPERATING SASH ARE INSTALLED WITH VINYL JAMB LINERS AND OPERATED WITH AN INTERNAL BLOCK AND TACKLE SPRING SYSTEM.
4. DIMENSIONAL VALUES IN PARENTHESES ARE MILLIMETER CONVERSIONS.
5. VALUES IN BRACKETS ARE NUMBER OF DAYLIGHT OPENINGS.

ELEVATION SYMBOL LEGEND:

MO MASONRY OPENING

DIVIDED LITE OPTIONS

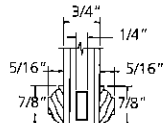

7/8" SDL

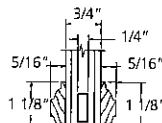

1 1/8" SDL

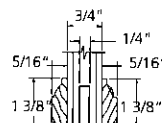

1 3/8" SDL

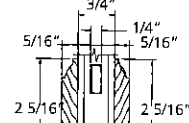

2 5/16" SDL

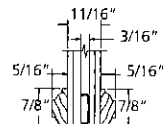

7/8" SDL

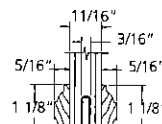

1 1/8" SDL

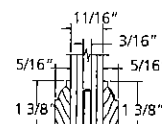

1 3/8" SDL

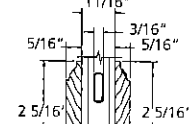

2 5/16" SDL

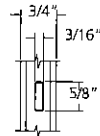

5/8" GRILLE

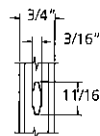

23/32" GRILLE

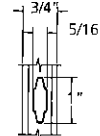

1" GRILLE

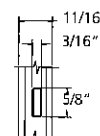

5/8" GRILLE

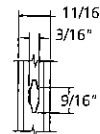

23/32" GRILLE

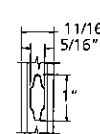

1" GRILLE

GRILLES MEETING

NFRC 3mm RULE

GRILLE PROFILES:

3/16" x 5/8"	ALLMETAL 1021101018XX140
3/16" x 1"	ALLMETAL 1020101018XX164
1/4" x 5/8"	ALLMETAL 1020102018XX140
1/4" x 1"	ALLMETAL 1020102018XX164
5.5mm x 18mm CONTOUR	ALLMETAL 1020301010XX255
8mm x 25mm CONTOUR	ALLMETAL 1020301018XX380

Note: All glass and airspace dimensions per current cardinal glass specs. Lites with shapes, angles or radii outside the Lisec Bender capabilities for stainless steel warm edge spacer will have aluminum box spacer with the same airspace dimension shown here.

SCALE 3" = 1'

**UNIT SIZING, ROUGH OPENINGS
& MASONRY OPENINGS
DOUBLE-HUNG**

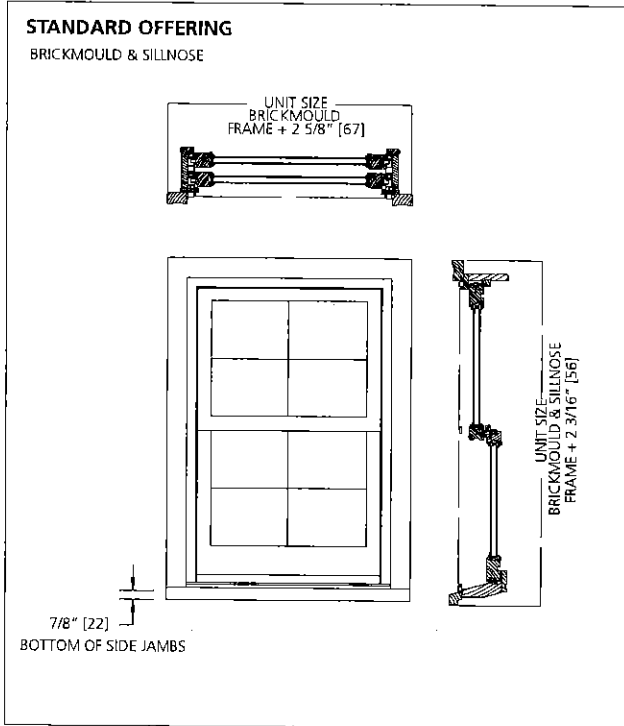

GENERAL NOTES:

UNITS WITH NO TRIM AND SILL NOSE:
UNIT SIZE = FRAME SIZE

UNIT SIZE IS ALWAYS THE
EXTREME SIZE OF THE WINDOW
WITH OR WITHOUT TRIM

MASONRY OPENING:
MASONRY OPENING IS ALWAYS 1/2" OVER
THE UNIT SIZE OF THE WINDOW

ROUGH OPENING:

ROUGH OPENING IS ALWAYS 3/4" OVER
FRAME SIZE OF THE WINDOW

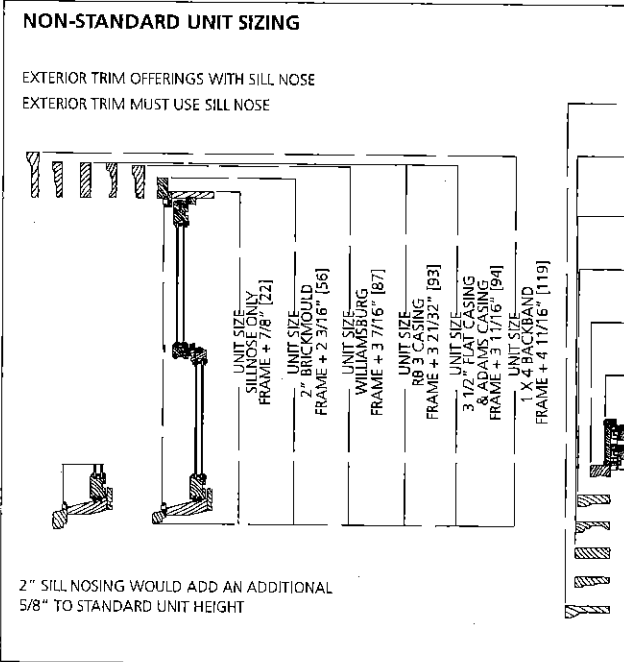
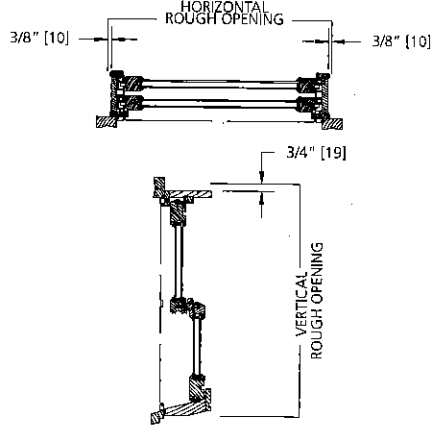

**FRAME TO TRIM
DIMENSIONS**

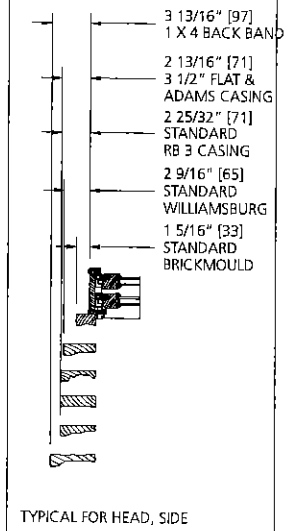

**UNIT SIZING, ROUGH OPENINGS
& MASONRY OPENINGS
SECTOR TOP SINGLE-HUNG**

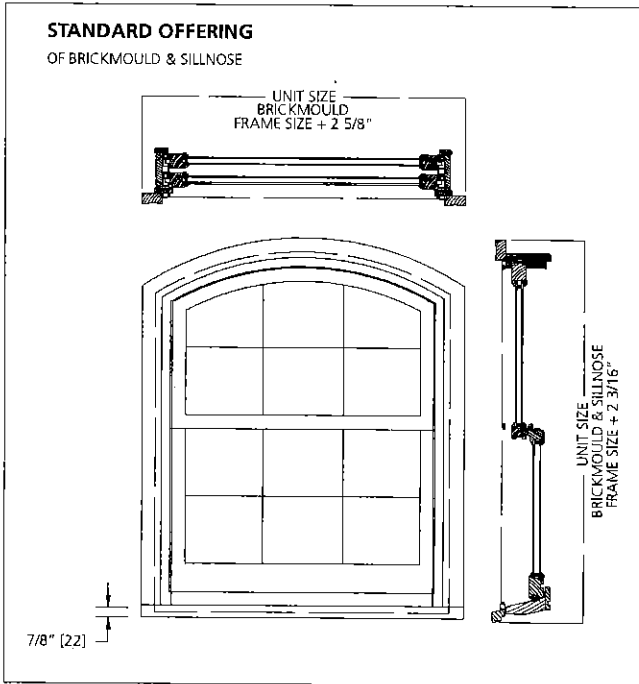

GENERAL NOTES:

UNITS WITH NO TRIM AND SILL NOSE:
UNIT SIZE = FRAME SIZE
UNIT SIZE IS ALWAYS THE
EXTREME SIZE OF THE WINDOW
WITH OR WITHOUT TRIM

MASONRY OPENING:
MASONRY OPENING IS ALWAYS 1/2" OVER
THE UNIT SIZE OF THE WINDOW

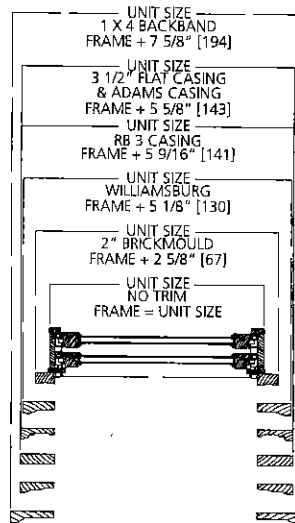
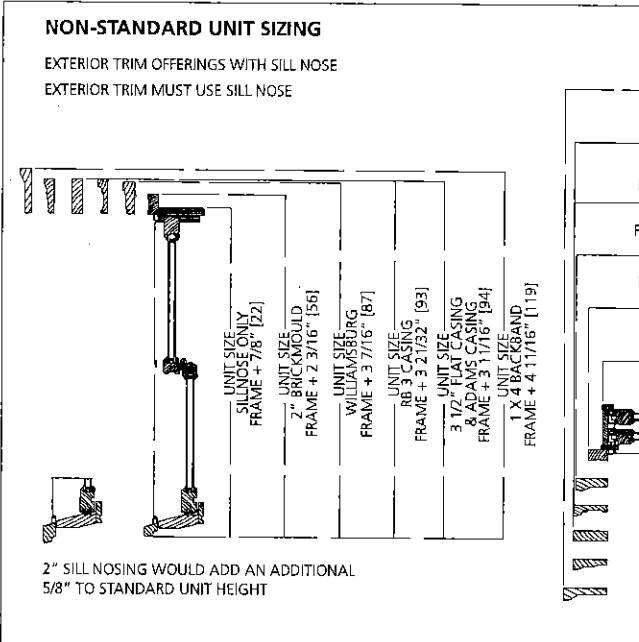
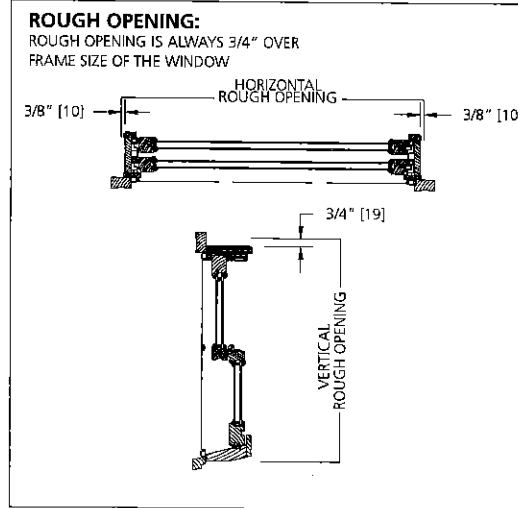

**FRAME TO TRIM
DIMENSIONS**

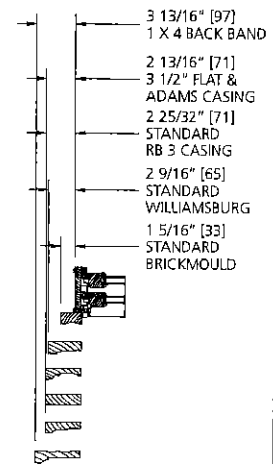

TYPICAL FOR HEAD, SIDE

**1-WIDE UNIT
DP50**

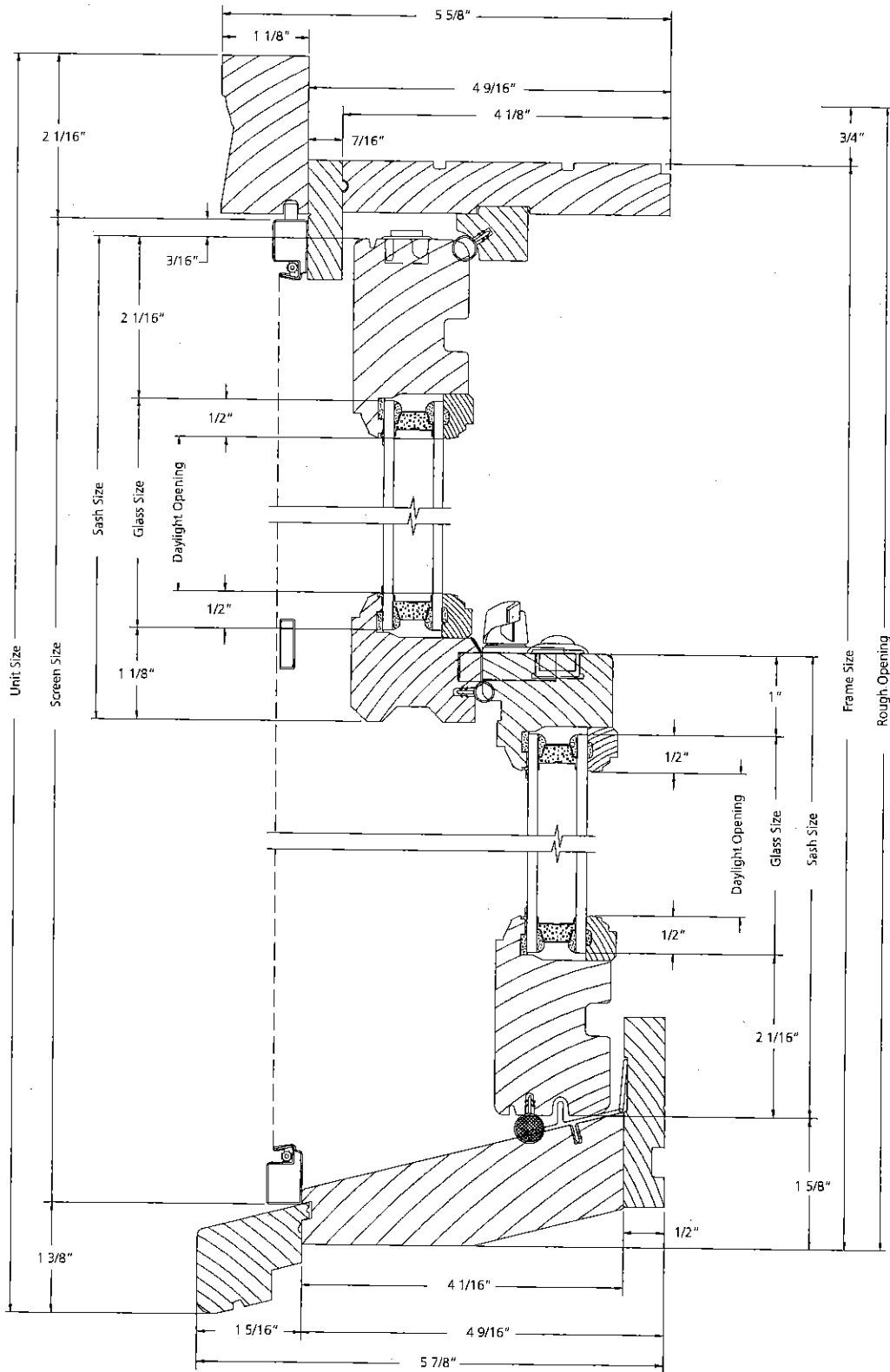

VERTICAL SECTION

SCALE: 6" = 1'

1-WIDE UNIT

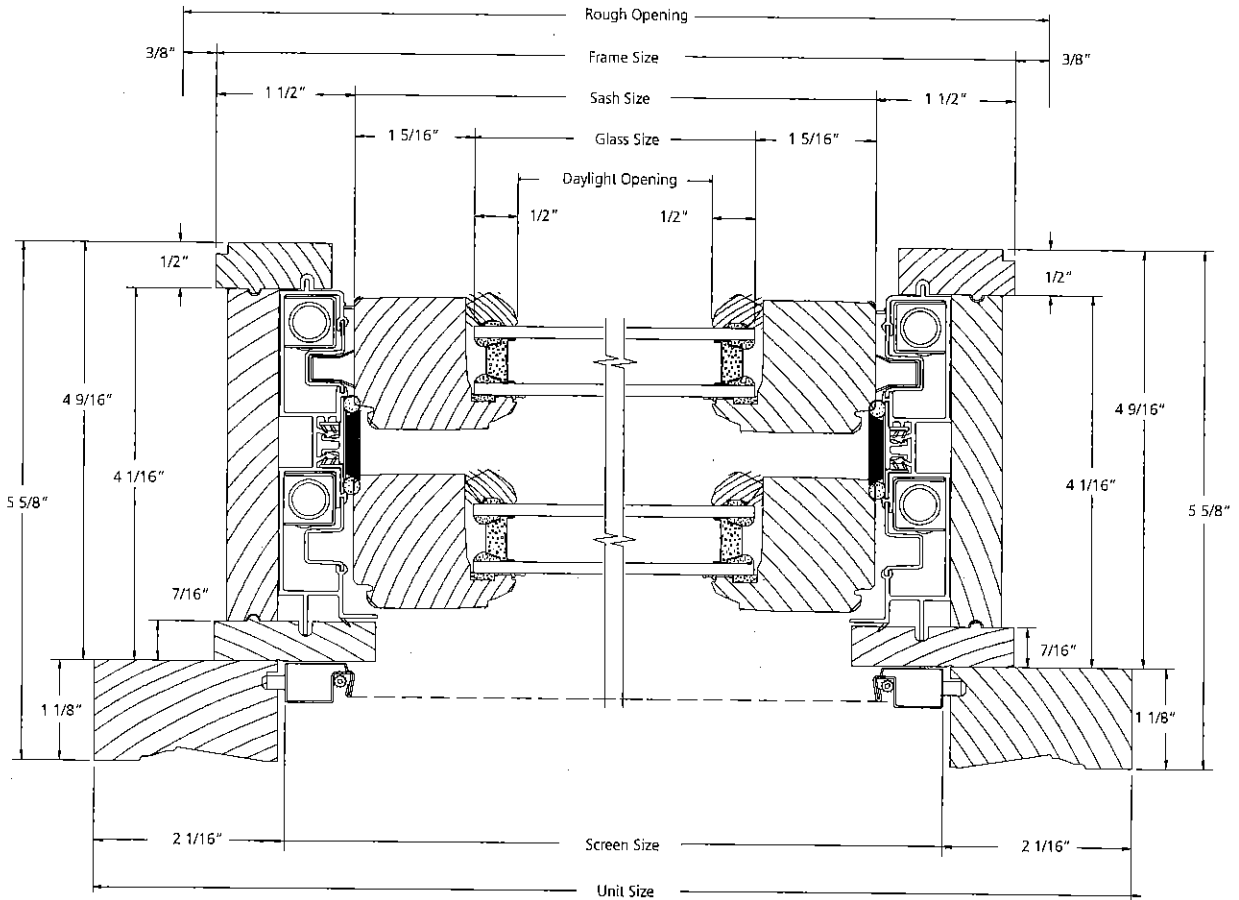

HORIZONTAL SECTION

SCALE: 6" = 1'

PICTURE UNIT
DP50

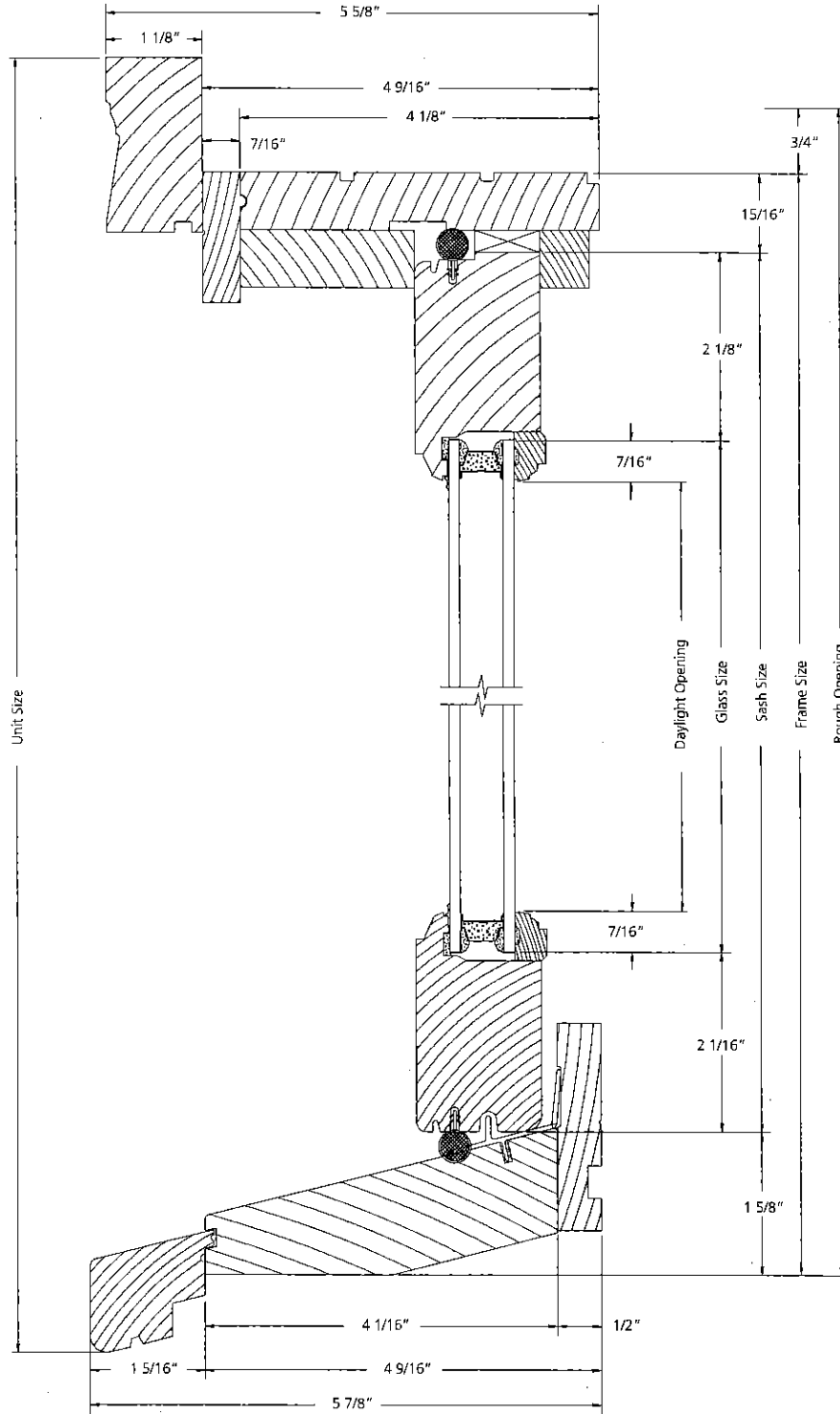

VERTICAL SECTION

SCALE: 6" = 1'

PICTURE UNIT

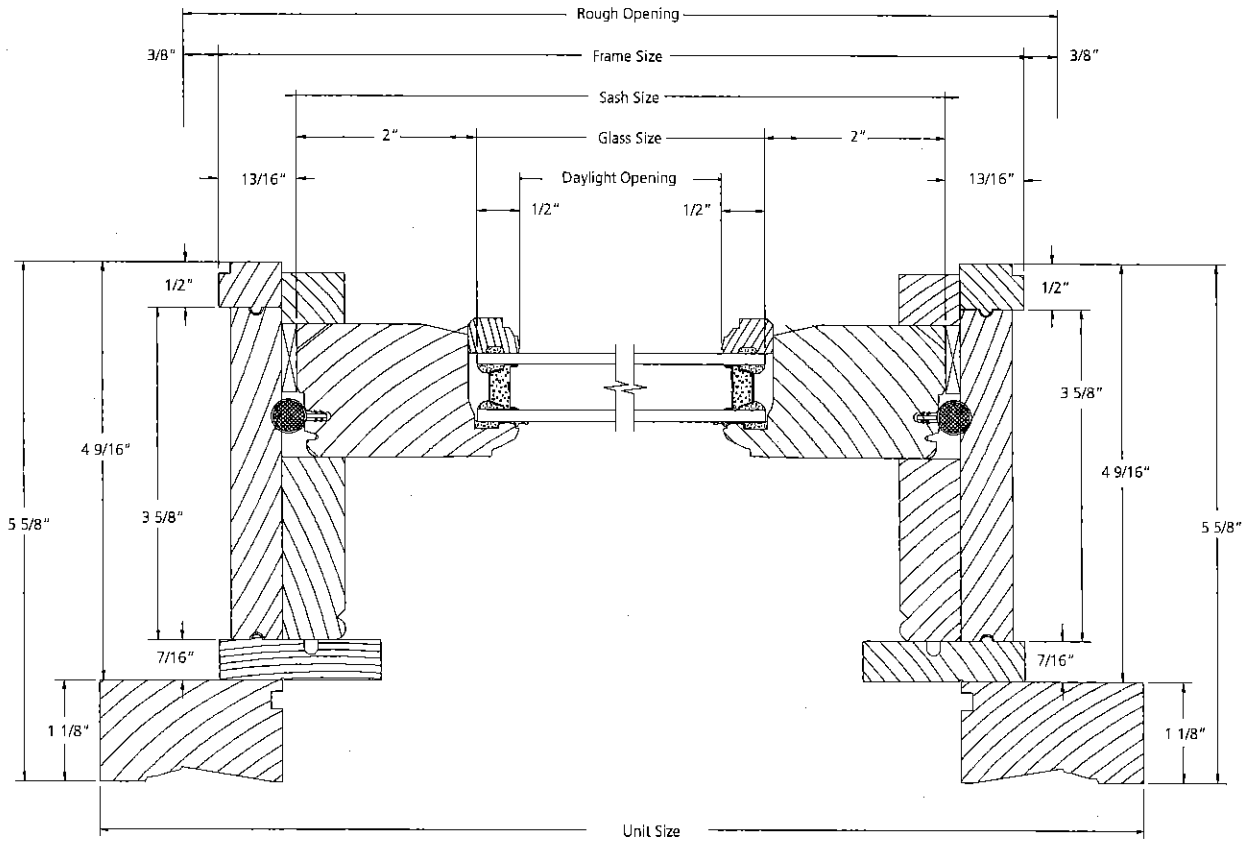

HORIZONTAL SECTION

SCALE: 6" = 1'

FULL RADIUS UNIT

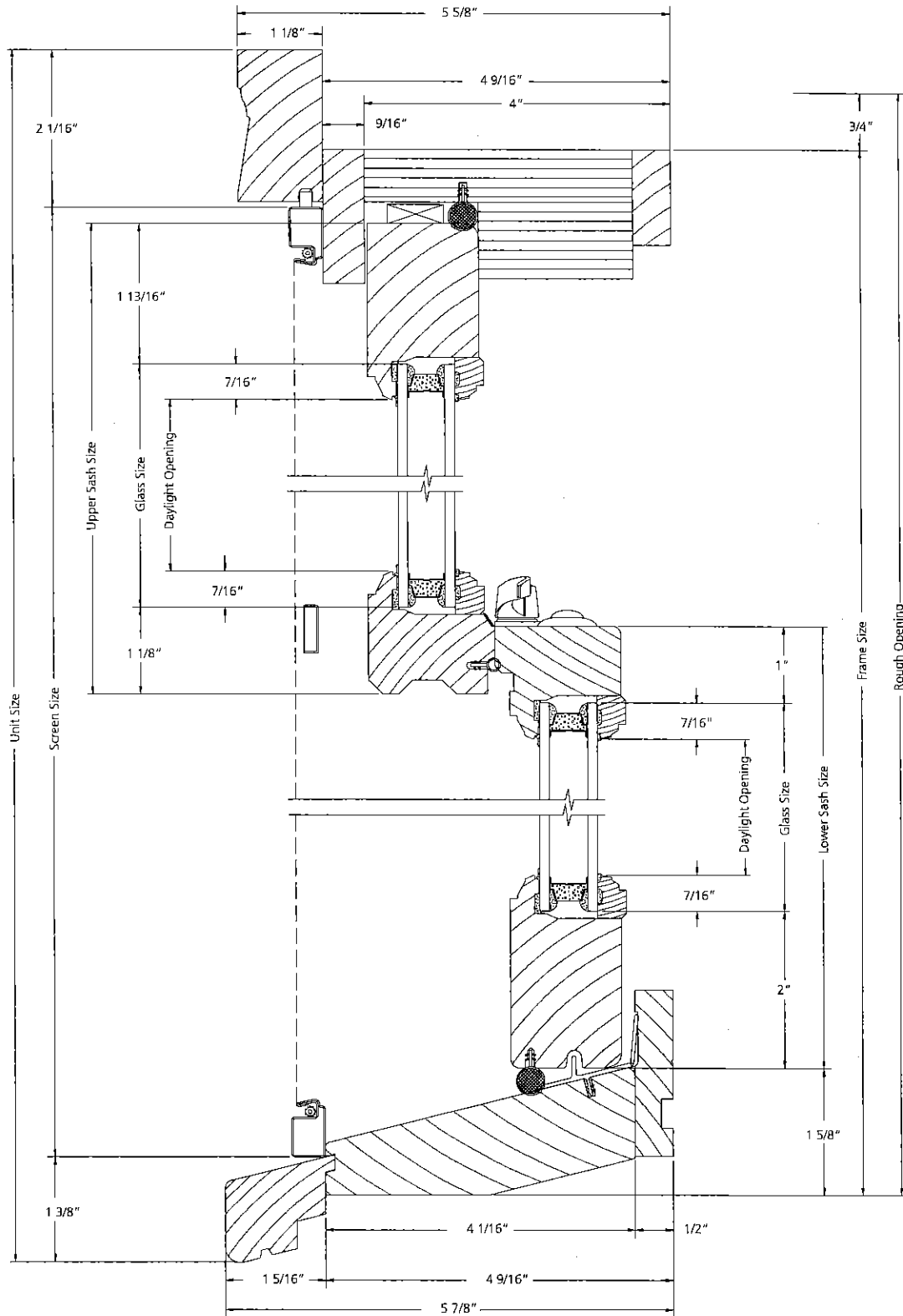

VERTICAL SECTION

SCALE: 6" = 1'

FULL RADIUS UNIT

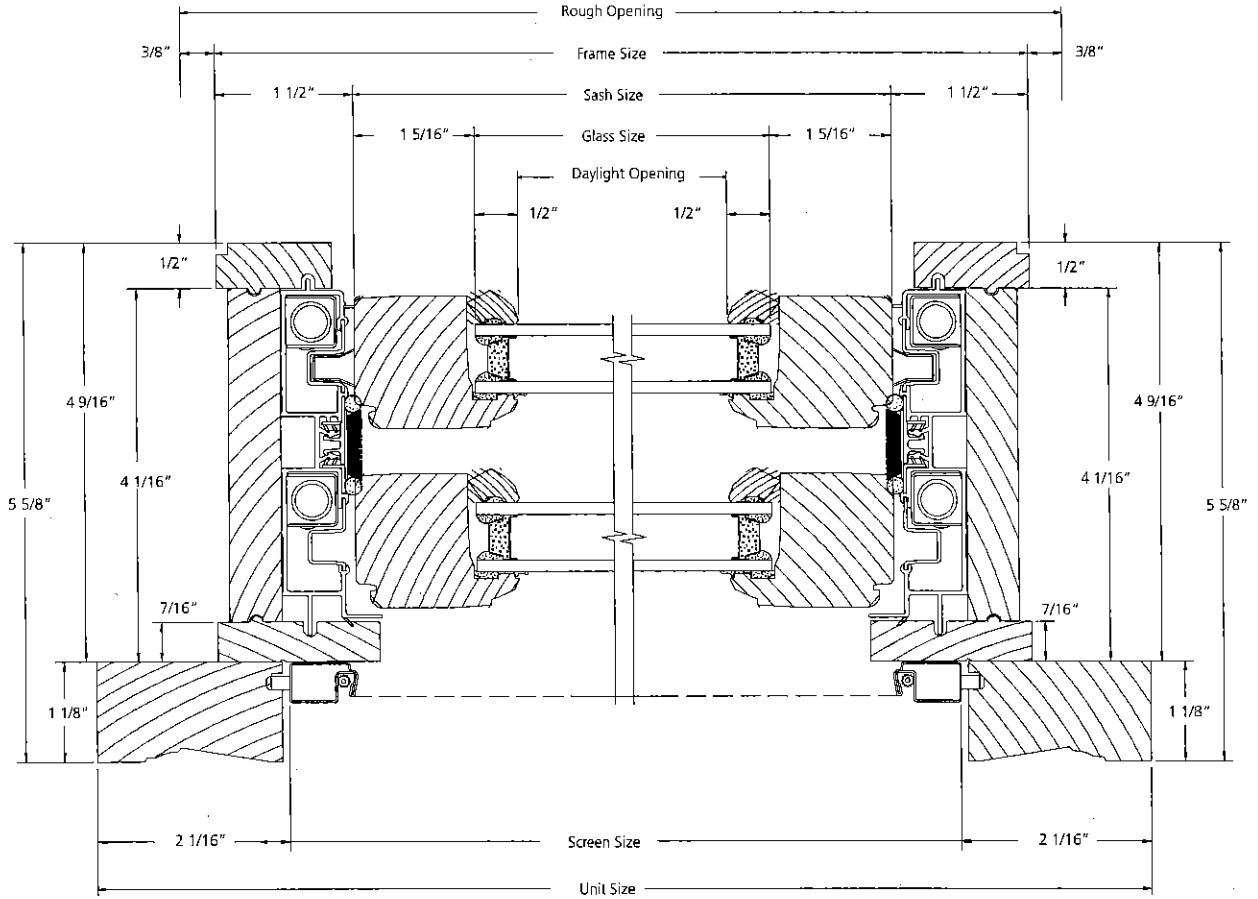

HORIZONTAL SECTION

SCALE: 6" = 1'