

1 BEDROOM UNIT NOS 201 & 301 (ADAPTABLE)

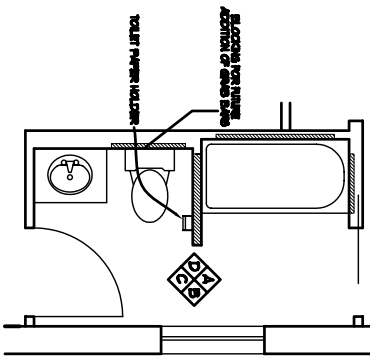

1 BEDROOM UNIT NOS 209 & 309 (ADAPTABLE)

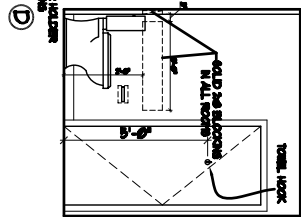
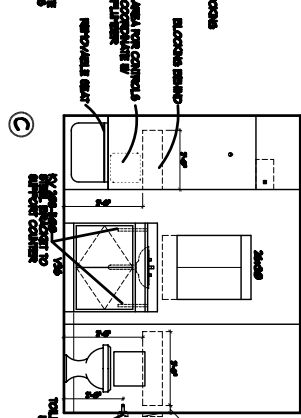
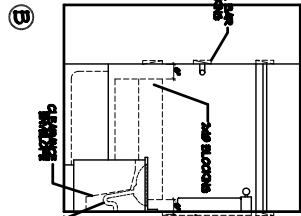
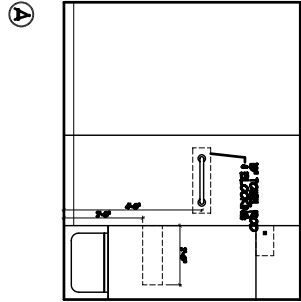
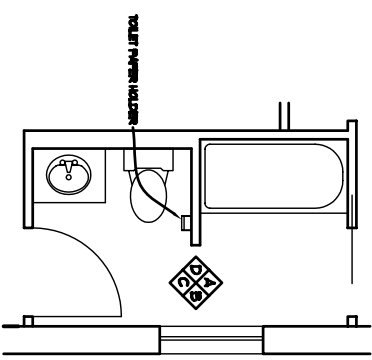
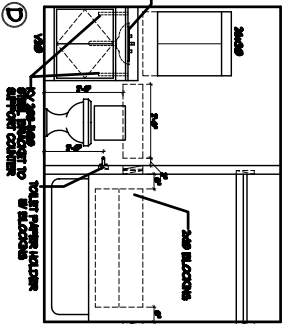
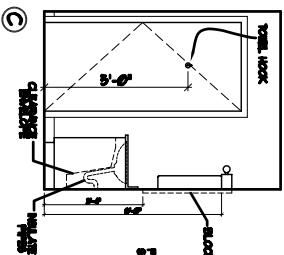
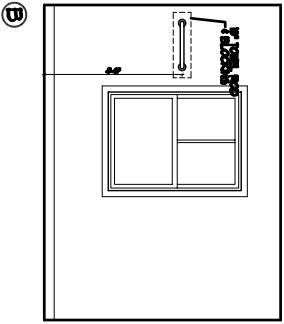
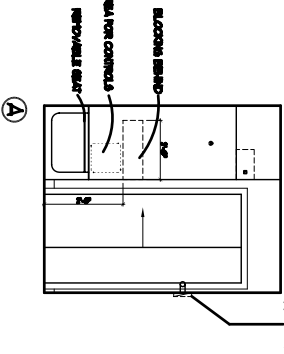

2 BEDROOM UNIT NOS 409

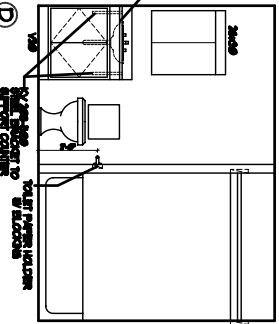
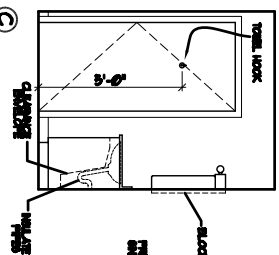
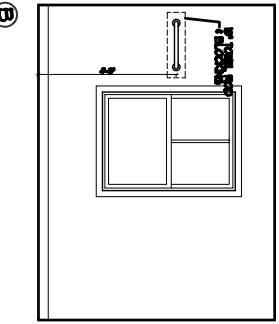
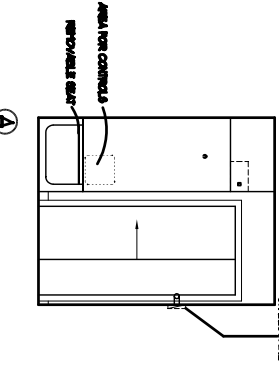

A219	ACCESSIBLE UNITS BATHROOM ELEVATIONS	May 28, 2003 1/2" = 1'-0" Revisions	Project: CASCO TERRACE 41 STATE STREET, PORTLAND, MAINE	ARCHETYPE, P.A. ARCHITECTS 48 Union Wharf Portland, Maine 04101 (207) 772-6022 Fax (207) 772-4056	Developer: MAINE WORKFORCE HOUSING, LLC
	<div style="display: flex; justify-content: space-between;"> 06/03/2003 10:53:54 AM Project: CASCO TERRACE ARCHETYPE, P.A. ARCHITECTS Developer: MAINE WORKFORCE HOUSING, LLC </div>				