

Submittal Data: 15RLS3H Inverter Driven Heat Pump **15,000 BTU Wall Mount**

Job Name: _____

Date: _____

Location: _____

Approval: _____

Engineer: _____

Construction: _____

Submitted to: _____

Unit #: _____

Submitted by: _____

Drawing #: _____

Reference: _____

General Features

- Wired or wireless remote
- Energy saving program
- Sleep timer
- 24-hour timer
- Weekly timer
- Dry mode
- Powerful mode
- High performance heating
- Base pan heater
- Standard Warranty: 5 years parts, 7 years compressor. Applies to systems purchased before June 1st 2015*
- Extended Warranty: 10 years parts, 10 years compressor. Systems that have been installed on or after June 1st 2015 by licensed contractors and the online Product Registration has been submitted.**
- Elite Contractor Extended Warranty: 12 years parts, 12 years compressor. Systems that have been installed on or after June 1st 2015 by contractors who have met requirements and have been approved for elite contractor status plus, the online Product Registration has been submitted. ***

Model Information

Condenser..... AOU15RLS3H
Evaporator..... ASU15RLS3

Electrical..... 208/230V AC 1ph-60Hz
Available Voltage Range..... 208/230 +/- 10%
Minimum Circuit Ampacity..... 18.2 A
Max Fuse Size..... 20A
Max Starting Current..... 5.2 A

Input Power

Cooling..... 1.04 kW
Heating..... 1.15 kW

Running Current

Cooling..... 4.8 A
Heating..... 5.2 A

Capacity

Nominal Cooling..... 15,000 Btu
Min-Max Cooling..... 3,100-18,400 Btu/h
Nominal Heating..... 18,000 Btu/h
Min-Max Heating..... 3,100-23,900 Btu/h

Compressor

..... Rotary (inv x1)
Motor Output..... 1,000 W
Refrigerant..... R410a
Charge..... 3 lbs. 1 oz
Oil..... FREOL a68SZ

Fan Motor

(Condenser) Type: DC Propeller x 1
(Condenser) Motor Output..... 49 W
(Evaporator) Type: DC..... Cross flow fan x 1
(Evaporator) Motor Output..... 61 W

Heat Exchanger (Condenser (C) Evaporator (E))

Dimensions (H x W x D)
Condenser..... 23-1/8 x 34-11/16 x 1-7/16 in. (588x881x36.4 mm)
Evaporator..... Main 15-1/8 x 28-3/8 x 1-3/16 in. (384x720x30) Sub 3-5/16 x 28-3/8 x 1/2 in. (84x720x13.3 mm) 4-15/16 x 28-3/8 x 1/2 in. (126x720x13.3 mm)
Fin Pitch..... 20 FPI (C) Main 21 FPI Sub 18 FPI (E)
Rows x Stages..... 2 x 28 (C) Main 3 x 24 Sub 1 x 10 (E)
Pipe Type (Material)..... Copper (C) Copper (E)
Fin Type (Material)..... Aluminum (C) Aluminum (E)

Note: Specifications are based on the following conditions:
Cooling: Indoor temperature of 80°F (26.7°C) DB/67°F (19.4°C) WB, and outdoor temperature of 95°F (35°C) DB/75°F (23.9°C) WB.
Heating: Indoor temperature of 70°F (21.1°C) DB/59°F (15°C) WB, and outdoor temperature of 47°F (8.3°C) DB/43°F (6.1°C) WB.
Pipe length: 248.7m (7.5m). Height difference: 9ft (3m) (Outdoor unit—indoor unit) (*Standard warranty**10 year warranty***12 year warranty)

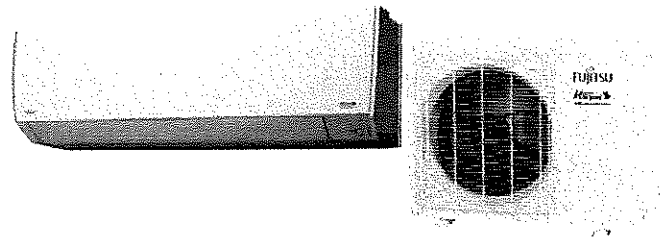

Operation Temperature Range

Cooling..... 14°F (-10°C) to 115°F (46°C)
Heating..... -15°F (-26°C) to 75°F (24°C)

Efficiency

SEER..... 25.3
EER (cooling)..... 4.09 kW/kW
COP (heating)..... 4.59 kW/kW
HSPF (heating)..... 13.3 Btu/hW

Enclosure (Condenser)

Material..... Painted galvanized steel
Color..... Beige (10 YR 7.5/1.0 NN)

Sound Pressure Level

Condenser..... 49 dB(A)
Evaporator..... 45 dB(A)

Dimensions

H x W x D
Condenser in. (mm)..... 24-1/2 (620) x 31-1/8 (790) x 11-7/16 (290)
Evaporator in. (mm)..... 11- 5/8 (295) x 37 (940) x 10-5/8 (270)

Connection Pipe

Liquid..... 1/4" / 6.35 mm Flare
Gas..... 1/2" / 12.7 mm Flare
Method (Liquid/Gas)..... Brazing
Max Length (Pre-charge)..... 66 ft. (20 m) / (49 ft. {15 m})
Max Height Difference..... 49 ft. (15 m)

Weight

Condenser..... 88 lbs. (40 kg)
Evaporator..... 31 lbs. (14 kg)

Accessories

UTY-RVNUM^..... Wired remote controller (backlit, shows room temp.)
UTY-RNNUM^..... Wired remote controller
UTY-RSNUM^..... Wired remote controller (simple)
UTY-TWBXF1..... Interface kit
UTY-XWZXZ5..... Dry contact wire kit

Interftek®ETL Number

AOU15RLS3H..... 91986
ASU15RLS3..... 91986

* Requires interface kit# UTY-TWBXF1 in order to connect these devices to them.



Dimensions: 15RLS3H

[Unit: in. (mm)]

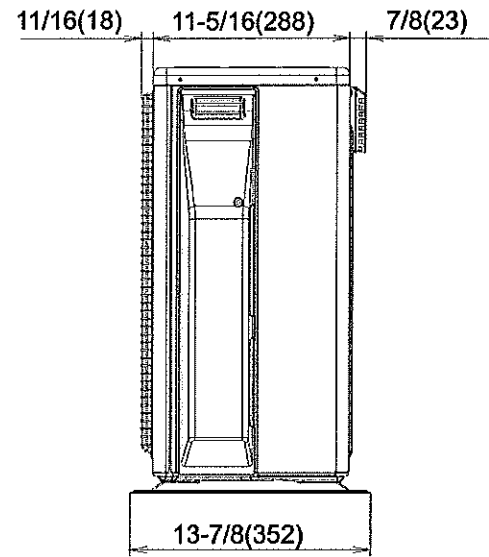
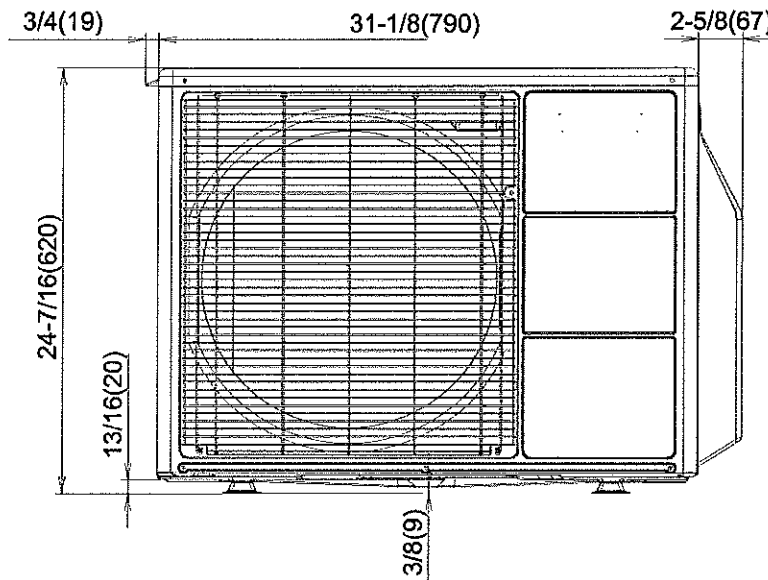
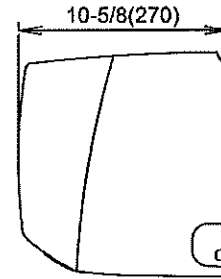
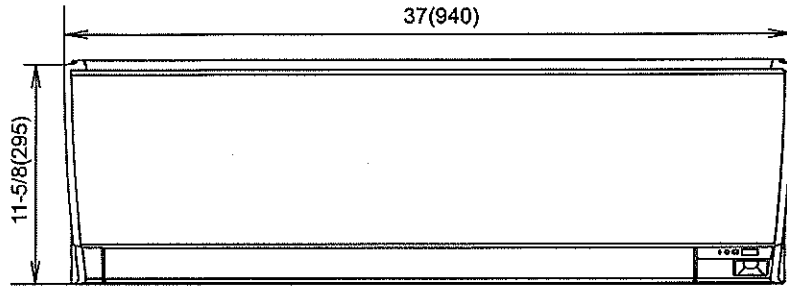

Front view

Side view

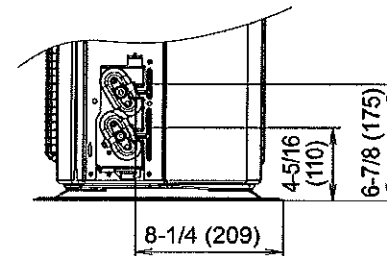
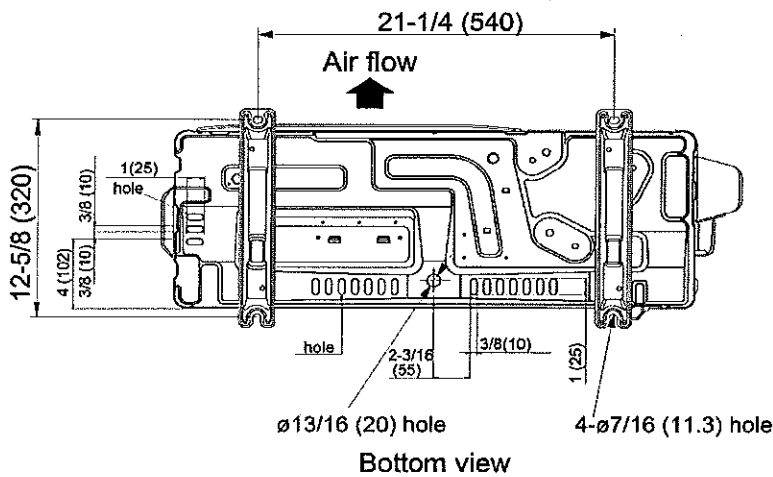

Bottom view