

CHAIN LINK FENCE INSTALLATION SCHEDULE

FENCE HEIGHT	GATE POST PIPE DIA.	LINE POST PIPE DIA.	CORNER & TERMINAL POST PIPE DIA.
(A) 4'	3.0" O.D.	1.90"	2.975"
(B) 5'	4.0" O.D.	2.375"	2.875"

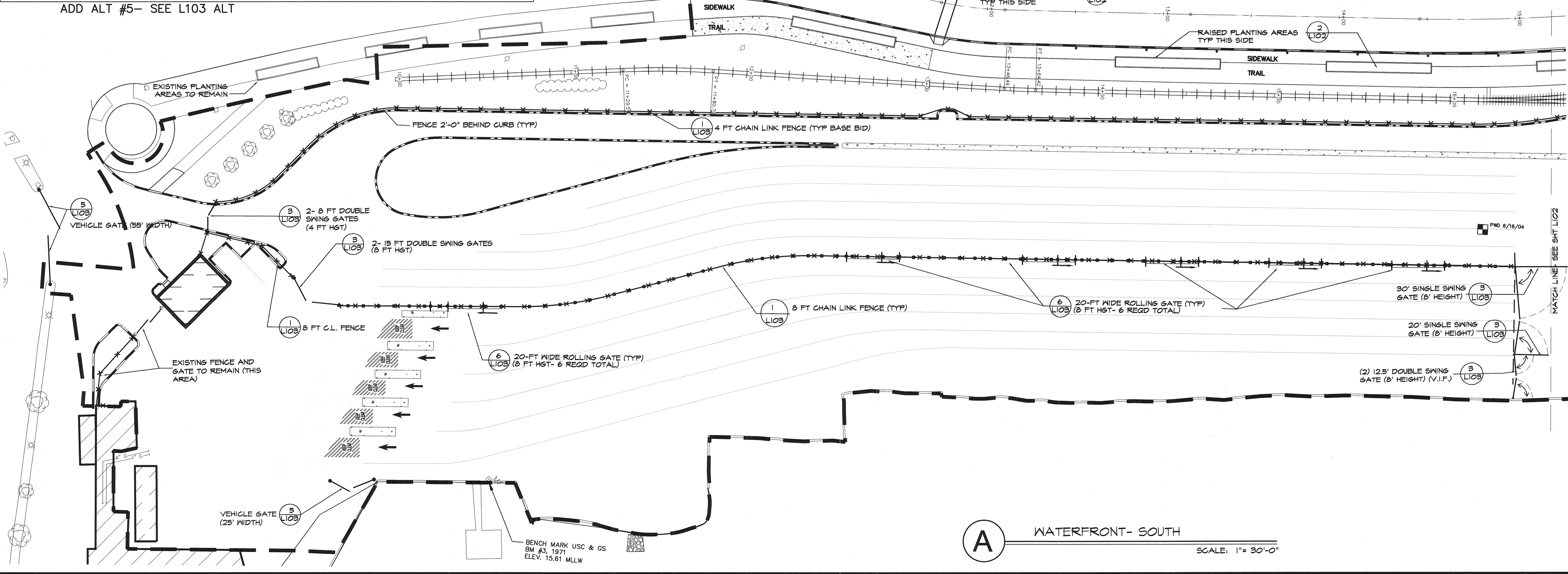
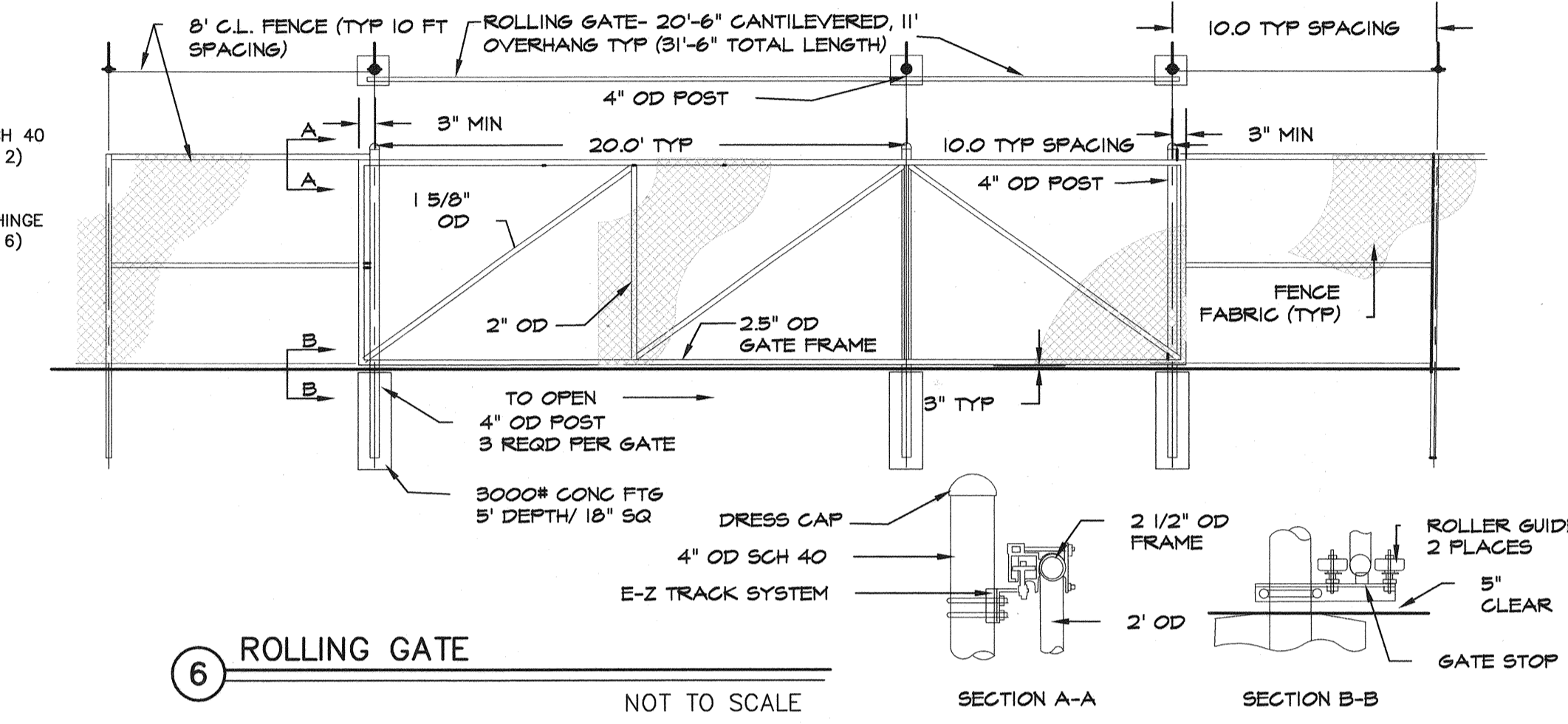
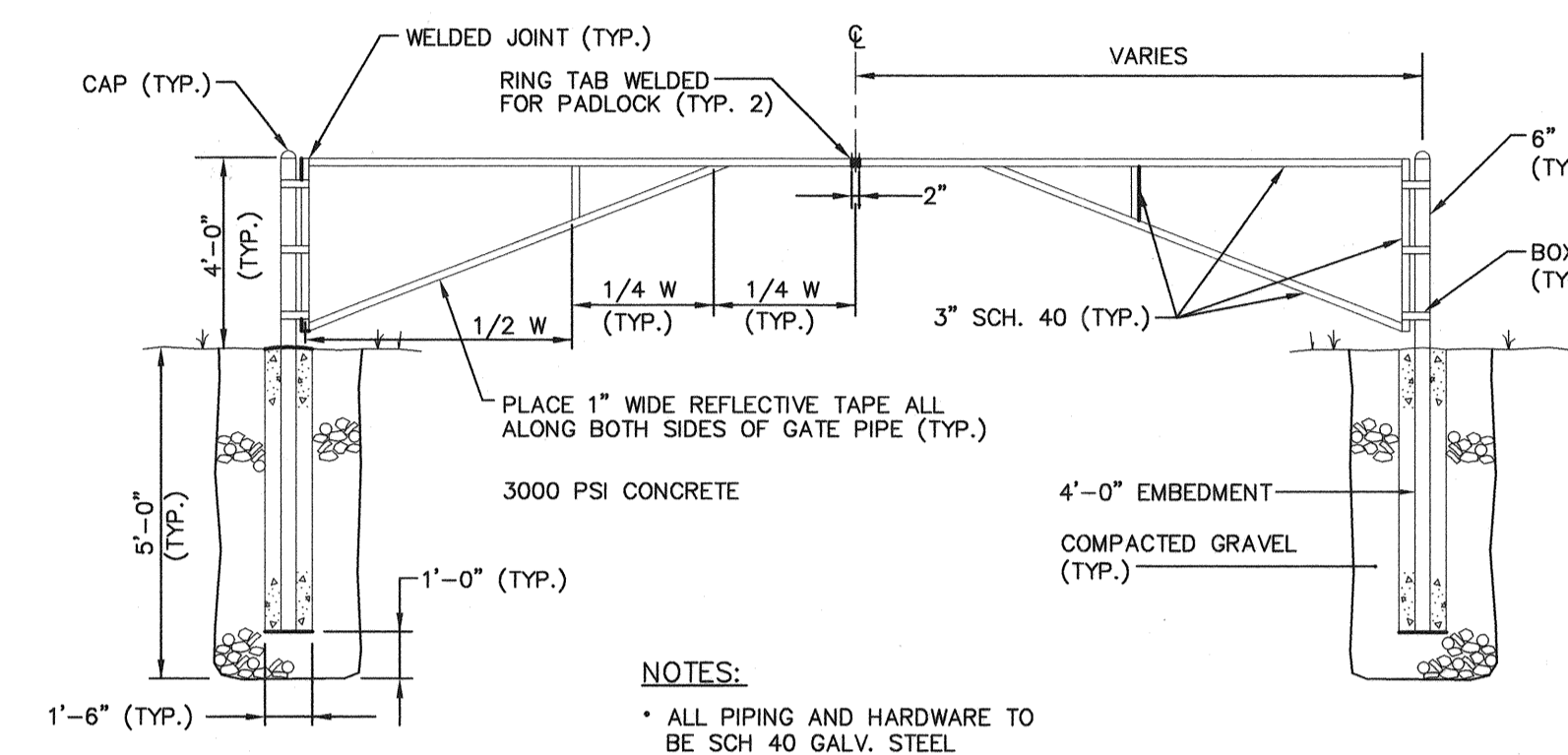
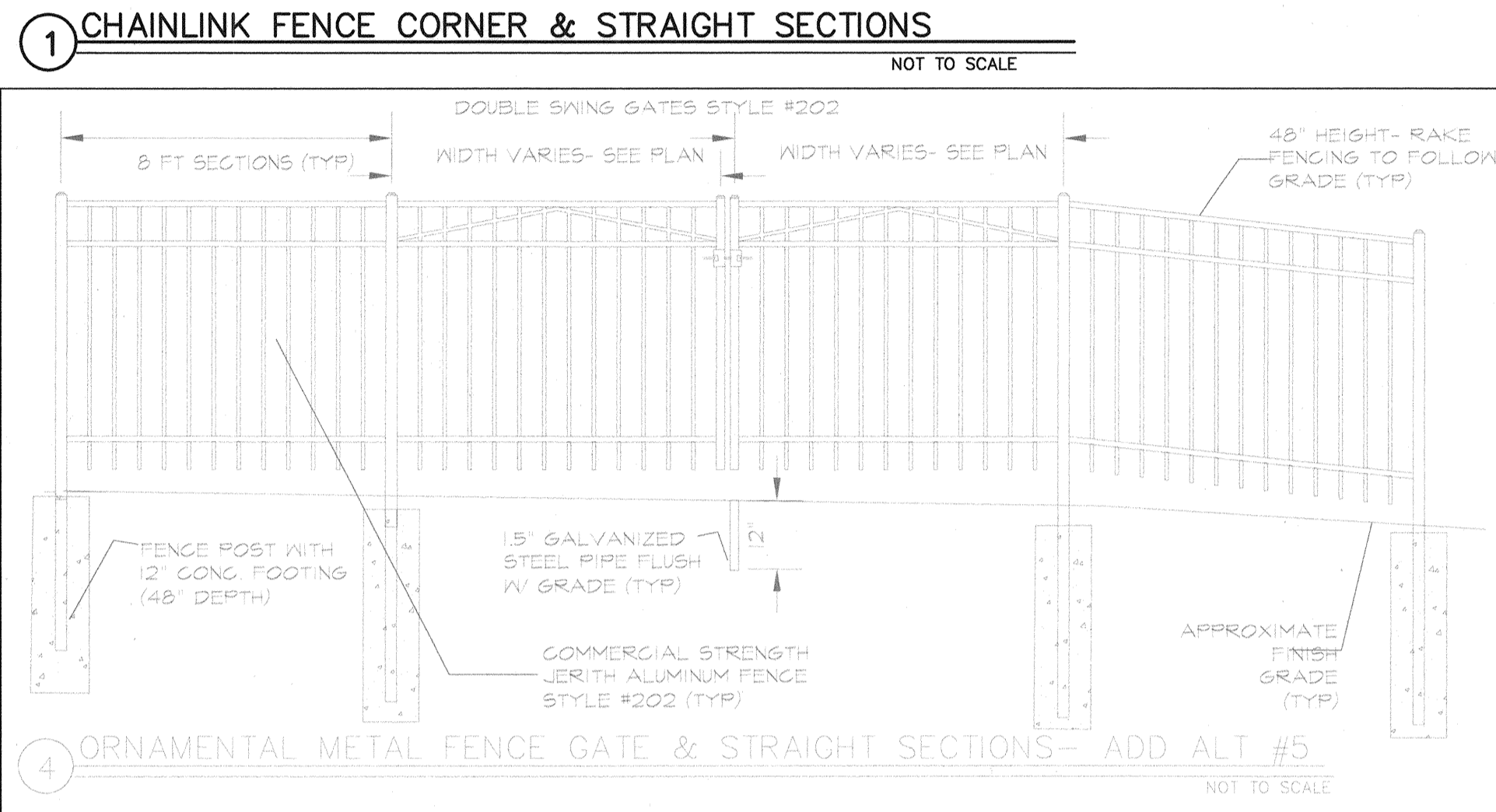
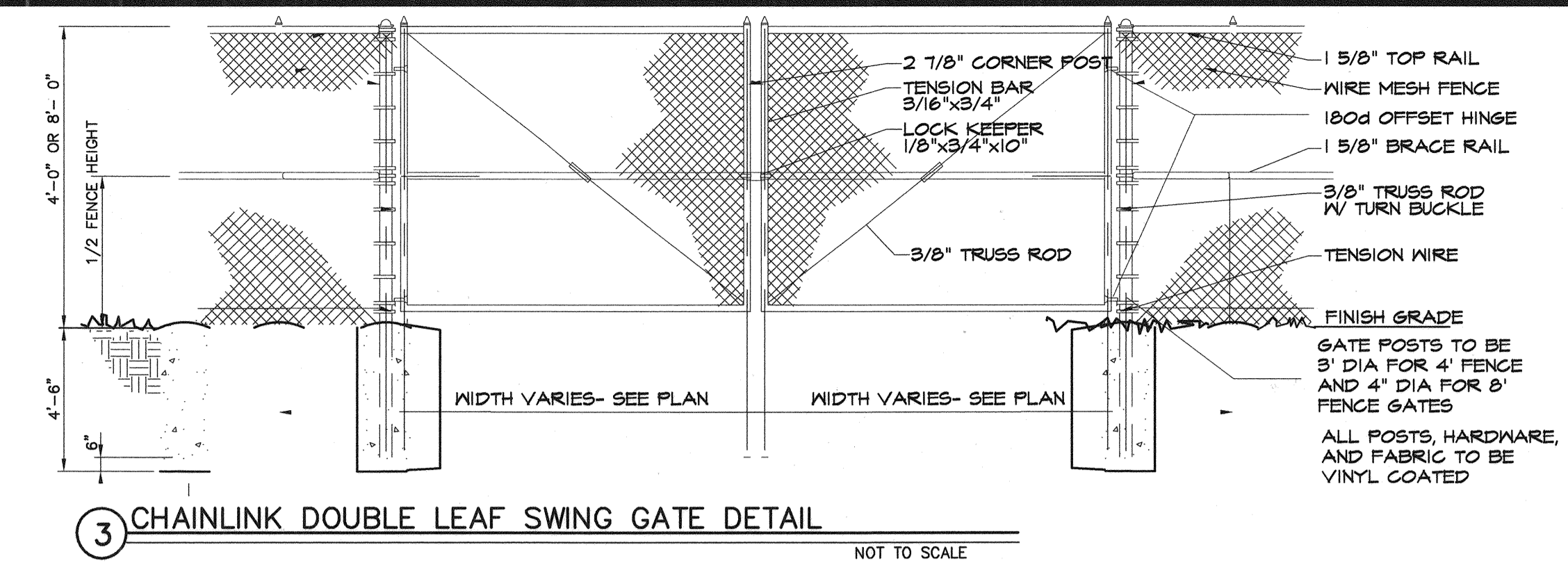
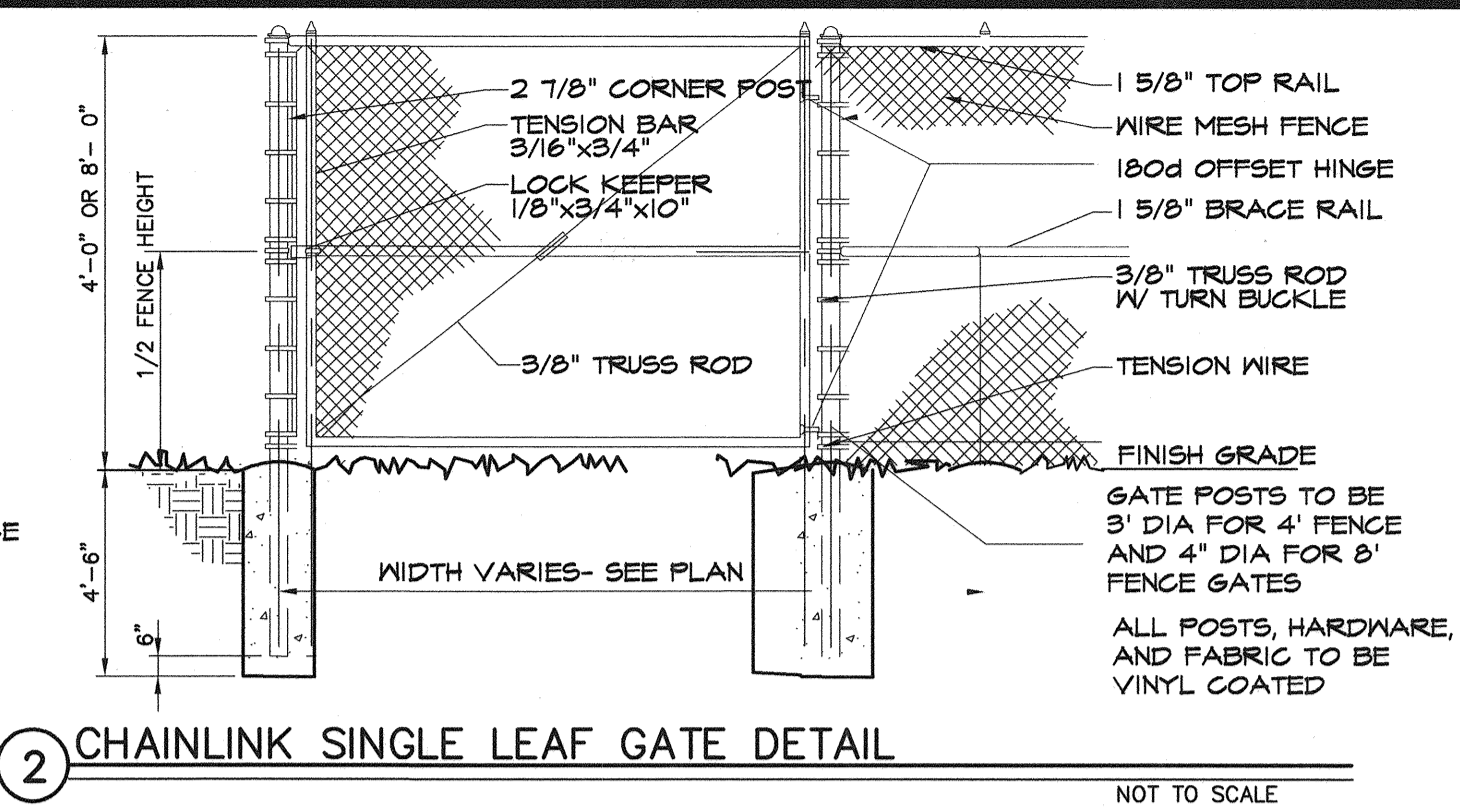

CARROLL ASSOCIATES
 75 MARKET STREET PORTLAND, ME 04101
 207.772.1855 carroll@maine.com
 Landscape Architects

STATE OF MAINE
 DEPARTMENT OF TRANSPORTATION
 PROJECT NUMBER 009215.00
 PIN 009215.00

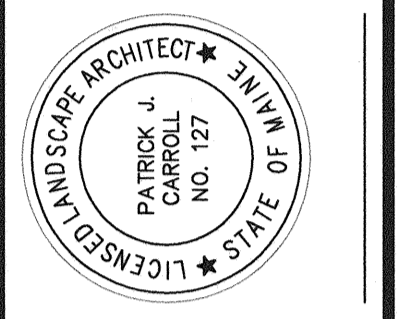

DATE: 10/27/04
 BY: PC
 CHECKED-REVIEWED: 10/27/04
 DESIGNED-DETAILED2: PATRICK J. CARROLL
 DESIGNED-DETAILED3: PATRICK J. CARROLL
 REVISIONS: 1
 REVISIONS: 2
 REVISIONS: 3
 REVISIONS: 4
 FIELD CHANGES

PROJ. MANAGER: PAUL POTTE
 DESIGN-DETAILED: PAUL POTTE
 CHECKED-REVIEWED: PAUL POTTE
 DESIGNED-DETAILED2: PAUL POTTE
 DESIGNED-DETAILED3: PAUL POTTE
 REVISIONS: 1
 REVISIONS: 2
 REVISIONS: 3
 REVISIONS: 4
 FIELD CHANGES

CITY OF PORTLAND
 OCEAN GATEWAY PHASE 1
 SITE IMPROVEMENTS PLAN
 SOUTH-WEST

L103
 SHEET 54 of 288

Filename: