

FINISHER

MAIN

STARTER

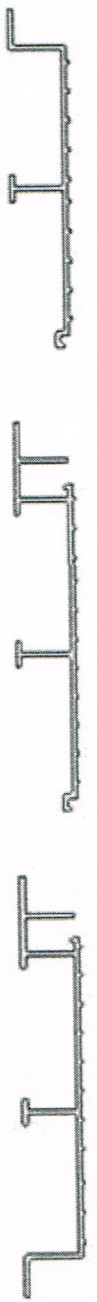

#10 X 3/4" PANTORX

TRIM INSTALLS WITH OFFSET NIB LEG DOWN PROVIDING A DRIP EDGE AND DRAINAGE.

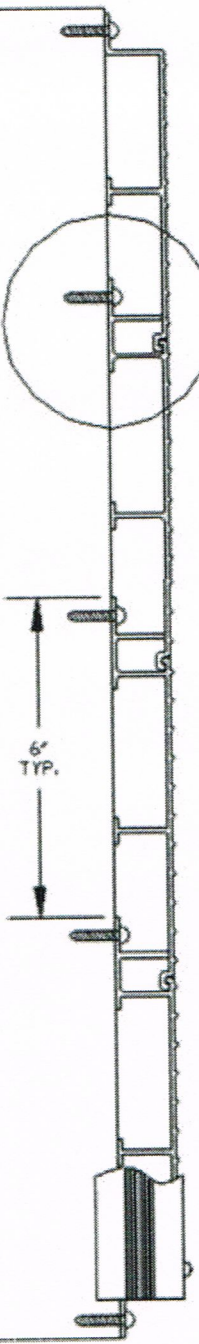

JOIST

RECOMMENDED 2" MINIMUM OVERHANG

FASCIA

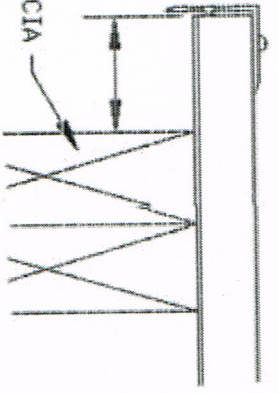

STARTER AND FINISHER STEP TREAD INSTALLATION FOR STEP TREAD RUNS LESS THAN 12"

NOTCH DECKING AROUND STRINGER, BLOCK UP INSIDE OF STRINGER TO SUPPORT AND FASTEN STEP TREAD TO. EDGE TRIM CAN BE USED TO FINISH OFF ALL SIDES OF DECKING.

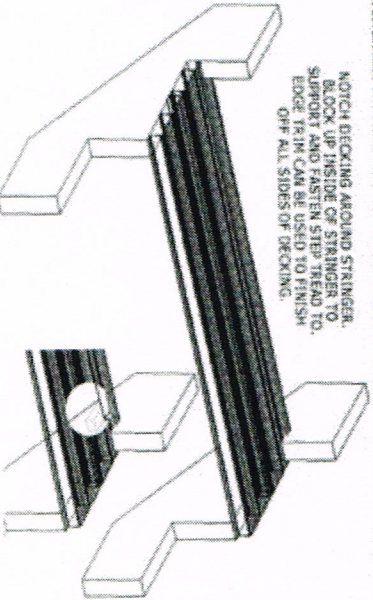

DRILL A 13/64" PILOT HOLE THROUGH ALUMINUM ONLY

#10 X 1 1/2" S.S. WOOD SCREW

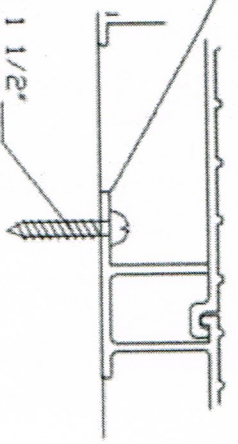

VIEW IN CIRCLE 'A'

1 1/2" X 1 1/2" EDGE TRIM USED TO COVER THE OPEN END OF THE FLOORING.

NOTE: 1/8" DROP PER FOOT AWAY FROM THE STRUCTURE IS REQUIRED

NOTE: TO AVOID WATER POOLING ON DECK SURFACE, RAFTERS AND/OR JOIST MUST REMAIN FLAT TO WITHIN 1/4"

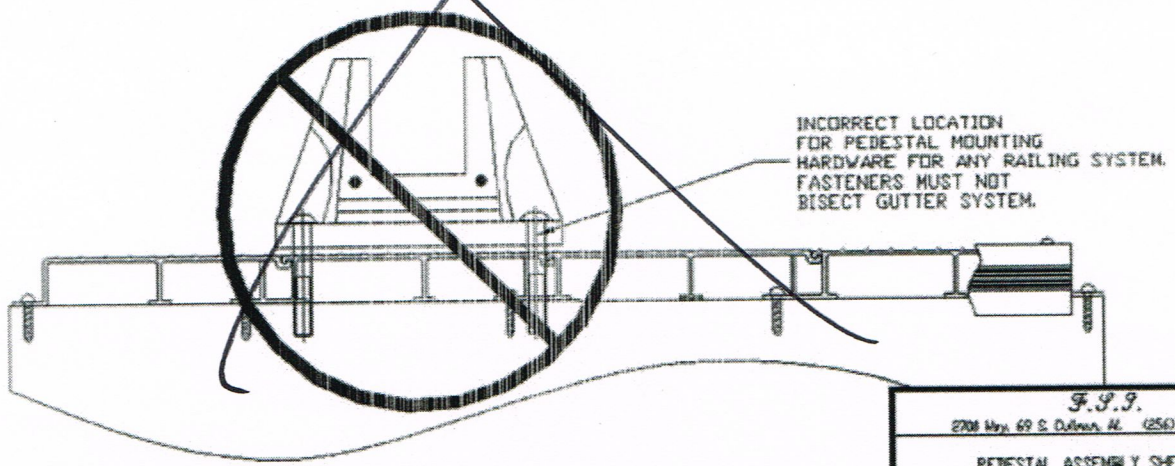
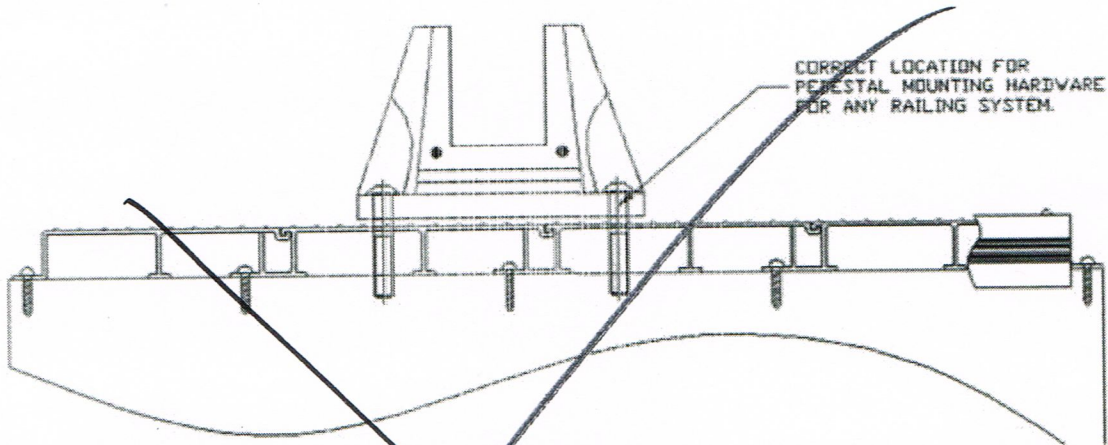

F.P.P.
 2701 Hwy. 69 S. Dulles, Va. (254) 287-8417
 PEDESTAL ASSEMBLY SHEET 6

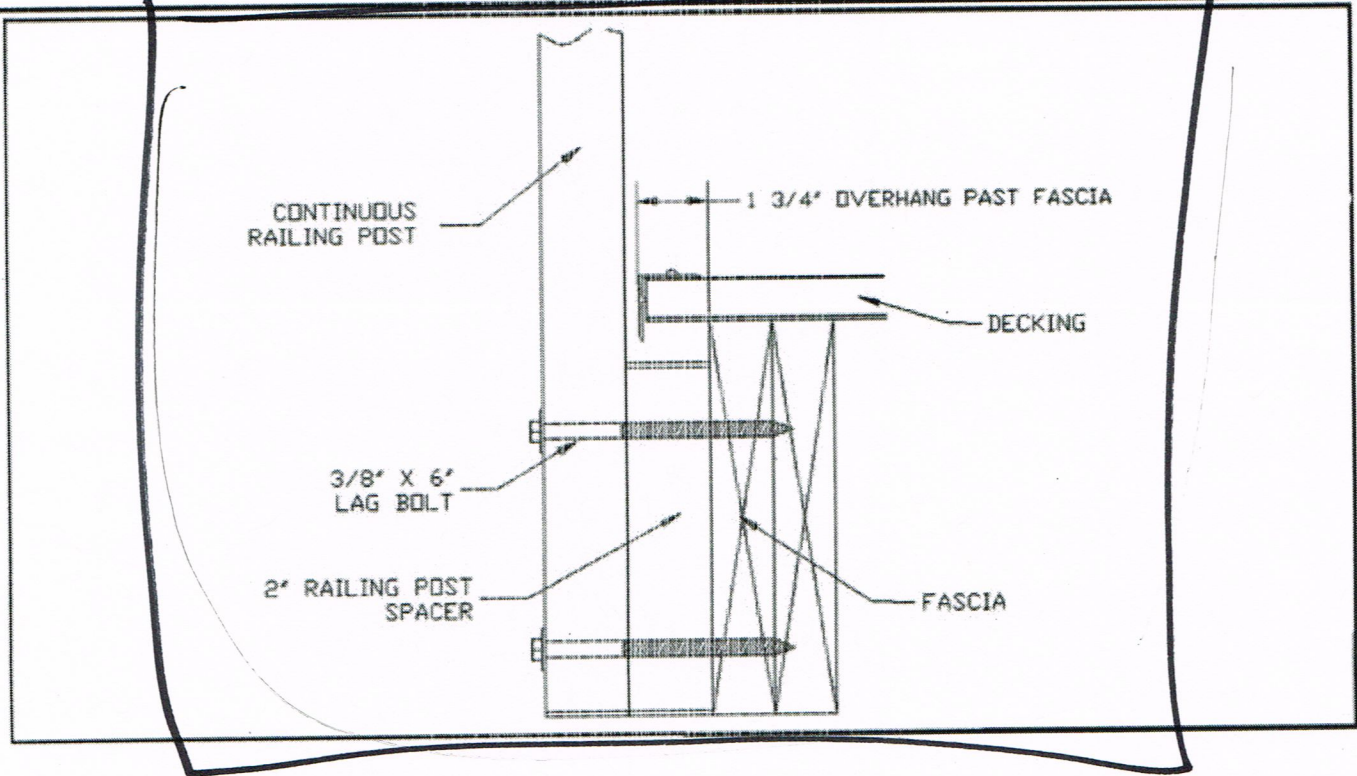

Cable Railing Assembly Details

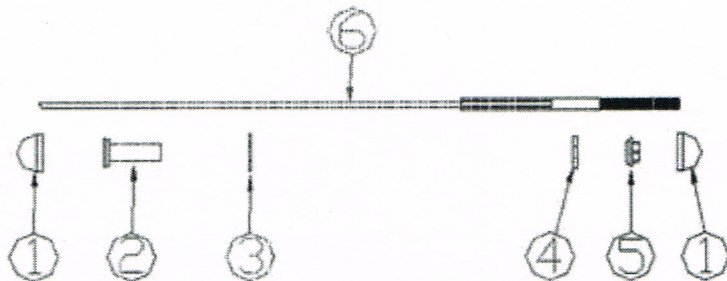
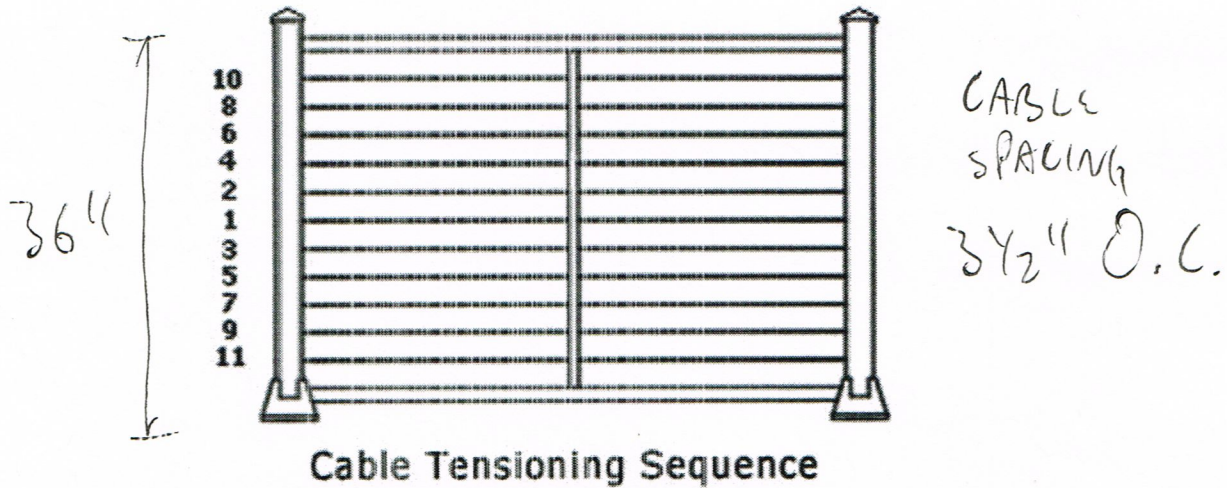

1:	COLORED END CAP
2:	S.S. QUICK CONNECT FITTING
3:	3/4" NYLON WASHER
4:	3/4" NYLON WASHER
5:	1/4" S.S. WASHER NUT
6:	1/8" S.S. CABLE ASSEMBLY

