

7 NEW EXTERIOR OFFICE FRONTS - (FULL VIEW) ELEVATION
1/2" = 1'-0"

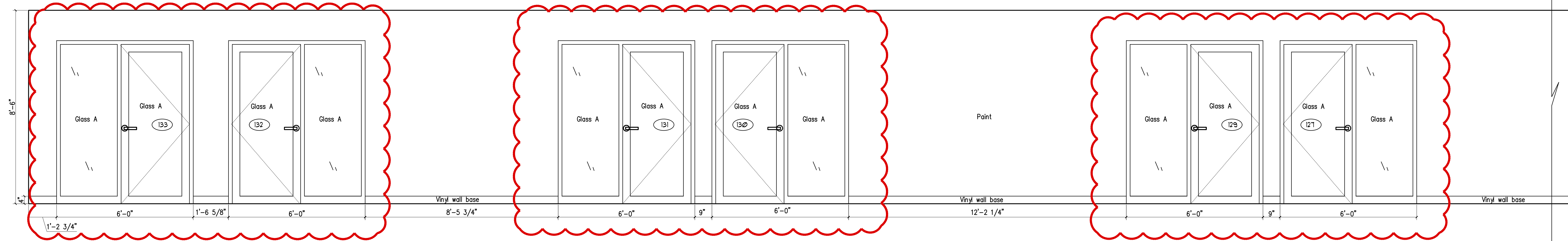

7A NEW EXTERIOR OFFICE FRONTS - (PARTIAL) ELEVATION
1/2" = 1'-0"

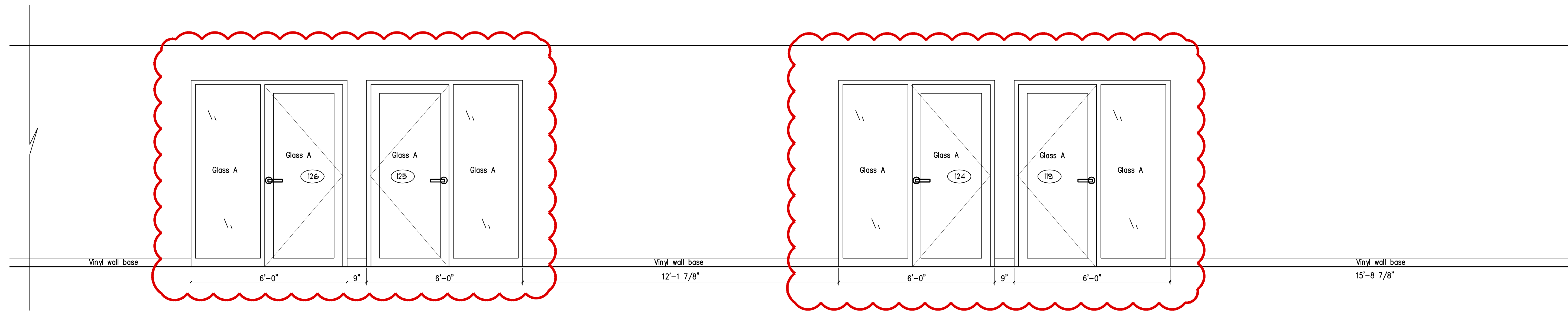

7B NEW EXTERIOR OFFICE FRONTS - (PARTIAL) ELEVATION
1/2" = 1'-0"

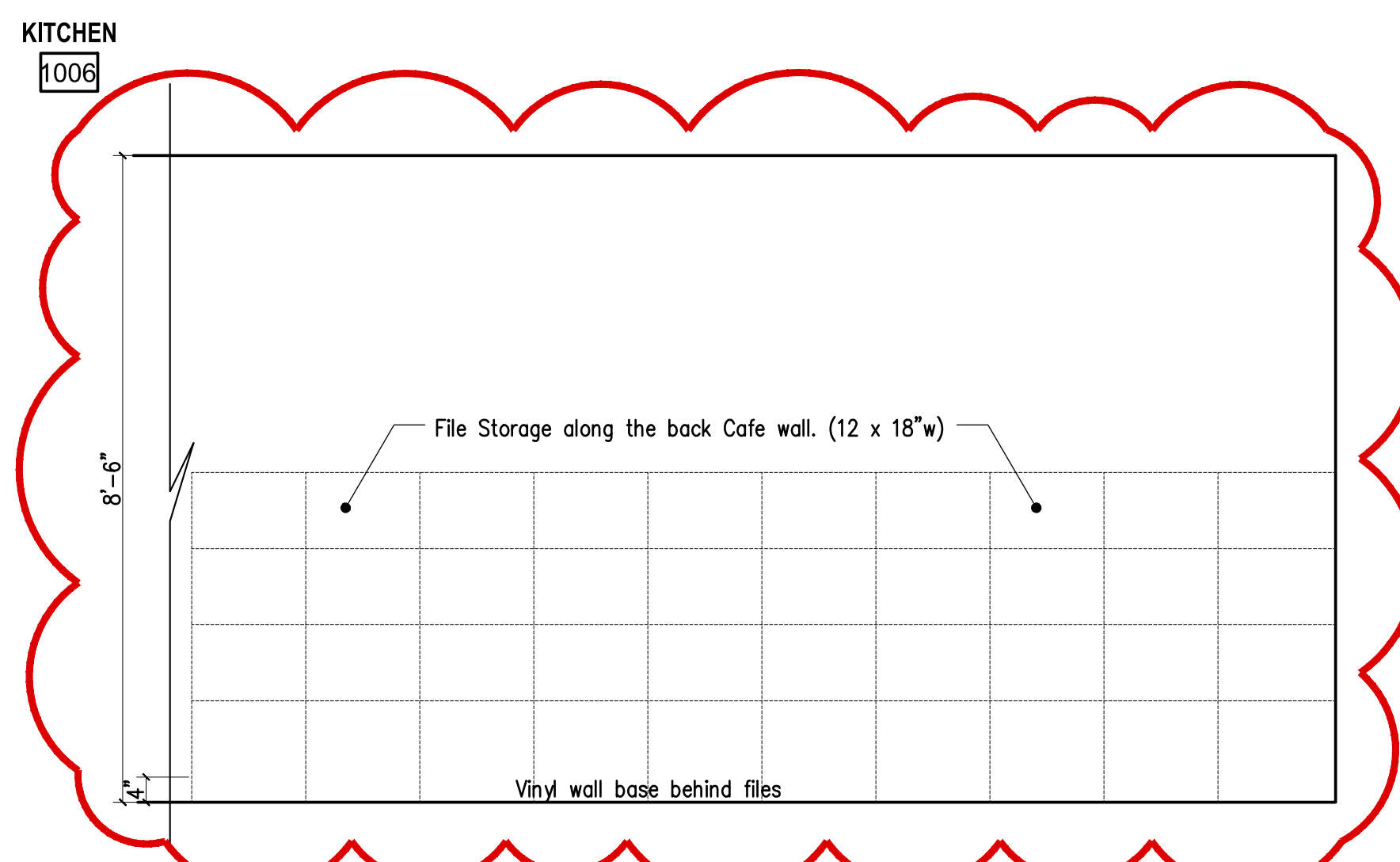

8 CAFE 143 - ELEVATION
1/2" = 1'-0"

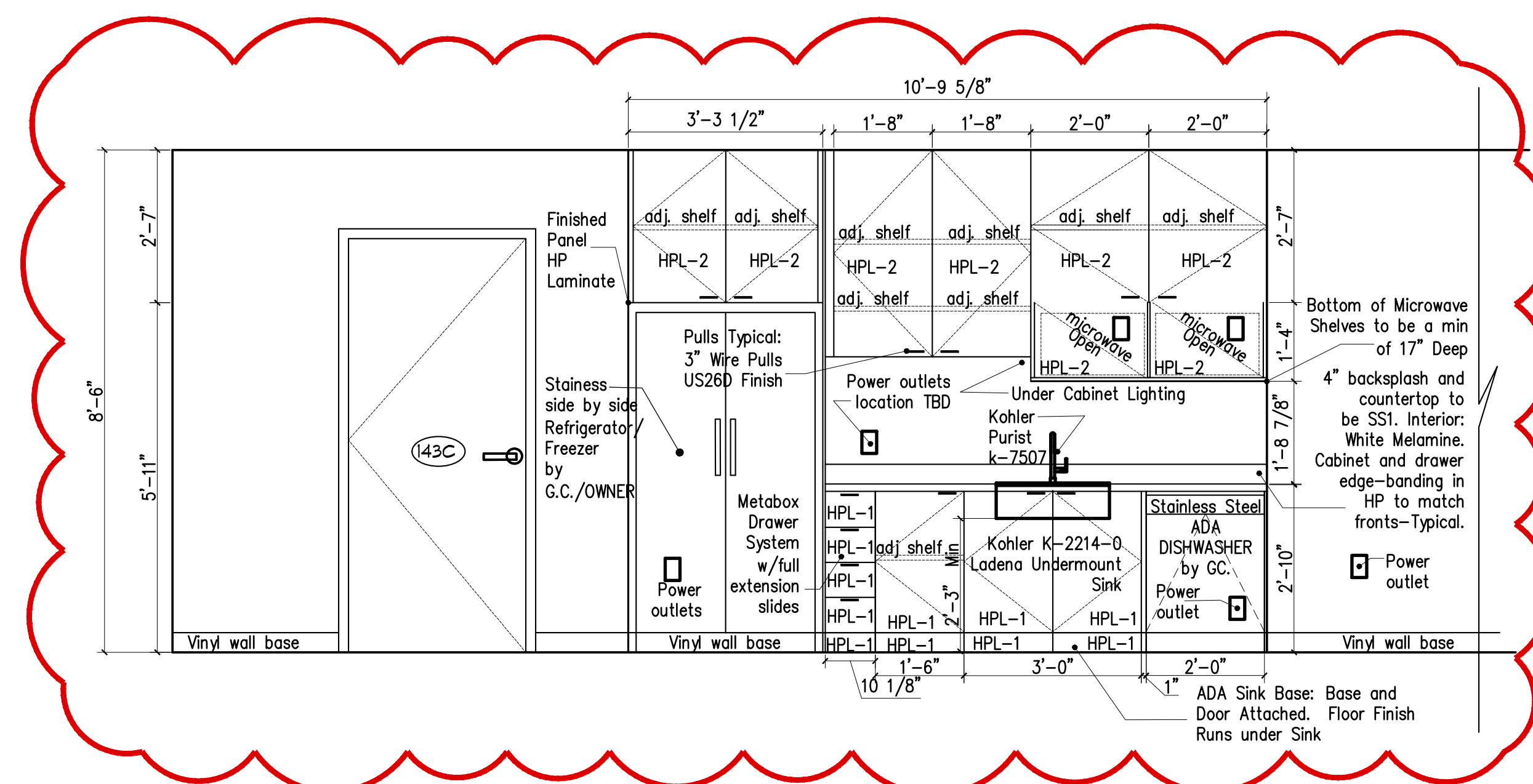

9 CAFE 143 - ELEVATION
1/2" = 1'-0"

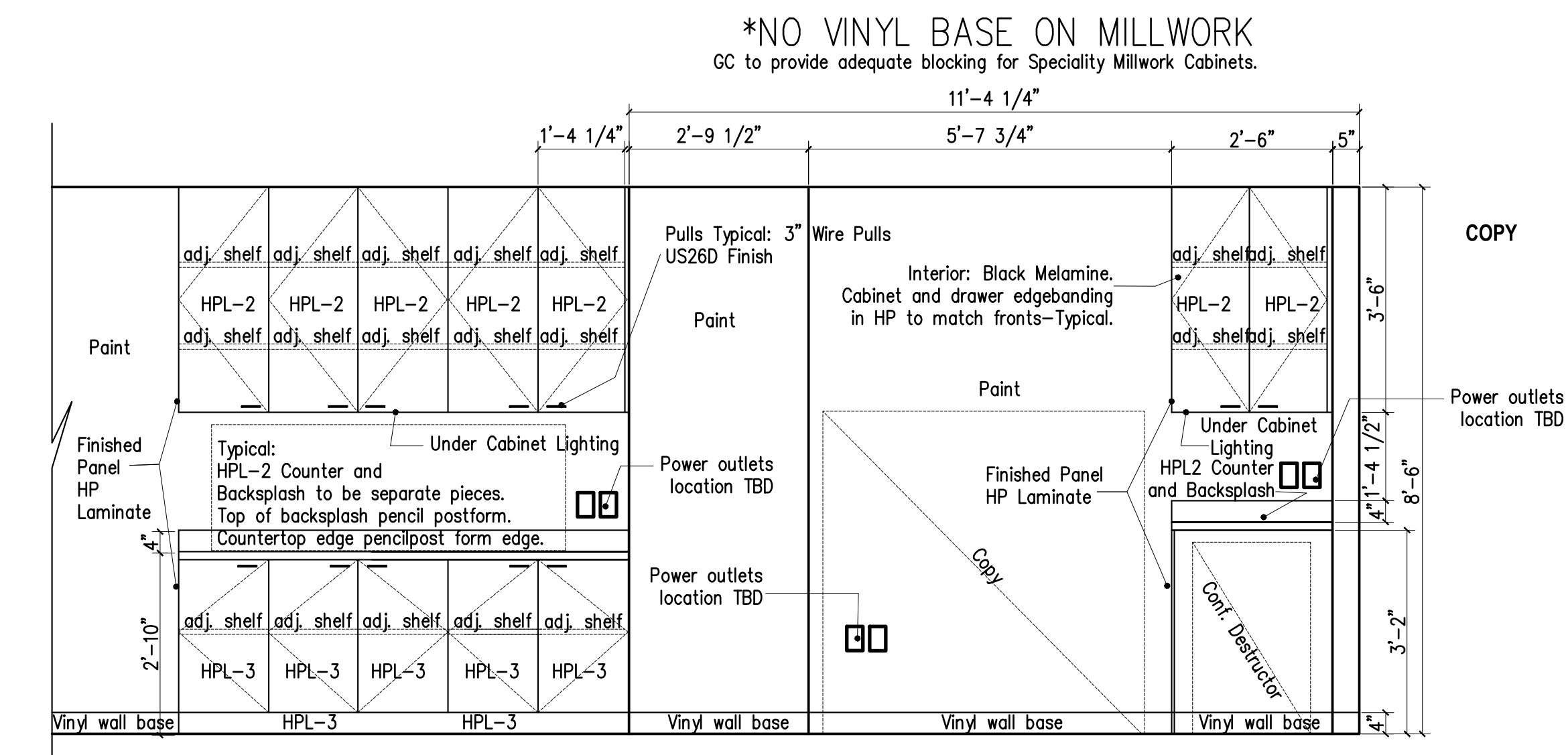

10 COPY 146 - ELEVATION
1/2" = 1'-0"

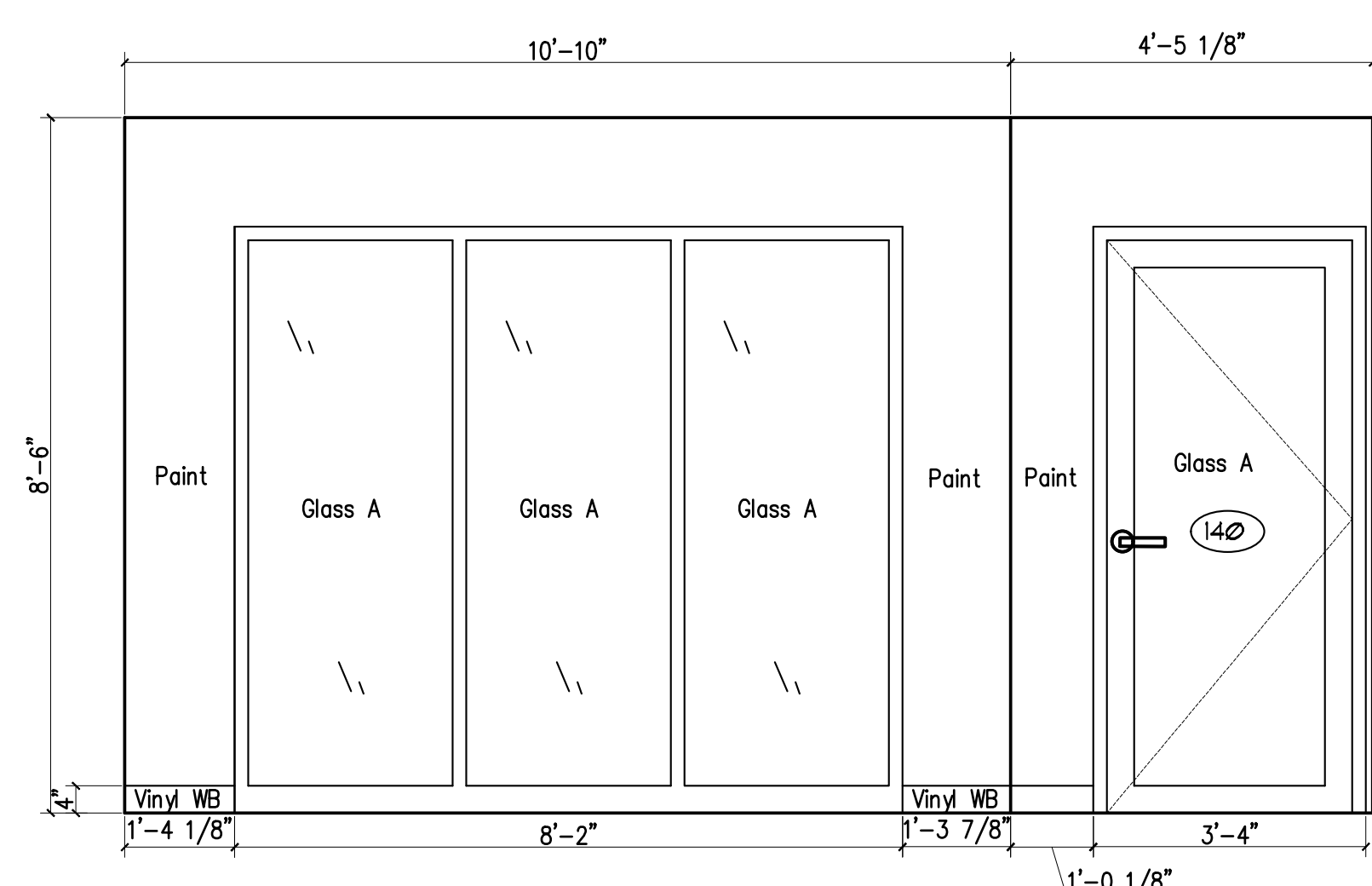

11 OFFICE 140 - ELEVATION
1/2" = 1'-0"

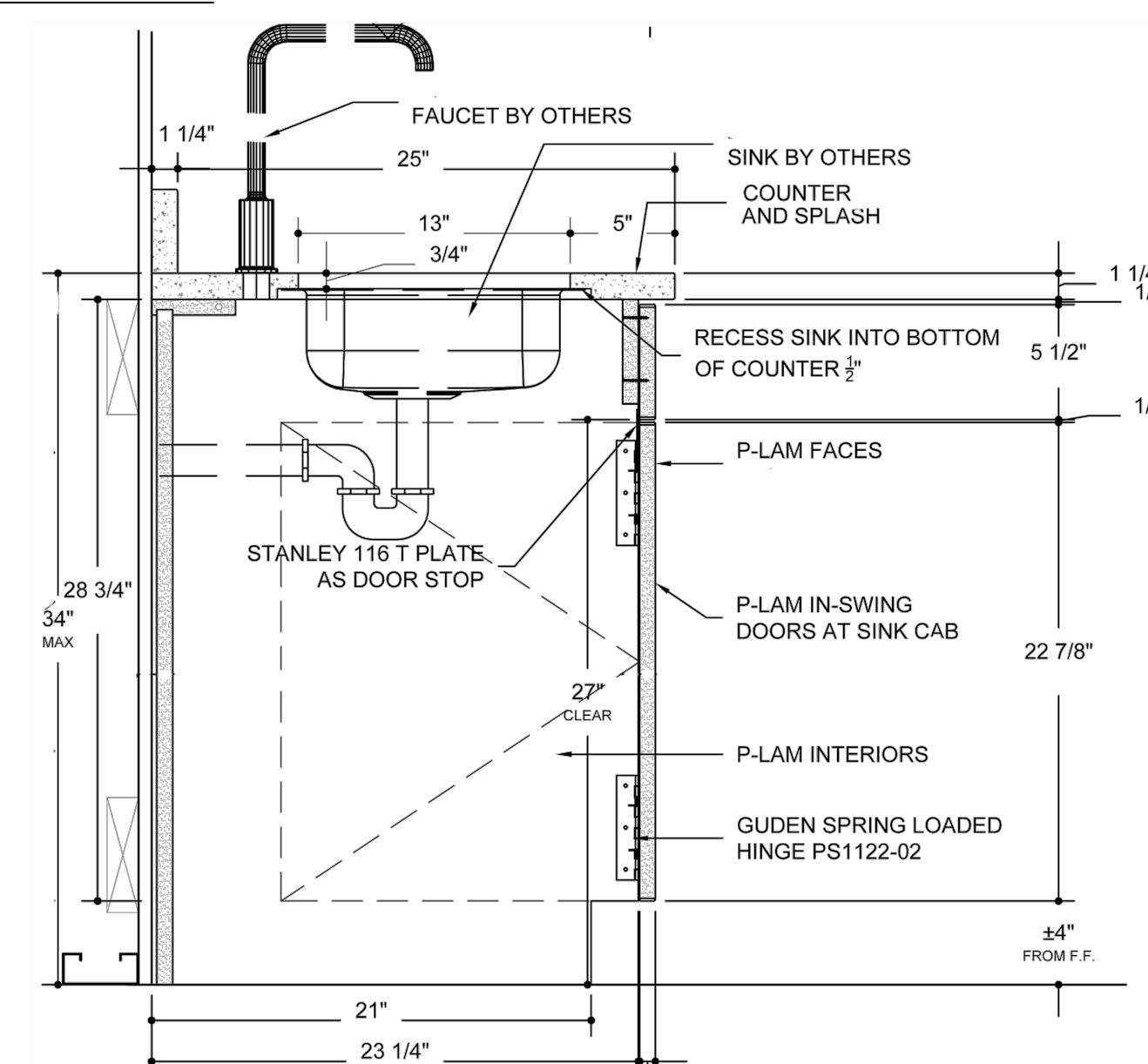

FINISH LEGEND
HPL-1 = WILSONART SKYLINE WALNUT T964K-12 SOFT GRAIN FINISH
HPL-2 = WILSONART CLASSIC LINEN 4943-38 FINE VELVET FINISH
HPL-3 = WILSONART COLUMBIAN WALNUT T943K-38 FINE VELVET FINISH
SS1 = MSI - COLOR: "FROST WHITE"
SS2 = WILSONART QUARTZ - COLOR: "MARRARA" #Q4026
WD1 = TERRAMAI MISSION OAK, ENGINEERED F/P-LEATHER TONGUE AND GROOVE TERRAMAI.COM

REVISED: OCTOBER 02, 2017
PERMIT SET: JULY 14, 2017