

PROJECT MANUAL



**Interior Renovations**  
**One Portland Square**  
**Portland, Maine**

**Project No: 16001**

**"Issued for Construction"**  
**September 21, 2016**

Prepared by:

CANAL  STUDIO

---

Architecture / Planning / Interior Design

**207 553 2115**

One Canal Plaza, Suite 888  
Portland, Maine 04101

\*\*\*\*\*

---

canal5studio.com



PROFESSIONAL SEAL PAGE

Architect  
Canal 5 Studio

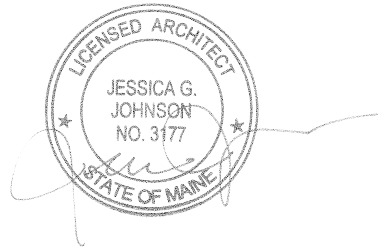

Structural Engineer  
Base Design Group

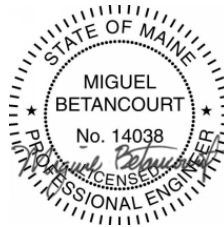

Mechanical Engineer  
Allied Engineering



Electrical Engineer  
Allied Engineering

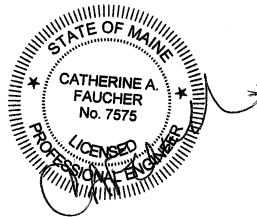





# TABLE OF CONTENTS

SECTIONS	PAGES
<b>DIVISION 01 - GENERAL REQUIREMENTS</b>	
SECTION 011000 - SUMMARY	4
SECTION 012300 - ALTERNATES	2
SECTION 012500 - SUBSTITUTION PROCEDURES	3
SECTION 012600 - CONTRACT MODIFICATION PROCEDURES	2
SECTION 012900 - PAYMENT PROCEDURES	4
SECTION 013100 - PROJECT MANAGEMENT AND COORDINATION	7
SECTION 013200 - CONSTRUCTION PROGRESS DOCUMENTATION	7
SECTION 013300 - SUBMITTAL PROCEDURES	8
SECTION 014000 - QUALITY REQUIREMENTS	8
SECTION 014200 - REFERENCES	2
SECTION 015000 - TEMPORARY FACILITIES AND CONTROLS	7
SECTION 016000 - PRODUCT REQUIREMENTS	5
SECTION 017300 - EXECUTION	7
SECTION 017419 - CONSTRUCTION WASTE MANAGEMENT AND DISPOSAL	6
SECTION 017700 - CLOSEOUT PROCEDURES	6
SECTION 017823 - OPERATION AND MAINTENANCE DATA	7
SECTION 017839 - PROJECT RECORD DOCUMENTS	3
SECTION 017900 - DEMONSTRATION AND TRAINING	5
<b>DIVISION 02 - EXISTING CONDITIONS</b>	
SECTION 024119 - SELECTIVE STRUCTURE DEMOLITION	5
<b>DIVISION 03 – CONCRETE</b>	
SECTION 030130 –CONCRETE REPAIR	4
<b>DIVISION 04 - MASONRY</b>	
NOT USED	
<b>DIVISION 05 - METALS</b>	
SECTION 051200 – STRUCTURAL STEEL FRAMING	14
SECTION 055000 - METAL FABRICATIONS	6
SECTION 057310 – GLAZED DECORATIVE METAL RAILINGS	4
<b>DIVISION 06 - WOOD, PLASTICS, AND COMPOSITES</b>	
SECTION 061000 - ROUGH CARPENTRY	5
SECTION 064023 - INTERIOR ARCHITECTURAL WOODWORK	7
SECTION 066400 – PLASTIC PANELING	2
<b>DIVISION 07 - THERMAL AND MOISTURE PROTECTION</b>	
SECTION 078413 - PENETRATION FIRESTOPPING	4
SECTION 078446 - FIRE-RESISTIVE JOINT SYSTEMS	4
SECTION 079200 - JOINT SEALANTS	7

## **DIVISION 08 - OPENINGS**

SECTION 081113 - HOLLOW METAL FRAMES	4
SECTION 081416 - FLUSH WOOD DOORS	4
SECTION 081433 - STILE AND RAIL WOOD DOORS	4
SECTION 083113 - ACCESS DOORS AND FRAMES	3
SECTION 083480 - AUTOMATIC OVERHEAD COILING FABRIC SMOKE CURTAINS	5
SECTION 084311 - WOOD FRAMED FOLDING GLASS STOREFRONTS	8
SECTION 085200 - WOOD WINDOWS	6
SECTION 087100 - DOOR AND ACCESS CONTROL HARDWARE	30
SECTION 088000 - GLAZING	8
SECTION 088700 - WINDOW FILM	4

## **DIVISION 09 - FINISHES**

SECTION 092216 - NON-STRUCTURAL METAL FRAMING	6
SECTION 092900 - GYPSUM BOARD	3
SECTION 093000 - TILING	6
SECTION 095113 - ACOUSTICAL PANEL CEILINGS	5
SECTION 095426 - SUSPENDED WOOD CEILINGS	10
SECTION 096513 - RESILIENT BASE AND ACCESSORIES	5
SECTION 096516 - RESILIENT SHEET FLOORING	3
SECTION 096570 - RESILIENT TILE FLOORING	4
SECTION 096813 - TILE CARPETING	4
SECTION 096816 - SHEET CARPETING	8
SECTION 097200 - WALL COVERINGS	4
SECTION 099123 - INTERIOR PAINTING	5
SECTION 099300 - STAINING AND TRANSPARENT FINISHING	4

## **DIVISION 10 - SPECIALTIES**

SECTION 102113 - TOILET COMPARTMENTS	5
SECTION 102800 - TOILET AND BATH ACCESSORIES	6
SECTION 104413 - FIRE EXTINGUISHER CABINETS	3

## **DIVISION 11 - EQUIPMENT**

## **DIVISION 12 - FURNISHINGS**

SECTION 122116 - VERTICAL LOUVER BLINDS	3
SECTION 122400 - MOTORIZED WINDOW SHADES	4
SECTION 122413 - ROLLER WINDOW SHADES	4
SECTION 123661 - SIMULATED STONE COUNTERTOPS	2

## **DIVISION 13 - SPECIAL CONSTRUCTION**

NOT USED

## **DIVISION 14 - CONVEYING EQUIPMENT**

NOT USED

## **DIVISION 22 - PLUMBING**

220500	COMMON WORK RESULTS FOR PLUMBING
--------	----------------------------------

220529	HANGERS AND SUPPORTS FOR PLUMBING PIPING AND EQUIPMENT
220553	IDENTIFICATION FOR PLUMBING PIPING & EQUIPMENT
220700	PLUMBING INSULATION
221116	DOMESTIC WATER PIPING
221119	PLUMBING SPECIALTIES
221316	PLUMBING SANITARY AND STORM PIPING
223300	ELECTRIC WATER HEATERS
224000	PLUMBING FIXTURES

**DIVISION 23 - HEATING VENTILATING AND AIR CONDITIONING**

230500	COMMON WORK RESULTS FOR MECHANICAL
230553	IDENTIFICATION FOR MECHANICAL
230593	TESTING, ADJUSTING, AND BALANCING FOR HVAC
230700	MECHANICAL INSULATION
230900	DIRECT DIGITAL CONTROL SYSTEM
233113	DUCTWORK
233423	POWER AND GRAVITY VENTILATORS
233600	AIR TERMINALS
233713	DIFFUSERS, REGISTERS, AND GRILLES
238126	SPLIT-SYSTEM AIR-CONDITIONERS
238130	DUCTLESS SPLIT-SYSTEM AIR-CONDITIONING UNITS

**DIVISION 26 - ELECTRICAL**

261000	BASIC ELECTRICAL REQUIREMENTS
--------	-------------------------------

**DIVISION 27 - 48**

NOT USED

END OF TABLE OF CONTENTS



## SECTION 011000 - SUMMARY

### PART 1 - GENERAL

#### 1.1 SUMMARY

##### A. Section Includes:

1. Project information.
2. Work covered by Contract Documents.
3. Access to site.
4. Work restrictions.
5. Specification and drawing conventions.

##### B. Related Requirements:

1. Section 015000 "Temporary Facilities and Controls" for limitations and procedures governing temporary use of Owner's facilities.

#### 1.2 PROJECT INFORMATION

##### A. Project Identification: Verrill Dana Interior Renovations.

1. Project Location: One Portland Square, Portland, ME.
2. Project Number: 16001.

##### B. Owner: Verrill Dana, LLP.

##### C. Architect: Canal5 Studio.

1. Address: One Canal Plaza, Suite 888.
2. Portland, Maine, 04101.
3. Tel: 207-553-2115.

#### 1.3 WORK COVERED BY CONTRACT DOCUMENTS

##### A. The Work of Project is defined by the Contract Documents and consists of the following:

1. The proposed Verrill Dana Interior Renovations project involves the renovation and fit-up of approximately 64,000 s.f. on floors 7-10 of One Portland Square in Portland, Maine.
2. The existing building is a steel framed structure clad in brick veneer, originally built in 1986. The original Verrill Dana tenant fit up also occurred in 1986.
3. A detailed Construction Management and Phasing Plan will be crucial for all construction work to take place effectively and efficiently and with minimal disruption during construction to existing on-going operations within the law firm.
4. The scope of work includes demolition of interior partitions and ceilings of some areas on floors 7-10, and replacement with new. Other area work will be restricted to new finishes.

Mechanical system upgrades will include new VAV boxes and a digital control system. Electrical, Plumbing, and Fire Protection systems will be modified or replaced with new systems as required.

5. Removal of existing structural floor framing and concrete slab and reinforcement of existing steel floor framing is part of the scope of work. Existing fire protection on the structural steel removed or disturbed will be replaced with new fire proofing to preserve the existing two hour rating on the building structure.
6. The design expectations for the completed Verrill Dana space are for a clean, contemporary, and sophisticated space with new finishes seamlessly integrating with existing finishes.

B. Type of Contract.

1. Project will be constructed under a single prime contract.

1.4 ACCESS TO SITE

A. General: Contractor shall have limited use of Project site for construction operations as indicated on Drawings by the Contract limits and as indicated by requirements of this Section.

B. Use of Site: Limit use of Project site to work in areas indicated. Do not disturb portions of Project site beyond areas in which the Work is indicated.

1. Driveways, Walkways and Entrances: Keep driveways parking garage, loading areas, and entrances serving premises clear and available to Owner, Owner's employees, and emergency vehicles at all times. Do not use these areas for parking or storage of materials.
  - a. Schedule deliveries to minimize use of driveways and entrances by construction operations.
  - b. Schedule deliveries to minimize space and time requirements for storage of materials and equipment on-site.

C. Condition of Existing Building: Maintain portions of existing building affected by construction operations in a weathertight condition throughout construction period. Repair damage caused by construction operations.

1.5 COORDINATION WITH OCCUPANTS

A. Owner Limited Occupancy of Completed Areas of Construction: Owner reserves the right to occupy and to place and install equipment in completed portions of the Work, prior to Substantial Completion of the Work, provided such occupancy does not interfere with completion of the Work. Such placement of equipment and limited occupancy shall not constitute acceptance of the total Work.

1. Architect will prepare a Certificate of Substantial Completion for each specific portion of the Work to be occupied prior to Owner acceptance of the completed Work.
2. Obtain a Certificate of Occupancy from authorities having jurisdiction before limited Owner occupancy.
3. Before limited Owner occupancy, mechanical and electrical systems shall be fully operational, and required tests and inspections shall be successfully completed. On occupancy, Owner will operate and maintain mechanical and electrical systems serving occupied portions of Work.

4. On occupancy, Owner will assume responsibility for maintenance and custodial service for occupied portions of Work.

#### 1.6 WORK RESTRICTIONS

- A. Work Restrictions, General: Comply with restrictions on construction operations.
  1. Comply with limitations on use of public streets and with other requirements of authorities having jurisdiction.
- B. On-Site Work Hours: Limit work in the existing building to normal business working hours of 7:00 a.m. to 5:00 p.m., Monday through Friday, unless otherwise indicated.
- C. Existing Utility Interruptions: Do not interrupt utilities serving facilities occupied by Owner or others unless permitted under the following conditions and then only after providing temporary utility services according to requirements indicated:
  1. Notify Architect not less than two days in advance of proposed utility interruptions.
  2. Obtain Architect's written permission before proceeding with utility interruptions.
- D. Noise, Vibration, and Odors: Coordinate operations that may result in high levels of noise and vibration, odors, or other disruption to Owner occupancy with Owner.
  1. Notify Architect not less than two days in advance of proposed disruptive operations.
  2. Obtain Architect's written permission before proceeding with disruptive operations.
- E. Nonsmoking Building: Smoking is not permitted within the building or within 25 feet of entrances, operable windows, or outdoor-air intakes.
- F. Controlled Substances: Use of tobacco products and other controlled substances on Project site is not permitted.

#### 1.7 SPECIFICATION AND DRAWING CONVENTIONS

- A. Specification Content: The Specifications use certain conventions for the style of language and the intended meaning of certain terms, words, and phrases when used in particular situations. These conventions are as follows:
  1. Imperative mood and streamlined language are generally used in the Specifications. The words "shall," "shall be," or "shall comply with," depending on the context, are implied where a colon (:) is used within a sentence or phrase.
  2. Specification requirements are to be performed by Contractor unless specifically stated otherwise.
- B. Division 01 General Requirements: Requirements of Sections in Division 01 apply to the Work of all Sections in the Specifications.
- C. Drawing Coordination: Requirements for materials and products identified on Drawings are described in detail in the Specifications. One or more of the following are used on Drawings to identify materials and products:

1. Terminology: Materials and products are identified by the typical generic terms used in the individual Specifications Sections.
2. Abbreviations: Materials and products are identified by abbreviations published as part of the U.S. National CAD Standard and scheduled on Drawings.
3. Keynoting: Materials and products are identified by reference keynotes referencing Specification Section numbers found in this Project Manual.

PART 2 - PRODUCTS (Not Used)

PART 3 - EXECUTION (Not Used)

END OF SECTION 011000



## SECTION 012300 - ALTERNATES

### PART 1 - GENERAL

#### 1.1 SUMMARY

- A. Section includes administrative and procedural requirements for alternates.
- B. Related Requirements:
  - 1. Section 016000 "Product Requirements" for requirements for submitting comparable product submittals for products by listed manufacturers.

#### 1.2 DEFINITIONS

- A. Alternate: An amount proposed by bidders for certain work defined in the Bidding Requirements that may be added to or deducted from the Base Bid amount if Owner decides accept a corresponding change in either in the amount of construction to be completed or in the products, materials, equipment, systems, or installation methods described in the Contract Documents.
  - 1. The cost or credit for each alternate is the net addition to or deduction from the Contract Sum to incorporate alternate into the Work. No other adjustments are made to the Contract Sum.
  - 2. Hold pricing for 90 days from date of bid opening to allow Owner time for project accounting. Alternates not accepted before contract signing may be added by Change Order later.

#### 1.3 PROCEDURES

- A. Coordination: Modify or adjust affected adjacent work as necessary to completely integrate work of the alternate into Project:
  - 1. Include as part of each alternate miscellaneous devices, accessory objects, and similar items incidental to or required for a complete installation whether or not indicated as part of alternate.
- B. Notification: Immediately following award of the Contract, notify each party involved, in writing, of the status of each alternate. Indicate if alternates have been accepted, rejected, or deferred for later consideration. Include a complete description of negotiated modifications to alternates.
- C. Execute accepted alternates under the same conditions as other work of the Contract.
- D. Schedule: A Schedule of Alternates is included at the end of this Section. Specification Sections referenced in schedule contain requirements for materials necessary to achieve the work described under each alternate.

PART 2 – PRODUCTS (Not Used)

PART 3 – EXECUTION

3.1 SCHEDULE OF ALTERNATES

- A. Alternate No. 1 – Omit portion of mechanical work that includes the replacement of variable air volume boxes outside of core areas of floors 8, 9, and 10, and replacement of acoustical tile ceilings in same locations. Refer to Drawings A70.2, A70.3, A70.4, M05.2, M05.3, M05.4, M10.2, M10.3, M10.4, M60.0 for scope of work and Specification Section 095113 and Specification Division 23.

END OF SECTION 012300

## SECTION 012500 - SUBSTITUTION PROCEDURES

### PART 1 - GENERAL

#### 1.4 SUMMARY

- A. Section includes administrative and procedural requirements for substitutions.
- B. Related Requirements:
  - 1. Section 016000 "Product Requirements" for requirements for submitting comparable product submittals for products by listed manufacturers.

#### 1.5 DEFINITIONS

- A. Substitutions: Changes in products, materials, equipment, and methods of construction from those required by the Contract Documents and proposed by Contractor.

#### 1.6 ACTION SUBMITTALS

- A. Substitution Requests: Submit three copies of each request for consideration. Identify product or fabrication or installation method to be replaced. Include Specification Section number and title and Drawing numbers and titles.
  - 1. Substitution Request Form: Use facsimile of form provided in Project Manual.
  - 2. Documentation: Show compliance with requirements for substitutions and the following, as applicable:
    - a. Statement indicating why specified product or fabrication or installation cannot be provided, if applicable.
    - b. Coordination information, including a list of changes or revisions needed to other parts of the Work and to construction performed by Owner and separate contractors, that will be necessary to accommodate proposed substitution.
    - c. Detailed comparison of significant qualities of proposed substitution with those of the Work specified. Include annotated copy of applicable Specification Section. Significant qualities may include attributes such as performance, weight, size, durability, visual effect, sustainable design characteristics, warranties, and specific features and requirements indicated. Indicate deviations, if any, from the Work specified.
    - d. Product Data, including drawings and descriptions of products and fabrication and installation procedures.
    - e. Samples, where applicable or requested.
    - f. Certificates and qualification data, where applicable or requested.

- g. List of similar installations for completed projects with project names and addresses and names and addresses of architects and owners.
  - h. Material test reports from a qualified testing agency indicating and interpreting test results for compliance with requirements indicated.
  - i. Research reports evidencing compliance with building code in effect for Project, from ICC-ES.
  - j. Detailed comparison of Contractor's construction schedule using proposed substitution with products specified for the Work, including effect on the overall Contract Time. If specified product or method of construction cannot be provided within the Contract Time, include letter from manufacturer, on manufacturer's letterhead, stating date of receipt of purchase order, lack of availability, or delays in delivery.
  - k. Cost information, including a proposal of change, if any, in the Contract Sum.
  - l. Contractor's certification that proposed substitution complies with requirements in the Contract Documents except as indicated in substitution request, is compatible with related materials, and is appropriate for applications indicated.
  - m. Contractor's waiver of rights to additional payment or time that may subsequently become necessary because of failure of proposed substitution to produce indicated results.
3. Architect's Action: If necessary, Architect will request additional information or documentation for evaluation within seven days of receipt of a request for substitution. Architect will notify Contractor through Construction Manager of acceptance or rejection of proposed substitution within 15 days of receipt of request, or seven days of receipt of additional information or documentation, whichever is later.
- a. Forms of Acceptance: Change Order, Construction Change Directive, or Architect's Supplemental Instructions for minor changes in the Work.
  - b. Use product specified if Architect does not issue a decision on use of a proposed substitution within time allocated.

## 1.7 QUALITY ASSURANCE

- A. Compatibility of Substitutions: Investigate and document compatibility of proposed substitution with related products and materials. Engage a qualified testing agency to perform compatibility tests recommended by manufacturers.

## PART 2 - PRODUCTS

### 3.2 SUBSTITUTIONS

- A. Substitutions for Cause: Submit requests for substitution immediately on discovery of need for change, but not later than 15 days prior to time required for preparation and review of related submittals.
  - 1. Conditions: Architect will consider Contractor's request for substitution when the

following conditions are satisfied:

- a. Requested substitution is consistent with the Contract Documents and will produce indicated results.
- b. Requested substitution provides sustainable design characteristics that specified product provided.
- c. Requested substitution will not adversely affect Contractor's construction schedule.
- d. Requested substitution has received necessary approvals of authorities having jurisdiction.
- e. Requested substitution is compatible with other portions of the Work.
- f. Requested substitution has been coordinated with other portions of the Work.
- g. Requested substitution provides specified warranty.
- h. If requested substitution involves more than one contractor, requested substitution has been coordinated with other portions of the Work, is uniform and consistent, is compatible with other products, and is acceptable to all contractors involved.

B. Substitutions for Convenience: Not allowed unless otherwise indicated.

PART 3 - EXECUTION (Not Used)

END OF SECTION 012500

Issued for Construction

Verrill Dana Interior Renovations  
Portland, Maine  
Project No. 16001

## SECTION 012600 - CONTRACT MODIFICATION PROCEDURES

### PART 1 - GENERAL

#### 1.1 SUMMARY

- A. Section includes administrative and procedural requirements for handling and processing Contract modifications.

#### 1.2 MINOR CHANGES IN THE WORK

- A. Architect will issue, with a copy to the Owner's Representative, supplemental instructions authorizing minor changes in the Work, not involving adjustment to the Contract Sum or the Contract Time, on AIA Document G710, "Architect's Supplemental Instructions."

#### 1.3 PROPOSAL REQUESTS

- A. Owner-Initiated Proposal Requests: The Architect will issue a detailed description of proposed changes in the Work that may require adjustment to the Contract Sum or the Contract Time. If necessary, the description will include supplemental or revised Drawings and Specifications.
  - 1. Work Change Proposal Requests issued by Architect are not instructions either to stop work in progress or to execute the proposed change.
  - 2. Within time specified in Proposal Request after receipt of Proposal Request, submit a quotation estimating cost adjustments to the Contract Sum and the Contract Time necessary to execute the change.
    - a. Include a list of quantities of products required or eliminated and unit costs, with total amount of purchases and credits to be made. If requested, furnish survey data to substantiate quantities.
    - b. Indicate applicable taxes, delivery charges, equipment rental, and amounts of trade discounts.
    - c. Include costs of labor and supervision directly attributable to the change.
    - d. Include an updated Contractor's construction schedule that indicates the effect of the change, including, but not limited to, changes in activity duration, start and finish times, and activity relationship. Use available total float before requesting an extension of the Contract Time.
    - e. Quotation Form: Use forms acceptable to Architect.
- B. Contractor-Initiated Work Change Proposals: If latent or changed conditions require modifications to the Contract, Contractor may initiate a claim by submitting a request for a change to the Architect.

1. Include a statement outlining reasons for the change and the effect of the change on the Work. Provide a complete description of the proposed change. Indicate the effect of the proposed change on the Contract Sum and the Contract Time.
2. Include a list of quantities of products required or eliminated and unit costs, with total amount of purchases and credits to be made. If requested, furnish survey data to substantiate quantities.
3. Indicate applicable taxes, delivery charges, equipment rental, and amounts of trade discounts.
4. Include costs of labor and supervision directly attributable to the change.
5. Include an updated Contractor's construction schedule that indicates the effect of the change, including, but not limited to, changes in activity duration, start and finish times, and activity relationship. Use available total float before requesting an extension of the Contract Time.
6. Comply with requirements in Section 012500 "Substitution Procedures" if the proposed change requires substitution of one product or system for product or system specified.
7. Work Change Proposal Request Form: Use form acceptable to Architect.

#### 1.4 CHANGE ORDER PROCEDURES

- A. On Owner's approval of a Work Changes Proposal Request, Architect will issue a Change Order for signatures of Owner and Contractor on AIA Document G701.

#### 1.5 CONSTRUCTION CHANGE DIRECTIVE

- A. Construction Change Directive: Architect may issue a Construction Change Directive on AIA Document G714. Construction Change Directive instructs Contractor to proceed with a change in the Work, for subsequent inclusion in a Change Order.
  1. Construction Change Directive contains a complete description of change in the Work. It also designates method to be followed to determine change in the Contract Sum or the Contract Time.
- B. Documentation: Maintain detailed records on a time and material basis of work required by the Construction Change Directive.
  1. After completion of change, submit an itemized account and supporting data necessary to substantiate cost and time adjustments to the Contract.

PART 2 - PRODUCTS (Not Used)

PART 3 - EXECUTION (Not Used)

END OF SECTION 012600



## SECTION 012900 - PAYMENT PROCEDURES

### PART 1 - GENERAL

#### 1.1 SUMMARY

- A. Section includes administrative and procedural requirements necessary to prepare and process Applications for Payment.
- B. Related Requirements:
  - 1. Section 012600 "Contract Modification Procedures" for administrative procedures for handling changes to the Contract.
  - 2. Section 013200 "Construction Progress Documentation" for administrative requirements governing the preparation and submittal of the Contractor's construction schedule.

#### 1.2 SCHEDULE OF VALUES

- A. Coordination: Coordinate preparation of the schedule of values with preparation of Contractor's construction schedule. Cost-loaded Critical Path Method Schedule may serve to satisfy requirements for the schedule of values.
  - 1. Coordinate line items in the schedule of values with other required administrative forms and schedules, including the following:
    - a. Application for Payment forms with continuation sheets.
    - b. Submittal schedule.
    - c. Items required to be indicated as separate activities in Contractor's construction schedule.
  - 2. Submit the schedule of values to Architect at earliest possible date but no later than seven days before the date scheduled for submittal of initial Applications for Payment.
- B. Format and Content: Use Project Manual table of contents as a guide to establish line items for the schedule of values. Provide at least one line item for each Specification Section.
  - 1. Identification: Include the following Project identification on the schedule of values:
    - a. Project name and location.
    - b. Name of Architect.
    - c. Architect's project number.
    - d. Contractor's name and address.
    - e. Date of submittal.

2. Provide a breakdown of the Contract Sum in enough detail to facilitate continued evaluation of Applications for Payment and progress reports. Coordinate with Project Manual table of contents. Provide multiple line items for principal subcontract amounts in excess of five percent of the Contract Sum.
  - a. Include separate line items under Contractor and principal subcontracts for Project closeout requirements in an amount totaling five percent of the Contract Sum and subcontract amount.
3. Provide a separate line item in the schedule of values for each part of the Work where Applications for Payment may include materials or equipment purchased or fabricated and stored, but not yet installed.
4. Provide separate line items in the schedule of values for initial cost of materials, for each subsequent stage of completion, and for total installed value of that part of the Work.
5. Each item in the schedule of values and Applications for Payment shall be complete. Include total cost and proportionate share of general overhead and profit for each item.
  - a. Temporary facilities and other major cost items that are not direct cost of actual work-in-place may be shown either as separate line items in the schedule of values or distributed as general overhead expense, at Contractor's option.
6. Schedule Updating: Update and resubmit the schedule of values before the next Applications for Payment when Change Orders or Construction Change Directives result in a change in the Contract Sum.

### 1.3 APPLICATIONS FOR PAYMENT

- A. Each Application for Payment shall be consistent with previous applications and payments as certified by Architect and paid for by Owner.
  1. Initial Application for Payment, Application for Payment at time of Substantial Completion, and final Application for Payment involve additional requirements.
- B. Payment Application Times: The date for each progress payment is indicated in the Agreement between Owner and Contractor. The period of construction work covered by each Application for Payment is the period indicated in the Agreement.
- C. Application for Payment Forms: Use AIA Document G702 and AIA Document G703 as form for Applications for Payment.
- D. Application Preparation: Complete every entry on form. Notarize and execute by a person authorized to sign legal documents on behalf of Contractor. Construction Manager will return incomplete applications without action.
  1. Entries shall match data on the schedule of values and Contractor's construction schedule. Use updated schedules if revisions were made.
  2. Include amounts of Change Orders and Construction Change Directives issued before last day of construction period covered by application.

- E. Transmittal: Submit three signed and notarized original copies of each Application for Payment to Construction Manager by a method ensuring receipt within 24 hours. One copy shall include waivers of lien and similar attachments if required.
1. Transmit each copy with a transmittal form listing attachments and recording appropriate information about application.
- F. Waivers of Mechanic's Lien: With each Application for Payment, submit waivers of mechanic's lien from entities lawfully entitled to file a mechanic's lien arising out of the Contract and related to the Work covered by the payment.
1. Submit partial waivers on each item for amount requested in previous application, after deduction for retainage, on each item.
  2. When an application shows completion of an item, submit conditional final or full waivers.
  3. Owner reserves the right to designate which entities involved in the Work must submit waivers.
  4. Waiver Forms: Submit executed waivers of lien on forms acceptable to Owner.
- G. Initial Application for Payment: Administrative actions and submittals that must precede or coincide with submittal of first Application for Payment include the following:
1. List of subcontractors.
  2. Schedule of values.
  3. Contractor's construction schedule (preliminary if not final).
  4. Submittal schedule (preliminary if not final).
  5. List of Contractor's staff assignments.
  6. List of Contractor's principal consultants.
  7. Copies of building permits.
  8. Copies of authorizations and licenses from authorities having jurisdiction for performance of the Work.
  9. Initial progress report.
  10. Report of preconstruction conference.
  11. Certificates of insurance and insurance policies.
- H. Application for Payment at Substantial Completion: After Architect issues the Certificate of Substantial Completion, submit an Application for Payment showing 100 percent completion for portion of the Work claimed as substantially complete.
1. Include documentation supporting claim that the Work is substantially complete and a statement showing an accounting of changes to the Contract Sum.
  2. This application shall reflect Certificates of Partial Substantial Completion issued previously for Owner occupancy of designated portions of the Work.
- I. Final Payment Application: After completing Project closeout requirements, submit final Application for Payment with releases and supporting documentation not previously submitted and accepted, including, but not limited, to the following:
1. Evidence of completion of Project closeout requirements.

2. Insurance certificates for products and completed operations where required and proof that taxes, fees, and similar obligations were paid.
3. Updated final statement, accounting for final changes to the Contract Sum.
4. AIA Document G706-1994, "Contractor's Affidavit of Payment of Debts and Claims."
5. AIA Document G706A-1994, "Contractor's Affidavit of Release of Liens."
6. AIA Document G707-1994, "Consent of Surety to Final Payment."
7. Evidence that claims have been settled.
8. Final meter readings for utilities, a measured record of stored fuel, and similar data as of date of Substantial Completion or when Owner took possession of and assumed responsibility for corresponding elements of the Work.
9. Final liquidated damages settlement statement.

PART 2 - PRODUCTS (Not Used)

PART 3 - EXECUTION (Not Used)

END OF SECTION 012900

## SECTION 013100 - PROJECT MANAGEMENT AND COORDINATION

### PART 1 - GENERAL

#### 1.1 SUMMARY

- A. Section includes administrative provisions for coordinating construction operations on Project including, but not limited to, the following:
  - 1. Coordination drawings.
  - 2. Requests for Information (RFIs).
  - 3. Project meetings.
- B. Related Requirements:
  - 1. Section 017300 "Execution" for procedures for coordinating general installation and field-engineering services, including establishment of benchmarks and control points.

#### 1.2 DEFINITIONS

- A. RFI: Request from Owner, Construction Manager, Architect, or Contractor seeking information required by or clarifications of the Contract Documents.

#### 1.3 INFORMATIONAL SUBMITTALS

- A. Subcontract List: Prepare a written summary identifying individuals or firms proposed for each portion of the Work, including those who are to furnish products or equipment fabricated to a special design. Include the following information in tabular form:
  - 1. Name, address, and telephone number of entity performing subcontract or supplying products.
  - 2. Number and title of related Specification Section(s) covered by subcontract.
  - 3. Drawing number and detail references, as appropriate, covered by subcontract.

#### 1.4 GENERAL COORDINATION PROCEDURES

- A. Coordination: Coordinate construction operations included in different Sections of the Specifications to ensure efficient and orderly installation of each part of the Work. Coordinate construction operations, included in different Sections, that depend on each other for proper installation, connection, and operation.
  - 1. Schedule construction operations in sequence required to obtain the best results where installation of one part of the Work depends on installation of other components, before

- or after its own installation.
  - 2. Coordinate installation of different components to ensure maximum performance and accessibility for required maintenance, service, and repair.
  - 3. Make adequate provisions to accommodate items scheduled for later installation.
- B. Prepare memoranda for distribution to each party involved, outlining special procedures required for coordination. Include such items as required notices, reports, and list of attendees at meetings.
- 1. Prepare similar memoranda for Owner and separate contractors if coordination of their Work is required.
- C. Administrative Procedures: Coordinate scheduling and timing of required administrative procedures with other construction activities to avoid conflicts and to ensure orderly progress of the Work. Such administrative activities include, but are not limited to, the following:
- 1. Preparation of Contractor's construction schedule.
  - 2. Preparation of the schedule of values.
  - 3. Installation and removal of temporary facilities and controls.
  - 4. Delivery and processing of submittals.
  - 5. Progress meetings.
  - 6. Preinstallation conferences.
  - 7. Project closeout activities.
  - 8. Startup and adjustment of systems.

## 1.5 COORDINATION DRAWINGS

- A. Coordination Drawings, General: Prepare coordination drawings according to requirements in individual Sections, where installation is not completely shown on Shop Drawings, where limited space availability necessitates coordination, or if coordination is required to facilitate integration of products and materials fabricated or installed by more than one entity.
- 1. Content: Project-specific information, drawn accurately to a scale large enough to indicate and resolve conflicts. Do not base coordination drawings on standard printed data. Include the following information, as applicable:
    - a. Indicate functional and spatial relationships of components of architectural, structural, civil, mechanical, and electrical systems.
    - b. Indicate dimensions shown on the Drawings. Specifically note dimensions that appear to be in conflict with submitted equipment and minimum clearance requirements. Provide alternate sketches to Architect indicating proposed resolution of such conflicts. Minor dimension changes and difficult installations will not be considered changes to the Contract.
- B. Coordination Drawing Organization: Organize coordination drawings as follows:
- 1. Floor Plans and Reflected Ceiling Plans: Show architectural and structural elements, and mechanical, plumbing, fire-protection, fire-alarm, and electrical Work. Show

- locations of visible ceiling-mounted devices relative to acoustical ceiling grid.
2. Plenum Space: Indicate subframing for support of ceiling and wall systems, mechanical and electrical equipment, and related Work. Locate components within ceiling plenum to accommodate layout of light fixtures indicated on Drawings.
3. Mechanical Rooms: Provide coordination drawings for mechanical rooms showing plans and elevations of mechanical, plumbing, fire-protection, fire-alarm, and electrical equipment.
4. Structural Penetrations: Indicate penetrations and openings required for all disciplines.
5. Slab Edge and Embedded Items: Indicate slab edge locations and sizes and locations of embedded items for metal fabrications, sleeves, anchor bolts, bearing plates, angles, door floor closers, slab depressions for floor finishes, curbs and housekeeping pads, and similar items.
6. Review: Architect will review coordination drawings to confirm that the Work is being coordinated, but not for the details of the coordination, which are Contractor's responsibility.

#### 1.6 REQUESTS FOR INFORMATION (RFIs)

- A. General: Immediately on discovery of the need for additional information or interpretation of the Contract Documents, Contractor shall prepare and submit an RFI in the form specified.
  1. Architect will return RFIs submitted to Architect by other entities controlled by Contractor with no response.
  2. Coordinate and submit RFIs in a prompt manner so as to avoid delays in Contractor's work or work of subcontractors.
- B. Content of the RFI: Include a detailed, legible description of item needing information or interpretation and the following:
  1. Project name.
  2. Project number.
  3. Date.
  4. Name of Contractor.
  5. Name of Architect and Construction Manager.
  6. RFI number, numbered sequentially.
  7. RFI subject.
  8. Specification Section number and title and related paragraphs, as appropriate.
  9. Drawing number and detail references, as appropriate.
  10. Field dimensions and conditions, as appropriate.
  11. Contractor's suggested resolution. If Contractor's solution(s) impacts the Contract Time or the Contract Sum, Contractor shall state impact in the RFI.
  12. Contractor's signature.
  13. Attachments: Include sketches, descriptions, measurements, photos, Product Data, Shop Drawings, coordination drawings, and other information necessary to fully describe items needing interpretation.
- C. RFI Forms: AIA Document G716.

- D. Architect's Action: Architect will review each RFI, determine action required, and respond. Allow seven working days for Architect's response for each RFI. RFIs received by Architect after 1:00 p.m. will be considered as received the following working day.
1. The following RFIs will be returned without action:
    - a. Requests for approval of submittals.
    - b. Requests for approval of substitutions.
    - c. Requests for coordination information already indicated in the Contract Documents.
    - d. Requests for adjustments in the Contract Time or the Contract Sum.
    - e. Requests for interpretation of Architect's actions on submittals.
    - f. Incomplete RFIs or inaccurately prepared RFIs.
  2. Architect's action may include a request for additional information, in which case Architect's time for response will date from time of receipt of additional information.
  3. Architect's action on RFIs that may result in a change to the Contract Time or the Contract Sum may be eligible for Contractor to submit Change Proposal according to Section 012600 "Contract Modification Procedures."
    - a. If Contractor believes the RFI response warrants change in the Contract Time or the Contract Sum, notify Architect in writing within 10 days of receipt of the RFI response.
- E. RFI Log: Prepare, maintain, and submit a tabular log of RFIs organized by the RFI number. Submit log weekly. Include the following:
1. Project name.
  2. Name and address of Contractor.
  3. Name and address of Architect and Construction Manager.
  4. RFI number including RFIs that were dropped and not submitted.
  5. RFI description.
  6. Date the RFI was submitted.
  7. Date Architect's and Construction Manager's response was received.
- F. On receipt of Architect's action, update the RFI log and immediately distribute the RFI response to affected parties. Review response and notify Architect within seven days if Contractor disagrees with response.
1. Identification of related Minor Change in the Work, Construction Change Directive, and Proposal Request, as appropriate.
  2. Identification of related Field Order, Work Change Directive, and Proposal Request, as appropriate.



## 1.7 PROJECT MEETINGS

- A. General: Construction Manager will schedule and conduct meetings and conferences at Project site unless otherwise indicated.
1. Attendees: Inform participants and others involved, and individuals whose presence is required, of date and time of each meeting. Notify Owner and Architect of scheduled meeting dates and times.
  2. Agenda: Prepare the meeting agenda. Distribute the agenda to all invited attendees.
  3. Minutes: Entity responsible for conducting meeting will record significant discussions and agreements achieved. Distribute the meeting minutes to everyone concerned, including Owner, Construction Manager, and Architect, within three days of the meeting.
- B. Preconstruction Conference: Construction Manager will schedule and conduct a preconstruction conference before starting construction, at a time convenient to Owner and Architect, but no later than 15 days after execution of the Agreement.
1. Attendees: Authorized representatives of Owner, Construction Manager, Architect, and their consultants; Contractor and its superintendent; major subcontractors; suppliers; and other concerned parties shall attend the conference. Participants at the conference shall be familiar with Project and authorized to conclude matters relating to the Work.
  2. Agenda: Discuss items of significance that could affect progress, including the following:
    - a. Tentative construction schedule.
    - b. Phasing.
    - c. Critical work sequencing and long-lead items.
    - d. Designation of key personnel and their duties.
    - e. Procedures for processing field decisions and Change Orders.
    - f. Procedures for RFIs.
    - g. Procedures for testing and inspecting.
    - h. Procedures for processing Applications for Payment.
    - i. Distribution of the Contract Documents.
    - j. Submittal procedures.
    - k. Preparation of record documents.
    - l. Use of the premises and existing building.
    - m. Work restrictions.
    - n. Working hours.
    - o. Owner's occupancy requirements.
    - p. Responsibility for temporary facilities and controls.
    - q. Procedures for moisture and mold control.
    - r. Procedures for disruptions and shutdowns.
    - s. Construction waste management and recycling.
    - t. Parking availability.
    - u. Office, work, and storage areas.
    - v. Equipment deliveries and priorities.
    - w. First aid.
    - x. Security.
    - y. Progress cleaning.

3. Minutes: Entity responsible for conducting meeting will record and distribute meeting minutes.
- C. Preinstallation Conferences: Conduct a preinstallation conference at Project site before each construction activity that requires coordination with other construction.
1. Attendees: Installer and representatives of manufacturers and fabricators involved in or affected by the installation and its coordination or integration with other materials and installations that have preceded or will follow, shall attend the meeting. Advise Architect, Construction Manager of scheduled meeting dates.
  2. Agenda: Review progress of other construction activities and preparations for the particular activity under consideration, including requirements for the following:
    - a. Contract Documents.
    - b. Options.
    - c. Related RFIs.
    - d. Related Change Orders.
    - e. Purchases.
    - f. Deliveries.
    - g. Submittals.
    - h. Review of mockups.
    - i. Possible conflicts.
    - j. Compatibility problems.
    - k. Time schedules.
    - l. Weather limitations.
    - m. Manufacturer's written instructions.
    - n. Warranty requirements.
    - o. Compatibility of materials.
    - p. Acceptability of substrates.
    - q. Temporary facilities and controls.
    - r. Space and access limitations.
    - s. Regulations of authorities having jurisdiction.
    - t. Testing and inspecting requirements.
    - u. Installation procedures.
    - v. Coordination with other work.
    - w. Required performance results.
    - x. Protection of adjacent work.
    - y. Protection of construction and personnel.
  3. Record significant conference discussions, agreements, and disagreements, including required corrective measures and actions.
  4. Reporting: Distribute minutes of the meeting to each party present and to other parties requiring information.
  5. Do not proceed with installation if the conference cannot be successfully concluded. Initiate whatever actions are necessary to resolve impediments to performance of the Work and reconvene the conference at earliest feasible date.
- D. Progress Meetings: Construction Manager will conduct progress meetings at regular intervals.

1. Attendees: In addition to representatives of Owner, Construction Manager, and Architect, each contractor, subcontractor, supplier, and other entity concerned with current progress or involved in planning, coordination, or performance of future activities shall be represented at these meetings. All participants at the meeting shall be familiar with Project and authorized to conclude matters relating to the Work.
2. Agenda: Review and correct or approve minutes of previous progress meeting. Review other items of significance that could affect progress. Include topics for discussion as appropriate to status of Project.
  - a. Contractor's Construction Schedule: Review progress since the last meeting. Determine whether each activity is on time, ahead of schedule, or behind schedule, in relation to Contractor's construction schedule. Determine how construction behind schedule will be expedited; secure commitments from parties involved to do so. Discuss whether schedule revisions are required to ensure that current and subsequent activities will be completed within the Contract Time.
    - 1) Review schedule for next period.
  - b. Review present and future needs of each entity present, including the following:
    - 1) Interface requirements.
    - 2) Sequence of operations.
    - 3) Status of submittals.
    - 4) Deliveries.
    - 5) Off-site fabrication.
    - 6) Access.
    - 7) Site utilization.
    - 8) Temporary facilities and controls.
    - 9) Progress cleaning.
    - 10) Quality and work standards.
    - 11) Status of correction of deficient items.
    - 12) Field observations.
    - 13) Status of RFIs.
    - 14) Status of proposal requests.
    - 15) Pending changes.
    - 16) Status of Change Orders.
    - 17) Pending claims and disputes.
    - 18) Documentation of information for payment requests.
3. Minutes: Entity responsible for conducting the meeting will record and distribute the meeting minutes to each party present and to parties requiring information.
  - a. Schedule Updating: Revise Contractor's construction schedule after each progress meeting where revisions to the schedule have been made or recognized. Issue revised schedule concurrently with the report of each meeting.

Issued for Construction

Verrill Dana Interior Renovations  
Portland, Maine  
Project No. 16001

PART 2 - PRODUCTS (Not Used)

PART 3 - EXECUTION (Not Used)

END OF SECTION 013100

## SECTION 013200 - CONSTRUCTION PROGRESS DOCUMENTATION

### PART 1 - GENERAL

#### 1.1 SUMMARY

- A. Section includes administrative and procedural requirements for documenting the progress of construction during performance of the Work, including the following:
  - 1. Contractor's construction schedule.
  - 2. Construction schedule updating reports.
  - 3. Daily construction reports.
  - 4. Site condition reports.

#### 1.2 DEFINITIONS

- A. Activity: A discrete part of a project that can be identified for planning, scheduling, monitoring, and controlling the construction project. Activities included in a construction schedule consume time and resources.
  - 1. Critical Activity: An activity on the critical path that must start and finish on the planned early start and finish times.
  - 2. Predecessor Activity: An activity that precedes another activity in the network.
  - 3. Successor Activity: An activity that follows another activity in the network.
- B. CPM: Critical path method, which is a method of planning and scheduling a construction project where activities are arranged based on activity relationships. Network calculations determine when activities can be performed and the critical path of Project.
- C. Critical Path: The longest connected chain of interdependent activities through the network schedule that establishes the minimum overall Project duration and contains no float.
- D. Float: The measure of leeway in starting and completing an activity.
  - 1. Float time is not for the exclusive use or benefit of either Owner or Contractor, but is a jointly owned, expiring Project resource available to both parties as needed to meet schedule milestones and Contract completion date.

#### 1.3 INFORMATIONAL SUBMITTALS

- A. Format for Submittals: Submit required submittals in the following format:

1. Working electronic copy of schedule file, where indicated.
- B. Startup Network Diagram: Of size required to display entire network for entire construction period. Show logic ties for activities.
- C. Contractor's Construction Schedule: Initial schedule, of size required to display entire schedule for entire construction period.
  1. Submit a working electronic copy of schedule, using software indicated, and labeled to comply with requirements for submittals. Include type of schedule (initial or updated) and date on label.
- D. CPM Reports: Concurrent with CPM schedule, submit each of the following reports. Format for each activity in reports shall contain activity number, activity description, original duration, remaining duration, early start date, early finish date, late start date, late finish date, and total float in calendar days.
  1. Activity Report: List of all activities sorted by activity number and then early start date, or actual start date if known.
  2. Logic Report: List of preceding and succeeding activities for all activities, sorted in ascending order by activity number and then early start date, or actual start date if known.
  3. Total Float Report: List of all activities sorted in ascending order of total float.
  4. Earnings Report: Compilation of Contractor's total earnings from commencement of the Work until most recent Application for Payment.
- E. Construction Schedule Updating Reports: Submit with Applications for Payment.
- F. Daily Construction Reports: Submit at weekly intervals.
- G. Site Condition Reports: Submit at time of discovery of differing conditions.

#### 1.4 COORDINATION

- A. Coordinate Contractor's construction schedule with the schedule of values, list of subcontracts, submittal schedule, progress reports, payment requests, and other required schedules and reports.
  1. Secure time commitments for performing critical elements of the Work from entities involved.
  2. Coordinate each construction activity in the network with other activities and schedule them in proper sequence.

## PART 2 - PRODUCTS

## 2.1 CONTRACTOR'S CONSTRUCTION SCHEDULE, GENERAL

- A. Time Frame: Extend schedule from date established for commencement of the Work to date of Substantial Completion.
1. Contract completion date shall not be changed by submission of a schedule that shows an early completion date, unless specifically authorized by Change Order.
- B. Activities: Treat each story or separate area as a separate numbered activity for each main element of the Work. Comply with the following:
1. Activity Duration: Define activities so no activity is longer than 20 days, unless specifically allowed by Architect.
  2. Procurement Activities: Include procurement process activities for the following long lead items and major items, requiring a cycle of more than 60 days, as separate activities in schedule. Procurement cycle activities include, but are not limited to, submittals, approvals, purchasing, fabrication, and delivery.
  3. Submittal Review Time: Include review and resubmittal times indicated in Section 013300 "Submittal Procedures" in schedule. Coordinate submittal review times in Contractor's construction schedule with submittal schedule.
  4. Startup and Testing Time: Include no fewer than 15 days for startup and testing.
  5. Substantial Completion: Indicate completion in advance of date established for Substantial Completion, and allow time for Architect's and Construction Manager's administrative procedures necessary for certification of Substantial Completion.
  6. Punch List and Final Completion: Include not more than 30 days for completion of punch list items and final completion.
- C. Constraints: Include constraints and work restrictions indicated in the Contract Documents and as follows in schedule, and show how the sequence of the Work is affected.
1. Work Restrictions: Show the effect of the following items on the schedule:
    - a. Coordination with existing construction.
    - b. Limitations of continued occupancies.
    - c. Uninterruptible services.
    - d. Partial occupancy before Substantial Completion.
    - e. Use of premises restrictions.
    - f. Provisions for future construction.
    - g. Seasonal variations.
    - h. Environmental control.
  2. Work Stages: Indicate important stages of construction for each major portion of the Work.
- D. Milestones: Include milestones indicated in the Contract Documents in schedule, including, but not limited to, the Notice to Proceed, Substantial Completion, and final completion.

- E. Upcoming Work Summary: Prepare summary report indicating activities scheduled to occur or commence prior to submittal of next schedule update. Summarize the following issues:
1. Unresolved issues.
  2. Unanswered Requests for Information.
  3. Rejected or unreturned submittals.
  4. Notations on returned submittals.
  5. Pending modifications affecting the Work and Contract Time.
- F. Recovery Schedule: When periodic update indicates the Work is 14 or more calendar days behind the current approved schedule, submit a separate recovery schedule indicating means by which Contractor intends to regain compliance with the schedule.

## 2.2 CONTRACTOR'S CONSTRUCTION SCHEDULE (GANTT CHART)

- A. Gantt-Chart Schedule: Submit a comprehensive, fully developed, horizontal, Gantt-chart-type, Contractor's construction schedule within 30 days of date established for commencement of the Work.
- B. Preparation: Indicate each significant construction activity separately. Identify first workday of each week with a continuous vertical line.
1. For construction activities that require three months or longer to complete, indicate an estimated completion percentage in 10 percent increments within time bar.

## 2.3 CONTRACTOR'S CONSTRUCTION SCHEDULE (CPM SCHEDULE)

- A. General: Prepare network diagrams using AON (activity-on-node) format.
- B. Startup Network Diagram: Submit diagram within 14 days of date established for commencement of the Work. Outline significant construction activities for the first 90 days of construction. Include skeleton diagram for the remainder of the Work and a cash requirement prediction based on indicated activities.
- C. CPM Schedule: Prepare Contractor's construction schedule using a cost- and resource-loaded, time-scaled CPM network analysis diagram for the Work.
1. Develop network diagram in sufficient time to submit CPM schedule so it can be accepted for use no later than 60 days after date established for commencement of the Work.
    - a. Failure to include any work item required for performance of this Contract shall not excuse Contractor from completing all work within applicable completion dates, regardless of Architect's approval of the schedule.
  2. Establish procedures for monitoring and updating CPM schedule and for reporting progress. Coordinate procedures with progress meeting and payment request dates.



3. Use "one workday" as the unit of time for individual activities. Indicate nonworking days and holidays incorporated into the schedule in order to coordinate with the Contract Time.
- D. CPM Schedule Preparation: Prepare a list of all activities required to complete the Work. Using the startup network diagram, prepare a skeleton network to identify probable critical paths.
1. Activities: Indicate the estimated time duration, sequence requirements, and relationship of each activity in relation to other activities. Include estimated time frames for the following activities:
    - a. Preparation and processing of submittals.
    - b. Mobilization and demobilization.
    - c. Purchase of materials.
    - d. Delivery.
    - e. Fabrication.
    - f. Utility interruptions.
    - g. Installation.
    - h. Work by Owner that may affect or be affected by Contractor's activities.
    - i. Testing and commissioning.
    - j. Punch list and final completion.
    - k. Activities occurring following final completion.
  2. Critical Path Activities: Identify critical path activities, including those for interim completion dates. Scheduled start and completion dates shall be consistent with Contract milestone dates.
  3. Processing: Process data to produce output data on a computer-drawn, time-scaled network. Revise data, reorganize activity sequences, and reproduce as often as necessary to produce the CPM schedule within the limitations of the Contract Time.
  4. Format: Mark the critical path. Locate the critical path near center of network; locate paths with most float near the edges.
    - a. Subnetworks on separate sheets are permissible for activities clearly off the critical path.
- E. Contract Modifications: For each proposed contract modification and concurrent with its submission, prepare a time-impact analysis using a network fragment to demonstrate the effect of the proposed change on the overall project schedule.
- F. Initial Issue of Schedule: Prepare initial network diagram from a sorted activity list indicating straight "early start-total float." Identify critical activities. Prepare tabulated reports showing the following:
1. Contractor or subcontractor and the Work or activity.
  2. Description of activity.
  3. Main events of activity.
  4. Immediate preceding and succeeding activities.
  5. Early and late start dates.

6. Early and late finish dates.
7. Activity duration in workdays.
8. Total float or slack time.
9. Average size of workforce.
10. Dollar value of activity (coordinated with the schedule of values).

G. Schedule Updating: Concurrent with making revisions to schedule, prepare tabulated reports showing the following:

1. Identification of activities that have changed.
2. Changes in early and late start dates.
3. Changes in early and late finish dates.
4. Changes in activity durations in workdays.
5. Changes in the critical path.
6. Changes in total float or slack time.
7. Changes in the Contract Time.

## 2.4 REPORTS

A. Daily Construction Reports: Prepare a daily construction report recording the following information concerning events at Project site:

1. List of subcontractors at Project site.
2. List of separate contractors at Project site.
3. Approximate count of personnel at Project site.
4. Equipment at Project site.
5. Material deliveries.
6. High and low temperatures and general weather conditions, including presence of rain or snow.
7. Accidents.
8. Meetings and significant decisions.
9. Unusual events.
10. Stoppages, delays, shortages, and losses.
11. Meter readings and similar recordings.
12. Emergency procedures.
13. Orders and requests of authorities having jurisdiction.
14. Change Orders received and implemented.
15. Construction Change Directives received and implemented.
16. Services connected and disconnected.
17. Equipment or system tests and startups.
18. Partial completions and occupancies.
19. Substantial Completions authorized.

B. Site Condition Reports: Immediately on discovery of a difference between site conditions and the Contract Documents, prepare and submit a detailed report. Submit with a Request for Information. Include a detailed description of the differing conditions, together with recommendations for changing the Contract Documents.

## PART 3 - EXECUTION

### 3.1 CONTRACTOR'S CONSTRUCTION SCHEDULE

- A. Contractor's Construction Schedule Updating: At monthly intervals, update schedule to reflect actual construction progress and activities. Issue schedule one week before each regularly scheduled progress meeting.
  - 1. Revise schedule immediately after each meeting or other activity where revisions have been recognized or made. Issue updated schedule concurrently with the report of each such meeting.
  - 2. Include a report with updated schedule that indicates every change, including, but not limited to, changes in logic, durations, actual starts and finishes, and activity durations.
  - 3. As the Work progresses, indicate final completion percentage for each activity.
  
- B. Distribution: Distribute copies of approved schedule to Architect, Construction Manager, Owner, separate contractors, testing and inspecting agencies, and other parties identified by Contractor with a need-to-know schedule responsibility.
  - 1. Post copies in Project meeting rooms and temporary field offices.
  - 2. When revisions are made, distribute updated schedules to the same parties and post in the same locations. Delete parties from distribution when they have completed their assigned portion of the Work and are no longer involved in performance of construction activities.

END OF SECTION 013200

Issued for Construction

Verrill Dana Interior Renovations  
Portland, Maine  
Project No. 16001

## SECTION 013300 - SUBMITTAL PROCEDURES

### PART 1 - GENERAL

#### 1.1 SUMMARY

- A. Section includes requirements for the submittal schedule and administrative and procedural requirements for submitting Shop Drawings, Product Data, Samples, and other submittals.
- B. Related Requirements:
  - 1. Section 013200 "Construction Progress Documentation" for submitting schedules and reports, including Contractor's construction schedule.
  - 2. Section 017823 "Operation and Maintenance Data" for submitting operation and maintenance manuals.
  - 3. Section 017839 "Project Record Documents" for submitting record Drawings, record Specifications, and record Product Data.

#### 1.2 DEFINITIONS

- A. Action Submittals: Written and graphic information and physical samples that require Architect's responsive action.
- B. Informational Submittals: Written and graphic information and physical samples that do not require Architect's responsive action. Submittals may be rejected for not complying with requirements.

#### 1.3 ACTION SUBMITTALS

- A. Submittal Schedule: Submit a schedule of submittals, arranged in chronological order by dates required by construction schedule. Include time required for review, ordering, manufacturing, fabrication, and delivery when establishing dates. Include additional time required for making corrections or revisions to submittals noted by Architect and additional time for handling and reviewing submittals required by those corrections.

#### 1.4 SUBMITTAL ADMINISTRATIVE REQUIREMENTS

- A. Architect's Digital Data Files: Electronic copies of digital data files of the Contract Drawings will not be provided by Architect for Contractor's use in preparing submittals.
- B. Coordination: Coordinate preparation and processing of submittals with performance of construction activities.

1. Coordinate each submittal with fabrication, purchasing, testing, delivery, other submittals, and related activities that require sequential activity.
  2. Coordinate transmittal of different types of submittals for related parts of the Work so processing will not be delayed because of need to review submittals concurrently for coordination.
    - a. Architect reserve the right to withhold action on a submittal requiring coordination with other submittals until related submittals are received.
- C. Processing Time: Allow time for submittal review, including time for resubmittals, as follows. Time for review shall commence on Architect's receipt of submittal. No extension of the Contract Time will be authorized because of failure to transmit submittals enough in advance of the Work to permit processing, including resubmittals.
1. Initial Review: Allow 15 days for initial review of each submittal. Allow additional time if coordination with subsequent submittals is required. Architect will advise Contractor when a submittal being processed must be delayed for coordination.
  2. Intermediate Review: If intermediate submittal is necessary, process it in same manner as initial submittal.
  3. Resubmittal Review: Allow 15 days for review of each resubmittal.
- D. Electronic Submittals: Identify and incorporate information in each electronic submittal file as follows:
1. Assemble complete submittal package into a single indexed file incorporating submittal requirements of a single Specification Section and transmittal form with links enabling navigation to each item.
  2. Name file with submittal number or other unique identifier, including revision identifier.
    - a. File name shall use project identifier and Specification Section number followed by a decimal point and then a sequential number (e.g., LNHS-061000.01). Resubmittals shall include an alphabetic suffix after another decimal point (e.g., LNHS-061000.01.A).
  3. Provide means for insertion to permanently record Contractor's review and approval markings and action taken by Architect and Construction Manager.
  4. Transmittal Form for Electronic Submittals: Use electronic form acceptable to Owner, containing the following information:
    - a. Project name.
    - b. Date.
    - c. Name and address of Architect.
    - d. Name of Construction Manager.
    - e. Name of Contractor.
    - f. Name of firm or entity that prepared submittal.
    - g. Names of subcontractor, manufacturer, and supplier.
    - h. Category and type of submittal.
    - i. Submittal purpose and description.

- j. Specification Section number and title.
  - k. Specification paragraph number or drawing designation and generic name for each of multiple items.
  - l. Drawing number and detail references, as appropriate.
  - m. Location(s) where product is to be installed, as appropriate.
  - n. Related physical samples submitted directly.
  - o. Indication of full or partial submittal.
  - p. Transmittal number, numbered consecutively.
  - q. Submittal and transmittal distribution record.
  - r. Other necessary identification.
  - s. Remarks.
5. Metadata: Include the following information as keywords in the electronic submittal file metadata:
- a. Project name.
  - b. Number and title of appropriate Specification Section.
  - c. Manufacturer name.
  - d. Product name.
- E. Options: Identify options requiring selection by Architect.
- F. Deviations: Identify deviations from the Contract Documents on submittals.
- G. Resubmittals: Make resubmittals in same form and number of copies as initial submittal.
- 1. Note date and content of previous submittal.
  - 2. Note date and content of revision in label or title block and clearly indicate extent of revision.
  - 3. Resubmit submittals until they are marked with approval notation from Architect's and Construction Manager's action stamp.
- H. Distribution: Furnish copies of final submittals to manufacturers, subcontractors, suppliers, fabricators, installers, authorities having jurisdiction, and others as necessary for performance of construction activities. Show distribution on transmittal forms.
- I. Use for Construction: Retain complete copies of submittals on Project site. Use only final action submittals that are marked with approval notation from Architect's and Construction Manager's action stamp.

## PART 2 - PRODUCTS

### 2.1 SUBMITTAL PROCEDURES

- A. General Submittal Procedure Requirements:
- 1. Submit electronic submittals via email as PDF electronic files.

- a. Architect will return annotated file. Annotate and retain one copy of file as an electronic Project record document file.
2. Certificates and Certifications Submittals: Provide a statement that includes signature of entity responsible for preparing certification. Certificates and certifications shall be signed by an officer or other individual authorized to sign documents on behalf of that entity.
  - a. Provide a digital signature with digital certificate on electronically-submitted certificates and certifications where indicated.
- B. Product Data: Collect information into a single submittal for each element of construction and type of product or equipment.
  1. If information must be specially prepared for submittal because standard published data are not suitable for use, submit as Shop Drawings, not as Product Data.
  2. Mark each copy of each submittal to show which products and options are applicable.
  3. Include the following information, as applicable:
    - a. Manufacturer's catalog cuts.
    - b. Manufacturer's product specifications.
    - c. Standard color charts.
    - d. Statement of compliance with specified referenced standards.
    - e. Testing by recognized testing agency.
    - f. Application of testing agency labels and seals.
    - g. Notation of coordination requirements.
    - h. Availability and delivery time information.
  4. For equipment, include the following in addition to the above, as applicable:
    - a. Wiring diagrams showing factory-installed wiring.
    - b. Printed performance curves.
    - c. Operational range diagrams.
    - d. Clearances required to other construction, if not indicated on accompanying Shop Drawings.
  5. Submit Product Data before or concurrent with Samples.
  6. Submit Product Data in the following format:
    - a. PDF electronic file.
- C. Shop Drawings: Prepare Project-specific information, drawn accurately to scale. Do not base Shop Drawings on reproductions of the Contract Documents or standard printed data, unless submittal based on Architect's digital data drawing files is otherwise permitted.
  1. Preparation: Fully illustrate requirements in the Contract Documents. Include the following information, as applicable:
    - a. Identification of products.



- b. Schedules.
  - c. Compliance with specified standards.
  - d. Notation of coordination requirements.
  - e. Notation of dimensions established by field measurement.
  - f. Relationship and attachment to adjoining construction clearly indicated.
  - g. Seal and signature of professional engineer if specified.
2. Submit Shop Drawings in the following format:
    - a. PDF electronic file.
- D. Samples: Submit Samples for review of kind, color, pattern, and texture for a check of these characteristics with other elements and for a comparison of these characteristics between submittal and actual component as delivered and installed.
1. Transmit Samples that contain multiple, related components such as accessories together in one submittal package.
  2. Identification: Attach label on unexposed side of Samples that includes the following:
    - a. Generic description of Sample.
    - b. Product name and name of manufacturer.
    - c. Sample source.
    - d. Number and title of applicable Specification Section.
  3. For projects where electronic submittals are required, provide corresponding electronic submittal of Sample transmittal, digital image file illustrating Sample characteristics, and identification information for record.
  4. Disposition: Maintain sets of approved Samples at Project site, available for quality-control comparisons throughout the course of construction activity. Sample sets may be used to determine final acceptance of construction associated with each set.
    - a. Samples that may be incorporated into the Work are indicated in individual Specification Sections. Such Samples must be in an undamaged condition at time of use.
    - b. Samples not incorporated into the Work, or otherwise designated as Owner's property, are the property of Contractor.
  5. Samples for Initial Selection: Submit manufacturer's color charts consisting of units or sections of units showing the full range of colors, textures, and patterns available.
    - a. Number of Samples: Submit one full set(s) of available choices where color, pattern, texture, or similar characteristics are required to be selected from manufacturer's product line. Architect will return submittal with options selected.
  6. Samples for Verification: Submit full-size units or Samples of size indicated, prepared from same material to be used for the Work, cured and finished in manner specified, and physically identical with material or product proposed for use, and that show full range of color and texture variations expected. Samples include, but are not limited to, the

following: partial sections of manufactured or fabricated components; small cuts or containers of materials; complete units of repetitively used materials; swatches showing color, texture, and pattern; color range sets; and components used for independent testing and inspection.

- a. Number of Samples: Submit three sets of Samples. Architect and Construction Manager will retain two Sample sets; remainder will be returned. Mark up and retain one returned Sample set as a project record sample.
  - 1) If variation in color, pattern, texture, or other characteristic is inherent in material or product represented by a Sample, submit at least three sets of paired units that show approximate limits of variations.
- E. Product Schedule: As required in individual Specification Sections, prepare a written summary indicating types of products required for the Work and their intended location. Include the following information in tabular form:
  1. Submit product schedule in the following format:
    - a. PDF electronic file.
- F. Coordination Drawings Submittals: Comply with requirements specified in Section 013100 "Project Management and Coordination."
- G. Contractor's Construction Schedule: Comply with requirements specified in Section 013200 "Construction Progress Documentation."
- H. Application for Payment and Schedule of Values: Comply with requirements specified in Section 012900 "Payment Procedures."
- I. Test and Inspection Reports and Schedule of Tests and Inspections Submittals: Comply with requirements specified in Section 014000 "Quality Requirements."
- J. Closeout Submittals and Maintenance Material Submittals: Comply with requirements specified in Section 017700 "Closeout Procedures."
- K. Maintenance Data: Comply with requirements specified in Section 017823 "Operation and Maintenance Data."
- L. Qualification Data: Prepare written information that demonstrates capabilities and experience of firm or person. Include lists of completed projects with project names and addresses, contact information of architects and owners, and other information specified.
- M. Welding Certificates: Prepare written certification that welding procedures and personnel comply with requirements in the Contract Documents. Submit record of Welding Procedure Specification and Procedure Qualification Record on AWS forms. Include names of firms and personnel certified.
- N. Installer Certificates: Submit written statements on manufacturer's letterhead certifying that

Installer complies with requirements in the Contract Documents and, where required, is authorized by manufacturer for this specific Project.

- O. Manufacturer Certificates: Submit written statements on manufacturer's letterhead certifying that manufacturer complies with requirements in the Contract Documents. Include evidence of manufacturing experience where required.
- P. Product Certificates: Submit written statements on manufacturer's letterhead certifying that product complies with requirements in the Contract Documents.
- Q. Material Certificates: Submit written statements on manufacturer's letterhead certifying that material complies with requirements in the Contract Documents.
- R. Material Test Reports: Submit reports written by a qualified testing agency, on testing agency's standard form, indicating and interpreting test results of material for compliance with requirements in the Contract Documents.
- S. Product Test Reports: Submit written reports indicating that current product produced by manufacturer complies with requirements in the Contract Documents. Base reports on evaluation of tests performed by manufacturer and witnessed by a qualified testing agency, or on comprehensive tests performed by a qualified testing agency.
- T. Research Reports: Submit written evidence, from a model code organization acceptable to authorities having jurisdiction, that product complies with building code in effect for Project.
- U. Schedule of Tests and Inspections: Comply with requirements specified in Section 014000 "Quality Requirements."
- V. Preconstruction Test Reports: Submit reports written by a qualified testing agency, on testing agency's standard form, indicating and interpreting results of tests performed before installation of product, for compliance with performance requirements in the Contract Documents.
- W. Compatibility Test Reports: Submit reports written by a qualified testing agency, on testing agency's standard form, indicating and interpreting results of compatibility tests performed before installation of product. Include written recommendations for primers and substrate preparation needed for adhesion.
- X. Field Test Reports: Submit written reports indicating and interpreting results of field tests performed either during installation of product or after product is installed in its final location, for compliance with requirements in the Contract Documents.
- Y. Design Data: Prepare and submit written and graphic information, including, but not limited to, performance and design criteria, list of applicable codes and regulations, and calculations. Include list of assumptions and other performance and design criteria and a summary of loads. Include load diagrams if applicable. Provide name and version of software, if any, used for calculations. Include page numbers.

## 2.2 DELEGATED-DESIGN SERVICES

- A. Performance and Design Criteria: Where professional design services or certifications by a design professional are specifically required of Contractor by the Contract Documents, provide products and systems complying with specific performance and design criteria indicated.
  - 1. If criteria indicated are not sufficient to perform services or certification required, submit a written request for additional information to Architect.
- B. Delegated-Design Services Certification: In addition to Shop Drawings, Product Data, and other required submittals, submit digitally signed PDF electronic file for each product and system specifically assigned to Contractor to be designed or certified by a design professional.
  - 1. Indicate that products and systems comply with performance and design criteria in the Contract Documents. Include list of codes, loads, and other factors used in performing these services.

## PART 3 - EXECUTION

### 3.1 CONTRACTOR'S REVIEW

- A. Action and Informational Submittals: Review each submittal and check for coordination with other Work of the Contract and for compliance with the Contract Documents. Note corrections and field dimensions. Mark with approval stamp before submitting to Architect.
- B. Project Closeout and Maintenance Material Submittals: See requirements in Section 017700 "Closeout Procedures."
- C. Approval Stamp: Stamp each submittal with a uniform, approval stamp. Include Project name and location, submittal number, Specification Section title and number, name of reviewer, date of Contractor's approval, and statement certifying that submittal has been reviewed, checked, and approved for compliance with the Contract Documents.

### 3.2 ARCHITECT'S AND CONSTRUCTION MANAGER'S ACTION

- A. General: Architect and Construction Manager will not review submittals that do not bear Contractor's approval stamp and will return them without action.
- B. Action Submittals: Architect and Construction Manager will review each submittal, make marks to indicate corrections or revisions required, and return it. Architect and Construction Manager will stamp each submittal with an action stamp and will mark stamp appropriately to indicate action.
- C. Informational Submittals: Architect and Construction Manager will review each submittal and will not return it, or will return it if it does not comply with requirements. Architect and

Construction Manager will forward each submittal to appropriate party.

- D. Incomplete submittals are unacceptable, will be considered nonresponsive, and will be returned for resubmittal without review.
- E. Submittals not required by the Contract Documents may not be reviewed and may be discarded.

END OF SECTION 013300

Issued for Construction

Verrill Dana Interior Renovations  
Portland, Maine  
Project No. 16001

## SECTION 014000 - QUALITY REQUIREMENTS

### PART 1 - GENERAL

#### 1.1 SUMMARY

- A. Section includes administrative and procedural requirements for quality assurance and quality control.
- B. Testing and inspecting services are required to verify compliance with requirements specified or indicated. These services do not relieve Contractor of responsibility for compliance with the Contract Document requirements.
  - 1. Specified tests, inspections, and related actions do not limit Contractor's other quality-assurance and -control procedures that facilitate compliance with the Contract Document requirements.
  - 2. Requirements for Contractor to provide quality-assurance and -control services required by Architect, Owner, Construction Manager, or authorities having jurisdiction are not limited by provisions of this Section.
  - 3. Specific test and inspection requirements are not specified in this Section.

#### 1.2 DEFINITIONS

- A. Quality-Assurance Services: Activities, actions, and procedures performed before and during execution of the Work to guard against defects and deficiencies and substantiate that proposed construction will comply with requirements.
- B. Quality-Control Services: Tests, inspections, procedures, and related actions during and after execution of the Work to evaluate that actual products incorporated into the Work and completed construction comply with requirements. Services do not include contract enforcement activities performed by Architect or Construction Manager.
- C. Mockups: Full-size physical assemblies that are constructed on-site. Mockups are constructed to verify selections made under Sample submittals; to demonstrate aesthetic effects and, where indicated, qualities of materials and execution; to review coordination, testing, or operation; to show interface between dissimilar materials; and to demonstrate compliance with specified installation tolerances. Mockups are not Samples. Unless otherwise indicated, approved mockups establish the standard by which the Work will be judged.
  - 1. Laboratory Mockups: Full-size physical assemblies constructed at testing facility to verify performance characteristics.
- D. Preconstruction Testing: Tests and inspections performed specifically for Project before products and materials are incorporated into the Work, to verify performance or compliance with specified criteria.

- E. Product Testing: Tests and inspections that are performed by an NRTL, an NVLAP, or a testing agency qualified to conduct product testing and acceptable to authorities having jurisdiction, to establish product performance and compliance with specified requirements.
- F. Source Quality-Control Testing: Tests and inspections that are performed at the source, e.g., plant, mill, factory, or shop.
- G. Field Quality-Control Testing: Tests and inspections that are performed on-site for installation of the Work and for completed Work.
- H. Testing Agency: An entity engaged to perform specific tests, inspections, or both. Testing laboratory shall mean the same as testing agency.
- I. Installer/Applicator/Erector: Contractor or another entity engaged by Contractor as an employee, Subcontractor, or Sub-subcontractor, to perform a particular construction operation, including installation, erection, application, and similar operations.
  - 1. Use of trade-specific terminology in referring to a trade or entity does not require that certain construction activities be performed by accredited or unionized individuals, or that requirements specified apply exclusively to specific trade(s).
- J. Experienced: When used with an entity or individual, "experienced" means having successfully completed a minimum of five previous projects similar in nature, size, and extent to this Project; being familiar with special requirements indicated; and having complied with requirements of authorities having jurisdiction.

### 1.3 CONFLICTING REQUIREMENTS

- A. Referenced Standards: If compliance with two or more standards is specified and the standards establish different or conflicting requirements for minimum quantities or quality levels, comply with the most stringent requirement. Refer conflicting requirements that are different, but apparently equal, to Architect for a decision before proceeding.
- B. Minimum Quantity or Quality Levels: The quantity or quality level shown or specified shall be the minimum provided or performed. The actual installation may comply exactly with the minimum quantity or quality specified, or it may exceed the minimum within reasonable limits. To comply with these requirements, indicated numeric values are minimum or maximum, as appropriate, for the context of requirements. Refer uncertainties to Architect for a decision before proceeding.

### 1.4 INFORMATIONAL SUBMITTALS

- A. Contractor's Statement of Responsibility: When required by authorities having jurisdiction, submit copy of written statement of responsibility sent to authorities having jurisdiction before starting work on the following systems:
  - 1. Seismic-force-resisting system, designated seismic system, or component listed in the



- designated seismic system quality-assurance plan prepared by Architect.
2. Main wind-force-resisting system or a wind-resisting component listed in the wind-force-resisting system quality-assurance plan prepared by Architect.

- B. Testing Agency Qualifications: For testing agencies specified in "Quality Assurance" Article to demonstrate their capabilities and experience. Include proof of qualifications in the form of a recent report on the inspection of the testing agency by a recognized authority.

## 1.5 REPORTS AND DOCUMENTS

- A. Test and Inspection Reports: Prepare and submit certified written reports specified in other Sections. Include the following:

1. Date of issue.
2. Project title and number.
3. Name, address, and telephone number of testing agency.
4. Dates and locations of samples and tests or inspections.
5. Names of individuals making tests and inspections.
6. Description of the Work and test and inspection method.
7. Identification of product and Specification Section.
8. Complete test or inspection data.
9. Test and inspection results and an interpretation of test results.
10. Record of temperature and weather conditions at time of sample taking and testing and inspecting.
11. Comments or professional opinion on whether tested or inspected Work complies with the Contract Document requirements.
12. Name and signature of laboratory inspector.
13. Recommendations on retesting and reinspecting.

- B. Manufacturer's Field Reports: Prepare written information documenting tests and inspections specified in other Sections. Include the following:

1. Name, address, and telephone number of representative making report.
2. Statement on condition of substrates and their acceptability for installation of product.
3. Summary of installation procedures being followed, whether they comply with requirements and, if not, what corrective action was taken.
4. Results of operational and other tests and a statement of whether observed performance complies with requirements.
5. Other required items indicated in individual Specification Sections.

- C. Permits, Licenses, and Certificates: For Owner's records, submit copies of permits, licenses, certifications, inspection reports, releases, jurisdictional settlements, notices, receipts for fee payments, judgments, correspondence, records, and similar documents, established for compliance with standards and regulations bearing on performance of the Work.

## 1.6 QUALITY ASSURANCE

- A. General: Qualifications paragraphs in this article establish the minimum qualification levels required; individual Specification Sections specify additional requirements.
- B. Manufacturer Qualifications: A firm experienced in manufacturing products or systems similar to those indicated for this Project and with a record of successful in-service performance, as well as sufficient production capacity to produce required units.
- C. Fabricator Qualifications: A firm experienced in producing products similar to those indicated for this Project and with a record of successful in-service performance, as well as sufficient production capacity to produce required units.
- D. Installer Qualifications: A firm or individual experienced in installing, erecting, or assembling work similar in material, design, and extent to that indicated for this Project, whose work has resulted in construction with a record of successful in-service performance.
- E. Professional Engineer Qualifications: A professional engineer who is legally qualified to practice in jurisdiction where Project is located and who is experienced in providing engineering services of the kind indicated. Engineering services are defined as those performed for installations of the system, assembly, or product that are similar in material, design, and extent to those indicated for this Project.
- F. Specialists: Certain Specification Sections require that specific construction activities shall be performed by entities who are recognized experts in those operations. Specialists shall satisfy qualification requirements indicated and shall be engaged for the activities indicated.
  - 1. Requirements of authorities having jurisdiction shall supersede requirements for specialists.
- G. Testing Agency Qualifications: An NRTL, an NVLAP, or an independent agency with the experience and capability to conduct testing and inspecting indicated, as documented according to ASTM E 329; and with additional qualifications specified in individual Sections; and, where required by authorities having jurisdiction, that is acceptable to authorities.
  - 1. NRTL: A nationally recognized testing laboratory according to 29 CFR 1910.7.
  - 2. NVLAP: A testing agency accredited according to NIST's National Voluntary Laboratory Accreditation Program.
- H. Manufacturer's Representative Qualifications: An authorized representative of manufacturer who is trained and approved by manufacturer to observe and inspect installation of manufacturer's products that are similar in material, design, and extent to those indicated for this Project.
- I. Preconstruction Testing: Where testing agency is indicated to perform preconstruction testing for compliance with specified requirements for performance and test methods, comply with the following:
  - 1. Contractor responsibilities include the following:

- a. Provide test specimens representative of proposed products and construction.
  - b. Submit specimens in a timely manner with sufficient time for testing and analyzing results to prevent delaying the Work.
  - c. Build laboratory mockups at testing facility using personnel, products, and methods of construction indicated for the completed Work.
  - d. When testing is complete, remove test specimens, assemblies, and mockups, and laboratory mockups; do not reuse products on Project.
2. Testing Agency Responsibilities: Submit a certified written report of each test, inspection, and similar quality-assurance service to Architect, through Construction Manager, with copy to Contractor. Interpret tests and inspections and state in each report whether tested and inspected work complies with or deviates from the Contract Documents.
- J. Mockups: Before installing portions of the Work requiring mockups, build mockups for each form of construction and finish required to comply with the following requirements, using materials indicated for the completed Work:
1. Build mockups in location and of size indicated or, if not indicated, as directed by Architect or Construction Manager.
  2. Notify Architect and Construction Manager seven days in advance of dates and times when mockups will be constructed.
  3. Demonstrate the proposed range of aesthetic effects and workmanship.
  4. Obtain Architect's and Construction Manager's approval of mockups before starting work, fabrication, or construction.
    - a. Allow seven days for initial review and each re-review of each mockup.
  5. Maintain mockups during construction in an undisturbed condition as a standard for judging the completed Work.
  6. Demolish and remove mockups when directed unless otherwise indicated.
- K. Laboratory Mockups: Comply with requirements of preconstruction testing and those specified in individual Specification Sections.

## 1.7 QUALITY CONTROL

- A. Owner Responsibilities: Where quality-control services are indicated as Owner's responsibility, Owner will engage a qualified testing agency to perform these services.
1. Owner will furnish Contractor with names, addresses, and telephone numbers of testing agencies engaged and a description of types of testing and inspecting they are engaged to perform.
  2. Costs for retesting and reinspecting construction that replaces or is necessitated by work that failed to comply with the Contract Documents will be charged to Contractor, and the Contract Sum will be adjusted by Change Order.
- B. Contractor Responsibilities: Tests and inspections not explicitly assigned to Owner are

Contractor's responsibility. Perform additional quality-control activities required to verify that the Work complies with requirements, whether specified or not.

1. Where services are indicated as Contractor's responsibility, engage a qualified testing agency to perform these quality-control services.
    - a. Contractor shall not employ same entity engaged by Owner, unless agreed to in writing by Owner.
  2. Notify testing agencies at least 24 hours in advance of time when Work that requires testing or inspecting will be performed.
  3. Where quality-control services are indicated as Contractor's responsibility, submit a certified written report, in duplicate, of each quality-control service.
  4. Testing and inspecting requested by Contractor and not required by the Contract Documents are Contractor's responsibility.
  5. Submit additional copies of each written report directly to authorities having jurisdiction, when they so direct.
- C. **Manufacturer's Field Services:** Where indicated, engage a manufacturer's representative to observe and inspect the Work. Manufacturer's representative's services include examination of substrates and conditions, verification of materials, inspection of completed portions of the Work, and submittal of written reports.
- D. **Retesting/Reinspecting:** Regardless of whether original tests or inspections were Contractor's responsibility, provide quality-control services, including retesting and reinspecting, for construction that replaced Work that failed to comply with the Contract Documents.
- E. **Testing Agency Responsibilities:** Cooperate with Architect, Construction Manager, and Contractor in performance of duties. Provide qualified personnel to perform required tests and inspections.
  1. Notify Architect, Construction Manager, and Contractor promptly of irregularities or deficiencies observed in the Work during performance of its services.
  2. Determine the location from which test samples will be taken and in which in-situ tests are conducted.
  3. Conduct and interpret tests and inspections and state in each report whether tested and inspected work complies with or deviates from requirements.
  4. Submit a certified written report, in duplicate, of each test, inspection, and similar quality-control service through Contractor.
  5. Do not release, revoke, alter, or increase the Contract Document requirements or approve or accept any portion of the Work.
  6. Do not perform any duties of Contractor.

F. **Associated Services:** Cooperate with agencies performing required tests, inspections, and similar quality-control services, and provide reasonable auxiliary services as requested. Notify agency sufficiently in advance of operations to permit assignment of personnel. Provide the following:
  1. Access to the Work.

2. Incidental labor and facilities necessary to facilitate tests and inspections.
  3. Adequate quantities of representative samples of materials that require testing and inspecting. Assist agency in obtaining samples.
  4. Facilities for storage and field curing of test samples.
  5. Delivery of samples to testing agencies.
  6. Preliminary design mix proposed for use for material mixes that require control by testing agency.
  7. Security and protection for samples and for testing and inspecting equipment at Project site.
- G. Coordination: Coordinate sequence of activities to accommodate required quality-assurance and -control services with a minimum of delay and to avoid necessity of removing and replacing construction to accommodate testing and inspecting.
1. Schedule times for tests, inspections, obtaining samples, and similar activities.

## 1.8 SPECIAL TESTS AND INSPECTIONS

- A. Special Tests and Inspections: Engage a qualified testing agency to conduct special tests and inspections required by authorities having jurisdiction as the responsibility of Owner, and as follows:
1. Verifying that manufacturer maintains detailed fabrication and quality-control procedures and reviews the completeness and adequacy of those procedures to perform the Work.
  2. Notifying Architect and Contractor promptly of irregularities and deficiencies observed in the Work during performance of its services.
  3. Submitting a certified written report of each test, inspection, and similar quality-control service to Architect, through Construction Manager, with copy to Contractor and to authorities having jurisdiction.
  4. Submitting a final report of special tests and inspections at Substantial Completion, which includes a list of unresolved deficiencies.
  5. Interpreting tests and inspections and stating in each report whether tested and inspected work complies with or deviates from the Contract Documents.
  6. Retesting and reinspecting corrected work.

## PART 2 - PRODUCTS (Not Used)

## PART 3 - EXECUTION

### 3.1 TEST AND INSPECTION LOG

- A. Test and Inspection Log: Prepare a record of tests and inspections. Include the following:
1. Date test or inspection was conducted.
  2. Description of the Work tested or inspected.

3. Date test or inspection results were transmitted to Architect.
  4. Identification of testing agency or special inspector conducting test or inspection.
- B. Maintain log at Project site. Post changes and revisions as they occur. Provide access to test and inspection log for Architect's reference during normal working hours.

### 3.2 REPAIR AND PROTECTION

- A. General: On completion of testing, inspecting, sample taking, and similar services, repair damaged construction and restore substrates and finishes.
1. Provide materials and comply with installation requirements specified in other Specification Sections or matching existing substrates and finishes. Restore patched areas and extend restoration into adjoining areas with durable seams that are as invisible as possible. Comply with the Contract Document requirements for cutting and patching in Section 017300 "Execution."
- B. Protect construction exposed by or for quality-control service activities.
- C. Repair and protection are Contractor's responsibility, regardless of the assignment of responsibility for quality-control services.

END OF SECTION 014000

## SECTION 014200 - REFERENCES

### PART 1 - GENERAL

#### 1.1 DEFINITIONS

- A. General: Basic Contract definitions are included in the Conditions of the Contract.
- B. "Approved": When used to convey Architect's action on Contractor's submittals, applications, and requests, "approved" is limited to Architect's duties and responsibilities as stated in the Conditions of the Contract.
- C. "Directed": A command or instruction by Architect. Other terms including "requested," "authorized," "selected," "required," and "permitted" have the same meaning as "directed."
- D. "Indicated": Requirements expressed by graphic representations or in written form on Drawings, in Specifications, and in other Contract Documents. Other terms including "shown," "noted," "scheduled," and "specified" have the same meaning as "indicated."
- E. "Regulations": Laws, ordinances, statutes, and lawful orders issued by authorities having jurisdiction, and rules, conventions, and agreements within the construction industry that control performance of the Work.
- F. "Furnish": Supply and deliver to Project site, ready for unloading, unpacking, assembly, installation, and similar operations.
- G. "Install": Unload, temporarily store, unpack, assemble, erect, place, anchor, apply, work to dimension, finish, cure, protect, clean, and similar operations at Project site.
- H. "Provide": Furnish and install, complete and ready for the intended use.
- I. "Project Site": Space available for performing construction activities. The extent of Project site is shown on Drawings and may or may not be identical with the description of the land on which Project is to be built.

#### 1.2 INDUSTRY STANDARDS

- A. Applicability of Standards: Unless the Contract Documents include more stringent requirements, applicable construction industry standards have the same force and effect as if bound or copied directly into the Contract Documents to the extent referenced. Such standards are made a part of the Contract Documents by reference.
- B. Publication Dates: Comply with standards in effect as of date of the Contract Documents unless otherwise indicated.

- C. Copies of Standards: Each entity engaged in construction on Project should be familiar with industry standards applicable to its construction activity. Copies of applicable standards are not bound with the Contract Documents.
  - 1. Where copies of standards are needed to perform a required construction activity, obtain copies directly from publication source.

### 1.3 ABBREVIATIONS AND ACRONYMS

- A. Industry Organizations: Where abbreviations and acronyms are used in Specifications or other Contract Documents, they shall mean the recognized name of the entities indicated in Gale's "Encyclopedia of Associations: National Organizations of the U.S." or in Columbia Books' "National Trade & Professional Associations of the United States."
- B. Code Agencies: Where abbreviations and acronyms are used in Specifications or other Contract Documents, they shall mean the recognized name of the entities in the following list.
  - 1. IAPMO - International Association of Plumbing and Mechanical Officials; [www.iapmo.org](http://www.iapmo.org).
  - 2. ICC - International Code Council; [www.iccsafe.org](http://www.iccsafe.org).
  - 3. ICC-ES - ICC Evaluation Service, LLC; [www.icc-es.org](http://www.icc-es.org).
- C. Federal Government Agencies: Where abbreviations and acronyms are used in Specifications or other Contract Documents, they shall mean the recognized name of the entities in the following list.
  - 1. OSHA - Occupational Safety & Health Administration; [www.osha.gov](http://www.osha.gov).
- D. Standards and Regulations: Where abbreviations and acronyms are used in Specifications or other Contract Documents, they shall mean the recognized name of the standards and regulations in the following list.
  - 1. USAB - United States Access Board; [www.access-board.gov](http://www.access-board.gov).

PART 2 - PRODUCTS (Not Used)

PART 3 - EXECUTION (Not Used)

END OF SECTION 014200



## SECTION 015000 - TEMPORARY FACILITIES AND CONTROLS

### PART 1 - GENERAL

#### 1.1 SUMMARY

- A. Section includes requirements for temporary utilities, support facilities, and security and protection facilities.
- B. Related Requirements:
  - 1. Section 011000 "Summary" for work restrictions and limitations on utility interruptions.

#### 1.2 USE CHARGES

- A. General: Installation and removal of and use charges for temporary facilities shall be included in the Contract Sum unless otherwise indicated. Allow other entities to use temporary services and facilities without cost, including, but not limited to, Owner's construction forces, Architect, occupants of Project, testing agencies, and authorities having jurisdiction.
- B. Water and Sewer Service from Existing System: Water from Owner's existing water system is available for use without metering and without payment of use charges. Provide connections and extensions of services as required for construction operations.
- C. Electric Power Service from Existing System: Electric power from Owner's existing system is available for use without metering and without payment of use charges. Provide connections and extensions of services as required for construction operations.

#### 1.3 INFORMATIONAL SUBMITTALS

- A. Site Plan: Show temporary facilities, utility hookups, staging areas, and parking areas for construction personnel.
- B. Fire-Safety Program: Show compliance with requirements of NFPA 241 and authorities having jurisdiction. Indicate Contractor personnel responsible for management of fire prevention program.

#### 1.4 QUALITY ASSURANCE

- A. Electric Service: Comply with NECA, NEMA, and UL standards and regulations for temporary electric service. Install service to comply with NFPA 70.

- B. Tests and Inspections: Arrange for authorities having jurisdiction to test and inspect each temporary utility before use. Obtain required certifications and permits.
- C. Accessible Temporary Egress: Comply with applicable provisions in the U.S. Architectural & Transportation Barriers Compliance Board's ADA-ABA Accessibility Guidelines.

## 1.5 PROJECT CONDITIONS

- A. Temporary Use of Permanent Facilities: Engage Installer of each permanent service to assume responsibility for operation, maintenance, and protection of each permanent service during its use as a construction facility before Owner's acceptance, regardless of previously assigned responsibilities.

## PART 2 - PRODUCTS

### 2.1 TEMPORARY FACILITIES

- A. Storage and Fabrication Sheds: Provide sheds sized, furnished, and equipped to accommodate materials and equipment for construction operations.

### 2.2 EQUIPMENT

- A. Fire Extinguishers: Portable, UL rated; with class and extinguishing agent as required by locations and classes of fire exposures.

## PART 3 - EXECUTION

### 3.1 INSTALLATION, GENERAL

- A. Locate facilities where they will serve Project adequately and result in minimum interference with performance of the Work. Relocate and modify facilities as required by progress of the Work.
  - 1. Locate facilities to limit site disturbance as specified in Section 011000 "Summary."
- B. Provide each facility ready for use when needed to avoid delay. Do not remove until facilities are no longer needed or are replaced by authorized use of completed permanent facilities.

### 3.2 TEMPORARY UTILITY INSTALLATION

- A. General: Install temporary service or connect to existing service.
  - 1. Arrange with utility company, Owner, and existing users for time when service can be interrupted, if necessary, to make connections for temporary services.

- B. Sewers and Drainage: Provide temporary utilities to remove effluent lawfully.
  - 1. Connect temporary sewers to municipal system as directed by authorities having jurisdiction.
- C. Water Service: Install water service and distribution piping in sizes and pressures adequate for construction.
- D. Sanitary Facilities: Provide temporary toilets, wash facilities, and drinking water for use of construction personnel. Comply with requirements of authorities having jurisdiction for type, number, location, operation, and maintenance of fixtures and facilities.
  - 1. Toilets: Use of Owner's existing toilet facilities will be permitted, as long as facilities are cleaned and maintained in a condition acceptable to Owner. At Substantial Completion, restore these facilities to condition existing before initial use.
- E. Heating and Cooling: Provide temporary heating and cooling required by construction activities for curing or drying of completed installations or for protecting installed construction from adverse effects of low temperatures or high humidity. Select equipment that will not have a harmful effect on completed installations or elements being installed.
- F. Ventilation and Humidity Control: Provide temporary ventilation required by construction activities for curing or drying of completed installations or for protecting installed construction from adverse effects of high humidity. Select equipment that will not have a harmful effect on completed installations or elements being installed. Coordinate ventilation requirements to produce ambient condition required and minimize energy consumption.
- G. Electric Power Service: Provide electric power service and distribution system of sufficient size, capacity, and power characteristics required for construction operations.
  - 1. Install electric power service overhead unless otherwise indicated.
  - 2. Connect temporary service to Owner's existing power source, as directed by Owner.
- H. Lighting: Provide temporary lighting with local switching that provides adequate illumination for construction operations, observations, inspections, and traffic conditions.
  - 1. Install and operate temporary lighting that fulfills security and protection requirements without operating entire system.

### 3.3 SUPPORT FACILITIES INSTALLATION

- A. General: Comply with the following:
1. Provide construction for temporary offices, shops, and sheds located within construction area or within 30 feet of building lines that is noncombustible according to ASTM E 136. Comply with NFPA 241.
  2. Maintain support facilities until Architect schedules Substantial Completion inspection. Remove before Substantial Completion. Personnel remaining after Substantial Completion will be permitted to use permanent facilities, under conditions acceptable to Owner.
- B. Traffic Controls: Comply with requirements of authorities having jurisdiction.
1. Protect existing site improvements to remain including curbs, pavement, and utilities.
  2. Maintain access for fire-fighting equipment and access to fire hydrants.
- C. Parking: Use designated area of Owner's existing parking areas for contractor's project superintendent.
- D. Project Signs: Provide Project signs as indicated. Unauthorized signs are not permitted.
1. Identification Signs: Provide Project identification signs as indicated on Drawings.
  2. Temporary Signs: Provide other signs as indicated and as required to inform public and individuals seeking entrance to Project.
    - a. Provide temporary, directional signs for construction personnel and visitors.
  3. Maintain and touchup signs so they are legible at all times.
- E. Waste Disposal Facilities: Comply with requirements specified in Section 017419 "Construction Waste Management and Disposal."
- F. Lifts and Hoists: Provide facilities necessary for hoisting materials and personnel.
1. Truck cranes and similar devices used for hoisting materials are considered "tools and equipment" and not temporary facilities.
- G. Existing Elevator Use: Use of Owner's existing elevators will be permitted, provided elevators are cleaned and maintained in a condition acceptable to Owner. At Substantial Completion, restore elevators to condition existing before initial use, including replacing worn cables, guide shoes, and similar items of limited life.
1. Do not load elevators beyond their rated weight capacity.
  2. Provide protective coverings, barriers, devices, signs, or other procedures to protect elevator car and entrance doors and frame. If, despite such protection, elevators become damaged, engage elevator Installer to restore damaged work so no evidence remains of correction work. Return items that cannot be refinished in field to the shop, make required repairs and refinish entire unit, or provide new units as required.

- H. Existing Stair Usage: Use of Owner's existing stairs will be permitted, provided stairs are cleaned and maintained in a condition acceptable to Owner. At Substantial Completion, restore stairs to condition existing before initial use.
  - 1. Provide protective coverings, barriers, devices, signs, or other procedures to protect stairs and to maintain means of egress. If stairs become damaged, restore damaged areas so no evidence remains of correction work.

### 3.4 SECURITY AND PROTECTION FACILITIES INSTALLATION

- A. Protection of Existing Facilities: Protect existing vegetation, equipment, structures, utilities, and other improvements at Project site and on adjacent properties, except those indicated to be removed or altered. Repair damage to existing facilities.
- B. Environmental Protection: Provide protection, operate temporary facilities, and conduct construction as required to comply with environmental regulations and that minimize possible air, waterway, and subsoil contamination or pollution or other undesirable effects.
- C. Barricades, Warning Signs, and Lights: Comply with requirements of authorities having jurisdiction for erecting structurally adequate barricades, including warning signs and lighting.
- D. Temporary Egress: Maintain temporary egress from existing occupied facilities as indicated and as required by authorities having jurisdiction.
- E. Temporary Partitions: Provide floor-to-ceiling dustproof partitions to limit dust and dirt migration and to separate areas occupied by Owner from fumes and noise.
  - 1. Construct dustproof partitions with gypsum wallboard with joints taped on occupied side, and fire-retardant-treated plywood on construction operations side.
  - 2. Where fire-resistance-rated temporary partitions are indicated or are required by authorities having jurisdiction, construct partitions according to the rated assemblies.
  - 3. Insulate partitions to control noise transmission to occupied areas.
  - 4. Seal joints and perimeter. Equip partitions with gasketed dustproof doors and security locks where openings are required.
  - 5. Protect air-handling equipment.
  - 6. Provide walk-off mats at each entrance through temporary partition.
- F. Temporary Fire Protection: Install and maintain temporary fire-protection facilities of types needed to protect against reasonably predictable and controllable fire losses. Comply with NFPA 241; manage fire prevention program.
  - 1. Prohibit smoking in construction areas.
  - 2. Supervise welding operations, combustion-type temporary heating units, and similar sources of fire ignition according to requirements of authorities having jurisdiction.
  - 3. Develop and supervise an overall fire-prevention and -protection program for personnel at Project site. Review needs with local fire department and establish procedures to be

followed. Instruct personnel in methods and procedures. Post warnings and information.

4. Provide temporary standpipes and hoses for fire protection. Hang hoses with a warning sign stating that hoses are for fire-protection purposes only and are not to be removed.  
Match hose size with outlet size and equip with suitable nozzles.

### 3.5 MOISTURE AND MOLD CONTROL

- A. Contractor's Moisture Protection Plan: Avoid trapping water in finished work. Document visible signs of mold that may appear during construction.
- B. Controlled Construction Phase of Construction: After completing and sealing of the building enclosure but prior to the full operation of permanent HVAC systems, maintain as follows:
  1. Control moisture and humidity inside building by maintaining effective dry-in conditions.
  2. Remove materials that cannot be completely restored to their manufactured moisture level within 48 hours.

### 3.6 OPERATION, TERMINATION, AND REMOVAL

- A. Supervision: Enforce strict discipline in use of temporary facilities. To minimize waste and abuse, limit availability of temporary facilities to essential and intended uses.
- B. Maintenance: Maintain facilities in good operating condition until removal.
  1. Maintain operation of temporary enclosures, heating, cooling, humidity control, ventilation, and similar facilities on a 24-hour basis where required to achieve indicated results and to avoid possibility of damage.
- C. Temporary Facility Changeover: Do not change over from using temporary security and protection facilities to permanent facilities until Substantial Completion.
- D. Termination and Removal: Remove each temporary facility when need for its service has ended, when it has been replaced by authorized use of a permanent facility, or no later than Substantial Completion. Complete or, if necessary, restore permanent construction that may have been delayed because of interference with temporary facility. Repair damaged Work, clean exposed surfaces, and replace construction that cannot be satisfactorily repaired.
  1. Materials and facilities that constitute temporary facilities are property of Contractor. Owner reserves right to take possession of Project identification signs.
  2. At Substantial Completion, repair, renovate, and clean permanent facilities used during construction period. Comply with final cleaning requirements specified in Section 017700 "Closeout Procedures."

END OF SECTION 015000

## SECTION 016000 - PRODUCT REQUIREMENTS

### PART 1 - GENERAL

#### 1.1 SUMMARY

- A. Section includes administrative and procedural requirements for selection of products for use in Project; product delivery, storage, and handling; manufacturers' standard warranties on products; special warranties; and comparable products.
- B. Related Requirements:
  - 1. Section 012500 "Substitution Procedures" for requests for substitutions.

#### 1.2 DEFINITIONS

- A. Products: Items obtained for incorporating into the Work, whether purchased for Project or taken from previously purchased stock. The term "product" includes the terms "material," "equipment," "system," and terms of similar intent.
  - 1. Named Products: Items identified by manufacturer's product name, including make or model number or other designation shown or listed in manufacturer's published product literature, that is current as of date of the Contract Documents.
  - 2. New Products: Items that have not previously been incorporated into another project or facility. Products salvaged or recycled from other projects are not considered new products.
  - 3. Comparable Product: Product that is demonstrated and approved through submittal process to have the indicated qualities related to type, function, dimension, in-service performance, physical properties, appearance, and other characteristics that equal or exceed those of specified product.
- B. Basis-of-Design Product Specification: A specification in which a specific manufacturer's product is named and accompanied by the words "basis-of-design product," including make or model number or other designation, to establish the significant qualities related to type, function, dimension, in-service performance, physical properties, appearance, and other characteristics for purposes of evaluating comparable products of additional manufacturers named in the specification.

#### 1.3 ACTION SUBMITTALS

- A. Comparable Product Requests: Submit request for consideration of each comparable product. Identify product or fabrication or installation method to be replaced. Include Specification Section number and title and Drawing numbers and titles.

1. Architect's Action: If necessary, Architect will request additional information or documentation for evaluation within one week of receipt of a comparable product request. Architect will notify Contractor through Construction Manager of approval or rejection of proposed comparable product request within 15 days of receipt of request, or seven days of receipt of additional information or documentation, whichever is later.
  - a. Form of Approval: As specified in Section 013300 "Submittal Procedures."
  - b. Use product specified if Architect does not issue a decision on use of a comparable product request within time allocated.

- B. Basis-of-Design Product Specification Submittal: Comply with requirements in Section 013300 "Submittal Procedures." Show compliance with requirements.

#### 1.4 QUALITY ASSURANCE

- A. Compatibility of Options: If Contractor is given option of selecting between two or more products for use on Project, select product compatible with products previously selected, even if previously selected products were also options.

#### 1.5 PRODUCT DELIVERY, STORAGE, AND HANDLING

- A. Deliver, store, and handle products using means and methods that will prevent damage, deterioration, and loss, including theft and vandalism. Comply with manufacturer's written instructions.

- B. Delivery and Handling:

1. Schedule delivery to minimize long-term storage at Project site and to prevent overcrowding of construction spaces.
2. Coordinate delivery with installation time to ensure minimum holding time for items that are flammable, hazardous, easily damaged, or sensitive to deterioration, theft, and other losses.
3. Deliver products to Project site in an undamaged condition in manufacturer's original sealed container or other packaging system, complete with labels and instructions for handling, storing, unpacking, protecting, and installing.
4. Inspect products on delivery to determine compliance with the Contract Documents and to determine that products are undamaged and properly protected.

- C. Storage:

1. Store products to allow for inspection and measurement of quantity or counting of units.
2. Store materials in a manner that will not endanger Project structure.
3. Store products that are subject to damage by the elements, under cover in a weathertight enclosure above ground, with ventilation adequate to prevent condensation.
4. Protect foam plastic from exposure to sunlight, except to extent necessary for period of installation and concealment.



5. Comply with product manufacturer's written instructions for temperature, humidity, ventilation, and weather-protection requirements for storage.
6. Protect stored products from damage and liquids from freezing.

## 1.6 PRODUCT WARRANTIES

- A. Warranties specified in other Sections shall be in addition to, and run concurrent with, other warranties required by the Contract Documents. Manufacturer's disclaimers and limitations on product warranties do not relieve Contractor of obligations under requirements of the Contract Documents.
  1. Manufacturer's Warranty: Written warranty furnished by individual manufacturer for a particular product and specifically endorsed by manufacturer to Owner.
  2. Special Warranty: Written warranty required by the Contract Documents to provide specific rights for Owner.
- B. Special Warranties: Prepare a written document that contains appropriate terms and identification, ready for execution.
  1. Manufacturer's Standard Form: Modified to include Project-specific information and properly executed.
  2. Specified Form: When specified forms are included with the Specifications, prepare a written document using indicated form properly executed.
  3. Refer to other Sections for specific content requirements and particular requirements for submitting special warranties.
- C. Submittal Time: Comply with requirements in Section 017700 "Closeout Procedures."

## PART 2 - PRODUCTS

### 2.1 PRODUCT SELECTION PROCEDURES

- A. General Product Requirements: Provide products that comply with the Contract Documents, are undamaged and, unless otherwise indicated, are new at time of installation.
  1. Provide products complete with accessories, trim, finish, fasteners, and other items needed for a complete installation and indicated use and effect.
  2. Standard Products: If available, and unless custom products or nonstandard options are specified, provide standard products of types that have been produced and used successfully in similar situations on other projects.
  3. Owner reserves the right to limit selection to products with warranties not in conflict with requirements of the Contract Documents.
  4. Where products are accompanied by the term "as selected," Architect will make selection.
  5. Descriptive, performance, and reference standard requirements in the Specifications establish salient characteristics of products.

**B. Product Selection Procedures:**

1. **Product:** Where Specifications name a single manufacturer and product, provide the named product that complies with requirements. Comparable products or substitutions for Contractor's convenience will not be considered.
2. **Manufacturer/Source:** Where Specifications name a single manufacturer or source, provide a product by the named manufacturer or source that complies with requirements. Comparable products or substitutions for Contractor's convenience will not be considered.
3. **Products:**
  - a. **Restricted List:** Where Specifications include a list of names of both manufacturers and products, provide one of the products listed that complies with requirements. Comparable products or substitutions for Contractor's convenience will not be considered unless otherwise indicated.
  - b. **Nonrestricted List:** Where Specifications include a list of names of both available manufacturers and products, provide one of the products listed, or an unnamed product, that complies with requirements. Comply with requirements in "Comparable Products" Article for consideration of an unnamed product.
4. **Manufacturers:**
  - a. **Restricted List:** Where Specifications include a list of manufacturers' names, provide a product by one of the manufacturers listed that complies with requirements. Comparable products or substitutions for Contractor's convenience will not be considered unless otherwise indicated.
  - b. **Nonrestricted List:** Where Specifications include a list of available manufacturers, provide a product by one of the manufacturers listed, or a product by an unnamed manufacturer, that complies with requirements. Comply with requirements in "Comparable Products" Article for consideration of an unnamed manufacturer's product.
5. **Basis-of-Design Product:** Where Specifications name a product, or refer to a product indicated on Drawings, and include a list of manufacturers, provide the specified or indicated product or a comparable product by one of the other named manufacturers. Drawings and Specifications indicate sizes, profiles, dimensions, and other characteristics that are based on the product named. Comply with requirements in "Comparable Products" Article for consideration of an unnamed product by one of the other named manufacturers.

**C. Visual Matching Specification:** Where Specifications require "match Architect's sample", provide a product that complies with requirements and matches Architect's sample. Architect's decision will be final on whether a proposed product matches.

1. If no product available within specified category matches and complies with other specified requirements, comply with requirements in Section 012500 "Substitution Procedures" for proposal of product.

- D. Visual Selection Specification: Where Specifications include the phrase "as selected by Architect from manufacturer's full range" or similar phrase, select a product that complies with requirements. Architect will select color, gloss, pattern, density, or texture from manufacturer's product line that includes both standard and premium items.

## 2.2 COMPARABLE PRODUCTS

- A. Conditions for Consideration: Architect will consider Contractor's request for comparable product when the following conditions are satisfied. If the following conditions are not satisfied, Architect may return requests without action, except to record noncompliance with these requirements:
1. Evidence that the proposed product does not require revisions to the Contract Documents, that it is consistent with the Contract Documents and will produce the indicated results, and that it is compatible with other portions of the Work.
  2. Detailed comparison of significant qualities of proposed product with those named in the Specifications. Significant qualities include attributes such as performance, weight, size, durability, visual effect, and specific features and requirements indicated.
  3. Evidence that proposed product provides specified warranty.
  4. List of similar installations for completed projects with project names and addresses and names and addresses of architects and owners, if requested.
  5. Samples, if requested.

PART 3 - EXECUTION (Not Used)

END OF SECTION 016000

Issued for Construction

Verrill Dana Interior Renovations  
Portland, Maine  
Project No. 16001

## SECTION 017300 - EXECUTION

### PART 1 - GENERAL

#### 1.1 SUMMARY

- A. Section includes general administrative and procedural requirements governing execution of the Work including, but not limited to, the following:
  - 1. Installation of the Work.
  - 2. Cutting and patching.
  - 3. Coordination of Owner-installed products.
  - 4. Progress cleaning.
  - 5. Starting and adjusting.
  - 6. Protection of installed construction.
  
- B. Related Requirements:
  - 1. Section 011000 "Summary" for limits on use of Project site.
  - 2. Section 017700 "Closeout Procedures" for submitting final property survey with Project Record Documents, recording of Owner-accepted deviations from indicated lines and levels, and final cleaning.
  - 3. Section 078413 "Penetration Firestopping" for patching penetrations in fire-rated construction.

#### 1.2 INFORMATIONAL SUBMITTALS

- A. Landfill Receipts: Submit copy of receipts issued by a landfill facility, licensed to accept hazardous materials, for hazardous waste disposal.

#### 1.3 QUALITY ASSURANCE

- A. Cutting and Patching: Comply with requirements for and limitations on cutting and patching of construction elements.
  - 1. Structural Elements: When cutting and patching structural elements, notify Architect of locations and details of cutting and await directions from Architect before proceeding. Shore, brace, and support structural element during cutting and patching. Do not cut and patch structural elements in a manner that could change their load-carrying capacity or increase deflection

2. Operational Elements: Do not cut and patch operating elements and related components in a manner that results in reducing their capacity to perform as intended or that results in increased maintenance or decreased operational life or safety.
3. Other Construction Elements: Do not cut and patch other construction elements or components in a manner that could change their load-carrying capacity, that results in reducing their capacity to perform as intended, or that results in increased maintenance or decreased operational life or safety.
4. Visual Elements: Do not cut and patch construction in a manner that results in visual evidence of cutting and patching. Do not cut and patch exposed construction in a manner that would, in Architect's opinion, reduce the building's aesthetic qualities. Remove and replace construction that has been cut and patched in a visually unsatisfactory manner.

## PART 2 - PRODUCTS

### 2.1 MATERIALS

- A. General: Comply with requirements specified in other Sections.
- B. In-Place Materials: Use materials for patching identical to in-place materials. For exposed surfaces, use materials that visually match in-place adjacent surfaces to the fullest extent possible.
  1. If identical materials are unavailable or cannot be used, use materials that, when installed, will provide a match acceptable to Architect for the visual and functional performance of in-place materials.

## PART 3 - EXECUTION

### 3.1 EXAMINATION

- A. Examination and Acceptance of Conditions: Before proceeding with each component of the Work, examine substrates, areas, and conditions, with Installer or Applicator present where indicated, for compliance with requirements for installation tolerances and other conditions affecting performance. Record observations.
  1. Examine roughing-in for mechanical and electrical systems to verify actual locations of connections before equipment and fixture installation.
  2. Examine walls, floors, and roofs for suitable conditions where products and systems are to be installed.
  3. Verify compatibility with and suitability of substrates, including compatibility with existing finishes or primers.
- B. Proceed with installation only after unsatisfactory conditions have been corrected. Proceeding with the Work indicates acceptance of surfaces and conditions.

### 3.2 PREPARATION

- A. **Field Measurements:** Take field measurements as required to fit the Work properly. Recheck measurements before installing each product. Where portions of the Work are indicated to fit to other construction, verify dimensions of other construction by field measurements before fabrication. Coordinate fabrication schedule with construction progress to avoid delaying the Work.
- B. **Space Requirements:** Verify space requirements and dimensions of items shown diagrammatically on Drawings.
- C. **Review of Contract Documents and Field Conditions:** Immediately on discovery of the need for clarification of the Contract Documents caused by differing field conditions outside the control of Contractor, submit a request for information to Architect according to requirements in Section 013100 "Project Management and Coordination."

### 3.3 INSTALLATION

- A. **General:** Locate the Work and components of the Work accurately, in correct alignment and elevation, as indicated.
  - 1. Make vertical work plumb and make horizontal work level.
  - 2. Where space is limited, install components to maximize space available for maintenance and ease of removal for replacement.
  - 3. Conceal pipes, ducts, and wiring in finished areas unless otherwise indicated.
- B. Comply with manufacturer's written instructions and recommendations for installing products in applications indicated.
- C. Install products at the time and under conditions that will ensure the best possible results. Maintain conditions required for product performance until Substantial Completion.
- D. Conduct construction operations so no part of the Work is subjected to damaging operations or loading in excess of that expected during normal conditions of occupancy.
- E. Sequence the Work and allow adequate clearances to accommodate movement of construction items on site and placement in permanent locations.
- F. **Tools and Equipment:** Do not use tools or equipment that produce harmful noise levels.
- G. **Templates:** Obtain and distribute to the parties involved templates for work specified to be factory prepared and field installed. Check Shop Drawings of other work to confirm that adequate provisions are made for locating and installing products to comply with indicated requirements.
- H. **Attachment:** Provide blocking and attachment plates and anchors and fasteners of adequate size and number to securely anchor each component in place, accurately located and aligned with other portions of the Work. Where size and type of attachments are not indicated, verify size and type required for load conditions.

1. Mounting Heights: Where mounting heights are not indicated, mount components at heights directed by Architect.
  2. Allow for building movement, including thermal expansion and contraction.
  3. Coordinate installation of anchorages. Furnish setting drawings, templates, and directions for installing anchorages, including sleeves, concrete inserts, anchor bolts, and items with integral anchors, that are to be embedded in concrete or masonry. Deliver such items to Project site in time for installation.
- I. Joints: Make joints of uniform width. Where joint locations in exposed work are not indicated, arrange joints for the best visual effect. Fit exposed connections together to form hairline joints.
- J. Hazardous Materials: Use products, cleaners, and installation materials that are not considered hazardous.

### 3.4 CUTTING AND PATCHING

- A. Cutting and Patching, General: Employ skilled workers to perform cutting and patching. Proceed with cutting and patching at the earliest feasible time, and complete without delay.
1. Cut in-place construction to provide for installation of other components or performance of other construction, and subsequently patch as required to restore surfaces to their original condition.
- B. Existing Warranties: Remove, replace, patch, and repair materials and surfaces cut or damaged during installation or cutting and patching operations, by methods and with materials so as not to void existing warranties.
- C. Temporary Support: Provide temporary support of work to be cut.
- D. Protection: Protect in-place construction during cutting and patching to prevent damage. Provide protection from adverse weather conditions for portions of Project that might be exposed during cutting and patching operations.
- E. Adjacent Occupied Areas: Avoid interference with use of adjoining areas or interruption of free passage to adjoining areas.
- F. Existing Utility Services and Mechanical/Electrical Systems: Where existing services/systems are required to be removed, relocated, or abandoned, bypass such services/systems before cutting to minimize interruption to occupied areas.
- G. Cutting: Cut in-place construction by sawing, drilling, breaking, chipping, grinding, and similar operations, including excavation, using methods least likely to damage elements retained or adjoining construction. If possible, review proposed procedures with original Installer; comply with original Installer's written recommendations.
1. In general, use hand or small power tools designed for sawing and grinding, not hammering and chopping. Cut holes and slots neatly to minimum size required, and with minimum disturbance of adjacent surfaces. Temporarily cover openings when not in use.



2. Finished Surfaces: Cut or drill from the exposed or finished side into concealed surfaces.
3. Concrete and Masonry: Cut using a cutting machine, such as an abrasive saw or a diamond-core drill.
4. Mechanical and Electrical Services: Cut off pipe or conduit in walls or partitions to be removed. Cap, valve, or plug and seal remaining portion of pipe or conduit to prevent entrance of moisture or other foreign matter after cutting.
5. Proceed with patching after construction operations requiring cutting are complete.

H. Patching: Patch construction by filling, repairing, refinishing, closing up, and similar operations following performance of other work. Patch with durable seams that are as invisible as practicable. Provide materials and comply with installation requirements specified in other Sections, where applicable.

1. Inspection: Where feasible, test and inspect patched areas after completion to demonstrate physical integrity of installation.
2. Exposed Finishes: Restore exposed finishes of patched areas and extend finish restoration into retained adjoining construction in a manner that will minimize evidence of patching and refinishing.
3. Floors and Walls: Where walls or partitions that are removed extend one finished area into another, patch and repair floor and wall surfaces in the new space. Provide an even surface of uniform finish, color, texture, and appearance. Remove in-place floor and wall coverings and replace with new materials, if necessary, to achieve uniform color and appearance.
4. Ceilings: Patch, repair, or rehang in-place ceilings as necessary to provide an even-plane surface of uniform appearance.
5. Exterior Building Enclosure: Patch components in a manner that restores enclosure to a weathertight condition and ensures thermal and moisture integrity of building enclosure.

I. Cleaning: Clean areas and spaces where cutting and patching are performed. Remove paint, mortar, oils, putty, and similar materials from adjacent finished surfaces.

### 3.5 PROGRESS CLEANING

- A. General: Clean Project site and work areas daily, including common areas. Enforce requirements strictly. Dispose of materials lawfully.
1. Comply with requirements in NFPA 241 for removal of combustible waste materials and debris.
  2. Do not hold waste materials more than seven days during normal weather or three days if the temperature is expected to rise above 80 deg F.
  3. Containerize hazardous and unsanitary waste materials separately from other waste. Mark containers appropriately and dispose of legally, according to regulations.
- B. Site: Maintain Project site free of waste materials and debris.
- C. Work Areas: Clean areas where work is in progress to the level of cleanliness necessary for proper execution of the Work.
1. Remove liquid spills promptly.

2. Where dust would impair proper execution of the Work, broom-clean or vacuum the entire work area, as appropriate.
- D. Installed Work: Keep installed work clean. Clean installed surfaces according to written instructions of manufacturer or fabricator of product installed, using only cleaning materials specifically recommended. If specific cleaning materials are not recommended, use cleaning materials that are not hazardous to health or property and that will not damage exposed surfaces.
- E. Concealed Spaces: Remove debris from concealed spaces before enclosing the space.
- F. Exposed Surfaces in Finished Areas: Clean exposed surfaces and protect as necessary to ensure freedom from damage and deterioration at time of Substantial Completion.
- G. Waste Disposal: Do not bury or burn waste materials on-site. Do not wash waste materials down sewers or into waterways.
- H. During handling and installation, clean and protect construction in progress and adjoining materials already in place. Apply protective covering where required to ensure protection from damage or deterioration at Substantial Completion.
- I. Clean and provide maintenance on completed construction as frequently as necessary through the remainder of the construction period. Adjust and lubricate operable components to ensure operability without damaging effects.
- J. Limiting Exposures: Supervise construction operations to assure that no part of the construction, completed or in progress, is subject to harmful, dangerous, damaging, or otherwise deleterious exposure during the construction period.

### 3.6 STARTING AND ADJUSTING

- A. Start equipment and operating components to confirm proper operation. Remove malfunctioning units, replace with new units, and retest.
- B. Adjust equipment for proper operation. Adjust operating components for proper operation without binding.
- C. Test each piece of equipment to verify proper operation. Test and adjust controls and safeties. Replace damaged and malfunctioning controls and equipment.
- D. Manufacturer's Field Service: Comply with qualification requirements in Section 014000 "Quality Requirements"

### 3.7 PROTECTION OF INSTALLED CONSTRUCTION

- A. Provide final protection and maintain conditions that ensure installed Work is without damage or deterioration at time of Substantial Completion.
- B. Comply with manufacturer's written instructions for temperature and relative humidity.

Issued for Construction

Verrill Dana Interior Renovations  
Portland, Maine  
Project No. 16001

END OF SECTION 017300

Issued for Construction

Verrill Dana Interior Renovations  
Portland, Maine  
Project No. 16001

## SECTION 017419 - CONSTRUCTION WASTE MANAGEMENT AND DISPOSAL

### PART 1 - GENERAL

#### 1.1 SUMMARY

- A. Section includes administrative and procedural requirements for the following:
  - 1. Salvaging nonhazardous demolition and construction waste.
  - 2. Recycling nonhazardous demolition and construction waste.
  - 3. Disposing of nonhazardous demolition and construction waste.
- B. Related Requirements:
  - 1. Section 024119 "Selective Demolition" for disposition of waste resulting from partial demolition of buildings, structures, and site improvements, and for disposition of hazardous waste.

#### 1.2 DEFINITIONS

- A. Construction Waste: Building and site improvement materials and other solid waste resulting from construction, remodeling, renovation, or repair operations. Construction waste includes packaging.
- B. Demolition Waste: Building and site improvement materials resulting from demolition or selective demolition operations.
- C. Disposal: Removal off-site of demolition and construction waste and subsequent sale, recycling, reuse, or deposit in landfill or incinerator acceptable to authorities having jurisdiction.
- D. Recycle: Recovery of demolition or construction waste for subsequent processing in preparation for reuse.
- E. Salvage: Recovery of demolition or construction waste and subsequent sale or reuse in another facility.
- F. Salvage and Reuse: Recovery of demolition or construction waste and subsequent incorporation into the Work.

#### 1.3 ACTION SUBMITTALS

- A. Waste Management Plan: Submit plan within 30 days of date established for commencement of the Work.

#### 1.4 INFORMATIONAL SUBMITTALS

- A. Waste Reduction Progress Reports: Concurrent with each Application for Payment, submit report. Include the following information:
  - 1. Material category.
  - 2. Generation point of waste.
  - 3. Total quantity of waste in tons.
  - 4. Quantity of waste salvaged, both estimated and actual in tons.
  - 5. Quantity of waste recycled, both estimated and actual in tons.
  - 6. Total quantity of waste recovered (salvaged plus recycled) in tons.
  - 7. Total quantity of waste recovered (salvaged plus recycled) as a percentage of total waste.
- B. Waste Reduction Calculations: Before request for Substantial Completion, submit calculated end-of-Project rates for salvage, recycling, and disposal as a percentage of total waste generated by the Work.
- C. Records of Donations: Indicate receipt and acceptance of salvageable waste donated to individuals and organizations. Indicate whether organization is tax exempt.
- D. Records of Sales: Indicate receipt and acceptance of salvageable waste sold to individuals and organizations. Indicate whether organization is tax exempt.
- E. Recycling and Processing Facility Records: Indicate receipt and acceptance of recyclable waste by recycling and processing facilities licensed to accept them. Include manifests, weight tickets, receipts, and invoices.
- F. Landfill and Incinerator Disposal Records: Indicate receipt and acceptance of waste by landfills and incinerator facilities licensed to accept them. Include manifests, weight tickets, receipts, and invoices.

#### 1.5 QUALITY ASSURANCE

- A. Waste Management Coordinator Qualifications: LEED-Accredited Professional, certified by USGBC.
- B. Waste Management Conference: Conduct conference at Project site to comply with requirements in Section 013100 "Project Management and Coordination."

#### 1.6 WASTE MANAGEMENT PLAN

- A. General: Develop a waste management plan according to ASTM E 1609 and requirements in this Section. Plan shall consist of waste identification, waste reduction work plan, and cost/revenue analysis. Distinguish between demolition and construction waste. Indicate quantities by weight or volume, but use same units of measure throughout waste management plan.

- B. Waste Identification: Indicate anticipated types and quantities of demolition and construction waste generated by the Work. Include estimated quantities and assumptions for estimates.
- C. Waste Reduction Work Plan: List each type of waste and whether it will be salvaged, recycled, or disposed of in landfill or incinerator. Include points of waste generation, total quantity of each type of waste, quantity for each means of recovery, and handling and transportation procedures.
  - 1. Salvaged Materials for Reuse: For materials that will be salvaged and reused in this Project, describe methods for preparing salvaged materials before incorporation into the Work.
  - 2. Salvaged Materials for Sale: For materials that will be sold to individuals and organizations, include list of their names, addresses, and telephone numbers.
  - 3. Salvaged Materials for Donation: For materials that will be donated to individuals and organizations, include list of their names, addresses, and telephone numbers.
  - 4. Recycled Materials: Include list of local receivers and processors and type of recycled materials each will accept. Include names, addresses, and telephone numbers.
  - 5. Disposed Materials: Indicate how and where materials will be disposed of. Include name, address, and telephone number of each landfill and incinerator facility.
  - 6. Handling and Transportation Procedures: Include method that will be used for separating recyclable waste including sizes of containers, container labeling, and designated location where materials separation will be performed.

## PART 2 - PRODUCTS (Not Used)

## PART 3 - EXECUTION

### 3.1 PLAN IMPLEMENTATION

- A. General: Implement approved waste management plan. Provide handling, containers, storage, signage, transportation, and other items as required to implement waste management plan during the entire duration of the Contract.
- B. Waste Management Coordinator: Engage a waste management coordinator to be responsible for implementing, monitoring, and reporting status of waste management work plan.
- C. Training: Train workers, subcontractors, and suppliers on proper waste management procedures, as appropriate for the Work occurring at Project site.
  - 1. Distribute waste management plan to everyone concerned within three days of submittal return.
  - 2. Distribute waste management plan to entities when they first begin work on-site. Review plan procedures and locations established for salvage, recycling, and disposal.

- D. Site Access and Temporary Controls: Conduct waste management operations to ensure minimum interference with roads, streets, walks, walkways, and other adjacent occupied and used facilities.
1. Designate and label specific areas on Project site necessary for separating materials that are to be salvaged, recycled, reused, donated, and sold.
  2. Comply with Section 015000 "Temporary Facilities and Controls" for controlling dust and dirt, environmental protection, and noise control.

### 3.2 SALVAGING DEMOLITION WASTE

A. Salvaged Items for Reuse in the Work:

1. Clean salvaged items.
2. Pack or crate items after cleaning. Identify contents of containers.
3. Store items in a secure area until installation.
4. Protect items from damage during transport and storage.
5. Install salvaged items to comply with installation requirements for new materials and equipment. Provide connections, supports, and miscellaneous materials necessary to make items functional for use indicated.

B. Salvaged Items for Sale and Donation: Not permitted on Project site.

C. Salvaged Items for Owner's Use:

1. Clean salvaged items.
2. Pack or crate items after cleaning. Identify contents of containers.
3. Store items in a secure area until delivery to Owner.
4. Transport items to Owner's storage area off-site.
5. Protect items from damage during transport and storage.

### 3.3 RECYCLING DEMOLITION AND CONSTRUCTION WASTE, GENERAL

A. General: Recycle paper and beverage containers used by on-site workers.

B. Recycling Incentives: Revenues, savings, rebates, tax credits, and other incentives received for recycling waste materials shall be shared equally by Owner and Contractor.

C. Procedures: Separate recyclable waste from other waste materials, trash, and debris. Separate recyclable waste by type at Project site to the maximum extent practical according to approved construction waste management plan.

1. Provide appropriately marked containers or bins for controlling recyclable waste until they are removed from Project site. Include list of acceptable and unacceptable materials at each container and bin.



- a. Inspect containers and bins for contamination and remove contaminated materials if found.
2. Stockpile processed materials on-site without intermixing with other materials. Place, grade, and shape stockpiles to drain surface water. Cover to prevent windblown dust.
3. Stockpile materials away from construction area. Do not store within drip line of remaining trees.
4. Store components off the ground and protect from the weather.
5. Remove recyclable waste from Owner's property and transport to recycling receiver or processor.

### 3.4 RECYCLING DEMOLITION WASTE

- A. Concrete: Remove reinforcement and other metals from concrete and sort with other metals.
  1. Pulverize concrete to maximum 1-1/2-inch size.
- B. Masonry: Remove metal reinforcement, anchors, and ties from masonry and sort with other metals.
  1. Pulverize masonry to maximum 3/4-inch size.
  2. Clean and stack undamaged, whole masonry units on wood pallets.
- C. Wood Materials: Sort and stack members according to size, type, and length. Separate lumber, engineered wood products, panel products, and treated wood materials.
- D. Metals: Separate metals by type.
  1. Structural Steel: Stack members according to size, type of member, and length.
  2. Remove and dispose of bolts, nuts, washers, and other rough hardware.
- E. Gypsum Board: Stack large clean pieces on wood pallets or in container and store in a dry location. Remove edge trim and sort with other metals. Remove and dispose of fasteners.
- F. Acoustical Ceiling Panels and Tile: Stack large clean pieces on wood pallets and store in a dry location.
- G. Metal Suspension System: Separate metal members including trim, and other metals from acoustical panels and tile and sort with other metals.
- H. Carpet and Pad: Roll large pieces tightly after removing debris, trash, adhesive, and tack strips.
  1. Store clean, dry carpet and pad in a closed container or trailer provided by Carpet Reclamation Agency or carpet recycler.

- I. Carpet Tile: Remove debris, trash, and adhesive.
  - 1. Stack tile on pallet and store clean, dry carpet in a closed container or trailer provided by Carpet Reclamation Agency or carpet recycler.
- J. Piping: Reduce piping to straight lengths and store by type and size. Separate supports, hangers, valves, sprinklers, and other components by type and size.
- K. Conduit: Reduce conduit to straight lengths and store by type and size.

### 3.5 RECYCLING CONSTRUCTION WASTE

- A. Packaging:
  - 1. Cardboard and Boxes: Break down packaging into flat sheets. Bundle and store in a dry location.
  - 2. Polystyrene Packaging: Separate and bag materials.
  - 3. Pallets: As much as possible, require deliveries using pallets to remove pallets from Project site. For pallets that remain on-site, break down pallets into component wood pieces and comply with requirements for recycling wood.
  - 4. Crates: Break down crates into component wood pieces and comply with requirements for recycling wood.
- B. Wood Materials:
  - 1. Clean Cut-Offs of Lumber: Grind or chip into small pieces.
  - 2. Clean Sawdust: Bag sawdust that does not contain painted or treated wood.
- C. Gypsum Board: Stack large clean pieces on wood pallets or in container and store in a dry location.
  - 1. Clean Gypsum Board: Grind scraps of clean gypsum board using small mobile chipper or hammer mill. Screen out paper after grinding.

### 3.6 DISPOSAL OF WASTE

- A. General: Except for items or materials to be salvaged, recycled, or otherwise reused, remove waste materials from Project site and legally dispose of them in a landfill or incinerator acceptable to authorities having jurisdiction.
  - 1. Except as otherwise specified, do not allow waste materials that are to be disposed of accumulate on-site.
  - 2. Remove and transport debris in a manner that will prevent spillage on adjacent surfaces and areas.
- B. Burning: Do not burn waste materials.

- C. Disposal: Remove waste materials from Owner's property and legally dispose of them.

3.7 SAMPLE FORMS

END OF SECTION 017419

Issued for Construction

Verrill Dana Interior Renovations  
Portland, Maine  
Project No. 16001

## SECTION 017700 - CLOSEOUT PROCEDURES

### PART 1 - GENERAL

#### 1.1 SUMMARY

- A. Section includes administrative and procedural requirements for contract closeout, including, but not limited to, the following:
  - 1. Substantial Completion procedures.
  - 2. Final completion procedures.
  - 3. Warranties.
  - 4. Final cleaning.
  - 5. Repair of the Work.
- B. Related Requirements:
  - 1. Section 017823 "Operation and Maintenance Data" for operation and maintenance manual requirements.
  - 2. Section 017839 "Project Record Documents" for submitting record Drawings, record Specifications, and record Product Data.
  - 3. Section 017900 "Demonstration and Training" for requirements for instructing Owner's personnel.

#### 1.2 ACTION SUBMITTALS

- A. Product Data: For cleaning agents.
- B. Contractor's List of Incomplete Items: Initial submittal at Substantial Completion.
- C. Certified List of Incomplete Items: Final submittal at Final Completion.

#### 1.3 CLOSEOUT SUBMITTALS

- A. Certificates of Release: From authorities having jurisdiction.
- B. Certificate of Insurance: For continuing coverage.
- C. Field Report: For pest control inspection.

#### 1.4 MAINTENANCE MATERIAL SUBMITTALS

- A. Schedule of Maintenance Material Items: For maintenance material submittal items specified in other Sections.

## 1.5 SUBSTANTIAL COMPLETION PROCEDURES

- A. Contractor's List of Incomplete Items: Prepare and submit a list of items to be completed and corrected (Contractor's punch list), indicating the value of each item on the list and reasons why the Work is incomplete.
- B. Submittals Prior to Substantial Completion: Complete the following a minimum of 10 days prior to requesting inspection for determining date of Substantial Completion. List items below that are incomplete at time of request.
1. Certificates of Release: Obtain and submit releases from authorities having jurisdiction permitting Owner unrestricted use of the Work and access to services and utilities. Include occupancy permits, operating certificates, and similar releases.
  2. Submit closeout submittals specified in other Division 01 Sections, including project record documents, operation and maintenance manuals, final completion construction photographic documentation, damage or settlement surveys, property surveys, and similar final record information.
  3. Submit closeout submittals specified in individual Sections, including specific warranties, workmanship bonds, maintenance service agreements, final certifications, and similar documents.
  4. Submit maintenance material submittals specified in individual Sections, including tools, spare parts, extra materials, and similar items, and deliver to location designated by Construction Manager. Label with manufacturer's name and model number where applicable.
    - a. Schedule of Maintenance Material Items: Prepare and submit schedule of maintenance material submittal items, including name and quantity of each item and name and number of related Specification Section. Obtain Construction Manager's signature for receipt of submittals.
  5. Submit test/adjust/balance records.
  6. Submit changeover information related to Owner's occupancy, use, operation, and maintenance.
- C. Procedures Prior to Substantial Completion: Complete the following a minimum of 10 days prior to requesting inspection for determining date of Substantial Completion. List items below that are incomplete at time of request.
1. Advise Owner of pending insurance changeover requirements.
  2. Make final changeover of permanent locks and deliver keys to Owner. Advise Owner's personnel of changeover in security provisions.
  3. Complete startup and testing of systems and equipment.
  4. Perform preventive maintenance on equipment used prior to Substantial Completion.
  5. Instruct Owner's personnel in operation, adjustment, and maintenance of products, equipment, and systems. Submit demonstration and training video recordings specified in Section 017900 "Demonstration and Training."
  6. Advise Owner of changeover in heat and other utilities.

7. Participate with Owner in conducting inspection and walkthrough with local emergency responders.
  8. Terminate and remove temporary facilities from Project site, along with mockups, construction tools, and similar elements.
  9. Complete final cleaning requirements, including touchup painting.
  10. Touch up and otherwise repair and restore marred exposed finishes to eliminate visual defects.
- D. Inspection: Submit a written request for inspection to determine Substantial Completion a minimum of 10 days prior to date the work will be completed and ready for final inspection and tests. On receipt of request, Architect and Construction Manager will either proceed with inspection or notify Contractor of unfulfilled requirements. Architect will prepare the Certificate of Substantial Completion after inspection or will notify Contractor of items, either on Contractor's list or additional items identified by Architect, that must be completed or corrected before certificate will be issued.
1. Reinspection: Request reinspection when the Work identified in previous inspections as incomplete is completed or corrected.
  2. Results of completed inspection will form the basis of requirements for final completion.

## 1.6 FINAL COMPLETION PROCEDURES

- A. Preliminary Procedures: Before requesting final inspection for determining final completion, complete the following:
1. Submit a final Application for Payment according to Section 012900 "Payment Procedures."
  2. Certified List of Incomplete Items: Submit certified copy of Architect's Substantial Completion inspection list of items to be completed or corrected (punch list), endorsed and dated by Architect. Certified copy of the list shall state that each item has been completed or otherwise resolved for acceptance.
  3. Certificate of Insurance: Submit evidence of final, continuing insurance coverage complying with insurance requirements.
  4. Submit pest-control final inspection report and warranty.
  5. Instruct Owner's personnel in operation, adjustment, and maintenance of products, equipment, and systems. Submit demonstration and training video recordings.
- B. Inspection: Submit a written request for final inspection to determine acceptance. On receipt of request, Architect and Construction Manager will either proceed with inspection or notify Contractor of unfulfilled requirements. Architect will prepare a final Certificate for Payment after inspection or will notify Contractor of construction that must be completed or corrected before certificate will be issued.
1. Reinspection: Request reinspection when the Work identified in previous inspections as incomplete is completed or corrected.

## 1.7 LIST OF INCOMPLETE ITEMS (PUNCH LIST)

- A. Organization of List: Include name and identification of each space and area affected by construction operations for incomplete items and items needing correction including, if necessary, areas disturbed by Contractor that are outside the limits of construction.
  - 1. Organize list of spaces in sequential order, starting with exterior areas first and proceeding from lowest floor to highest floor.
  - 2. Organize items applying to each space by major element, including categories for ceiling, individual walls, floors, equipment, and building systems.
  - 3. Submit list of incomplete items in the following format:
    - a. Three Insert number paper copies unless otherwise indicated. Architect, through Construction Manager, will return two copies.

## 1.8 SUBMITTAL OF PROJECT WARRANTIES

- A. Time of Submittal: Submit written warranties on request of Architect for designated portions of the Work where commencement of warranties other than date of Substantial Completion is indicated, or when delay in submittal of warranties might limit Owner's rights under warranty.
- B. Organize warranty documents into an orderly sequence based on the table of contents of the Project Manual.
  - 1. Bind warranties and bonds in heavy-duty, three-ring, vinyl-covered, loose-leaf binders, thickness as necessary to accommodate contents, and sized to receive 8-1/2-by-11-inch paper.
  - 2. Provide heavy paper dividers with plastic-covered tabs for each separate warranty. Mark tab to identify the product or installation. Provide a typed description of the product or installation, including the name of the product and the name, address, and telephone number of Installer.
  - 3. Identify each binder on the front and spine with the typed or printed title "WARRANTIES," Project name, and name of Contractor.
  - 4. Warranty Electronic File: Scan warranties and bonds and assemble complete warranty and bond submittal package into a single indexed electronic PDF file with links enabling navigation to each item. Provide bookmarked table of contents at beginning of document.
- C. Provide additional copies of each warranty to include in operation and maintenance manuals.

## PART 2 - PRODUCTS

### 2.1 MATERIALS

- A. Cleaning Agents: Use cleaning materials and agents recommended by manufacturer or fabricator of the surface to be cleaned. Do not use cleaning agents that are potentially



hazardous to health or property or that might damage finished surfaces.

## PART 3 - EXECUTION

### 3.1 FINAL CLEANING

- A. General: Perform final cleaning. Conduct cleaning and waste-removal operations to comply with local laws and ordinances and Federal and local environmental and antipollution regulations.
- B. Cleaning: Employ experienced workers or professional cleaners for final cleaning. Clean each surface or unit to condition expected in an average commercial building cleaning and maintenance program. Comply with manufacturer's written instructions.
  - 1. Complete the following cleaning operations before requesting inspection for certification of Substantial Completion for entire Project or for a designated portion of Project:
    - a. Clean Project site, yard, and grounds, in areas disturbed by construction activities, including landscape development areas, of rubbish, waste material, litter, and other foreign substances.
    - b. Sweep paved areas broom clean. Remove petrochemical spills, stains, and other foreign deposits.
    - c. Rake grounds that are neither planted nor paved to a smooth, even-textured surface.
    - d. Remove tools, construction equipment, machinery, and surplus material from Project site.
    - e. Remove snow and ice to provide safe access to building.
    - f. Clean exposed exterior and interior hard-surfaced finishes to a dirt-free condition, free of stains, films, and similar foreign substances. Avoid disturbing natural weathering of exterior surfaces. Restore reflective surfaces to their original condition.
    - g. Remove debris and surface dust from limited access spaces, including roofs, plenums, shafts, trenches, equipment vaults, manholes, attics, and similar spaces.
    - h. Sweep concrete floors broom clean in unoccupied spaces.
    - i. Vacuum carpet and similar soft surfaces, removing debris and excess nap; clean according to manufacturer's recommendations if visible soil or stains remain.
    - j. Clean transparent materials, including mirrors and glass in doors and windows. Remove glazing compounds and other noticeable, vision-obscuring materials. Replace chipped or broken glass and other damaged transparent materials. Polish mirrors and glass, taking care not to scratch surfaces.
    - k. Remove labels that are not permanent.
    - l. Wipe surfaces of mechanical and electrical equipment, elevator equipment, and similar equipment. Remove excess lubrication, paint and mortar droppings, and other foreign substances.
    - m. Clean plumbing fixtures to a sanitary condition, free of stains, including stains resulting from water exposure.

- n. Replace disposable air filters and clean permanent air filters. Clean exposed surfaces of diffusers, registers, and grills.
  - o. Clean light fixtures, lamps, globes, and reflectors to function with full efficiency.
  - p. Leave Project clean and ready for occupancy.
- C. Pest Control: Comply with pest control requirements in Section 015000 "Temporary Facilities and Controls." Prepare written report.

### 3.2 REPAIR OF THE WORK

- A. Complete repair and restoration operations before requesting inspection for determination of Substantial Completion.
- B. Repair or remove and replace defective construction. Repairing includes replacing defective parts, refinishing damaged surfaces, touching up with matching materials, and properly adjusting operating equipment. Where damaged or worn items cannot be repaired or restored, provide replacements. Remove and replace operating components that cannot be repaired. Restore damaged construction and permanent facilities used during construction to specified condition.
- 1. Remove and replace chipped, scratched, and broken glass, reflective surfaces, and other damaged transparent materials.
  - 2. Touch up and otherwise repair and restore marred or exposed finishes and surfaces. Replace finishes and surfaces that already show evidence of repair or restoration.
    - a. Do not paint over "UL" and other required labels and identification, including mechanical and electrical nameplates. Remove paint applied to required labels and identification.
  - 3. Replace parts subject to operating conditions during construction that may impede operation or reduce longevity.
  - 4. Replace burned-out bulbs, bulbs noticeably dimmed by hours of use, and defective and noisy starters in fluorescent and mercury vapor fixtures to comply with requirements for new fixtures.

END OF SECTION 017700

## SECTION 017823 - OPERATION AND MAINTENANCE DATA

### PART 1 - GENERAL

#### 1.1 SUMMARY

- A. Section includes administrative and procedural requirements for preparing operation and maintenance manuals, including the following:
  - 1. Operation and maintenance documentation directory.
  - 2. Emergency manuals.
  - 3. Operation manuals for systems, subsystems, and equipment.
  - 4. Product maintenance manuals.
  - 5. Systems and equipment maintenance manuals.

#### 1.2 CLOSEOUT SUBMITTALS

- A. Manual Content: Operations and maintenance manual content is specified in individual Specification Sections to be reviewed at the time of Section submittals. Submit reviewed manual content formatted and organized as required by this Section.
  - 1. Architect will comment on whether content of operations and maintenance submittals are acceptable.
  - 2. Where applicable, clarify and update reviewed manual content to correspond to revisions and field conditions.
- B. Format: Submit operations and maintenance manuals in the following format:
  - 1. Three paper copies. Include a complete operation and maintenance directory. Enclose title pages and directories in clear plastic sleeves. Architect will return two copies.
- C. Manual Submittal: Submit each manual in final form prior to requesting inspection for Substantial Completion and at least 15 days before commencing demonstration and training. Architect and Commissioning Authority will return copy with comments.
  - 1. Correct or revise each manual to comply with Architect's and Commissioning Authority's comments. Submit copies of each corrected manual within 15 days of receipt of Architect's and Commissioning Authority's comments and prior to commencing demonstration and training.

## PART 2 - PRODUCTS

### 2.1 REQUIREMENTS FOR EMERGENCY, OPERATION, AND MAINTENANCE MANUALS

- A. Directory: Prepare a single, comprehensive directory of emergency, operation, and maintenance data and materials, listing items and their location to facilitate ready access to desired information.
- B. Organization: Unless otherwise indicated, organize each manual into a separate section for each system and subsystem, and a separate section for each piece of equipment not part of a system. Each manual shall contain the following materials, in the order listed:
  - 1. Title page.
  - 2. Table of contents.
  - 3. Manual contents.
- C. Title Page: Include the following information:
  - 1. Subject matter included in manual.
  - 2. Name and address of Project.
  - 3. Name and address of Owner.
  - 4. Date of submittal.
  - 5. Name and contact information for Contractor.
  - 6. Name and contact information for Construction Manager.
  - 7. Name and contact information for Architect.
  - 8. Name and contact information for Commissioning Authority.
  - 9. Names and contact information for major consultants to the Architect that designed the systems contained in the manuals.
  - 10. Cross-reference to related systems in other operation and maintenance manuals.
- D. Table of Contents: List each product included in manual, identified by product name, indexed to the content of the volume, and cross-referenced to Specification Section number in Project Manual.
- E. Manual Contents: Organize into sets of manageable size. Arrange contents alphabetically by system, subsystem, and equipment. If possible, assemble instructions for subsystems, equipment, and components of one system into a single binder.
- F. Manuals, Paper Copy: Submit manuals in the form of hard copy, bound and labeled volumes.
  - 1. Binders: Heavy-duty, three-ring, vinyl-covered, loose-leaf binders, in thickness necessary to accommodate contents, sized to hold 8-1/2-by-11-inch paper; with clear plastic sleeve on spine to hold label describing contents and with pockets inside covers to hold folded oversize sheets.
    - a. Identify each binder on front and spine, with printed title "OPERATION AND MAINTENANCE MANUAL," Project title or name, and subject matter of contents, and indicate Specification Section number on bottom of spine. Indicate

volume number for multiple-volume sets.

2. Dividers: Heavy-paper dividers with plastic-covered tabs for each section of the manual. Mark each tab to indicate contents. Include typed list of products and major components of equipment included in the section on each divider, cross-referenced to Specification Section number and title of Project Manual.
3. Protective Plastic Sleeves: Transparent plastic sleeves designed to enclose diagnostic software storage media for computerized electronic equipment.
4. Drawings: Attach reinforced, punched binder tabs on drawings and bind with text.
  - a. If oversize drawings are necessary, fold drawings to same size as text pages and use as foldouts.
  - b. If drawings are too large to be used as foldouts, fold and place drawings in labeled envelopes and bind envelopes in rear of manual. At appropriate locations in manual, insert typewritten pages indicating drawing titles, descriptions of contents, and drawing locations.

## 2.2 EMERGENCY MANUALS

- A. Content: Organize manual into a separate section for each of the following:
  1. Type of emergency.
  2. Emergency instructions.
  3. Emergency procedures.
- B. Type of Emergency: Where applicable for each type of emergency indicated below, include instructions and procedures for each system, subsystem, piece of equipment, and component:
  1. Fire.
  2. Flood.
  3. Gas leak.
  4. Water leak.
  5. Power failure.
  6. Water outage.
  7. System, subsystem, or equipment failure.
  8. Chemical release or spill.
- C. Emergency Instructions: Describe and explain warnings, trouble indications, error messages, and similar codes and signals. Include responsibilities of Owner's operating personnel for notification of Installer, supplier, and manufacturer to maintain warranties.
- D. Emergency Procedures: Include the following, as applicable:
  1. Instructions on stopping.
  2. Shutdown instructions for each type of emergency.
  3. Operating instructions for conditions outside normal operating limits.
  4. Required sequences for electric or electronic systems.
  5. Special operating instructions and procedures.

## 2.3 OPERATION MANUALS

- A. Content: In addition to requirements in this Section, include operation data required in individual Specification Sections and the following information:
1. System, subsystem, and equipment descriptions. Use designations for systems and equipment indicated on Contract Documents.
  2. Performance and design criteria if Contractor is delegated design responsibility.
  3. Operating standards.
  4. Operating procedures.
  5. Operating logs.
  6. Wiring diagrams.
  7. Control diagrams.
  8. Piped system diagrams.
  9. Precautions against improper use.
  10. License requirements including inspection and renewal dates.
- B. Descriptions: Include the following:
1. Product name and model number. Use designations for products indicated on Contract Documents.
  2. Manufacturer's name.
  3. Equipment identification with serial number of each component.
  4. Equipment function.
  5. Operating characteristics.
  6. Limiting conditions.
  7. Performance curves.
  8. Engineering data and tests.
  9. Complete nomenclature and number of replacement parts.
- C. Operating Procedures: Include the following, as applicable:
1. Startup procedures.
  2. Equipment or system break-in procedures.
  3. Routine and normal operating instructions.
  4. Regulation and control procedures.
  5. Instructions on stopping.
  6. Normal shutdown instructions.
  7. Seasonal and weekend operating instructions.
  8. Required sequences for electric or electronic systems.
  9. Special operating instructions and procedures.
- D. Systems and Equipment Controls: Describe the sequence of operation, and diagram controls as installed.
- E. Piped Systems: Diagram piping as installed, and identify color-coding where required for identification.

## 2.4 PRODUCT MAINTENANCE MANUALS

- A. Content: Organize manual into a separate section for each product, material, and finish. Include source information, product information, maintenance procedures, repair materials and sources, and warranties and bonds, as described below.
- B. Source Information: List each product included in manual, identified by product name and arranged to match manual's table of contents. For each product, list name, address, and telephone number of Installer or supplier and maintenance service agent, and cross-reference Specification Section number and title in Project Manual.
- C. Product Information: Include the following, as applicable:
  - 1. Product name and model number.
  - 2. Manufacturer's name.
  - 3. Color, pattern, and texture.
  - 4. Material and chemical composition.
  - 5. Reordering information for specially manufactured products.
- D. Maintenance Procedures: Include manufacturer's written recommendations and the following:
  - 1. Inspection procedures.
  - 2. Types of cleaning agents to be used and methods of cleaning.
  - 3. List of cleaning agents and methods of cleaning detrimental to product.
  - 4. Schedule for routine cleaning and maintenance.
  - 5. Repair instructions.
- E. Repair Materials and Sources: Include lists of materials and local sources of materials and related services.
- F. Warranties and Bonds: Include copies of warranties and bonds and lists of circumstances and conditions that would affect validity of warranties or bonds.

## 2.5 SYSTEMS AND EQUIPMENT MAINTENANCE MANUALS

- A. Content: For each system, subsystem, and piece of equipment not part of a system, include source information, manufacturers' maintenance documentation, maintenance procedures, maintenance and service schedules, spare parts list and source information, maintenance service contracts, and warranty and bond information, as described below.
- B. Source Information: List each system, subsystem, and piece of equipment included in manual, identified by product name and arranged to match manual's table of contents. For each product, list name, address, and telephone number of Installer or supplier and maintenance service agent, and cross-reference Specification Section number and title in Project Manual.
- C. Manufacturers' Maintenance Documentation: Manufacturers' maintenance documentation including the following information for each component part or piece of equipment:

1. Standard maintenance instructions and bulletins.
  2. Drawings, diagrams, and instructions required for maintenance, including disassembly and component removal, replacement, and assembly.
  3. Identification and nomenclature of parts and components.
  4. List of items recommended to be stocked as spare parts.
- D. Maintenance Procedures: Include the following information and items that detail essential maintenance procedures:
1. Test and inspection instructions.
  2. Troubleshooting guide.
  3. Precautions against improper maintenance.
  4. Disassembly; component removal, repair, and replacement; and reassembly instructions.
  5. Aligning, adjusting, and checking instructions.
  6. Demonstration and training video recording, if available.
- E. Maintenance and Service Schedules: Include service and lubrication requirements, list of required lubricants for equipment, and separate schedules for preventive and routine maintenance and service with standard time allotment.
- F. Spare Parts List and Source Information: Include lists of replacement and repair parts, with parts identified and cross-referenced to manufacturers' maintenance documentation and local sources of maintenance materials and related services.
- G. Maintenance Service Contracts: Include copies of maintenance agreements with name and telephone number of service agent.
- H. Warranties and Bonds: Include copies of warranties and bonds and lists of circumstances and conditions that would affect validity of warranties or bonds.

### PART 3 - EXECUTION

#### 3.1 MANUAL PREPARATION

- A. Emergency Manual: Assemble a complete set of emergency information indicating procedures for use by emergency personnel and by Owner's operating personnel for types of emergencies indicated.
- B. Product Maintenance Manual: Assemble a complete set of maintenance data indicating care and maintenance of each product, material, and finish incorporated into the Work.
- C. Operation and Maintenance Manuals: Assemble a complete set of operation and maintenance data indicating operation and maintenance of each system, subsystem, and piece of equipment not part of a system.
- D. Manufacturers' Data: Where manuals contain manufacturers' standard printed data, include only sheets pertinent to product or component installed. Mark each sheet to identify each



product or component incorporated into the Work. If data include more than one item in a tabular format, identify each item using appropriate references from the Contract Documents. Identify data applicable to the Work and delete references to information not applicable.

- E. Drawings: Prepare drawings supplementing manufacturers' printed data to illustrate the relationship of component parts of equipment and systems and to illustrate control sequence and flow diagrams. Coordinate these drawings with information contained in record Drawings to ensure correct illustration of completed installation.
  - 1. Do not use original project record documents as part of operation and maintenance manuals.
- F. Comply with Section 017700 "Closeout Procedures" for schedule for submitting operation and maintenance documentation.

END OF SECTION 017823

Issued for Construction

Verrill Dana Interior Renovations  
Portland, Maine  
Project No. 16001

## SECTION 017839 - PROJECT RECORD DOCUMENTS

### PART 1 - GENERAL

#### 1.1 SUMMARY

- A. Section includes administrative and procedural requirements for project record documents, including the following:
  - 1. Record Drawings.
  - 2. Record Specifications.
  - 3. Record Product Data.
- B. Related Requirements:
  - 1. Section 017823 "Operation and Maintenance Data" for operation and maintenance manual requirements.

#### 1.2 CLOSEOUT SUBMITTALS

- A. Record Drawings: Comply with the following:
  - 1. Number of Copies: Submit copies of record Drawings as follows:
    - a. Initial Submittal:
      - 1) Submit one paper-copy set(s) of marked-up record prints.
    - b. Final Submittal:
      - 1) Submit one paper-copy set(s) of marked-up record prints.
- B. Record Specifications: Submit one paper copy of Project's Specifications, including addenda and contract modifications.
- C. Record Product Data: Submit one paper copy of each submittal.

### PART 2 - PRODUCTS

#### 2.1 RECORD DRAWINGS

- A. Record Prints: Maintain one set of marked-up paper copies of the Contract Drawings and Shop Drawings, incorporating new and revised Drawings as modifications are issued.

1. Preparation: Mark record prints to show the actual installation where installation varies from that shown originally. Require individual or entity who obtained record data, whether individual or entity is Installer, subcontractor, or similar entity, to provide information for preparation of corresponding marked-up record prints.
    - a. Give particular attention to information on concealed elements that would be difficult to identify or measure and record later.
    - b. Record data as soon as possible after obtaining it.
    - c. Record and check the markup before enclosing concealed installations.
  2. Mark the Contract Drawings and Shop Drawings completely and accurately. Use personnel proficient at recording graphic information in production of marked-up record prints.
  3. Mark record sets with erasable, red-colored pencil. Use other colors to distinguish between changes for different categories of the Work at same location.
  4. Note Construction Change Directive numbers, alternate numbers, Change Order numbers, and similar identification, where applicable.
- B. Format: Identify and date each record Drawing; include the designation "PROJECT RECORD DRAWING" in a prominent location.
1. Record Prints: Organize record prints and newly prepared record Drawings into manageable sets. Bind each set with durable paper cover sheets. Include identification on cover sheets.
  2. Identification: As follows:
    - a. Project name.
    - b. Date.
    - c. Designation "PROJECT RECORD DRAWINGS."
    - d. Name of Architect and Construction Manager.
    - e. Name of Contractor.

## 2.2 RECORD SPECIFICATIONS

- A. Preparation: Mark Specifications to indicate the actual product installation where installation varies from that indicated in Specifications, addenda, and contract modifications.
1. Give particular attention to information on concealed products and installations that cannot be readily identified and recorded later.
  2. Mark copy with the proprietary name and model number of products, materials, and equipment furnished, including substitutions and product options selected.
  3. Record the name of manufacturer, supplier, Installer, and other information necessary to provide a record of selections made.
  4. Note related Change Orders, record Product Data, and record Drawings where applicable.
- B. Format: Submit record Specifications as paper copy.

## 2.3 RECORD PRODUCT DATA

- A. Preparation: Mark Product Data to indicate the actual product installation where installation varies substantially from that indicated in Product Data submittal.
  - 1. Give particular attention to information on concealed products and installations that cannot be readily identified and recorded later.
  - 2. Include significant changes in the product delivered to Project site and changes in manufacturer's written instructions for installation.
  - 3. Note related Change Orders, record Specifications, and record Drawings where applicable.
- B. Format: Submit record Product Data as paper copy.

## 2.4 MISCELLANEOUS RECORD SUBMITTALS

- A. Assemble miscellaneous records required by other Specification Sections for miscellaneous record keeping and submittal in connection with actual performance of the Work. Bind or file miscellaneous records and identify each, ready for continued use and reference.
- B. Format: Submit miscellaneous record submittals as paper copy.

## PART 3 - EXECUTION

### 3.1 RECORDING AND MAINTENANCE

- A. Recording: Maintain one copy of each submittal during the construction period for project record document purposes. Post changes and revisions to project record documents as they occur; do not wait until end of Project.
- B. Maintenance of Record Documents and Samples: Store record documents and Samples in the field office apart from the Contract Documents used for construction. Do not use project record documents for construction purposes. Maintain record documents in good order and in a clean, dry, legible condition, protected from deterioration and loss. Provide access to project record documents for Architect's and Construction Manager's reference during normal working hours.

END OF SECTION 017839

Issued for Construction

Verrill Dana Interior Renovations  
Portland, Maine  
Project No. 16001

## SECTION 017900 - DEMONSTRATION AND TRAINING

### PART 1 - GENERAL

#### 1.1 SUMMARY

- A. Section includes administrative and procedural requirements for instructing Owner's personnel, including the following:
  - 1. Demonstration of operation of systems, subsystems, and equipment.
  - 2. Training in operation and maintenance of systems, subsystems, and equipment.
  - 3. Demonstration and training video recordings.

#### 1.2 INFORMATIONAL SUBMITTALS

- A. Instruction Program: Submit outline of instructional program for demonstration and training, including a list of training modules and a schedule of proposed dates, times, length of instruction time, and instructors' names for each training module. Include learning objective and outline for each training module.
  - 1. Indicate proposed training modules using manufacturer-produced demonstration and training video recordings for systems, equipment, and products in lieu of video recording of live instructional module.

#### 1.3 CLOSEOUT SUBMITTALS

- A. Demonstration and Training Video Recordings: Submit two copies within seven days of end of each training module.
  - 1. At completion of training, submit complete training manual(s) for Owner's use prepared and bound in format matching operation and maintenance manuals.

#### 1.4 QUALITY ASSURANCE

- A. Facilitator Qualifications: A firm or individual experienced in training or educating maintenance personnel in a training program similar in content and extent to that indicated for this Project, and whose work has resulted in training or education with a record of successful learning performance.
- B. Instructor Qualifications: A factory-authorized service representative, complying with requirements in Section 014000 "Quality Requirements," experienced in operation and maintenance procedures and training.

- C. Preinstruction Conference: Conduct conference at Project site to comply with requirements in Section 013100 "Project Management and Coordination." Review methods and procedures related to demonstration and training.

## 1.5 COORDINATION

- A. Coordinate instruction schedule with Owner's operations. Adjust schedule as required to minimize disrupting Owner's operations and to ensure availability of Owner's personnel.
- B. Coordinate content of training modules with content of approved emergency, operation, and maintenance manuals. Do not submit instruction program until operation and maintenance data has been reviewed and approved by Architect.

## PART 2 - PRODUCTS

### 2.1 INSTRUCTION PROGRAM

- A. Program Structure: Develop an instruction program that includes individual training modules for each system and for equipment not part of a system, as required by individual Specification Sections.
- B. Training Modules: Develop a learning objective and teaching outline for each module. Include a description of specific skills and knowledge that participant is expected to master. For each module, include instruction for the following as applicable to the system, equipment, or component:
  - 1. Basis of System Design, Operational Requirements, and Criteria: Include the following:
    - a. System, subsystem, and equipment descriptions.
    - b. Performance and design criteria if Contractor is delegated design responsibility.
    - c. Operating standards.
    - d. Regulatory requirements.
    - e. Equipment function.
    - f. Operating characteristics.
    - g. Limiting conditions.
    - h. Performance curves.
  - 2. Documentation: Review the following items in detail:
    - a. Emergency manuals.
    - b. Operations manuals.
    - c. Maintenance manuals.
    - d. Project record documents.
    - e. Identification systems.
    - f. Warranties and bonds.
    - g. Maintenance service agreements and similar continuing commitments.



3. Emergencies: Include the following, as applicable:
  - a. Instructions on meaning of warnings, trouble indications, and error messages.
  - b. Instructions on stopping.
  - c. Shutdown instructions for each type of emergency.
  - d. Operating instructions for conditions outside of normal operating limits.
  - e. Sequences for electric or electronic systems.
  - f. Special operating instructions and procedures.
  
4. Operations: Include the following, as applicable:
  - a. Startup procedures.
  - b. Equipment or system break-in procedures.
  - c. Routine and normal operating instructions.
  - d. Regulation and control procedures.
  - e. Control sequences.
  - f. Safety procedures.
  - g. Instructions on stopping.
  - h. Normal shutdown instructions.
  - i. Operating procedures for emergencies.
  - j. Operating procedures for system, subsystem, or equipment failure.
  - k. Seasonal and weekend operating instructions.
  - l. Required sequences for electric or electronic systems.
  - m. Special operating instructions and procedures.
  
5. Adjustments: Include the following:
  - a. Alignments.
  - b. Checking adjustments.
  - c. Noise and vibration adjustments.
  - d. Economy and efficiency adjustments.
  
6. Troubleshooting: Include the following:
  - a. Diagnostic instructions.
  - b. Test and inspection procedures.
  
7. Maintenance: Include the following:
  - a. Inspection procedures.
  - b. Types of cleaning agents to be used and methods of cleaning.
  - c. List of cleaning agents and methods of cleaning detrimental to product.
  - d. Procedures for routine cleaning
  - e. Procedures for preventive maintenance.
  - f. Procedures for routine maintenance.
  - g. Instruction on use of special tools.
  
8. Repairs: Include the following:

- a. Diagnosis instructions.
- b. Repair instructions.
- c. Disassembly; component removal, repair, and replacement; and reassembly instructions.
- d. Instructions for identifying parts and components.
- e. Review of spare parts needed for operation and maintenance.

## PART 3 - EXECUTION

### 3.1 PREPARATION

- A. Assemble educational materials necessary for instruction, including documentation and training module. Assemble training modules into a training manual organized in coordination with requirements in Section 017823 "Operation and Maintenance Data."

### 3.2 INSTRUCTION

- A. Facilitator: Engage a qualified facilitator to prepare instruction program and training modules, to coordinate instructors, and to coordinate between Contractor and Owner for number of participants, instruction times, and location.
- B. Engage qualified instructors to instruct Owner's personnel to adjust, operate, and maintain systems, subsystems, and equipment not part of a system.
  1. Architect will furnish an instructor to describe basis of system design, operational requirements, criteria, and regulatory requirements.
  2. Owner will furnish an instructor to describe Owner's operational philosophy.
  3. Owner will furnish Contractor with names and positions of participants.
- C. Scheduling: Provide instruction at mutually agreed on times. For equipment that requires seasonal operation, provide similar instruction at start of each season.
  1. Schedule training with Owner, through Construction Manager, with at least seven days' advance notice.
- D. Training Location and Reference Material: Conduct training on-site in the completed and fully operational facility using the actual equipment in-place. Conduct training using final operation and maintenance data submittals.
- E. Evaluation: At conclusion of each training module, assess and document each participant's mastery of module by use of a demonstration performance-based test.

### 3.3 DEMONSTRATION AND TRAINING VIDEO RECORDINGS

- A. General: Engage a qualified commercial videographer to record demonstration and training

video recordings. Record each training module separately. Include classroom instructions and demonstrations, board diagrams, and other visual aids, but not student practice.

1. At beginning of each training module, record each chart containing learning objective and lesson outline.
- B. Video Recording Format: Provide high-quality color video recordings with menu navigation in format acceptable to Architect.
- C. Preproduced Video Recordings: Provide video recordings used as a component of training modules in same format as recordings of live training.

END OF SECTION 017900

Issued for Construction

Verrill Dana Interior Renovations  
Portland, Maine  
Project No. 16001

## SECTION 024119 - SELECTIVE STRUCTURE DEMOLITION

### PART 1 - GENERAL

#### 1.1 SUMMARY

##### A. Section Includes:

1. Demolition and removal of selected portions of building or structure.
2. Salvage of existing items to be reused or recycled.

#### 1.2 DEFINITIONS

- A. Remove: Detach items from existing construction and legally dispose of them off-site unless indicated to be removed and salvaged or removed and reinstalled.
- B. Remove and Salvage: Carefully detach from existing construction, in a manner to prevent damage, and deliver to Owner ready for reuse.
- C. Remove and Reinstall: Detach items from existing construction, prepare for reuse, and reinstall where indicated.
- D. Existing to Remain: Existing items of construction that are not to be permanently removed and that are not otherwise indicated to be removed, removed and salvaged, or removed and reinstalled.

#### 1.3 PREINSTALLATION MEETINGS

- A. Predemolition Conference: Conduct conference at Project site.

#### 1.4 INFORMATIONAL SUBMITTALS

- A. Qualification Data: For refrigerant recovery technician.
- B. Predemolition Photographs or Video: Submit before Work begins.
- C. Statement of Refrigerant Recovery: Signed by refrigerant recovery technician.

#### 1.5 CLOSEOUT SUBMITTALS

- A. Landfill Records: Indicate receipt and acceptance of hazardous wastes by a landfill facility licensed to accept hazardous wastes.

1.6 QUALITY ASSURANCE

- A. Refrigerant Recovery Technician Qualifications: Certified by an EPA-approved certification program.

1.7 FIELD CONDITIONS

- A. Conditions existing at time of inspection for bidding purpose will be maintained by Owner as far as practical.
- B. Notify Architect of discrepancies between existing conditions and Drawings before proceeding with selective demolition.
- C. Hazardous Materials: It is not expected that hazardous materials will be encountered in the Work.

- 1. Hazardous materials will be removed by Owner before start of the Work.
- 2. If suspected hazardous materials are encountered, do not disturb; immediately notify Architect and Owner. Hazardous materials will be removed by Owner under a separate

contract.

- D. Storage or sale of removed items or materials on-site is not permitted.
- E. Utility Service: Maintain existing utilities indicated to remain in service and protect them against damage during selective demolition operations.
  - 1. Maintain fire-protection facilities in service during selective demolition operations.

1.8 WARRANTY

- A. Existing Warranties: Remove, replace, patch, and repair materials and surfaces cut or damaged during selective demolition, by methods and with materials so as not to void existing warranties.

PART 2 - PRODUCTS

2.1 PERFORMANCE REQUIREMENTS

- A. Regulatory Requirements: Comply with governing EPA notification regulations before beginning selective demolition. Comply with hauling and disposal regulations of authorities having jurisdiction.
- B. Standards: Comply with ANSI/ASSE A10.6 and NFPA 241.

## PART 3 - EXECUTION

### 3.1 EXAMINATION

- A. Verify that utilities have been disconnected and capped before starting selective demolition operations.
- B. Survey existing conditions and correlate with requirements indicated to determine extent of selective demolition required.
- C. When unanticipated mechanical, electrical, or structural elements that conflict with intended function or design are encountered, investigate and measure the nature and extent of conflict. Promptly submit a written report to Architect.
- D. Perform an engineering survey of condition of building to determine whether removing any element might result in structural deficiency or unplanned collapse of any portion of structure or adjacent structures during selective building demolition operations.
- E. Survey of Existing Conditions: Record existing conditions by use of measured drawings and preconstruction videotapes.

### 3.2 UTILITY SERVICES AND MECHANICAL/ELECTRICAL SYSTEMS

- A. Existing Services/Systems to Remain: Maintain services/systems indicated to remain and protect them against damage.
  - 1. Comply with requirements for existing services/systems interruptions specified in Division 01 Section "Summary."
- B. Existing Services/Systems to Be Removed, Relocated, or Abandoned: Locate, identify, disconnect, and seal or cap off indicated utility services and mechanical/electrical systems serving areas to be selectively demolished.
  - 1. Arrange to shut off indicated utilities with utility companies.
  - 2. If services/systems are required to be removed, relocated, or abandoned, provide temporary services/systems that bypass area of selective demolition and that maintain continuity of services/systems to other parts of building.
  - 3. Disconnect, demolish, and remove fire-suppression systems, plumbing, and HVAC systems, equipment, and components indicated to be removed.
    - a. Piping to Be Removed: Remove portion of piping indicated to be removed and cap or plug remaining piping with same or compatible piping material.

- b. Piping to Be Abandoned in Place: Drain piping and cap or plug piping with same or compatible piping material.
  - c. Equipment to Be Removed: Disconnect and cap services and remove equipment.
  - d. Equipment to Be Removed and Reinstalled: Disconnect and cap services and remove, clean, and store equipment; when appropriate, reinstall, reconnect, and make equipment operational.
  - e. Equipment to Be Removed and Salvaged: Disconnect and cap services and remove equipment and deliver to Owner.
  - f. Ducts to Be Removed: Remove portion of ducts indicated to be removed and plug remaining ducts with same or compatible ductwork material.
  - g. Ducts to Be Abandoned in Place: Cap or plug ducts with same or compatible ductwork material.
- C. Refrigerant: Remove refrigerant from mechanical equipment to be selectively demolished according to 40 CFR 82 and regulations of authorities having jurisdiction.

### 3.3 PREPARATION

- A. Site Access and Temporary Controls: Conduct selective demolition and debris-removal operations to ensure minimum interference with roads, streets, walks, walkways, and other adjacent occupied and used facilities.
- B. Temporary Facilities: Provide temporary barricades and other protection required to prevent injury to people and damage to adjacent buildings and facilities to remain.
- C. Temporary Shoring: Provide and maintain shoring, bracing, and structural supports as required to preserve stability and prevent movement, settlement, or collapse of construction and finishes to remain, and to prevent unexpected or uncontrolled movement or collapse of construction being demolished.

### 3.4 SELECTIVE DEMOLITION, GENERAL

- A. General: Demolish and remove existing construction only to the extent required by new construction and as indicated. Use methods required to complete the Work within limitations of governing regulations and as follows:
  - 1. Neatly cut openings and holes plumb, square, and true to dimensions required. Use cutting methods least likely to damage construction to remain or adjoining construction. Use hand tools or small power tools designed for sawing or grinding, not hammering and chopping, to minimize disturbance of adjacent surfaces. Temporarily cover openings to remain.



2. Cut or drill from the exposed or finished side into concealed surfaces to avoid marring existing finished surfaces.
3. Do not use cutting torches until work area is cleared of flammable materials. At concealed spaces, such as duct and pipe interiors, verify condition and contents of hidden space before starting flame-cutting operations. Maintain fire watch and portable fire-suppression devices during flame-cutting operations.
4. Locate selective demolition equipment and remove debris and materials so as not to impose excessive loads on supporting walls, floors, or framing.
5. Dispose of demolished items and materials promptly.

B. Removed and Salvaged Items:

1. Clean salvaged items.
2. Pack or crate items after cleaning. Identify contents of containers.
3. Store items in a secure area until delivery to Owner.
4. Transport items to Owner's storage area designated by Owner.
5. Protect items from damage during transport and storage.

C. Removed and Reinstalled Items:

1. Clean and repair items to functional condition adequate for intended reuse.
2. Pack or crate items after cleaning and repairing. Identify contents of containers.
3. Protect items from damage during transport and storage.
4. Reinstall items in locations indicated. Comply with installation requirements for new materials and equipment. Provide connections, supports, and miscellaneous materials necessary to make item functional for use as indicated.

D. Existing Items to Remain: Protect construction indicated to remain against damage and soiling during selective demolition. When permitted by Architect, items may be removed to a suitable, protected storage location during selective demolition and cleaned and reinstalled in their original locations after selective demolition operations are complete.

### 3.5 DISPOSAL OF DEMOLISHED MATERIALS

A. General: Except for items or materials indicated to be recycled, reused, salvaged, reinstalled, or otherwise indicated to remain Owner's property, remove demolished materials from Project site and legally dispose of them in an EPA-approved landfill.

1. Do not allow demolished materials to accumulate on-site.
2. Remove and transport debris in a manner that will prevent spillage on adjacent surfaces and areas.
3. Remove debris from elevated portions of building by chute, hoist, or other device that will convey debris to grade level in a

controlled descent.

- B. Burning: Do not burn demolished materials.
- C. Disposal: Transport demolished materials off Owner's property and legally dispose of them.

### 3.6 CLEANING

- A. Clean adjacent structures and improvements of dust, dirt, and debris caused by selective demolition operations. Return adjacent areas to condition existing before selective demolition operations began.

END OF SECTION 024119

SECTION 030130  
CONCRETE REPAIR

PART 1 - GENERAL

1.01 SECTION INCLUDES

- A. Materials, equipment, services, hardware and labor required for repairing and patching existing concrete as follows:
  - 1. Removal of deteriorated concrete and subsequent replacement and patching.
  - 2. Epoxy crack injection.
  - 3. Leveling of existing concrete slab.

1.02 RELATED DOCUMENTS

- A. Drawings and general provisions of the Contract, including General and Supplementary Conditions and Division 01 Specification Sections, apply to this section.
- B. General Notes, Plans, Sections, Typical Details and other notes indicated on the structural drawings. In cases of conflict, the strictest interpretations shall govern between the specifications and structural drawings.
- C. All Specifications and Drawings shall be examined for requirements affecting the work of this trade. Coordinate work with that of other trades.

1.03 REFERENCE SPECIFICATIONS

- A. Codes and Standards: Work on this project shall conform to all requirements of the current version of the specifications or guides listed below except as modified by these contract documents.
  - 1. ACI 546R – Guide to Concrete Repair
  - 2. ACI 546.3R – Guide for Material Selection for Concrete Repair

1.04 SUBMITTALS

- A. Product Information:
  - 1. Submit product information for each product specified demonstrating compliance with specified requirements and appropriateness for application shown.

1.05 QUALITY ASSURANCE

- A. Contractor shall be responsible for all quality assurance, including both the workmanship and the material provided by his subcontractors and/or furnished by the material suppliers.
- B. Contractor shall employ a competent foreman with a minimum of 5 years experience and thoroughly conversant with all practical working details of concrete repair and restoration.

- C. In the event of a conflict between the contract documents and the specifications a “Request for Information” (RFI) shall be submitted to the Architect and/or “Structural Engineer of Record” (SER) for clarification.

#### 1.06 DELIVERY, STORAGE AND HANDLING

- A. Deliver materials to project site in original unopened containers with labels indicating manufacturer, product name, expiration period for use, pot life and curing time.
- B. Store and handle materials in a manner to prevent their deterioration or damage due to moisture, temperature changes, contaminants, or other causes.

#### 1.07 PROJECT CONDITIONS

- A. Environmental Conditions: Do not proceed with concrete patches or joint sealants under the following conditions:
1. When ambient and substrate temperature limits are outside the limits permitted by the product manufacturer.
  2. When substrates are wet due to rain, frost, condensation or other causes, or when substrate surface temperature is less than 5° F above the dewpoint temperature.
  3. When rain is predicted or anticipated within 4 hours after application of materials.

### PART 2 - PRODUCTS

#### 2.01 MATERIALS

- A. Epoxy Bonding Adhesive: ASTM C 881
1. Two-part structural epoxy adhesive.
  2. Used to bond fresh, plastic concrete or patching mortar to hardened concrete.
  3. Standards:
    - a. Sikadur 32, Hi-Mod by Sika Corporation.
    - b. Euco 452 by The Euclid Chemical Company
- B. Doweling Adhesive Anchor System:
1. Moisture insensitive epoxy.
  2. Use to anchor reinforcing steel into hardened concrete.
  3. Standards:
    - a. “HIT-HY 200” by Hilti Fastening Systems.
    - b. “SET-XP” by Simpson Strong-Tie Company, Inc.
    - c. “Sika AnchorFix-3001” by Sika Corporation
    - d. Approved equal: submit literature including depth of embedment to develop reinforcing bars/anchor rod and spacing requirements.
  4. Drilled hole size and installation procedure shall conform to manufacturer's instructions.
  5. Use carbide bit drill to prevent damage to reinforcement.

**C. Patching Material:**

1. Use to repair honeycombed and other defective concrete.
2. Standards:
  - a. SikaTop 122 PLUS (horizontal surfaces), by the Sika Corporation.
  - b. SikaTop 123 PLUS (overhead and vertical surfaces), by the Sika Corporation.
  - c. "MasterEmaco T 310CL" (horizontal surfaces) by BASF Construction Chemicals
  - d. "MasterEmaco N400" (vertical and overhead surfaces) by BASF Construction Chemicals

**D. Self-leveling Underlayment Concrete:**

1. Material shall be compatible with floor finishes.
2. Material shall be used on floors that will receive a floor covering.
3. Standards:
  - a. "Ardex K 15" by Ardex Americas
  - b. "MasterTop 110SL" by BASF Construction Chemicals
  - c. "Level-Right" by Maxxon Corporation
  - d. "Flo-Top" by The Euclid Chemical Company
  - e. "Sika Level 125" by Sika Corporation

**E. Epoxy Crack-Injection Adhesive: 100 percent solids, high modulus, low viscosity, moisture tolerant, epoxy polymer, for gravity feed or pressure injection of concrete cracks (ASTM C 881).**

1. Tensile Strength: Not less than 7000 psi (48.3 MPa), when tested in accordance with ASTM D 638.
2. Concrete Bond Strength: Not less than 3600 psi (24.8 MPa) after 14 days, when tested in accordance with ASTM C 882.
3. Capping Adhesive: Product manufactured for use with crack-injection adhesive by same manufacturer.

**PART 3 - EXECUTION****3.01 PREPARATION OF PATCHED AREAS**

- A. Saw-cut perimeter of area to be patched. Prior to saw-cutting, use an R-meter to locate reinforcing. Adjust location of cut as required to avoid cutting reinforcing.
- B. Surface shall be prepared as recommended by the product manufacturer.
- C. Substrate surface must be clean and sound. Remove all deteriorated concrete, dirt, oil, grease or any other bond-inhibiting materials.
- D. Extend limits of patch as required so that all deteriorated concrete is removed.
- E. Surface should then be dry-swept or vacuumed to clear off debris and soot, then washed with clean water and brushed.

3.02 APPLICATION OF POLYMER MODIFIED CONCRETE PATCH

- A. Strictly comply with all manufacturers' requirements for application of polymer modified concrete.
- B. Surface shall be saturated surface dry (SSD).
- C. Coat surface with bonding agent.
- D. Fill repair, consolidate and then screed.
- E. Provide broom finish (for slabs).
- F. Cure patch with wet burlap and polyethylene.
- G. Cover to protect from rain if necessary.

END OF SECTION

SECTION 051200  
STRUCTURAL STEEL FRAMING

PART 1 - GENERAL

1.01 SECTION INCLUDES

- A. The work under this Section consists of providing all labor, materials and equipment necessary or required for the complete fabrication and erection of all structural steel as detailed on the Structural Drawings and as specified herein. The work includes furnishing and installing all steel accessories and the non-shrink grout beneath the structural steel.
  - 1. Structural Steel
  - 2. Bolts, washers and other steel accessories
  - 3. Non-shrink grout
  - 4. Anchor rods, embed plates, and other embed connection components. To be furnished but not installed.

1.02 RELATED DOCUMENTS

- A. Drawings and general provisions of the Contract, including General and Supplementary Conditions and Division 01 Specification Sections, apply to this section.
- B. General Notes, Plans, Sections, Typical Details and other notes indicated on the structural drawings. In cases of conflict, information indicated on the structural drawings shall govern.
- C. All Specifications and Drawings shall be examined for requirements affecting the work of this trade. Coordinate work with that of other trades.

1.03 RELATED SECTIONS

- A. Metal Fabrications – Section 055000
- B. Division 9 Section “Paintings and Coatings” for surface preparation and priming requirements.

1.04 DEFINITIONS

- A. Structural Steel: Elements of the structural frame indicated on Drawings and as described in AISC 303, "Code of Standard Practice for Steel Buildings and Bridges."

1.05 COORDINATION

- A. Coordinate selection of shop primers with topcoats to be applied over them. Comply with paint and coating manufacturers' written recommendations to ensure that shop primers and topcoats are compatible with one another.
- B. Coordinate installation of anchorage items to be embedded in or attached to other construction without delaying the Work. Provide setting diagrams, sheet metal templates, instructions, and directions for installation

## 1.06 QUALITY ASSURANCE

- A. The latest editions of the following standard specifications and guides shall govern the fabrication and erection of the structural steel, except as modified by the design drawings or this specification:
  - 1. AISC 360 “Specifications for Structural Steel Buildings”.
  - 2. AISC 303 “Code of Standard Practice for Steel Buildings and Bridges”.
  - 3. RCSC “Specification for Structural Joints Using ASTM A325 or A490 Bolts”.
  - 4. AWS “Structural Welding Code D1.1” for steel.
  - 5. Steel Structures Painting Council Specifications SSPC.
- B. All welders in both shop and field shall be certified under AWS "Standard Qualification Procedure" for the type or types of welding being performed and shall have been continuously engaged in such welding.
- C. Fabricator and Erector shall have continuous business operation for at least 5 years. Furthermore, by evidence of a minimum of 5 projects similar in complexity to this project, indicate capability of conducting work of a similar nature; have sufficient well maintained equipment to perform the work; maintain an adequate stockpile of materials; and have qualified labor to fabricate or erect without delaying the project.

## 1.07 SUBMITTALS

- A. General:
  - 1. Review of requested submittals shall be of a general nature only, and complete conformance to the Contract Documents shall remain the sole responsibility of the Contractor. Review by the Engineer shall not imply nor state that the submittal correctly portrays the requirements of the Contract Documents.
  - 2. Submit the proposed “Shop Drawing Submittal Schedule” prior to submitting any of the shop drawings for review. The submittal schedule shall be developed by the General Contractor and agreed upon between the Architect, Engineer, and General Contractor. Submission schedule shall be issued within 30 days following the start of the project.
  - 3. Requested submittals will shall be reviewed and returned to the Architect within 10 working days.
  - 4. Submittals shall be reviewed by the General Contractor prior to submitting to the Engineer. Submittals without the General Contractor’s review stamp and signature will not be reviewed.
  - 5. Submittals will be reviewed a maximum of two review cycles. General Contractor shall compensate Engineer for additional submittal reviews due to unacceptable or incomplete information.
  - 6. All submittals shall include (1) hard copy and (1) protected document format (PDF) copy. Hard copy will be retained. PDF copy will be marked-up and returned to the Architect for distribution. Review cycle will commence with receipt of both copies.



**B. Shop Drawings:**

1. Shop Drawings shall be submitted to the Architect and will be checked by the Architect/Engineer for correct interpretation and conformance of the Contract Documents, however, this check shall not relieve the General Contractor from ensuring that the shop drawings conform to the Contract Documents.
2. Shop Drawing Action Codes: Submittals reviewed by the Structural Engineer of Record (SER) shall be stamped as identified below:
  - a. Reviewed – No Exceptions: Materials, sizes, general arrangement and details shown appear to be in general conformance with the intent of the contract documents.
  - b. Reviewed – Exceptions Noted: Inclusion of corrections noted will result in submittal being in general conformance with the materials, sizes, general arrangement and details noted in the contract documents. Re-submittal is not required. All corrections shall be considered fully understood unless specifically identified and coordinated with the Structural Engineer of Record (SER).
  - c. Revise & Resubmit: Inclusion of corrections noted will result in submittal being in general conformance with the materials, sizes, general arrangement and details noted in the contract documents. Portions of the submittal specifically requested in writing by the Structural Engineer of Record (SER) shall be re-submitted for review prior to fabrication, purchase, or use.
  - d. Rejected: Fabrication, purchase or use shall not occur prior to the submittal being revised, res-submitted, and reviewed by the Structural Engineer of Record (SER) and all other parties involved.
3. Resubmitted shop drawings:
  - a. All information which is correct on the original submittal will not be changed in any way on the resubmitted shop drawings.
  - b. Shop drawings that have been re-submitted will not be reviewed unless any and all revisions are “clouded”. Only “clouded” items will be reviewed.
4. Shop drawings shall be prepared in accordance with the following:
  - a. Shop Drawings shall include erection plans, framing elevations, all shop and erection details including copes, cuts, holes, connections, threaded fasteners, and welds.
  - b. Provide setting drawings, templates and directions for installation of anchor rods and other devices.
  - c. Erection plans shall clearly denote locations of all connections which require field welds, slip critical bolts, and any bolts other than 3/4” diameter A325, if specified.
  - d. Shop drawings shall include the grade of steel, connection bolt and anchor rod material types, and the type of welding rods.
  - e. Submit a dimensioned layout of shear connectors for each composite steel beam.
  - f. Identify surface preparation and finishes.
5. Delegated-Design Connection Submittal:

- a. The General Contractor is responsible for the design of all connections not specifically designed and detailed on the Contract Documents or covered by AISC design tables.
  - b. Connection design may utilize either “Load and Resistance Factor Design” or “Allowable Stress Design” specifications.
  - c. All connection designs and details are subject to acceptance by the Structural Engineer of Record (SER).
  - d. Calculations shall be prepared under the supervision of a Registered Professional Engineer fully experienced in steel connection design. Connection calculations are to be signed and sealed by a Professional Engineer registered in the State where the project is located.
  - e. Signed and sealed connection designs shall be submitted with the structural steel shop drawing submittal. Structural steel submittals will be returned without review if provided without supporting connection design calculations.
  - f. Calculations and details shall be clearly keyed to the appropriate members on the construction documents.
  - g. General Contractor is responsible for ensuring all connections meet the requirements of AISC standards. All components necessary to construct complete connections, including shop and field welding, bolting, connection plates and angles shall be included.
6. Informational Submittals:
- a. Mill test reports for structural steel, bolts, nuts, and washers, including chemical and physical properties.
  - b. Product Test Reports: For the following:
    - 1) Bolts, nuts, and washers including mechanical properties and chemical analysis. Certifications for high strength bolts shall conform to certification requirements per ASTM A325 and ASTM A490.
    - 2) Post-installed anchors and associated ES Reports by ICC Evaluation Services
    - 3) Shop primers.
    - 4) Non-shrink grout.
    - 5) Welding electrodes, fluxes, and shielded gas products
  - c. Survey of existing conditions.
  - d. Field quality-control and special inspection reports.
- C. Certifications:
1. Fabricator/erector to provide certification for all welders used in field and shop work.
  2. Fabricator to provide certification that the shop drawings and fabricated steel conforms to the contract documents for the project.
  3. Fabricator to provide certification that shop primers are compatible with finish topcoats specified for the project.

## 1.08 DELIVERY, STORAGE AND HANDLING

- A. Store materials to permit easy access for inspection and identification. Keep steel members off ground and spaced by using pallets, dunnage, or other supports and spacers. Protect steel members and packaged materials from corrosion and deterioration. Keep material protected from dirt, grease, or other foreign matter.
  - 1. Do not store materials in a manner that might cause distortion, damage, or overload to members or supporting structures. Any materials exhibiting damage shall be repaired or replaced as directed by the Engineer, and at no additional cost to the Owner.
- B. Store fasteners in a protected place in sealed containers with manufacturer's labels intact.
  - 1. Fasteners may be repackaged provided Owner's testing and inspecting agency observes repackaging and seals containers.
  - 2. Clean and re-lubricate bolts and nuts that become dry or rusty before use.
  - 3. Comply with manufacturers' written recommendations for cleaning and lubricating ASTM F 1852 fasteners and for retesting fasteners after lubrication.
- C. Requirements for storage and handling of electrodes shall be per AWS D1.1.

#### 1.09 COORDINATION

- A. Coordinate delivery of anchor bolts and anchorage devices to be embedded into concrete prior to start of concrete construction to avoid disruption to schedule.
- B. As-built field surveys and verifications shall be completed by the Contractor as required to document existing conditions from completed concrete construction or existing buildings prior to the development of shop drawings.
- C. Coordinate selection of shop primers with topcoats to be applied over them, where specified. Comply with paint and coating manufacturer's recommendations to ensure that shop primers and topcoats are compatible.

### PART 2 - PRODUCTS

#### 2.01 MATERIALS

- A. W-Shapes: ASTM A992, Grade 50 (Fy = 50 ksi)
- B. Column Base Plates: ASTM A36 (Fy = 36 ksi), unless noted otherwise.
- C. Angles, Channels, Plates and Bars: ASTM A36 (Fy = 36 ksi)
- D. Rectangular and Square HSS: ASTM A500, Grade B (Fy = 46 ksi)
- E. Round HSS members: ASTM A500, Grade B (Fy=42 ksi)
- F. Structural steel pipe: ASTM A53, Type E or S, Grade B (Fy = 35 ksi)

## 2.02 BOLTS, CONNECTORS AND ANCHORS

### A. Heavy-hex steel structural bolts:

1. ASTM A325 Bolt, Type 1: Minimum tensile strength 120 ksi
  - a. Heavy-hex nuts: ASTM A563, Grade C
  - b. Hardened washers: ASTM F436, Type 1
  - c. Galvanizing, if specified: Hot-dipped (ASTM A153, Class C) or mechanically deposited (ASTM B695, Class 50) zinc coating
2. ASTM A490 Bolt, Type 1: Minimum tensile strength 150 ksi
  - a. Heavy-hex nuts: ASTM A563, Grade DH
  - b. Hardened washers: ASTM F436, Type 1
  - c. Galvanizing, if specified: Hot-dipped (ASTM A153, Class C) or mechanically deposited (ASTM B695, Class 50) zinc coating

### B. Anchor rods: ASTM F1554, Grades 36, 55 or 105 as indicated.

1. Configuration: Straight (hooked anchor bolts are not permitted, u.n.o.)
2. Heavy-hex nuts: ASTM A563, Grade C
3. Hardened washers: ASTM F436, Type 1
4. Plate washers: ASTM A36 carbon steel
5. Galvanizing, if specified: Hot-dipped (ASTM A153, Class C) or mechanically deposited (ASTM B695, Class 50) zinc coating

### C. Post-Installed Expansion Anchors:

1. Expansion anchor appropriate for attachment to solid masonry or concrete (cracked or un-cracked), with diameter, embedment and finish as indicated on the contract documents. Acceptable products include, but are not limited to the following:
  - a. "Kwik Bolt-TZ" Expansion Anchor by Hilti, Inc.
  - b. "Power-Stud+SD2" Expansion Anchor by Powers Fasteners, Inc.
  - c. "Strong-Bolt" Expansion Anchor by Simpson Strong-Tie Company, Inc.
2. Expansion anchor shall have an ES Report demonstrating the anchor has met the requirements of AC 193 for mechanical anchors as specified by the International Code Council (ICC).

### D. Post-Installed Screw Anchors:

3. Screw anchor appropriate for attachment to solid masonry or concrete (cracked or un-cracked), with diameter, embedment and finish as indicated on the contract documents. Acceptable products include, but are not limited to the following:
  - a. "Kwik HUS-EZ" Screw Anchor by Hilti, Inc.
  - b. "Wedge-Bolt+" Screw Anchor by Powers Fasteners, Inc.
  - c. "Titen HD" Screw Anchor by Simpson Strong-Tie Company, Inc.
4. Expansion anchor shall have an ES Report demonstrating the anchor has met the requirements of AC 193 for mechanical anchors as specified by the International Code Council (ICC).

### E. Post-Installed Anchoring Adhesive System:

1. Anchoring adhesive plus threaded rod appropriate for attachment to solid masonry or concrete (cracked or un-cracked), with diameter, embedment and finish as indicated on the contract documents. Acceptable products include, but are not limited to the following:
  - a. "HIT-HY 200-R Anchoring Adhesive by Hilti, Inc.
  - b. "PE1000+" Anchoring Adhesive by Powers Fasteners, Inc.
  - c. "SET-XP" Anchoring Adhesive by Simpson Strong-Tie Company, Inc.
2. Adhesive anchoring system shall have an ES Report demonstrating the anchor has met the requirements of AC 308 for adhesive anchors as specified by the International Code Council (ICC).

### 2.03 WELDING MATERIALS

- A. Filler metal requirements shall conform to AWS D1.1 and AISC "Specification for Structural Steel Buildings", minimum tensile strength of 70 ksi (E70).
- B. Filler metal "Charpy V-Notch (CVN)" requirements:
  1. 20 ft-lb at 0 degrees Fahrenheit unless noted otherwise
  2. 20 ft-lb at 70 degrees Fahrenheit for all complete penetration (CJP) groove welds.
- C. Welding Rods:
  1. AWS E70XX for A36 steel.
  2. AWS E70XX low hydrogen for Grade 50 steel.

### 2.04 NON-SHRINK GROUT

- A. Shrinkage-resistant Grout shall be non-metallic, non-staining, non-corrosive, factory-packaged requiring only the addition of potable water.
- B. Grout shall attain compressive strengths per ASTM C-1107 and be capable of maintaining a flowable consistency for a minimum of 45 minutes at 70°F.
- C. Grout shall meet the dimensional stability requirements of ASTM C-1107, Grade C, when prepared according to the manufacturer's instructions and tested at 40°F and 90°F.
- D. Standards:
  1. "Five Star Grout" by Five Star Products, Inc.
  2. "SikaGrout 212" by Sika Corporation
  3. "MasterFlow 100" by BASF Corporation
  4. "NS Grout" by The Euclid Chemical Company

### 2.05 SHOP PRIMER

- A. Comply with Division 9 Section "Paintings and Coatings".
- B. Primer shall be compatible with finish paints, intumescent paint and spray-on fireproofing specified elsewhere.

- C. Primer paint shall be lead-free, chromate-free, non-asphaltic, rust-inhibiting and comply with all applicable SSPC requirements.
- D. Galvanizing Repair Paint to comply with ASTM A 780.

### PART 3 - FABRICATION

#### 3.01 SHOP FABRICATION

- A. Fabricate structural steel in accordance with AISC 303 "Code of Standard Practice for Steel Buildings and Bridges" and AISC 360 "Specifications for Structural Steel Buildings". Assemble structural steel members and parts in the shop to its greatest extent possible.
  - 1. Camber structural-steel members where indicated. Camber indicated is the required camber at time of erection. Fabricate beams with rolling camber up.
  - 2. Identify high-strength structural steel according to ASTM A6 and maintain markings until structural steel has been erected.
  - 3. Mark and match-mark materials for field assembly. Members shall be fabricated for delivery in a sequence that will expedite erection and minimize field handling of structural steel.
  - 4. Hollow members exposed to weather shall be sealed with continuous welds, or provided with weep holes to eliminate accumulation of water.
  - 5. Complete structural-steel assemblies, including welding of units, before starting shop-priming operations.
- B. Thermal Cutting:
  - 1. Perform thermal cutting by machine to greatest extent possible.
  - 2. Plane thermally cut edges to be welded to comply with requirements in AWS D1.1.
- C. Cleaning:
  - 1. Clean and prepare steel surfaces that are to remain unpainted in accordance with SSPC-SP2, "Hand Tool Cleaning".
- D. Bolt Holes: Cut, drill, or punch standard bolt holes perpendicular to metal surfaces.
  - 1. Use standard holes unless otherwise indicated on the Contract Documents. Holes shall be drilled or punched perpendicular to the surface of the metal. Making or enlarging holes by burning is not allowed.
  - 2. Flame cut holes for fasteners are not acceptable.
  - 3. Holes in column baseplates shall be drilled (not punched) and shall not be larger than 1/2-inch greater than the nominal bolt size specified.
- E. Openings: Provide openings in structural members as required for securing other work to structural steel and for other work to pass through steel framing members, as shown on final shop drawings.
  - 1. Provide holes, slots, and rectangular/square penetrations, along with specified reinforcing, as indicated on the Contract Documents. Openings shall only be

located where shown on the drawings. If the opening location is to be changed, revised location needs approval by the Structural Engineer of Record (SER) prior to fabrication.

2. Openings shall only be completed in the shop, and shall be coordinated by the Contractor prior to fabrication. Openings will not be allowed in the field unless specifically approved by the Structural Engineer of Record (SER).
3. Holes shall be drilled or punched perpendicular to the surface of the metal. Creating or enlarging holes by burning is not allowed.

F. Finishing:

1. Accurately finish ends of columns and other members transmitting bearing loads.

G. Fabricator, Erector, and General Contractor shall coordinate safety requirements for the project, in accordance with OSHA Part 1926. Provide all necessary pieces and fabrications as required to safely erect and access the structure for the duration of the project construction.

### 3.02 SHOP CONNECTIONS

A. General:

1. Provide high strength threaded fasteners for all bolted connection, except where an alternative is specified in the Contract Documents.
2. Bolts shall be of adequate length to ensure the bolt is at least flush with the surface of the connecting nut and not extending greater than the nut height.
3. Bolts shall be installed with threads excluded from the shear plane, unless indicated otherwise in the contract documents.
4. Washers shall be used for all bolted connections. Use beveled washers where bolts bear on sloping surfaces.

B. Bolted Connections:

1. Shop install high-strength bolts according to RCSC's "Specification for Structural Joints Using ASTM A325 or A490 Bolts" for type of bolt and type of joint specified.
2. Unless otherwise indicated, all bolted connections shall be tightened to snug-tight condition as specified by AISC.

C. Welded Connections:

1. Comply with AWS D1.1 for tolerances, appearances, welding procedure specifications, weld quality, and methods used in correcting welding work.
2. Weld sizes where shown shall be assumed to be "effective weld" sizes.
3. Where structural steel members are to remain exposed in the finished work, welds exposed to view shall be uniformly made and ground smooth, unless noted otherwise in the Contract Documents. Refer to AESS Specifications if applicable.
4. Do not weld at the flange to web intersection of structural steel members denoted by AISC as the "k" and "k1" distances unless specifically noted otherwise.

### 3.03 SHOP PRIMING

- A. Shop prime structural steel surfaces except the following:
  - 1. Contact surfaces of high-strength bolted, slip-critical connections.
  - 2. Surfaces to be field welded.
  - 3. Structural steel that will receive sprayed-on fireproofing.
  - 4. Steel encased in concrete.
  - 5. Embedded steel items (surfaces in contact with concrete).
  - 6. The top surface of the top flange for all composite beams.
  - 7. Crane rails.
  - 8. Galvanized surfaces.
- B. Surface Preparation:
  - 1. Clean surfaces to be painted. Remove loose rust and mill scale and spatter, slag, or flux deposits. Prepare surfaces as follows, unless noted otherwise in contract documents:
    - a. SSPC – SP3 “Power Tool Cleaning” for structural steel not exposed to weather.
    - b. SSPC – SP6 “Commercial Blast Cleaning” for structural steel exposed to weather.
- C. Application of Primer:
  - 1. Immediately after surface preparation, structural steel shall receive shop primer according to manufacturer's written instructions and at rate recommended by SSPC to provide a minimum dry film thickness of 2 mils for interior primer and 3 mils for exterior primer.
  - 2. Use priming methods that result in full coverage of joints, corners, edges, and exposed surfaces.
- D. Field Repairs/Touch-Up:
  - 1. Field repair damaged surfaces or locations not coated in the shop, including but not limited to field welded steel, construction damage, and damage caused by shipping and erection.

### 3.04 SHOP GALVANIZING

- A. Hot-Dip Galvanized Finish:
  - 1. Apply zinc coating by the hot-dip process to structural steel according to ASTM A123 and to bolts, nuts, and washers according to ASTM A153.
  - 2. All steel exposed to the weather in the final structure shall be hot-dipped galvanized, unless noted otherwise in contract documents. The following structural steel items will also require galvanizing:
    - a. Any steel indicated as “galvanized” on the contract drawings as well as all fasteners connecting the galvanized components.
    - b. Steel lintels and shelf angles within the exterior wall assembly.
  - 3. Fill vent and drain holes that are exposed in the finished work unless they function as weep holes, by plugging with zinc solder and filing off smooth.



4. Provide drain holes in closed tubular members to be galvanized. Holes shall not be located to impact the strength of the member. Holes shall be shown on the shop drawings for review by the Engineer.
5. Surface Preparation: SSPC – SP6 “Commercial Blast Cleaning”.

### 3.05 SOURCE QUALITY CONTROL

- A. Testing Agency: Owner will engage a qualified testing agency to perform shop tests and inspections as defined by AWS, AISC, and this specification.
  1. Provide testing agency with access to places where structural steel work is being fabricated or produced to perform tests and inspections.
  2. Owner may waive shop inspections upon receipt of required fabricator certification.
  3. Testing agency shall summarize their findings in inspection and testing reports. Reports shall identify any deficiencies not in compliance with project requirements.
- B. Contractor shall ensure all discrepancies noted in testing agency reports are corrected and re-inspected to confirm acceptable repair. Any costs associated with re-inspection of non-conforming work shall be at the Contractor’s expense.
- C. Bolted Connections: Test and Inspect shop-bolted connections according to RCSC's "Specification for Structural Joints Using ASTM A325 or A490 Bolts."
- D. Welded Connections:
  1. Testing agency shall visually inspect all shop welding of structural steel in accordance with the governing building code and AWS D1.1.
    - a. Multi-pass welds shall be continuously inspected.
  2. In addition to visual inspection, shop-welded connections shall be tested and inspected according to AWS D1.1 and the following inspection procedures, at testing agency's option:
    - a. Ultrasonic Inspection: ASTM E 164.
    - b. Radiographic Inspection: ASTM E 94.
- E. In addition to visual inspection, test and inspect shop-welded shear connectors according to requirements in AWS D1.1 for stud welding and as follows:
  1. Perform bend tests if visual inspections reveal either a less-than-continuous 360-degree flash or welding repairs to any shear connector.
  2. Conduct tests according to requirements in AWS D1.1 on additional shear connectors if weld fracture occurs on shear connectors already tested.

## PART 4 - EXECUTION

### 4.01 EXAMINATION

- A. Prior to the erection of any steel, the Contractor, with the steel erector present, shall verify the location, elevation and plumbness of all anchor rods, bearing plates, embedments and

- concrete surfaces. The Contractor shall report immediately to the Architect/Engineer in writing any condition which he finds unacceptable or that would prevent erection of the structural steel within AISC tolerance for plumbness and elevation. The Contractor shall be responsible for all corrections, and all corrections shall be made in a manner acceptable to the Architect/Engineer.
- B. The erector shall acquaint himself with all conditions at the site, which can affect his methods and sequence of operations. Abide by Owner's regulations concerning traffic, parking and construction material delivery.
  - C. Contractor to furnish all anchor rods for anchorage of structural steel at an advance date for incorporation into the concrete foundation by others. Provide heavy hex nuts and washers for each bolt. Anchor rods shall not be installed until shop drawings have been reviewed.

#### 4.02 PREPARATION

- A. Provide temporary shores, guys, braces, and other supports as required to maintain stability and alignment during erection against temporary construction loads and loads equal in intensity to design loads.
- B. Remove temporary supports only when the entire structural steel system is erected, permanently connected, braced and set. This includes the composite floor slab system, if applicable, where it must attain concrete design compressive strength prior to removal.
- C. Contractor is solely responsible for the inclusion and maintenance of all temporary support systems. Retain the services of a Specialty Structural Engineer (not the Engineer of Record) to design specialty shoring and bracing.

#### 4.03 ERECTION

- A. Erect Steel in accordance with AISC 303 "Code of Standard Practice for Steel Buildings and Bridges" and AISC 360 "Specifications for Structural Steel Buildings".
- B. Set all structural steel accurately to lines and grades. Connect temporarily with sufficient high strength bolts to insure complete safety of the structural until permanent connections are made. Ensure plumbness after erection of each level.
- C. Erection tolerances shall be in accordance with the AISC 303 "Code of Standard Practice for Steel Buildings and Bridges".
- D. Erection procedures shall comply with Occupational Safety and Health Administration (OSHA) "Code of Federal Regulations, Part 1926", latest edition.
- E. Baseplates and Bearing Plates:
  - 1. Concrete surfaces and plates shall be clean and free from rust, grease, oil and other debris. Roughen surfaces prior to setting plates.
  - 2. Set plates for structural members on wedges, shims, or setting nuts as required. Leveling plates under column base plates will not be permitted unless noted otherwise in the contract documents.

3. Snug-tighten anchor rods after supported members have been positioned and plumbed. Do not remove wedges or shims. Welding of anchor rods for corrective measures is not acceptable unless specifically approved by the Structural Engineer.
4. Baseplate grouting:
  - a. Place a watertight form around the area to be grouted. Formwork should be designed to insure free flow of the grout under the baseplate and preventing the creation of air pockets. The height of the formwork should be sufficient to allow for complete gravity fill under the plate.
  - b. Saturate the area to be grouted with water until uniformly damp. Remove excess water just before placing the grout.
  - c. In order to avoid air pockets and ensure complete filling of the cavity between the baseplate and concrete, the grout shall be placed from one side only. Placement shall be completed without interruption.
  - d. Dry packing or damp packing is not allowed.
  - e. See manufacturer's printed instructions for additional information regarding preparation, mixing, placing and curing of the grout.
- F. Any and all misfits shall be reported to the Engineer for resolution. Burning of new or unfair holes or cutting with a torch will not be permitted without the approval of the Engineer. Reamers, twist drills and saws shall be employed where burning is prohibited.
- G. Any member that has assumed a bend or buckle in its final position due to forced fit shall have one or both ends and any intermediate connections unbolted and re-drilled or reamed to relieve such bowing to the satisfaction of the Engineer.
- H. No piece that has been bent, broken, twisted or otherwise damaged shall be incorporated into the work. Such pieces shall be repaired or corrected on the ground to the satisfaction of the Engineer or replaced with a new piece. Failure to observe this will be cause for rejection of the piece in place.
- I. Splice members only where indicated on the Contract Drawings.
- J. Remove Primer or any coating from the area to be welded prior to field welding.

#### 4.04 FIELD CONNECTIONS

##### A. Bolted Connections:

1. Install high-strength bolts according to RCSC's "Specification for Structural Joints Using ASTM A325 or A490 Bolts" for type of bolt.
2. All bolted connections, except for slip critical bolted connections, shall be tightened to snug-tight condition as specified by AISC, unless otherwise noted on Contract Drawings.

##### B. Slip-Critical Bolted Connections:

1. Where slip-critical bolted connections are indicated on the Contract Drawings, the faying surfaces shall be left unpainted.
2. All slip-critical bolts shall be tightened to a minimum pretension according to Table 8.1 of the RCSC "Specification for Structural Joints Using ASTM A325 and A490 Bolts"

## C. Welded Connections:

1. Field welds shall comply with AWS D1.1 “Structural Welding Code” for tolerance, appearances, welding procedure specifications, weld quality and methods used in correcting welding work.
2. Field welds shall be accomplished by welders certified for the weld types and positions involved. Welders in the field shall have current evidence of qualifications.
3. Weld in a manner to prevent warping or distortion of the finished product.
4. Use only shielded arc electrodes, E70xx, structural type. Low hydrogen electrodes shall be stored in strict accordance with the provisions of AWS D1.1.

## D. Welding procedure for galvanized steel:

1. Remove galvanizing from area to be welded
2. Protect units from damage by use of non-combustible shields as required.
3. After welding, remove weld slag.
4. Touch-up area with galvanized paint.

## E. Post Installed Anchor Installation:

1. All anchors shall be installed in accordance with all the manufacturer’s requirements including:
  - a. Diameter of hole and method of drilling hole.
  - b. Condition of hole including moisture, dust and side roughness.
  - c. Temperature during installation.
2. Manufacturer’s representative shall meet with Contractor’s anchor installer prior to installation. Manufacturer’s representative shall review procedures for anchor installation. Contractor’s anchor installer shall install three (3) anchors in presence of the manufacturer’s representative. Installed anchors shall be “proof loaded” to 50 percent of anchor’s ultimate tension capacity. Installer shall not install anchors on project until he has successfully installed three (3) anchors that have met the “proof load” requirements in the opinion of the manufacturer’s representative.
3. When installing expansion or adhesive anchors, locate the reinforcement within the concrete to avoid damaging the reinforcement during the anchor installation process. Post-installed anchors shall be located as shown on the drawings. Any changes of anchor location shall be approved by the Structural Engineer.

## 4.05 FIELD QUALITY CONTROL

- A. The General Contractor shall execute proper quality control measures to ensure the structure is constructed in complete compliance with the Contract Documents. Owner-conducted testing and inspections shall be considered a quality assurance measure, and shall in no way limit or decrease the contractor’s own quality control program requirements. The Contractor is solely responsible for compliance with all Contract Document requirements.
- B. Testing Agency: Owner will engage a qualified independent testing and inspection agency and/or special inspector to perform the following inspections. Agency shall submit reports of all inspections within 48 hours of completion of inspection.

1. Verify structural-steel materials and inspect steel frame joint details.
  2. Verify weld materials and inspect welds.
  3. Verify connection materials and inspect high-strength bolted connections.
- C. Field Bolted Connections: Inspect bolted connections according to RCSC "Specification for Structural Joints Using ASTM A325 or A490 Bolts."
1. Snug Tight Bolted Connections shall be inspected to confirm that all plies of connected material have been drawn together and that the selected procedure is used to tighten all bolts. A test sample of 10% of the bolts in the connection, but not less than 2 bolts selected at random shall be tested to determine that bolts have been tightened to snug tight connection. If failed tests occur, additional bolts shall be tested.
  2. Slip Critical Bolted Connections shall be observed when installed to monitor the calibration of torquing equipment and the installation of bolts to determine that all plies of connected materials have been drawn together and that the selected procedure is used to tighten all bolts. If inspector does not monitor the connection, all bolts in the affected connection shall be tested by using a manual torque wrench to assure that the required pretension has been reached.
- D. Field Welded Connections: Visually inspect field welds according to AWS D1.1.
1. Perform visual inspection of all field welds. Welds deemed questionable shall also receive non-destructive testing. Options for non-destructive testing include:
    - a. Ultrasonic Inspection: ASTM E 164
    - b. Radiographic Inspection: ASTM E 94
  2. Multi-pass fillet welds shall be continuously inspected.
  3. All field moment welds and welds associated with lateral frame assemblies shall be visually inspected and non-destructive tested. Options for non-destructive testing include:
    - a. Ultrasonic Inspection: ASTM E 164.
    - b. Radiographic Inspection: ASTM E 94.
  4. All welds deemed unacceptable shall be repaired and retested at the Contractor's expense.
- E. Test Post-Installed Anchors:
1. The Testing Agency shall randomly select 5 anchors for every 50 installed. Selected anchors shall reflect all types of installations including:
    - a. Overhead horizontal surfaces
    - b. Vertical surfaces
    - c. Sloped or skewed surfaces
  2. "Proof load" each selected anchor to 50% of the anchor's ultimate tensile capacity.
  3. Engineer and Anchor Manufacturer shall be notified immediately if an anchor does not pass test requirements. Contractor shall not proceed with corrective measures without written instructions from the Engineer describing remedial action to be taken.
- F. Testing agency shall visually inspect all field welding of structural steel in accordance with the governing building code and AWS D1.1.

G. Defective Work:

1. Contractor shall be responsible for correcting deficiencies in Work that test reports and inspections indicate do not comply with the Contract Documents. Work deemed defective will be removed from the site at Contractor's expense.
2. Any special tests not covered by this specification that are proposed by the Contractor as a result of failure to comply with this Section shall be at the Contractor's expense. The Contractor shall be responsible for any consequential costs or delays.

4.06 REPAIRS AND PROTECTION

- A. Touch-up Painting: Field bolts, field welds and abrasions to the shop coat shall be repaired and painted by the structural steel erector using the same paint and care as for shop coat. All such surfaces shall be washed with a suitable degreasing solvent. This contractor shall also remove any and all accumulations of mud, clay, rust, scale, grease, etc. that have been acquired, for any reason, during shipment, storage and erection and the shop coat restored to its original condition.
- B. Galvanized Surfaces: Clean areas where galvanizing is damaged or missing and repair galvanizing to comply with ASTM A780.
- C. Repair of Openings: For all members exposed to view in the final structure, close all lifting holes, access openings, etc. in such a manner that no visual evidence of the opening remains.

END OF SECTION

## SECTION 055000 - METAL FABRICATIONS

### PART 1 - GENERAL

#### 1.1 SUMMARY

##### A. Section Includes:

1. Miscellaneous steel framing and supports.
  - a. Steel framing and supports for countertops.
  - b. Steel framing and supports for mechanical and electrical equipment.
2. Steel weld plates and angles for casting into concrete not specified in other Sections.
3. Rough Hardware.

#### 1.2 ACTION SUBMITTALS

##### A. Shop Drawings: Show fabrication and installation details for metal fabrications.

1. Include plans, elevations, sections, and details of metal fabrications and their connections. Show anchorage and accessory items.

### PART 2 - PRODUCTS

#### 2.1 METALS, GENERAL

- ##### A. Metal Surfaces, General: Provide materials with smooth, flat surfaces without blemishes.

#### 2.2 FERROUS METALS

- ##### A. Steel Plates, Shapes, and Bars: ASTM A 36/A 36M.
- ##### B. Stainless-Steel Sheet, Strip, and Plate: ASTM A 240/A 240M or ASTM A 666, Type 304.
- ##### C. Steel Tubing: ASTM A 500, cold-formed steel tubing.

- D. Steel Pipe: ASTM A 53/A 53M, standard weight (Schedule 40) unless otherwise indicated.
- E. Slotted Channel Framing: Cold-formed metal box channels (struts) complying with MFMA-4.
  - 1. Size of Channels: 1-5/8 by 1-5/8 inches.
  - 2. Material: Galvanized steel, ASTM A 653/A 653M, commercial steel, Type B, with G90 coating; 0.108-inch nominal thickness.

### 2.3 FASTENERS

- A. General: Unless otherwise indicated, provide Type 304 stainless-steel fasteners for exterior use and zinc-plated fasteners with coating complying with ASTM B 633 or ASTM F 1941, Class Fe/Zn 5, at exterior walls.
  - 1. Provide stainless-steel fasteners for fastening aluminum.
  - 2. Provide stainless-steel fasteners for fastening stainless steel.
- B. Steel Bolts and Nuts: Regular hexagon-head bolts, ASTM A 307, Grade A (ASTM F 568M, Property Class 4.6); with hex nuts, ASTM A 563 (ASTM A 563M); and, where indicated, flat washers.
- C. Stainless-Steel Bolts and Nuts: Regular hexagon-head annealed stainless-steel bolts, ASTM F 593 (ASTM F 738M); with hex nuts, ASTM F 594 (ASTM F 836M); and, where indicated, flat washers; Alloy Group 1.
- D. Anchor Bolts: ASTM F 1554, Grade 36, of dimensions indicated; with nuts, ASTM A 563; and, where indicated, flat washers.
  - 1. Hot-dip galvanize or provide mechanically deposited, zinc coating where item being fastened is indicated to be galvanized.
- E. Eyebolts: ASTM A 489.
- F. Machine Screws: ASME B18.6.3 (ASME B18.6.7M).
- G. Lag Screws: ASME B18.2.1 (ASME B18.2.3.8M).
- H. Wood Screws: Flat head, ASME B18.6.1.
- I. Plain Washers: Round, ASME B18.22.1 (ASME B18.22M).
- J. Lock Washers: Helical, spring type, ASME B18.21.1 (ASME B18.21.2M).

### 2.4 MISCELLANEOUS MATERIALS

- A. Welding Rods and Bare Electrodes: Select according to AWS specifications for metal alloy welded.



- B. Universal Shop Primer: Fast-curing, lead- and chromate-free, universal modified-alkyd primer complying with MPI#79 and compatible with topcoat.
- C. Galvanizing Repair Paint: High-zinc-dust-content paint complying with SSPC-Paint 20 and compatible with paints specified to be used over it.
- D. Nonshrink, Nonmetallic Grout: Factory-packaged, nonstaining, noncorrosive, nongaseous grout complying with ASTM C 1107. Provide grout specifically recommended by manufacturer for interior and exterior applications.

## 2.5 FABRICATION, GENERAL

- A. Shop Assembly: Preassemble items in the shop to greatest extent possible. Use connections that maintain structural value of joined pieces.
- B. Cut, drill, and punch metals cleanly and accurately. Remove burrs and ease edges. Remove sharp or rough areas on exposed surfaces.
- C. Form bent-metal corners to smallest radius possible without causing grain separation or otherwise impairing work.
- D. Form exposed work with accurate angles and surfaces and straight edges.
- E. Weld corners and seams continuously to comply with the following:
  - 1. Use materials and methods that minimize distortion and develop strength and corrosion resistance of base metals.
  - 2. Obtain fusion without undercut or overlap.
  - 3. Remove welding flux immediately.
  - 4. At exposed connections, finish exposed welds and surfaces smooth and blended.
- F. Form exposed connections with hairline joints, flush and smooth, using concealed fasteners or welds where possible. Locate joints where least conspicuous.
- G. Fabricate seams and other connections that will be exposed to weather in a manner to exclude water. Provide weep holes where water may accumulate.
- H. Cut, reinforce, drill, and tap metal fabrications as indicated to receive finish hardware, screws, and similar items.
- I. Provide for anchorage of type indicated; coordinate with supporting structure. Space anchoring devices to secure metal fabrications rigidly in place and to support indicated loads.
  - 1. Where units are indicated to be cast into concrete or built into masonry, equip with integrally welded steel strap anchors not less than 24 inches o.c.

## 2.6 MISCELLANEOUS FRAMING AND SUPPORTS

- A. General: Provide steel framing and supports not specified in other Sections as needed to complete the Work.
- B. Fabricate units from steel shapes, plates, and bars of welded construction unless otherwise indicated. Fabricate to sizes, shapes, and profiles indicated and as necessary to receive adjacent construction.
  - 1. Fabricate units from slotted channel framing where indicated.
  - 2. Furnish inserts for units installed after concrete is placed.
- C. Galvanize miscellaneous framing and supports where indicated.

## 2.7 STEEL WELD PLATES AND ANGLES

- A. Provide steel weld plates and angles not specified in other Sections, for items supported from concrete construction as needed to complete the work. Provide each unit with not less than two integrally welded steel strap anchors for embedding in concrete.

## 2.8 MISCELLANEOUS STEEL TRIM

- A. Unless otherwise indicated, fabricate units from steel shapes, plates, and bars of profiles shown with continuously welded joints and smooth exposed edges. Miter corners and use concealed field splices where possible.
- B. Provide cutouts, fittings, and anchorages as needed to coordinate assembly and installation with other work.
  - 1. Provide with integrally welded steel strap anchors for embedding in concrete or masonry construction.
- C. Galvanize exterior miscellaneous steel trim.

## 2.9 MISCELLANEOUS FABRICATIONS

- A. Countertop Supports: Fabricate from steel angle with steel gussets to configuration indicated.  
Round edges and ends to remove sharp edges.

## 2.10 ROUGH HARDWARE

- A. Furnish bent, or otherwise custom-fabricated, bolts, plates, anchors, hangers, dowels, and other miscellaneous steel and iron shapes as required for framing and supporting woodwork, and for anchoring or securing woodwork to concrete or other structures. Straight bolts and other stock rough hardware items are specified in Division 06 Sections.

- B. Fabricate items to sizes, shapes, and dimensions required. Furnish malleable-iron washers for heads and nuts that bear on wood structural connections, and furnish steel washers elsewhere.

## 2.11 FINISHES, GENERAL

- A. Comply with NAAMM's "Metal Finishes Manual for Architectural and Metal Products" for recommendations for applying and designating finishes.
- B. Finish metal fabrications after assembly.

## 2.12 STEEL AND IRON FINISHES

- A. Galvanizing: Hot-dip galvanize items as indicated to comply with ASTM A 153/A 153M for steel and iron hardware and with ASTM A 123/A 123M for other steel and iron products.
  - 1. Do not quench or apply post galvanizing treatments that might interfere with paint adhesion.
- B. Color Galvanizing:
  - 1. Product: Colorgalv system by Duncan Galvanizing.
  - 2. Description: Galvanizing as specified above, coated with plant-applied primer and top coat system complying with the following:
    - a. Primer: Provide factory-applied polyamide epoxy primer over specially prepared galvanized steel, 2.0 mils dry film thickness minimum, Primergalv by Duncan Galvanizing. Apply primer within 12 hours after galvanizing at the galvanizer's plant in a controlled environment meeting applicable environmental regulations, and as recommended by coating manufacturer.
    - b. High-Performance Architectural Finish: Provide factory-applied polyurethane coating, 2.5 mils dry film thickness minimum, architectural coating over primed galvanized steel, Colorgalv by Duncan Galvanizing. Apply coating at the galvanizer's plant immediately after application of the primer coat, in a controlled environment meeting applicable environmental regulations, and as recommended by coating manufacturer.
    - c. Color: As selected by Architect.
- C. Preparation for Shop Priming: Prepare surfaces to comply with requirements indicated below:
  - 1. Exterior Items (SSPC Zone 1B): SSPC-SP 6/NACE No. 3, "Commercial Blast Cleaning."
  - 2. Interiors (SSPC Zone 1A): SSPC-SP 3, "Power Tool Cleaning."

- D. Shop Priming: Apply shop primer to comply with SSPC-PA 1, "Paint Application Specification No. 1: Shop, Field, and Maintenance Painting of Steel," for shop painting.

- 1. Stripe paint corners,

crevices, bolts, welds, and sharp edges.

### PART 3 - EXECUTION

#### 3.1 INSTALLATION, GENERAL

- A. Cutting, Fitting, and Placement: Perform cutting, drilling, and fitting required for installing metal fabrications. Set metal fabrications accurately in location, alignment, and elevation; with edges and surfaces level, plumb, true, and free of rack; and measured from established lines and levels.
- B. Fit exposed connections accurately together to form hairline joints. Weld connections that are not to be left as exposed joints but cannot be shop welded because of shipping size limitations. Do not weld, cut, or abrade surfaces of exterior units that have been hot-dip galvanized after fabrication and are for bolted or screwed field connections.
- C. Field Welding: Comply with the following requirements:
  - 1. Use materials and methods that minimize distortion and develop strength and corrosion resistance of base metals.
  - 2. Obtain fusion without undercut or overlap.
  - 3. Remove welding flux immediately.
  - 4. At exposed connections, finish exposed welds and surfaces smooth and blended.
- D. Fastening to In-Place Construction: Provide anchorage devices and fasteners where metal fabrications are required to be fastened to in-place construction.
- E. Provide temporary bracing or anchors in formwork for items that are to be built into concrete, masonry, or similar construction.

#### 3.2 INSTALLING MISCELLANEOUS FRAMING AND SUPPORTS

- A. General: Install framing and supports to comply with requirements of items being supported, including manufacturers' written instructions and requirements indicated on Shop Drawings.

#### 3.3 ADJUSTING AND CLEANING

- A. Touchup Painting: Immediately after erection, clean field welds, bolted

connections, and abraded areas. Paint uncoated and abraded areas with the same material as used for shop painting to comply with SSPC-PA 1 for touching up shop-painted surfaces.

- B. Galvanized Surfaces: Clean field welds, bolted connections, and abraded areas and repair galvanizing to comply with ASTM A 780.
- C. Color-Galvanized Surfaces: Clean surfaces, repair galvanizing, and touch-up to blend with original coating.

END OF SECTION 055000

Issued for Construction

Verrill Dana Interior Renovations  
Portland, Maine  
Project No. 16001

SECTION 057310- GLAZED DECORATIVE METAL RAILINGS

PART 1 - GENERAL

1.1 SUMMARY

A. Section Includes:

1. Monolithic Tempered Glass Dry Glazed Railing Systems.

1.2 PERFORMANCE REQUIREMENTS

- A. Support distributed load of 50 pounds per linear foot, applied horizontally at right angles in any direction to the handrail.
- B. Support concentrated horizontal load of 200 pounds, applied in any direction at any point along the handrail system.
- C. Support 50 pounds on 1 square foot perpendicular to guard at any location.

1.3 ACTION SUBMITTALS

- A. Product Data: Submit Manufacturer's technical product data for railing components and accessories.
- B. Shop Drawings: Dimensioned drawings of guard/railing assemblies indicating the following:
  1. Elevations; include joint locations, transitions, and terminations.
  2. Details; include base, top, and connection details.
- C. Samples: Submit samples of Manufacturer's finishes (as selected by Architect.)

1.4 QUALITY ASSURANCE

- A. Components and installation are to be in accordance with state and local building codes.
- B. All components and fittings are furnished by the same manufacturer.

1.5 DELIVERY, STORAGE, AND HANDLING

- A. Deliver materials properly protected against damage to finished surfaces during transit.
- B. Inspect materials upon delivery for damage. Unless minor defects can be made to meet the Architect's specifications and satisfaction, damaged parts shall be removed and replaced.

- C. Store materials at building site under cover in dry location.

## PART 2 - PRODUCTS

### 2.1 MANUFACTURERS

- A. C.R. Laurence Co., Inc. (CRL). (Basis of Design “Taper-Loc” System).
- B. Manufacturers of equivalent products will be considered in accordance with provisions of Section 012500 – Substitution Procedures.

### 2.2 MATERIALS

- A. Aluminum Components: Conforming to ASTM B221/ASTM B221M, Alloy 6063-T52.

### 2.3 COMPONENTS

- A. Glazing: Fully tempered ASTM C 1048 Kind FT, Quality q3.
- B. Internal Rail Cap Connection Sleeves: Metal tube, material compatible with handrail cap material.
- C. Dry Glazing System: “Taper-Loc” system consisting of two tapers and one L-Setting Block.
- D. Shoe Base:
  - 1. Profile: B5G10D, 2-1/2 inches wide by 4-1/8 inches high rectangular cross-section. Designed to work with Taper-Loc dry glazed system with 1/2” monolithic tempered glass.
  - 2. Material: Aluminum 6063-T52.
  - 3. Base Cladding: Sheet metal cladding added to exposed shoe base sections. Adhere with double-sided tape and/or silicone adhesive. Provide end caps where ends of shoe base sections are exposed.: #304 Brushed Stainless Steel.
- E. Wood Cap Railing: 397CR 1-3/4 inches by 2-1/8 inches: Cherry
- F. Fasteners: Types and sizes indicated in shop drawings:
  - 1. For concrete attachment, hole size in base shoe shall be 9/16”, counter bore 7/8” x 1/2” depth, center-to-center spacing of holes is 12”. Use Hilti HSL3 Expansion Anchors 3-3/4”long.

### 2.4 FABRICATION



- A. Fabricate handrail assembly components to lengths and configurations complying with shop drawings.
- B. Machine joint edges smooth and plane to produce hairline seams when site assembled; supply concealed sleeve connectors for joints.
- C. Isolate dissimilar metals to prevent electrolytic action by applying primer to concealed surfaces of metal components.

### PART 3 - EXECUTION

#### 3.1 INSTALLATION, GENERAL

- A. Install guards/handrails in accordance with Manufacturer's recommended installation instructions and approved shop drawings.

#### 3.2 CLEANING

- A. Clean glazing surfaces after installation, complying with requirements contained in the Manufacturer's instructions. Remove excess glazing sealant compounds, dirt, or other substances.
- B. Remove protective film from metal surfaces.
- C. Clean railing surfaces with clean water and mild detergent. DO not use abrasive chemicals, detergents or other implements that may mar or gouge the material.

#### 3.3 PROTECTION

- A. Institute protective measures required throughout the remainder of construction period to ensure that all materials do not incur any damage or deterioration.
- B. Repair components damaged by subsequent construction activities in accordance with Manufacturer's recommendations; replace damaged components that cannot be repaired to Architect's acceptance.

END OF SECTION 057310

Issued for Construction

Verrill Dana Interior Renovations  
Portland, Maine  
Project No. 16001

## SECTION 061000 - ROUGH CARPENTRY

### PART 1 - GENERAL

#### 1.1 SUMMARY

A. Section Includes:

1. Framing with dimension lumber.
2. Wood blocking and nailers.
3. Wood furring and grounds.
4. Plywood backing panels.
5. Blocking for construction, accessories, and Owner-furnished items.

#### 1.2 ACTION SUBMITTALS

A. Product Data: For each type of process and factory-fabricated product.

1. Include data for wood-preservative treatment from chemical treatment manufacturer and certification by treating plant that treated materials comply with requirements

#### 1.3 INFORMATIONAL SUBMITTALS

A. Evaluation Reports: For the following, from ICC-ES:

1. Wood-preservative-treated wood.
2. Fire-retardant-treated wood.
3. Power-driven fasteners.
4. Powder-actuated fasteners.
5. Expansion anchors.

### PART 2 - PRODUCTS

#### 2.1 WOOD PRODUCTS, GENERAL

- A. Lumber: DOC PS 20 and applicable rules of grading agencies indicated. If no grading agency is indicated, provide lumber that complies with the applicable rules of any rules-writing agency certified by the ALSC Board of Review. Provide lumber graded by an agency certified by the ALSC Board of Review to inspect and grade lumber under the rules indicated.

1. Factory mark each piece of lumber with grade stamp of grading agency.

2. Provide dressed lumber, S4S, unless otherwise indicated.
- B. Maximum Moisture Content of Lumber: 19 percent unless otherwise indicated.

## 2.2 WOOD-PRESERVATIVE-TREATED LUMBER

- A. Preservative Treatment by Pressure Process: AWPA U1; Use Category UC2.
  1. Preservative Chemicals: Acceptable to authorities having jurisdiction and containing no arsenic or chromium. Do not use inorganic boron (SBX) for sill plates.
- B. Kiln-dry lumber after treatment to a maximum moisture content of 19 percent. Do not use material that is warped or that does not comply with requirements for untreated material.
- C. Mark lumber with treatment quality mark of an inspection agency approved by the ALSC Board of Review.
- D. Application: Treat all rough carpentry unless otherwise indicated.

## 2.3 FIRE-RETARDANT-TREATED MATERIALS

- A. General: Where fire-retardant-treated materials are indicated, use materials complying with requirements in this article, that are acceptable to authorities having jurisdiction, and with fire-test-response characteristics specified as determined by testing identical products per test method indicated by a qualified testing agency.
- B. Fire-Retardant-Treated Lumber and Plywood by Pressure Process: Products with a flame spread index of 25 or less when tested according to ASTM E 84, and with no evidence of significant progressive combustion when the test is extended an additional 20 minutes, and with the flame front not extending more than 10.5 feet beyond the Centerline of the burners at any time during the test.
  1. Interior Type A: Treated materials shall have a moisture content of 28 percent or less when tested according to ASTM D 3201 at 92 percent relative humidity. Use where exterior type is not indicated.
- C. Kilndry lumber after treatment to a maximum moisture content of 19 percent. Kilndry plywood after treatment to a maximum moisture content of 15 percent.
- D. Identify fire-retardant-treated wood with appropriate classification marking of qualified testing agency.
- E. Application: Treat items indicated on Drawings, and the following:
  1. Plywood backing panels.

## 2.4 DIMENSION LUMBER FRAMING

- A. Framing Other Than Non-Load-Bearing Interior Partitions: No. 2 grade.
  - 1. Application: Framing other than interior partitions.
  - 2. Species:
    - a. Spruce-pine-fir; NLGA.

## 2.5 MISCELLANEOUS LUMBER

- A. General: Provide miscellaneous lumber indicated and lumber for support or attachment of other construction, including the following:
  - 1. Blocking.
  - 2. Nailers.
  - 3. Furring.
- B. For items of dimension lumber size, provide Construction or No. 2 grade lumber of any species.
- C. For concealed boards, provide lumber with 15 percent maximum moisture content and the following species and grades:
  - 1. Northern species; No. 2 Common grade; NLGA.
- D. For blocking and nailers used for attachment of other construction, select and cut lumber to eliminate knots and other defects that will interfere with attachment of other work.

## 2.6 PLYWOOD BACKING PANELS

- A. Equipment Backing Panels: DOC PS 1, Exposure 1, C-D Plugged, in thickness indicated or, if not indicated, not less than 1/2-inch nominal thickness.

## 2.7 FASTENERS

- A. General: Provide fasteners of size and type indicated that comply with requirements specified in this article for material and manufacture.
  - 1. Where rough carpentry is exposed to weather, in ground contact, pressure-preservative treated, or in area of high relative humidity, provide fasteners with hot-dip zinc coating complying with ASTM A 153/A 153M.
- B. Power-Driven Fasteners: NES NER-272.

- C. Bolts: Steel bolts complying with ASTM A 307, Grade A; with ASTM A 563 hex nuts and, where indicated, flat washers.
- D. Nails, Brads, and Staples: ASTM F 1667.
- E. Power-Driven Fasteners: NES NER-272.
- F. Wood Screws: ASME B18.6.1.
- G. Lag Bolts: ASME B18.2.1 (ASME B18.2.3.8M).
- H. Bolts: Steel bolts complying with ASTM A 307, Grade A (ASTM F 568M, Property Class 4.6); with ASTM A 563 (ASTM A 563M) hex nuts and, where indicated, flat washers.
- I. Expansion Anchors: Anchor bolt and sleeve assembly of material indicated below with capability to sustain, without failure, a load equal to six times the load imposed when installed in unit masonry assemblies and equal to four times the load imposed when installed in concrete as determined by testing per ASTM E 488 conducted by a qualified independent testing and inspecting agency.
  - 1. Material: Carbonsteel components, zinc plated to comply with ASTM B 633, Class Fe/Zn 5.

## PART 3 - EXECUTION

### 3.1 INSTALLATION, GENERAL

- A. Set rough carpentry to required levels and lines, with members plumb, true to line, cut, and fitted. Fit rough carpentry to other construction; scribe and cope as needed for accurate fit. Locate furring, nailers, blocking, and similar supports to comply with requirements for attaching other construction.
- B. Framing Standard: Comply with AF&PA's WCD 1, "Details for Conventional Wood Frame Construction," unless otherwise indicated.
- C. Provide blocking and framing as indicated and as required to support facing materials, fixtures, specialty items, and trim.
- D. Sort and select lumber so that natural characteristics will not interfere with installation or with fastening other materials to lumber. Do not use materials with defects that interfere with function of member or pieces that are too small to use with minimum number of joints or optimum joint arrangement.
- E. Do not use panel materials with defects that impair quality of sheathing or pieces that are too small to use with minimum number of joints or optimum joint arrangement.
- F. Cut panels at penetrations, edges, and other obstructions of work; fit tightly

against abutting construction, unless otherwise indicated.

- G. Do not splice structural members between supports unless otherwise indicated.
- H. Securely attach rough carpentry work to Substrate by anchoring and fastening as indicated.
- I. Use steel common nails unless otherwise indicated. Select fasteners of size that will not fully penetrate members where opposite side will be exposed to view or will receive finish materials. Make tight connections between members. Install fasteners without splitting wood. Drive nails snug but do not countersink nail heads unless otherwise indicated.

### 3.2 WOOD BLOCKING AND NAILER INSTALLATION

- A. Install where indicated and where required for attaching other work. Install wood blocking and nailers to support construction and fixtures, including, but not limited to equipment services, heavy trim grab bars, toilet accessories, casework, furnishing, window treatment, handrail brackets, shelving, building specialties, window sills, drywall window return shims, countertop supports, Owner-furnished items, miscellaneous items, and construction. Provide 3/4-inch plywood covering a minimum of 32 inches square for toilet and medical accessories. Provide 1/2-inch thick blocking, minimum, for grab bars, door stops, and handrail supports. Form to shapes indicated and cut as required for true line and level of attached work. Coordinate locations with other work involved.
  - 1. Provide concealed wood blocking behind gypsum wallboard where door stops are to be installed.
- B. Attach items to Substrates to support applied loading. Recess bolts and nuts flush with surfaces unless otherwise indicated. Build anchor bolts into masonry during construction of masonry work. Where possible, secure anchor bolts to formwork before concrete placement.

END OF SECTION 061000

Issued for Construction

Verrill Dana Interior Renovations  
Portland, Maine  
Project No. 16001



## SECTION 064023 - INTERIOR ARCHITECTURAL WOODWORK

### PART 1 - GENERAL

#### 1.1 SUMMARY

- A. This Section includes the following:
  - 1. Interior standing and running trim.
  - 2. Wood cabinets.
  - 3. Wood wall paneling.
  - 4. Shelving and clothes rods.
  - 5. Plastic-laminate cabinets.
  - 6. Plastic-laminate countertops.
  - 7. Shop finishing of woodwork.
- B. Interior architectural woodwork includes wood furring, blocking, shims, and hanging strips unless concealed within other construction before woodwork installation.
- C. Rough carriages for stairs are a part of interior architectural woodwork. Platform framing, headers, partition framing, and other rough framing associated with stairwork are specified in Division 06 Section "Rough Carpentry."

#### 1.2 ACTION SUBMITTALS

- A. Product Data: For cabinet hardware and accessories, and finishing materials and processes.
- B. Shop Drawings: Show location of each item, dimensioned plans and elevations, large-scale details, attachment devices, and other components.
- C. Samples:
  - 1. Lumber and panel products for transparent finish, for each species and cut, finished on one side and one edge.
  - 2. Lumber and panel products with shop-applied opaque finish, for each finish system and color, with exposed surface finished.
  - 3. Plastic-laminates, for each type, color, pattern, and surface finish.
  - 4. Thermoset decorative panels, for each type, color, pattern, and surface finish.
  - 5. Shelving materials.

#### 1.3 INFORMATIONAL SUBMITTALS

- A. Woodwork Quality Standard Compliance Certificates: AWI Quality
- September 21, 2016                      064023 - 7                      INTERIOR ARCHITECTURAL WOODWORK

Certification Program certificates.

#### 1.4 QUALITY ASSURANCE

- A. Installer Qualifications: Fabricator of woodwork.
- B. Quality Standard: Unless otherwise indicated, comply with AWT's "Architectural Woodwork Quality Standards."

#### 1.5 PROJECT CONDITIONS

- A. Environmental Limitations: Do not deliver or install woodwork until building is enclosed, wet work is complete, and HVAC system is operating and maintaining temperature and relative humidity at occupancy levels during the remainder of the construction period.

### PART 2 - PRODUCTS

#### 2.1 MATERIALS

- A. Wood Species for Stain and Transparent Finish: WD-1 Black Cherry.
- B. Wood Species for Opaque Finish: Any closed-grain hardwood.
- C. Wood Products:
  - 1. Hardboard: AHA A135.4.
  - 2. Medium-Density Fiberboard: ANSI A208.2, Grade MD.
  - 3. Particleboard: ANSI A208.1, Grade M-2.
  - 4. Softwood Plywood: DOC PS 1.
  - 5. Veneer-Faced Panel Products (Hardwood Plywood): HPVA HP-1.
- D. Closet and Utility Adjustable Shelving: Provide the number of shelves indicated as follows:
  - 1. Shelves: Melamine-faced particleboard with applied 3 mm PVC front edge, matching face and 1 mm PVC applied to back edge and both ends; 3/4 inch thick.
  - 2. Adjustable shelf standards and supports: twin slotted, heavy duty, steel shelf standards and U-shaped, double-prong, heavy-duty steel brackets, powder coat finish, color selected by Architect.
    - a. Product: Steel-Lok, Spur Shelving.
- E. Exposed Shelf with Clothes Rod: As follows:
  - 1. Shelf: 3/4 inch thick MDO softwood plywood with solid-wood edge as detailed; opaque finish.
  - 2. Shelf cleats: 3/4-by-3-1/2-inch boards for opaque finish.

3. Rod: Stainless steel clad tubing, 1-1/16 inch diameter and steel closet pole sockets.
  - a. Rod: No 770 1, Knape & Vogt Mfg. Co.
  - b. Socket: No 764, Knape & Vogt Mfg. Co.
  
- F. High-Pressure Decorative Laminate: NEMA LD 3, grades as indicated or, if not indicated, as required by woodwork quality standard.
  1. Manufacturers: Subject to compliance with requirements, provide products by one of the following:
    - a. Wilsonart International; Div. of Premark International, Inc.
    - b. Or approved equal.
  2. PLAM - 1: WILLAMSBURG CHERRY 7936K-07
  3. PLAM - 2: WILSONART BEIGEWOOD 7850-60
  4. PLAM - 3: WILSONART RIO 7947K-18
  5. PLAM - 4: WILSONART GREY 1500-60
  6. PLAM - 5: NORTH SEA D90-60
  
- G. Coat Hooks: Smedbo 3 1/2 inch coat & hat hook SME-06758 polished chrome.
  1. Provide one hook on back of each single user toilet room door.
  2. Provide on walls in locations as shown on drawings.

## 2.2 CABINET HARDWARE AND ACCESSORIES

- A. General: Provide cabinet hardware and accessory materials associated with architectural woodwork, except for items specified in Division 08 Section "Door Hardware (Scheduled by Describing Products)."
- B. Frameless Concealed Hinges (European Type): BHMA A156.9, B01602, 135 degrees of opening, self-closing.
- C. Wire Pulls: Back mounted, solid metal, 4 inches long, 5/16 inch in diameter.
- D. Catches: Magnetic catches, BHMA A156.9, B03141.
- E. Drawer Slides: BHMA A156.9, B05091.
  1. Standard Duty (Grade 1, Grade 2, and Grade 3): Side mounted and extending under bottom edge of drawer; full-extension type; zinc-plated steel with polymer rollers.
  2. Heavy Duty (Grade 1HD-100 and Grade 1HD-200): Side mounted; full-extension type; zinc-plated steel ball-bearing slides.

3. Box Drawer Slides: Grade 1; for drawers not more than 6 inches high and 24 inches wide.
4. File Drawer Slides: Grade 1HD-100; for drawers more than 6 inches high or 24 inches wide.

F. Door Locks: BHMA A156.11, E07121.

G. Drawer Locks: BHMA A156.11, E07041.

H. Exposed Hardware Finishes: For exposed hardware, provide finish that complies with BHMA A156.18 for BHMA finish number indicated.

1. Satin Stainless Steel: BHMA 630.

## 2.3 MISCELLANEOUS MATERIALS

A. Furring, Blocking, Shims, and Hanging Strips: Softwood or hardwood lumber, kiln-dried to less than 15 percent moisture content.

B. Adhesives, General: Adhesives shall not contain urea formaldehyde.

C. VOC Limits for Installation Adhesives: Installation adhesives shall have a VOC content of 30 g/L or less when calculated according to 40 CFR 59, Subpart D (EPA Method 24).

## 2.4 FABRICATION

A. General: Complete fabrication to maximum extent possible before shipment to Project site.

Where necessary for fitting at site, provide allowance for scribing, trimming, and fitting.

1. Interior Woodwork Grade: Premium.
2. Shop cut openings to maximum extent possible. Sand edges of cutouts to remove splinters and burrs. Seal edges of openings in countertops with a coat of varnish.
3. Install glass to comply with applicable requirements in Division 08 Section "Glazing" and in GANA's "Glazing Manual." For glass in wood frames, secure glass with removable stops.

B. Interior Standing and Running Trim:

1. For transparent-finished trim items wider than available lumber, use veneered construction. Do not glue for width.
2. Backout or groove backs of flat trim members and kerf backs of other wide, flat members, except for members with ends exposed in finished work.
3. Assemble casings in plant except where limitations of access to

place of installation require field assembly.

- C. Fire-Rated Interior Frames and Jambs: Products fabricated from fire-retardant particleboard or fire-retardant medium-density fiberboard with veneered, exposed surfaces and listed and labeled by a testing and inspecting agency acceptable to authorities having jurisdiction, for fire ratings indicated, based on testing according to NFPA 252.
- D. Closet and Utility Shelving:
  - 1. Thickness: 3/4 inch thick.
  - 2. Shelf Cleats: 3/4-by-3-1/2-inch boards hardwood lumber trim for opaque finish.
- E. Plastic-Laminate Cabinets:
  - 1. AWI Type of Cabinet Construction: Flush overlay.
  - 2. Laminate Cladding for Exposed Surfaces: High-pressure decorative laminate as follows:
    - a. Horizontal Surfaces Other Than Tops: Grade HGS.
    - b. Postformed Surfaces: Grade HGP.
    - c. Vertical Surfaces: Grade HGS.
    - d. Edges: Grade HGS.
  - 3. Materials for Semiexposed Surfaces Other Than Drawer Bodies: High-pressure decorative laminate, Grade VGS.
  - 4. Drawer Sides and Backs: Solid-hardwood lumber.
  - 5. Drawer Bottoms: Hardwood plywood.
  - 6. Colors, Patterns, and Finishes: As selected by Architect from laminate manufacturer's full range of solid colors, matte finish.
- F. Plastic-Laminate Countertops:
  - 1. High-Pressure Decorative Laminate Grade: HGS.
  - 2. Edge Treatment: As indicated.
  - 3. Core Material at Sinks: Particleboard made with exterior glue.

## 2.5 SHOP FINISHING

- A. Finish architectural woodwork at fabrication shop. Defer only final touchup, cleaning, and polishing until after installation.
- B. Backpriming: Apply one coat of sealer or primer, compatible with finish coats, to concealed surfaces of woodwork. Apply two coats to back of paneling.
- C. Transparent Finish:

1. Grade: Custom.
2. AWI Finish System: Conversion varnish.
3. Staining: As approved by Architect to match existing.
4. Wash Coat for Stained Finish: Apply a wash-coat sealer to woodwork made from closed-grain wood before staining and finishing.
5. Open-Grain Woods: Do not apply filler to open-grain woods.
6. Sheen: Satin, 31-45 gloss units measured on 60-degree gloss meter per ASTM D 523.

## PART 3 - EXECUTION

### 3.1 INSTALLATION

- A. Before installation, condition woodwork to average prevailing humidity conditions in installation areas. Examine shop-fabricated work for completion and complete work as required, including removal of packing and backpriming.
- B. Grade: Install woodwork to comply with requirements for the same grade specified in Part 2 for fabrication of type of woodwork involved.
- C. Install woodwork level, plumb, true, and straight to a tolerance of 1/8 inch in 96 inches. Shim as required with concealed shims.
- D. Scribe and cut woodwork to fit adjoining work, refinish cut surfaces, and repair damaged finish at cuts.
- E. Anchor woodwork to anchors or blocking built in or directly attached to substrates. Secure with countersunk, concealed fasteners and blind nailing as required for complete installation. Use fine finishing nails or finishing screws for exposed fastening, countersunk and filled flush with woodwork and matching final finish if transparent finish is indicated.
- F. Standing and Running Trim: Install with minimum number of joints possible, using full-length pieces (from maximum length of lumber available) to greatest extent possible. Scarf running joints and stagger in adjacent and related members. Fill gaps, if any, between top of base and wall with plastic wood filler, sand smooth, and finish same as wood base if finished.
- G. Cabinets: Install without distortion so doors and drawers fit openings properly and are accurately aligned. Adjust hardware to center doors and drawers in openings and to provide unencumbered operation.
  1. Fasten wall cabinets through back, near top and bottom, at ends and not more than 16 inches o.c. with No. 10 wafer-head screws sized for 1-inch penetration into wood framing,

blocking, or hanging strips.

- H. Countertops: Anchor securely by screwing through corner blocks of base cabinets or other supports into underside of countertop. Calk space between backsplash and wall with sealant specified in Division 07 Section "Joint Sealants."
  
- I. Closet and Utility Shelving: Cut shelf cleats at ends of shelves about 1/2 inch (13 mm) less than width of shelves and sand exposed ends smooth. Install shelf cleats by fastening to framing or backing with finish nails or trim screws, set below face and filled. Space fasteners not more than 16 inches (400 mm) o.c. Cut shelves to neatly fit openings with only enough gap to allow shelves to be removed and reinstalled. Install shelves, fully seated on cleats, brackets, and supports.
  
- J. Clothes Rods: Install rod flanges for rods as indicated. Fasten to shelf cleats, framing members, blocking, or metal backing, or use toggle bolts or hollow wall anchors. Install rods in rod flanges.
  - K. Coat Hooks: Install plumb and level, in accordance with manufacturer's written instructions.

END OF SECTION 064023

Issued for Construction

Verrill Dana Interior Renovations  
Portland, Maine  
Project No. 16001



## SECTION 066400 - PLASTIC PANELING

### PART 1 - GENERAL

#### 1.1 SUMMARY

- A. Section includes glass-fiber reinforced plastic (FRP) wall paneling and trim accessories.

#### 1.2 ACTION SUBMITTALS

- A. Product Data: For each type of product indicated.
- B. Samples: For plastic paneling and trim accessories.

#### 1.3 QUALITY ASSURANCE

- A. Surface-Burning Characteristics: As determined by testing identical products according to ASTM E 84 by a qualified testing agency. Identify products with appropriate markings of applicable testing agency.
  - 1. Flame-Spread Index: 25 or less.
  - 2. Smoke-Developed Index: 450 or less.

### PART 2 - PRODUCTS

#### 2.1 PLASTIC SHEET PANELING

- A. General: Gelcoat-finished, glass-fiber reinforced plastic panels complying with ASTM D 5319.
  - 1. Manufacturers: Subject to compliance with requirements, provide products by one of the following:
    - a. Kemlite Company Inc.
    - b. Marlite.
    - c. Nudo Products, Inc.
  - 2. Nominal Thickness: Not less than 0.09 inch.
  - 3. Surface Finish: Smooth.
  - 4. Color: As selected by Architect from manufacturer's full range.

## 2.2 ACCESSORIES

- A. Trim Accessories: Manufacturer's standard one-piece vinyl extrusions designed to retain and cover edges of panels. Provide division bars, inside corners, outside corners, and caps as needed to conceal edges.
  - 1. Color: Match panels.
- B. Adhesive: As recommended by plastic paneling manufacturer.
- C. Sealant: Single-component, mildew-resistant, neutral-curing silicone sealant recommended by plastic paneling manufacturer and complying with requirements in Division 07 Section "Joint Sealants."

## PART 3 - EXECUTION

### 3.1 PREPARATION

- A. Clean substrates of substances that could impair bond of adhesive, including oil, grease, dirt, and dust.
- B. Condition panels by unpacking and placing in installation space before installation according to manufacturer's written recommendations.
- C. Lay out paneling before installing. Locate panel joints to provide equal panels at ends of walls not less than half the width of full panels.

### 3.2 INSTALLATION

- A. Install plastic paneling according to manufacturer's written instructions.
- B. Install panels in a full spread of adhesive.
- C. Install trim accessories with adhesive and nails or staples. Do not fasten through panels.
- D. Fill grooves in trim accessories with sealant before installing panels and bed inside corner trim in a bead of sealant.
- E. Maintain uniform space between panels and wall fixtures. Fill space with sealant.
- F. Remove excess sealant and smears as paneling is installed. Clean with solvent recommended by sealant manufacturer and then wipe with clean dry cloths until no residue remains.

## SECTION 078413 - PENETRATION FIRESTOPPING

### PART 1 - GENERAL

#### 1.1 SUMMARY

##### A. Section Includes:

1. Penetrations in fire-resistance-rated walls.
2. Penetrations in horizontal assemblies.
3. Penetrations in smoke barriers.

#### 1.2 ACTION SUBMITTALS

##### A. Product Data: For each type of product indicated.

##### B. Product Schedule: For each penetration firestopping system. Include location and design designation of qualified testing and inspecting agency.

1. Where Project conditions require modification to a qualified testing and inspecting agency's illustration for a particular penetration firestopping condition, submit illustration, with modifications marked, approved by penetration firestopping manufacturer's fire-protection engineer as an engineering judgment or equivalent fire-resistance-rated assembly.

#### 1.3 INFORMATIONAL SUBMITTALS

##### A. Installer Certificates: From Installer indicating penetration firestopping has been installed in compliance with requirements and manufacturer's written recommendations.

##### B. Product test reports.

#### 1.4 QUALITY ASSURANCE

##### A. Fire-Test-Response Characteristics: Penetration firestopping shall comply with the following requirements:

1. Penetration firestopping tests are performed by UL.
2. Penetration firestopping is identical to those tested per testing standard referenced in "Penetration Firestopping" Article. Provide rated systems bearing marking of qualified

testing and inspection agency.

- B. Preinstallation Conference: Conduct conference at Project site.

## PART 2 - PRODUCTS

### 2.1 MANUFACTURERS

- A. Manufacturers: Subject to compliance with requirements, provide products by one of the following:
  - 1. A/D Fire Protection Systems Inc.
  - 2. Grace Construction Products.
  - 3. Hilti, Inc.
  - 4. Johns Manville.
  - 5. Nelson Firestop Products.
  - 6. Specified Technologies Inc.
  - 7. 3M Fire Protection Products.
  - 8. Tremco, Inc.; Tremco Fire Protection Systems Group.
  - 9. USG Corporation.

### 2.2 PENETRATION FIRESTOPPING

- A. Provide penetration firestopping that is produced and installed to resist spread of fire according to requirements indicated, resist passage of smoke and other gases, and maintain original fire-resistance rating of construction penetrated. Penetration firestopping systems shall be compatible with one another, with the substrates forming openings, and with penetrating items if any.
- B. Penetrations in Fire-Resistance-Rated Walls: Ratings determined per ASTM E 814 or UL 1479, based on testing at a positive pressure differential of 0.01-inch wg.
  - 1. F-Rating: Not less than the fire-resistance rating of constructions penetrated.
- C. Accessories: Provide components for each penetration firestopping system that are needed to install fill materials and to maintain ratings required. Use only those components specified by penetration firestopping manufacturer and approved by qualified testing and inspecting agency for firestopping indicated.

## PART 3 - EXECUTION

### 3.1 INSTALLATION

- A. Examine substrates and conditions, with Installer present, for compliance with requirements for opening configurations, penetrating items,

substrates, and other conditions affecting performance of the Work.

- B. Install penetration firestopping to comply with manufacturer's written installation instructions and published drawings for products and applications indicated.
- C. Install forming materials and other accessories of types required to support fill materials during their application and in the position needed to produce cross-sectional shapes and depths required to achieve fire ratings indicated.
  - 1. After installing fill materials and allowing them to fully cure, remove combustible forming materials and other accessories not indicated as permanent components of firestopping.
- D. Install fill materials for firestopping by proven techniques to produce the following results:
  - 1. Fill voids and cavities formed by openings, forming materials, accessories, and penetrating items as required to achieve fire-resistance ratings indicated.
  - 2. Apply materials so they contact and adhere to substrates formed by openings and penetrating items.
  - 3. For fill materials that will remain exposed after completing the Work, finish to produce smooth, uniform surfaces that are flush with adjoining finishes.

### 3.2 FIELD QUALITY CONTROL

- A. Owner will engage a qualified testing agency to perform tests and inspections.
- B. Where deficiencies are found or penetration firestopping is damaged or removed because of testing, repair or replace penetration firestopping to comply with requirements.
- C. Proceed with enclosing penetration firestopping with other construction only after inspection reports are issued and installations comply with requirements.

### 3.3 PENETRATION FIRESTOPPING SCHEDULE

- A. Where UL-classified systems are indicated, they refer to system numbers in UL's "Fire Resistance Directory" under product Category XHEZ.
- B. Firestopping with No Penetrating Items:
  - 1. UL-Classified Systems: C-AJ-0001-0999.

- C. Firestopping for Metallic Pipes, Conduit, or Tubing:
  - 1. UL-Classified Systems: C-AJ-1001-1999.
- D. Firestopping for Nonmetallic Pipe, Conduit, or Tubing:
  - 1. UL-Classified Systems: C-AJ-2001-2999.
- E. Firestopping for Electrical Cables:
  - 1. UL-Classified Systems: C-AJ-3001-3999.
- F. Firestopping for Cable Trays with Electric Cables:
  - 1. UL-Classified Systems: C-AJ- 4001-4999.
- G. Firestopping for Insulated Pipes:
  - 1. UL-Classified Systems: C-AJ-5001-5999.
- H. Firestopping for Miscellaneous Electrical Penetrants:
  - 1. UL-Classified Systems: C-AJ-6001-6999.
- I. Firestopping for Miscellaneous Mechanical Penetrants:
  - 1. UL-Classified Systems: C-AJ-7001-7999.
- J. Firestopping for Groupings of Penetrants:
  - 1. UL-Classified Systems: C-AJ- 8001-8999. END OF

SECTION 078413

## SECTION 078446 - FIRE-RESISTIVE JOINT SYSTEMS

### PART 1 - GENERAL

#### 1.1 SUMMARY

A. Section Includes:

1. Joints in or between fire-resistance-rated constructions.

#### 1.2 ACTION SUBMITTALS

A. Product Data: For each type of product indicated.

B. Product Schedule: For each fire-resistive joint system. Include location and design designation of qualified testing agency.

1. Where Project conditions require modification to a qualified testing agency's illustration for a particular fire-resistive joint system condition, submit illustration, with modifications marked, approved by fire-resistive joint system manufacturer's fire-protection engineer as an engineering judgment or equivalent fire-resistance-rated assembly.

#### 1.3 INFORMATIONAL SUBMITTALS

A. Installer Certificates: From Installer indicating fire-resistive joint systems have been installed in compliance with requirements and manufacturer's written recommendations.

B. Product test reports.

#### 1.4 QUALITY ASSURANCE

A. Installer Qualifications: A firm that has been approved by FM Global according to FM Global 4991, "Approval of Firestop Contractors," or been evaluated by UL and found to comply with UL's "Qualified Firestop Contractor Program Requirements."

B. Fire-Test-Response Characteristics: Fire-resistive joint systems shall comply with the following requirements:

1. Fire-resistive joint system tests are performed by UL.

- C. Preinstallation Conference: Conduct conference at Project site.

## PART 2 - PRODUCTS

### 2.1 FIRE-RESISTIVE JOINT SYSTEMS

- A. Where required, provide fire-resistive joint systems that are produced and installed to resist spread of fire according to requirements indicated, resist passage of smoke and other gases, and maintain original fire-resistance rating of assemblies in or between which fire-resistive joint systems are installed. Fire-resistive joint systems shall accommodate building movements without impairing their ability to resist the passage of fire and hot gases.
- B. Joints in or between Fire-Resistance-Rated Construction: Ratings determined per ASTM E 1966 or UL 2079:
  - 1. Fire-Resistance Rating: Equal to or exceeding the fire-resistance rating of construction they will join.
  - 2. Manufacturers: Subject to compliance with requirements, provide products by one of the following:
    - a. A/D Fire Protection Systems Inc.
    - b. Fire Trak Corp.
    - c. Grace Construction Products.
    - d. Hilti, Inc.
    - e. Johns Manville.
    - f. Nelson Firestop Products.
    - g. Specified Technologies Inc.
    - h. 3M Fire Protection Products.
    - i. Tremco, Inc.; Tremco Fire Protection Systems Group.
    - j. USG Corporation.
- C. Accessories: Provide components of fire-resistive joint systems, including primers and forming materials, that are needed to install fill materials and to maintain ratings required. Use only components specified by fire-resistive joint system manufacturer and approved by the qualified testing agency for systems indicated.

## PART 3 - EXECUTION

### 3.1 INSTALLATION

- A. Examine substrates and conditions, with Installer present, for compliance with requirements for joint configurations, substrates, and other conditions affecting performance of the Work.
- B. Install fire-resistive joint systems to comply with manufacturer's written installation instructions and published drawings for products and applications



indicated.

C. Install forming materials and other accessories of types required to support fill materials during their application and in position needed to produce cross-sectional shapes and depths required to achieve fire ratings indicated..

1. After installing fill materials and allowing them to fully cure, remove combustible forming materials and other accessories not indicated as permanent components of fire-resistive joint system.
- D. Install fill materials for fire-resistive joint systems by proven techniques to produce the following results:
1. Fill voids and cavities formed by joints and forming materials as required to achieve fire-resistance ratings indicated.
  2. Apply fill materials so they contact and adhere to substrates formed by joints.
  3. For fill materials that will remain exposed after completing the Work, finish to produce smooth, uniform surfaces that are flush with adjoining finishes.

### 3.2 IDENTIFICATION

- A. Identify fire-resistive joint systems with preprinted metal or plastic labels. Attach labels permanently to surfaces adjacent to and within 6 inches of joint edge so labels will be visible to anyone seeking to remove or penetrate joint system. Use mechanical fasteners or self-adhering-type labels with adhesives capable of permanently bonding labels to surfaces on which labels are placed. Include the following information on labels:
1. The words "Warning - Fire-Resistive Joint System - Do Not Disturb. Notify Building Management of Any Damage."
  2. Contractor's name, address, and phone number.
  3. Designation of applicable testing agency.
  4. Date of installation.
  5. Manufacturer's name.
  6. Installer's name.

### 3.3 FIELD QUALITY CONTROL

- A. Inspecting Agency: Owner will engage a qualified testing agency to perform tests and inspections.
- B. Where deficiencies are found or fire-resistive joint systems are damaged or removed due to testing, repair or replace fire-resistive joint systems so they comply with requirements.
- C. Proceed with enclosing fire-resistive joint systems with other construction only after inspection reports are issued and installations comply with requirements.

3.4 FIRE-RESISTIVE JOINT SYSTEM SCHEDULE

- A. Where UL-classified systems are indicated, they refer to system numbers in UL's "Fire Resistance Directory" under product Category XHBN.
- B. Floor-to-Floor, Fire-Resistive Joint Systems:
  - 1. UL-Classified Systems: FF-D-0000-0999.
- C. Wall-to-Wall, Fire-Resistive Joint Systems:
  - 1. UL-Classified Systems: WW-D-0000-0999.
- D. Floor-to-Wall, Fire-Resistive Joint Systems:
  - 1. UL-Classified Systems: FW-D-0000-0999.
- E. Head-of-Wall, Fire-Resistive Joint Systems:
  - 1. UL-Classified Systems: HW-D-0000-0999.
- F. Bottom-of-Wall, Fire-Resistive Joint Systems:
  - 1. UL-Classified Systems: BW-D-0000-0999.
- G. Wall-to-Wall, Fire-Resistive Joint Systems Intended for Use as Corner Guards:
  - 1. UL-Classified Systems: CG-D-0000-0999.

END OF SECTION 078446

## SECTION 079200 - JOINT SEALANTS

### PART 1 - GENERAL

#### 1.1 SUMMARY

- A. Section Includes:
  - 1. Silicone joint sealants.
  - 2. Urethane joint sealants.
  - 3. Latex joint sealants.
  - 4. Acoustical joint sealants.

#### 1.2 PRECONSTRUCTION TESTING

- A. Preconstruction Compatibility and Adhesion Testing: Submit to joint-sealant manufacturers eight samples of materials that will contact or affect joint sealants. Use ASTM C 1087 to determine whether priming and other specific joint preparation techniques are required to obtain rapid, optimum adhesion of joint sealants to joint substrates.

#### 1.3 ACTION SUBMITTALS

- A. Product Data: For each joint-sealant product indicated.
- B. Samples: For each kind and color of joint sealant required.
- C. Joint-Sealant Schedule: Include the following information:
  - 1. Joint-sealant application, joint location, and designation.
  - 2. Joint-sealant manufacturer and product name.
  - 3. Joint-sealant formulation.
  - 4. Joint-sealant color.

#### 1.4 INFORMATIONAL SUBMITTALS

- A. Product test reports.
- B. Preconstruction compatibility and adhesion test reports.
- C. Warranties.

## 1.5 QUALITY ASSURANCE

- A. Testing Agency Qualifications: Qualified according to ASTM C 1021 to conduct the testing indicated.
- B. Preinstallation Conference: Conduct conference at Project site.

## 1.6 WARRANTY

- A. Special Installer's Warranty: Manufacturer's standard form in which Installer agrees to repair or replace joint sealants that do not comply with performance and other requirements specified in this Section within specified warranty period.

- 1. Warranty Period: Two years from

date of Substantial Completion.

## PART 2 - PRODUCTS

### 2.1 MATERIALS, GENERAL

- A. Liquid-Applied Joint Sealants: Comply with ASTM C 920 and other requirements indicated for each liquid-applied joint sealant specified, including those referencing ASTM C 920 classifications for type, grade, class, and uses related to exposure and joint substrates.
  - 1. Suitability for Immersion in Liquids. Where sealants are indicated for Use I for joints that will be continuously immersed in liquids, provide products that have undergone testing according to ASTM C 1247. Liquid used for testing sealants is deionized water, unless otherwise indicated.
- B. Stain-Test-Response Characteristics: Where sealants are specified to be nonstaining to porous substrates, provide products that have undergone testing according to ASTM C 1248 and have not stained porous joint substrates indicated for Project.

### 2.2 SILICONE JOINT SEALANTS

- A. Mildew-Resistant Silicone Joint Sealant, Type 4: ASTM C 920.
  - 1. Manufacturers: Subject to compliance with requirements, provide products by one of the following:
    - a. Dow Corning Corporation.
    - b. GE Advanced Materials - Silicones.
    - c. Pecora Corporation.
    - d. Tremco Incorporated.

2. Type: Multicomponent (M).
3. Grade: Nonsag (NS).
4. Class: 25.
5. Uses Related to Exposure: Nontraffic (NT).

## 2.3 URETHANE JOINT SEALANTS

### A. Urethane Joint Sealant, Type 1: ASTM C 920.

1. Manufacturers: Subject to compliance with requirements, provide products by one of the following:
  - a. BASF Building Systems.
  - b. Bostik, Inc.
  - c. Pecora Corporation.
  - d. Sika Corporation; Construction Products Division.
  - e. Tremco Incorporated.
2. Type: Single component (S) M.
3. Grade: Nonsag (NS).
4. Class: 25.
5. Uses Related to Exposure: Traffic (T).

### B. Urethane Joint Sealant, Type 2: ASTM C 920.

1. Manufacturers: Subject to compliance with requirements, provide products by one of the following:
  - a. BASF Building Systems.
  - b. Bostik, Inc.
  - c. Pecora Corporation.
  - d. Sika Corporation; Construction Products Division.
  - e. Tremco Incorporated.
2. Type: Multicomponent (M).
3. Grade: Nonsag (NS).
4. Class: 25.
5. Uses Related to Exposure: Traffic (T).

### C. Urethane Joint Sealant, Type 6: ASTM C 920.

1. Manufacturers: Subject to compliance with requirements, provide products by one of the following:
  - a. BASF Building Systems.
  - b. Bostik, Inc.
  - c. Pecora Corporation.
  - d. Sika Corporation; Construction Products Division.
  - e. Tremco Incorporated.

2. Type: Multicomponent (M).
3. Grade: Pourable (P).
4. Class: 25.
5. Uses Related to Exposure: Traffic (T).

#### 2.4 LATEX JOINT SEALANTS

- A. Latex Joint Sealant, Type 3: Acrylic latex or siliconized acrylic latex, ASTM C 834, Type OP, Grade NF.
  1. Manufacturers: Subject to compliance with requirements, provide products by one of the following:
    - a. Bostik, Inc.
    - b. Pecora Corporation.
    - c. Tremco Incorporated.

#### 2.5 ACOUSTICAL JOINT SEALANTS

- A. Acoustical Joint Sealant, Type 5: Manufacturer's standard nonsag, paintable, nonstaining latex sealant complying with ASTM C 834. Product effectively reduces airborne sound transmission through perimeter joints and openings in building construction as demonstrated by testing representative assemblies according to ASTM E 90.
  1. Manufacturers: Subject to compliance with requirements, provide products by one of the following:
    - a. Pecora Corporation.
    - b. USG Corporation.

#### 2.6 JOINT SEALANT BACKING

- A. General: Provide sealant backings of material that are nonstaining; are compatible with joint substrates, sealants, primers, and other joint fillers; and are approved for applications indicated by sealant manufacturer based on field experience and laboratory testing.
- B. Cylindrical Sealant Backings: ASTM C 1330, Type C (closed-cell material with a surface skin),, and of size and density to control sealant depth and otherwise contribute to producing optimum sealant performance.
- C. Bond-Breaker Tape: Polyethylene tape or other plastic tape recommended by sealant manufacturer.

## 2.7 MISCELLANEOUS MATERIALS

- A. Primer: Material recommended by joint-sealant manufacturer where required for adhesion of sealant to joint substrates indicated, as determined from preconstruction joint-sealant-substrate tests and field tests.
- B. Cleaners for Nonporous Surfaces: Chemical cleaners acceptable to manufacturers of sealants and sealant backing materials.
- C. Masking Tape: Nonstaining, nonabsorbent material compatible with joint sealants and surfaces adjacent to joints.

## PART 3 - EXECUTION

### 3.1 PREPARATION

- A. Surface Cleaning of Joints: Clean out joints immediately before installing joint sealants to comply with joint-sealant manufacturer's written instructions.
  - 1. Remove laitance and form-release agents from concrete.
  - 2. Clean nonporous joint substrate surfaces with chemical cleaners or other means that do not stain, harm substrates, or leave residues capable of interfering with adhesion of joint sealants.
- B. Joint Priming: Prime joint substrates where recommended by joint-sealant manufacturer or as indicated by preconstruction joint-sealant-substrate tests or prior experience. Apply primer to comply with joint-sealant manufacturer's written instructions. Confine primers to areas of joint-sealant bond; do not allow spillage or migration onto adjoining surfaces.
- C. Masking Tape: Use masking tape where required to prevent contact of sealant or primer with adjoining surfaces that otherwise would be permanently stained or damaged by such contact or by cleaning methods required to remove sealant smears. Remove tape immediately after tooling without disturbing joint seal.

### 3.2 INSTALLATION

- A. Sealant Installation Standard: Comply with recommendations in ASTM C 1193 for use of joint sealants as applicable to materials, applications, and conditions indicated.
- B. Install sealant backings of kind indicated to support sealants during application and at position required to produce cross-sectional shapes and depths of installed sealants relative to joint widths that allow optimum sealant movement capability.
  - 1. Do not leave gaps between ends of sealant backings.
  - 2. Do not stretch, twist, puncture, or tear sealant backings.
  - 3. Remove absorbent sealant backings that have become wet before sealant

application and replace them with dry materials.

- C. Install bond-breaker tape behind sealants where sealant backings are not used between sealants and backs of joints.
- D. Install sealants using proven techniques that comply with the following and at the same time backings are installed:
  - 1. Place sealants so they directly contact and fully wet joint substrates.
  - 2. Completely fill recesses in each joint configuration.
  - 3. Produce uniform, cross-sectional shapes and depths relative to joint widths that allow optimum sealant movement capability.
- E. Tooling of Nonsag Sealants: Immediately after sealant application and before skinning or curing begins, tool sealants according to requirements specified in subparagraphs below to form smooth, uniform beads of configuration indicated; to eliminate air pockets; and to ensure contact and adhesion of sealant with sides of joint.
  - 1. Remove excess sealant from surfaces adjacent to joints.
  - 2. Use tooling agents that are approved in writing by sealant manufacturer and that do not discolor sealants or adjacent surfaces.
  - 3. Provide concave joint profile per Figure 8A in ASTM C 1193, unless otherwise indicated.
- F. Acoustical Sealant Installation: Comply with ASTM C 919 and with manufacturer's written recommendations.
- G. Clean off excess sealant or sealant smears adjacent to joints as the Work progresses by methods and with cleaning materials approved in writing by manufacturers of joint sealants and of products in which joints occur.

### 3.3 FIELD QUALITY CONTROL

- A. Field-Adhesion Testing: Field test joint-sealant adhesion to joint substrates as follows:
  - 1. Extent of Testing: Test completed and cured sealant joints as follows:
    - a. Perform 10 tests for the first 1000 feet of joint length for each kind of sealant and joint substrate.
    - b. Perform 1 test for each 1000 feet of joint length thereafter or 1 test per each floor per elevation.
  - 2. Test Method: Test joint sealants according to Method A, Field-Applied Sealant Joint Hand Pull Tab, in Appendix X1 in ASTM C 1193 or Method A, Tail Procedure, in ASTM C 1521.
- B. Evaluation of Field-Adhesion Test Results: Sealants not evidencing adhesive failure from testing or noncompliance with other indicated requirements will



be considered satisfactory.

Remove sealants that fail to adhere to joint substrates during testing or to comply with other requirements. Retest failed applications until test results prove sealants comply with indicated requirements.

### 3.4 JOINT-SEALANT SCHEDULE

- A. Joint-Sealant Application: Concealed interior perimeter joints of exterior openings.
  - 1. Joint Sealant: Type 1.
  - 2. Joint-Sealant Color: As selected by Architect from manufacturer's full range of colors.
  
- B. Joint-Sealant Application: Exposed interior perimeter joints of exterior openings.
  - 1. Joint Sealant: Type 2.
  - 2. Joint-Sealant Color: As selected by Architect from manufacturer's full range of colors.
  
- C. Joint-Sealant Application: Joints between plumbing fixtures and walls and floors between countertops and walls.
  - 1. Joint Sealant: Type 4.
  - 2. Joint-Sealant Color: As selected by Architect from manufacturer's full range of colors.
  
- D. Joint-Sealant Application: Acoustical joints, where indicated.
  - 1. Joint Sealant: Type 5.
  - 2. Joint-Sealant Color: As selected by Architect from manufacturer's full range of colors.

END OF SECTION 079200

Issued for Construction

Verrill Dana Interior Renovations  
Portland, Maine  
Project No. 16001

## SECTION 081113 - HOLLOW METAL DOORS AND FRAMES

### PART 1 - GENERAL

#### 1.1 SUMMARY

- A. Section Includes:
  - 1. Standard hollow metal frames.

#### 1.2 ACTION SUBMITTALS

- A. Product Data: For each type of product indicated.
- B. Shop Drawings: Include elevations, frame profiles, metal thicknesses, preparations for hardware, and other details.
- C. Samples for Initial Selection: For units with factory-applied color finishes.
- D. Samples for Verification: For each type of exposed finish required.
- E. Schedule: Prepared by or under the supervision of supplier, using same reference numbers for details and openings as those on Drawings.

#### 1.3 QUALITY ASSURANCE

- A. Fire-Rated Door Assemblies: Assemblies complying with NFPA 80 that are listed and labeled by a qualified testing agency, for fire-protection ratings indicated, based on testing at positive pressure according to NFPA 252.

### PART 2 - PRODUCTS

#### 2.1 MANUFACTURERS

- A. Manufacturers: Subject to compliance with requirements, provide products by one of the following:
  - 1. Amweld Building Products, LLC.
  - 2. Ceco Door Products; an Assa Abloy Group company.
  - 3. Curries Company; an Assa Abloy Group company.
  - 4. Pioneer Industries, Inc.
  - 5. Steelcraft; an Ingersoll-Rand company.
  - 6. Windsor Republic Doors.

## 2.2 MATERIALS

- A. Metallic-Coated Steel Sheet: ASTM A 653/A 653M, Commercial Steel (CS), Type B; with minimum A40 metallic coating.
- B. Frame Anchors: ASTM A 591/A 591M, Commercial Steel (CS), 40Z coating designation; mill phosphatized.
  - 1. For anchors built into exterior walls, steel sheet complying with ASTM A 1008/A 1008M or ASTM A 1011/A 1011M, hot-dip galvanized according to ASTM A 153/A 153M, Class B.
- C. Inserts, Bolts, and Fasteners: Hot-dip galvanized according to ASTM A 153/A 153M.
- D. Grout: ASTM C 476, except with a maximum slump of 4 inches, as measured according to ASTM C 143/C 143M.
- E. Mineral-Fiber Insulation: ASTM C 665, Type I.
- F. Bituminous Coating: Cold-applied asphalt mastic, SSPC-Paint 12, compounded for 15-mil dry film thickness per coat.

## 2.3 HOLLOW METAL FRAMES

- A. General: Comply with ANSI/SDI A250.8.
- B. Profiles and sizes as shown on drawings.
- C. Interior Frames: Fabricated from cold-rolled steel sheet unless metallic-coated sheet is indicated.
  - 1. Fabricate frames with mitered or coped corners.
  - 2. Fabricate frames as knocked down unless otherwise indicated.
  - 3. Frames for Wood Doors: 0.042-inch-thick steel sheet.
- D. Hardware Reinforcement: ANSI/SDI A250.6.

## 2.4 FRAME ANCHORS

- A. Jamb Anchors:
  - 1. Masonry Type: Adjustable strap-and-stirrup or T-shaped anchors to suit frame size, not less than 0.042 inch thick, with corrugated or perforated straps not less than 2 inches wide by 10 inches long; or wire anchors not less than 0.177 inch thick.
- B. Floor Anchors: Formed from same material as frames, not less than 0.042 inch thick, and as follows:
  - 1. Monolithic Concrete Slabs: Clip-type anchors, with two holes to receive fasteners.

## 2.5 FABRICATION

- A. Tolerances: Fabricate hollow metal work to tolerances indicated in SDI 117.
- B. Hollow Metal Frames: Where frames are fabricated in sections, provide alignment plates or angles at each joint, fabricated of same thickness metal as frames.
  - 1. Welded Frames: Weld flush face joints continuously; grind, fill, dress, and make smooth, flush, and invisible.
  - 2. Provide countersunk, flat- or oval-head exposed screws and bolts for exposed fasteners unless otherwise indicated.
  - 3. Grout Guards: Weld guards to frame at back of hardware mortises in frames to be grouted.
  - 4. Floor Anchors: Weld anchors to bottom of jambs and mullions with at least four spot welds per anchor.
  - 5. Jamb Anchors: Provide number and spacing of anchors as follows:
    - a. Masonry Type: Locate anchors not more than 18 inches from top and bottom of frame. Space anchors not more than 32 inches o.c. and as follows:
      - 1) Three anchors per jamb from 60 to 90 inches high.
- C. Hardware Preparation: Factory prepare hollow metal work to receive templated mortised hardware according to the Door Hardware Schedule and templates furnished as specified in Division 08 Section "Door Hardware."
  - 1. Locate hardware as indicated, or if not indicated, according to ANSI/SDI A250.8.
  - 2. Reinforce doors and frames to receive nontemplated, mortised and surface-mounted door hardware.
  - 3. Comply with applicable requirements in ANSI/SDI A250.6 and ANSI/DHI A115 Series specifications for preparation of hollow metal work for hardware.
  - 4. Coordinate locations of conduit and wiring boxes for electrical connections with Division 26 electrical Sections.

## 2.6 STEEL FINISHES

- A. Prime Finish: Apply manufacturer's standard primer immediately after cleaning and pretreating.
  - 1. Shop Primer: ANSI/SDI A250.10.

## PART 3 - EXECUTION

### 3.1 INSTALLATION

- A. Hollow Metal Frames: Comply with ANSI/SDI A250.11.

1. Set frames accurately in position, plumbed, aligned, and braced securely until permanent anchors are set. After wall construction is complete, remove temporary braces, leaving surfaces smooth and undamaged.
  - a. At fire-protection-rated openings, install frames according to NFPA 80.
  - b. Where frames are fabricated in sections because of shipping or handling limitations, field splice at approved locations by welding face joint continuously; grind, fill, dress, and make splice smooth, flush, and invisible on exposed faces.
  - c. Install door silencers in frames before grouting.
  - d. Remove temporary braces necessary for installation only after frames have been properly set and secured.
  - e. Check plumbness, squareness, and twist of frames as walls are constructed. Shim as necessary to comply with installation tolerances.
  - f. Field apply bituminous coating to backs of frames that are filled with grout containing antifreezing agents.
2. Floor Anchors: Provide floor anchors for each jamb and mullion that extends to floor, and secure with postinstalled expansion anchors.
  - a. Floor anchors may be set with powder-actuated fasteners instead of postinstalled expansion anchors if so indicated and approved on Shop Drawings.
3. Masonry Walls: Coordinate installation of frames to allow for solidly filling space between frames and masonry with grout.
4. Concrete Walls: Solidly fill space between frames and concrete with grout. Take precautions, including bracing frames, to ensure that frames are not deformed or damaged by grout forces.
5. Installation Tolerances: Adjust hollow metal door frames for squareness, alignment, twist, and plumb to the following tolerances:
  - a. Squareness: Plus or minus 1/16 inch, measured at door rabbet on a line 90 degrees from jamb perpendicular to frame head.
  - b. Alignment: Plus or minus 1/16 inch, measured at jambs on a horizontal line parallel to plane of wall.
  - c. Twist: Plus or minus 1/16 inch, measured at opposite face corners of jambs on parallel lines, and perpendicular to plane of wall.
  - d. Plumbness: Plus or minus 1/16 inch, measured at jambs at floor.

### 3.2 ADJUSTING AND CLEANING

- A. Prime-Coat Touchup: Immediately after erection, sand smooth rusted or damaged areas of prime coat and apply touchup of compatible air-drying, rust-inhibitive primer.

END OF SECTION 081113

## SECTION 081416 - FLUSH WOOD DOORS

### PART 1 - GENERAL

#### 1.1 SUMMARY

A. Section Includes:

1. Solid-core doors with wood-veneer faces.
2. Factory finishing flush wood doors.

B. Related Sections:

1. Division 08 Section "Glazing" for glass view panels in flush wood doors.

#### 1.2 ACTION SUBMITTALS

A. Product Data: For each type of door indicated. Include factory-finishing specifications.

B. Shop Drawings: Indicate location, size, and hand of each door; elevation of each kind of door; construction details not covered in Product Data; location and extent of hardware blocking; and other pertinent data.

1. Indicate dimensions and locations of mortises and holes for hardware.
2. Indicate dimensions and locations of cutouts.
3. Indicate requirements for veneer matching.
4. Indicate fire-protection ratings for fire-rated doors.

#### 1.3 QUALITY ASSURANCE

A. Quality Standard: In addition to requirements specified, comply with AWI's "Architectural Woodwork Quality Standards Illustrated."

B. Fire-Rated Wood Doors: Doors complying with NFPA 80 that are listed and labeled by a qualified testing agency, for fire-protection ratings indicated, based on testing at positive pressure according to NFPA 252.

### PART 2 - PRODUCTS

#### 2.1 MANUFACTURERS

A. Manufacturers: Subject to compliance with requirements, provide products by one of the following:

1. Algoma Hardwoods, Inc.
2. Buell Door Company Inc.
3. Eggers Industries.
4. Graham; an Assa Abloy Group company.
5. Ideal Architectural Doors & Plywood.
6. Mohawk Flush Doors, Inc.; a Masonite company.
7. VT Industries Inc.

## 2.2 DOOR CONSTRUCTION, GENERAL

### A. Particleboard-Core Doors:

1. Provide doors with either glued-wood-stave or structural-composite-lumber cores instead of particleboard cores for doors indicated to receive exit devices.

### B. Fire-Protection-Rated Doors: Provide core specified or mineral core as needed to provide fire-protection rating indicated.

1. Edge Construction: Provide edge construction with intumescent seals concealed by outer stile. Comply with specified requirements for exposed edges.
2. Pairs: Provide fire-retardant stiles that are listed and labeled for applications indicated without formed-steel edges and astragals. Provide stiles with concealed intumescent seals. Comply with specified requirements for exposed edges.

## 2.3 VENEERED-FACED DOORS

### A. Interior Solid-Core Doors:

1. Grade: Premium, with Grade A faces.
2. Species: American Cherry (*prunus serotina*).
3. Cut: Plain cut.
4. Match between Veneer Leaves: Book match.
5. Assembly of Veneer Leaves on Door Faces: Running match.
6. Core: Particleboard.
7. Construction: Five or seven plies. Stiles and rails are bonded to core, then entire unit abrasive planed before veneering.

## 2.4 LOUVERS AND LIGHT FRAMES

### A. Metal Louvers:

1. Metal and Finish: Extruded aluminum with Class II, clear anodic finish, AA-M12C22A31.

### B. Wood-Veneered Beads for Light Openings in Fire-Rated Doors: Manufacturer's standard wood-veneered noncombustible beads matching veneer species of door faces and approved for



use in doors of fire-protection rating indicated. Include concealed metal glazing clips where required for opening size and fire-protection rating indicated.

- C. Metal Frames for Light Openings in Fire-Rated Doors: Manufacturer's standard frame formed of 0.048-inch-thick, cold-rolled steel sheet; factory primed for paint finish; and approved for use in doors of fire-protection rating indicated.

## 2.5 FABRICATION

- A. Factory fit doors to suit frame-opening sizes indicated. Comply with clearance requirements of referenced quality standard for fitting unless otherwise indicated.
  - 1. Comply with requirements in NFPA 80 for fire-rated doors.
- B. Openings: Cut and trim openings through doors in factory.
  - 1. Light Openings: Trim openings with moldings of material and profile indicated.
  - 2. Glazing: Factory install glazing in doors indicated to be factory finished. Comply with applicable requirements in Division 08 Section "Glazing."
  - 3. Louvers: Factory install louvers in prepared openings.

## 2.6 FACTORY FINISHING

- A. Transparent Finish:
  - 1. Grade: Custom.
  - 2. Finish: AWI catalyzed polyurethane system.
  - 3. Staining: As approved by architect to match existing finishes.
  - 4. Effect: Filled finish.
  - 5. Sheen: Satin.

## PART 3 - EXECUTION

### 3.1 INSTALLATION

- A. Hardware: For installation, see Division 08 Section "Door Hardware."
- B. Installation Instructions: Install doors to comply with manufacturer's written instructions and the referenced quality standard, and as indicated.
  - 1. Install fire-rated doors in corresponding fire-rated frames according to NFPA 80.
- C. Job-Fitted Doors: Align and fit doors in frames with uniform clearances and bevels; do not trim stiles and rails in excess of limits set by manufacturer or permitted for fire-rated doors. Machine doors for hardware. Seal edges of doors, edges of cutouts, and mortises after fitting

and machining.

1. Clearances: Provide 1/8 inch at heads, jambs, and between pairs of doors. Provide 1/8 inch from bottom of door to top of decorative floor finish or covering unless otherwise indicated. Where threshold is shown or scheduled, provide 1/4 inch from bottom of door to top of threshold unless otherwise indicated.
  - a. Comply with NFPA 80 for fire-rated doors.
- D. Factory-Fitted Doors: Align in frames for uniform clearance at each edge.
- E. Factory-Finished Doors: Restore finish before installation if fitting or machining is required at Project site.

END OF SECTION 081416

## SECTION 081433 – STILE AND RAIL WOOD DOORS

### PART 1 - GENERAL

#### 1.4 SUMMARY

A. Section Includes:

1. Stile and rail wood doors with wood-veneer faces.
2. Factory finishing of wood doors.

B. Related Sections:

1. Division 08 Section "Glazing" for glass view panels in stile and rail wood doors.

#### 1.5 ACTION SUBMITTALS

A. Product Data: For each type of door indicated. Include factory-finishing specifications.

B. Shop Drawings: Indicate location, size, and hand of each door; elevation of each kind of door; construction details not covered in Product Data; location and extent of hardware blocking; and other pertinent data.

1. Indicate dimensions and locations of mortises and holes for hardware.
2. Indicate dimensions and locations of cutouts.
3. Indicate requirements for veneer matching.
4. Indicate fire-protection ratings for fire-rated doors.

C. Verification Samples: Submit two corner samples, minimum 12 inches by 12 inches representing actual products and materials specified indicating door construction, panel and sticking details, visual characteristics, and finish. Include range of samples if variation of appearance is anticipated.

D. Warranty: Submit manufacturer's standard warranty.

#### 1.6 QUALITY ASSURANCE

A. Quality Standard: In addition to requirements specified, comply with AWI's "Architectural Woodwork Quality Standards Illustrated."

B. Manufacturer's Qualifications: Company specializing in manufacturing doors with a minimum of five years documented experience.

C. Single Source Requirements: To the greatest extent practical, wood doors shall be supplied from a single manufacturer.

D. Project Conditions: Maintain environmental conditions (temperature, humidity, and ventilation) within limits recommended by manufacturer for optimum results. Do not install products under environmental conditions outside manufacturer's recommended limits.

- E. Fire-Rated Wood Doors: Doors complying with NFPA 80 that are listed and labeled by a qualified testing agency, for fire-protection ratings indicated, based on testing at positive pressure according to NFPA 252.

#### 1.7 DELIVERY, STORAGE, AND HANDLING

- A. Deliver, store, and handle materials and products in strict compliance with manufacturer's instructions, recommendations, and industry standards.
- B. Store materials in manufacturer's original labeled packaging until ready for installation and in accordance with manufacturer's instructions. Protect from damage.

### PART 2 - PRODUCTS

#### 2.7 MANUFACTURERS

- A. Manufacturers: Subject to compliance with requirements, provide products by one of the following:
  - 1. 12 Lite Doors: TruStile Doors, LLC. (Basis of Design "TruStile Reserve Wood" FL1200)
  - 2. Single Lite doors: Duratherm Corporation
  - 3. Approved equal.

#### 2.8 DOOR CONSTRUCTION, GENERAL

- A. Stile and Rail Doors:
  - 1. Provide true stile and rail doors with components comprised of engineered composite core (LVL) with wood veneer faces and hardwood at exposed edges.
  - 2. Square Stick Sash door profile.
  - 3. Glazing: 1/4" Tempered.
- B. Fire-Protection-Rated Doors: Provide core specified or mineral core as needed to provide fire-protection rating indicated.
  - 1. Edge Construction: Provide edge construction with intumescent seals concealed by outer stile. Comply with specified requirements for exposed edges.
  - 2. Pairs: Provide fire-retardant stiles that are listed and labeled for applications indicated without formed-steel edges and astragals. Provide stiles with concealed intumescent seals. Comply with specified requirements for exposed edges.

#### 2.9 VENEERED-FACED DOORS

- A. Interior Stile and Rail doors:
  - 1. Grade: Premium, with Grade A faces.

2. Species: Cherry.
3. Cut: Plain Sliced.

## 2.10 LOUVERS AND LIGHT FRAMES

- A. Wood-Veneered Beads for Light Openings in Fire-Rated Doors: Manufacturer's standard wood-veneered noncombustible beads matching veneer species of door faces and approved for use in doors of fire-protection rating indicated. Include concealed metal glazing clips where required for opening size and fire-protection rating indicated.

## 2.11 FABRICATION

- A. Factory fit doors to suit frame-opening sizes indicated. Comply with clearance requirements of referenced quality standard for fitting unless otherwise indicated.
  1. Comply with requirements in NFPA 80 for fire-rated doors.
- B. Openings: Cut and trim openings through doors in factory.
  1. Light Openings: Trim openings with moldings of material and profile indicated.
  2. Glazing: Factory install glazing in doors indicated to be factory finished. Comply with applicable requirements in Division 08 Section "Glazing."
  3. Louvers: Factory install louvers in prepared openings.
  4. Hardware Preparation: Prefit and premachine doors at factory.

## 2.12 FACTORY FINISHING

- A. Transparent Finish:
  1. Grade: Custom.
  2. Finish: AWI catalyzed polyurethane system.
  3. Staining: As approved by architect to match existing doors.
  4. Effect: Filled finish.
  5. Sheen: Satin.

## PART 3 - EXECUTION

### 3.2 INSTALLATION

- A. Hardware: For installation, see Division 08 Section "Door Hardware."
- B. Installation Instructions: Install doors to comply with manufacturer's written instructions and the referenced quality standard, and as indicated.
  1. Install fire-rated doors in corresponding fire-rated frames according to NFPA 80.

C. Job-Fitted Doors: Align and fit doors in frames with uniform clearances and bevels; do not trim stiles and rails in excess of limits set by manufacturer or permitted for fire-rated doors. Machine doors for hardware. Seal edges of doors, edges of cutouts, and mortises after fitting and machining.

1. Clearances: Provide 1/8 inch at heads, jambs, and between pairs of doors. Provide 1/8 inch from bottom of door to top of decorative floor finish or covering unless otherwise indicated. Where threshold is shown or scheduled, provide 1/4 inch from bottom of door to top of threshold unless otherwise indicated.

a. Comply with NFPA 80 for fire-rated doors.

D. Factory-Fitted Doors: Align in frames for uniform clearance at each edge.

E. Factory-Finished Doors: Restore finish before installation if fitting or machining is required at Project site.

F. Protection: Advise General Contractor of proper procedures required to protect installed wood doors from damages or deterioration until acceptance of entire project.

END OF SECTION 081433

## SECTION 083113 - ACCESS DOORS AND FRAMES

### PART 1 - GENERAL

#### 1.1 SUMMARY

A. Section Includes:

1. Access doors and frames for walls and ceilings.

#### 1.2 ACTION SUBMITTALS

A. Product Data: For each type of product.

B. Shop Drawings: Include plans, elevations, sections, details, and attachments to other work.

C. Samples: For each door face material.

### PART 2 - PRODUCTS

#### 2.1 PERFORMANCE REQUIREMENTS

A. Fire-Rated Access Doors and Frames: Units complying with NFPA 80 tested according to the following test method:

1. NFPA 252 or UL 10B for fire-rated access door assemblies installed vertically.
2. NFPA 288 for fire-rated access door assemblies installed horizontally.

#### 2.2 ACCESS DOORS AND FRAMES FOR WALLS AND CEILINGS

A. Manufacturers: Subject to compliance with requirements, provide products by the following:

1. Babcock-Davis.
2. J. L. Industries, Inc.; Div. of Activar Construction Products Group.
3. Karp Associates, Inc.
4. Larsen's Manufacturing Company.
5. Milcor Inc.
6. Nystrom, Inc.

B. Source Limitations: Obtain each type of access door and frame from single source from single manufacturer.

C. Fire-Rated, Flush Access Doors with Concealed Flanges:

1. Assembly Description: Fabricate door to fit flush to frame, with a core of mineral-fiber insulation enclosed in sheet metal. Provide self-latching door with automatic closer and interior latch release. Provide frame with gypsum board beads for concealed flange installation.
2. Locations: Wall and ceiling.
3. Fire-Resistance Rating: Not less than that of adjacent construction.
4. Temperature-Rise Rating: 450 deg F at the end of 30 minutes.
5. Uncoated Steel Sheet for Door: Nominal 0.036 inch, 20 gage.
  - a. Finish: Factory finish.
6. Frame Material: Same material, thickness, and finish as door.
7. Hinges: Manufacturer's standard.
8. Hardware: Latch.

D. Hardware:

1. Latch: Cam latch operated by screwdriver.

## 2.3 MATERIALS

- A. Steel Plates, Shapes, and Bars: ASTM A 36/A 36M.
- B. Steel Sheet: Uncoated or electrolytic zinc coated, ASTM A 879/A 879M, with cold-rolled steel sheet substrate complying with ASTM A 1008/A 1008M, Commercial Steel (CS), exposed.
- C. Frame Anchors: Same type as door face.
- D. Inserts, Bolts, and Anchor Fasteners: Hot-dip galvanized steel according to ASTM A 153/A 153M or ASTM F 2329.

## 2.4 FABRICATION

- A. General: Provide access door and frame assemblies manufactured as integral units ready for installation.
- B. Metal Surfaces: For metal surfaces exposed to view in the completed Work, provide materials with smooth, flat surfaces without blemishes. Do not use materials with exposed pitting, seam marks, roller marks, rolled trade names, or roughness.
- C. Doors and Frames: Grind exposed welds smooth and flush with adjacent surfaces. Furnish attachment devices and fasteners of type required to secure access doors to types of supports indicated.
- D. Latching Mechanisms: Furnish number required to hold doors in flush, smooth plane when closed.



## 2.5 FINISHES

- A. Comply with NAAMM's "Metal Finishes Manual for Architectural and Metal Products" for recommendations for applying and designating finishes.
- B. Protect mechanical finishes on exposed surfaces from damage by applying a strippable, temporary protective covering before shipping.
- C. Appearance of Finished Work: Noticeable variations in same piece are not acceptable. Variations in appearance of adjoining components are acceptable if they are within the range of approved Samples and are assembled or installed to minimize contrast.
- D. Steel and Metallic-Coated-Steel Finishes:
  - 1. Factory Finish: Immediately after cleaning and pretreating, apply manufacturer's standard two-coat, baked-on finish consisting of prime coat and thermosetting topcoat, with a minimum dry-film thickness of 1 mil for topcoat.

## PART 3 - EXECUTION

### 3.1 INSTALLATION

- A. Comply with manufacturer's written instructions for installing access doors and frames.
- B. Install doors flush with adjacent finish surfaces or recessed to receive finish material.

### 3.2 ADJUSTING

- A. Adjust doors and hardware, after installation, for proper operation.
- B. Remove and replace doors and frames that are warped, bowed, or otherwise damaged.

END OF SECTION 083113

## SECTION 083480 – AUTOMATIC OVERHEAD COILING FABRIC SMOKE CURTAINS

### PART 1 - GENERAL

#### 1.1 SUMMARY

A. Section Includes:

1. Fire alarm or smoke detector-activated, overhead coiling fabric smoke curtain.
2. Self-closing without auxiliary power.

#### 1.2 SUBMITTALS

A. Comply with Section 013300–Submittal Procedures:

1. Product data.
2. Shop drawings:
  - a) Include opening dimensions.
  - b) Show and identify related work performed under other sections of the specifications.
3. Quality Assurance/Control Submittals:
  - a) Certifications.
  - b) Manufacturer’s installation instructions and testing procedures.

#### 1.3 CLOSEOUT SUBMITTALS

A. Comply with Section 017700–Project Closeout Procedures:

1. Operation and maintenance manual.
2. Manufacturer’s warranty.

#### 1.4 QUALITY ASSURANCE

A. Certifications:

1. ETL Listing to UL standards:
  - a) 864 - Control units for fire protective signaling systems.
  - b) 268 - Smoke detectors for fire protective signaling systems.
  - c) 1784 – Air leakage

B. Pre-Installation Meeting:

1. Schedule and convene a pre-installation meeting prior to commencement of field operations with representatives of the following in attendance: Owner, Architect, General Contractor, smoke curtain sub-contractor, and electrical sub-contractor.
2. Review substrate conditions, requirements of related work, installation instructions, storage and handling procedures, and protection measures.
3. Document the responsibilities of various parties and deviations from specifications and installation instructions.

#### 1.5 DELIVERY, STORAGE, AND HANDLING

- A. Comply with manufacturer's instructions.

#### 1.6 WARRANTY

- A. Provide manufacturer's standard one-year warranty.

#### 1.7 MAINTENANCE AND TESTING:

- A. Perform minimum semi-annual maintenance and testing on each smoke curtain as required by the manufacturer's warranty, code agency evaluation reports, and as required by local authority having jurisdiction.
- B. Provide test documentation.

### PART 2 - PRODUCTS

#### 2.1 MANUFACTURED UNITS

- A. Model M2500.
- B. Manufacturer:
  - 1. Smoke Guard, Inc.
  - 2. Distributed by Smoke Guard, 287 N. Maple Grove, Boise, Idaho 83704  
[www.smokeguard.com/](http://www.smokeguard.com/)
- C. Label each smoke curtain with following information:
  - 1. Manufacturer's name.
  - 2. Label of quality control agency.

#### 2.2 PERFORMANCE / DESIGN CRITERIA

- A. Test normal and fire operation: Curtain to deploy on activation of building fire alarm system signal or test key switch. Curtain shall descend and rewind by motor drive.
  - 1. Raise curtain after test and after fire alarm is cleared.  
Reset curtain after test or operation of unit using key switch. No manual reset required.  
No service call needed. No replacement parts needed.
- B. Test to 6,000 cycles.

#### 2.3 COMPONENTS

- A. Curtain Fabric: SG Tex 10 - Glass fiber material that is coated on both sides with a polyurethane.
  - 1. Rating: UL Standard 1784 – Air Leakage
- B. Side Guide Assembly:

1. Side Guide recessed in wall.
- C. Housing/Bearing Type: Standard or support bearing.
- D. Bottom Bar: Weighted for self-closing by gravity with sensing edge.
- E. Rewind Motor:
  1. Tubular motor with fail safe gravity deploy operation.
  2. 24 VDC.
- F. Control System:
  1. Comply with UL Standard 864.
  2. Battery backup supplied with the controls.
  3. 120 VAC power
- G. Finishes:
  1. Manufacturer's standard galvanized finish.

## 2.4 FABRICATION

- A. Installation Configuration: Housing attached directly to substrate above opening.
- B. Fabricate and install mounting brackets, hardware, and fasteners needed to attach smoke curtain assembly to building structure.

## PART 3 - EXECUTION

### 3.1 EXAMINATION

- A. Examine substrates upon which work will be installed.
  1. Verify related work performed under other sections is complete and in accordance with shop drawings.
  2. Verify wall surfaces are acceptable for installation of smoke curtain system components.
- B. Coordinate with responsible entity to perform corrective work on unsatisfactory substrates.
- C. Coordinate electrical interface and connection with Division 26.
- D. Coordinate interface and connection with fire and alarm system.
- E. Commencement of work by installer is acceptance of substrate.

### 3.2 INSTALLATION

- A. Install smoke curtain system components in accordance with manufacturer's installation instructions.

3.3 FIELD QUALITY CONTROL

- A. Field Test: Follow manufacturer's cycle test procedures.
  - 1. Notify Owner's Representative, local Fire Marshal and alarm sub-contractor minimum one week in advance of scheduled testing.
  - 2. Complete maintenance service record.

3.4 DEMONSTRATION

- A. Demonstrate required testing and maintenance procedures to Owner's Representative.

END OF SECTION 083480

Issued for Construction

Verrill Dana Interior Renovations  
Portland, Maine  
Project No. 16001

September 21, 2016

083113 - 6 AUTOMATIC OVERHEAD COILING SMOKE CURTAINS

## SECTION 084311 – FOLDING WOOD-FRAMED GLASS DOORS

### PART 1 - GENERAL

#### 1.1 SUMMARY

A. Section Includes:

- Interior top-hung folding wood-framed glass panel system.

#### 1.2 PREINSTALLATION MEETINGS

- A. Preinstallation Conference: Conduct conference at Project site.

#### 1.3 ACTION SUBMITTALS

- A. Product Data: Submit manufacturer's printed product literature for each Folding Glass Storefront system to be incorporated into the Work. Show performance test results and details of construction relative to materials, dimensions of individual components, profiles, and colors.
- B. Shop Drawings: Indicate Folding Glass Storefront system component sizes, dimensions and framing R.O., configuration, swing panels, direction of swing, stacking layout, typical head jamb, side jamb, and sill details, type of glazing material, handle height, and field measurements.
- C. Manufacturer's Instructions: Submit manufacturer's installation instructions.
- D. Samples: of each exposed finish required.

#### 1.5 CLOSEOUT SUBMITTALS

- A. Operation and Maintenance Data: Submit Owner's Manual from manufacturer. Identify with project name, location, and completion date, and type and size of unit installed.

#### 1.6 QUALITY ASSURANCE

- A. Installer Qualifications: An entity that employs installers and supervisors who are trained and approved by manufacturer and are experienced in the installation of manufacturer's products or other similar products for large openings.
- B. Product Options: Information on Drawings and in Specifications establishes requirements for aesthetic effects and performance characteristics of assemblies. Aesthetic effects are indicated by dimensions, arrangements, alignment, and profiles of components and assemblies as they relate to sightlines, to one another, and to adjoining construction.

1. Do not change intended aesthetic effects, as judged solely by Architect, except with Architect's approval. If changes are proposed, submit comprehensive explanatory data to Architect for review.

#### 1.7 DELIVERY, STORAGE, AND HANDLING

A. Comply with the Manufacturer's instructions and recommendations:

1. Deliver materials to job site in sealed, unopened cartons or crates. Upon receipt, inspect the shipment to ensure it is complete, in good condition, and meets project requirements.
2. Condition wood components to average prevailing relative humidity before installation. Do not subject wood components to extreme nor rapid changes in heat or humidity.
3. Do not use forced heat to dry out building.
4. Store flat in a well ventilated area out of direct sunlight under cover in a clean and dry location, protecting units against weather and defacement or damage from construction activities, especially to the edges of panels.

#### 1.8 FIELD CONDITIONS

A. Field Measurements: Contractor to field verify dimensions of rough openings and threshold depressions to receive sill. Mark field measurements of shop drawing submittal.

#### 1.9 WARRANTY

A. Manufacturer's Warranty: Provide Folding Glass Storefront manufacturer's standard limited warranty as per manufacturer'.

1. Warranty Period: 10 years from date of Substantial Completion.

B. Special Finish Warranty: Standard form in which manufacturer agrees to repair finishes or replace aluminum that shows evidence of deterioration of factory-applied finishes within specified warranty period.

1. Warranty Period: 20 years from date of Substantial Completion.

### PART 2 - PRODUCTS

#### 2.1 PERFORMANCE REQUIREMENTS

A. Basis of Design: Nana Wall model WD65



## 2.2 PERFORMANCE REQUIREMENTS

### A. Design Criteria:

1. Sizes and Configurations as indicated by the drawings for selected number and size of panels, locations of swing panels, and location of tracks and stacking bays.
2. Unit designation:
  - a. 995C.
  - b. 10-01D
3. Unit Operation:
  - a. Inswing type.
  - b. Inswing type.
4. Panel configuration:
  - a. Straight.
  - b. Straight
5. Stack storage configuration:
  - a. Inside jamb.
  - b. Inside jamb - unhinged doors stack in wall recess
6. Mounting type:
  - a. Top hung.
  - b. Top hung.
7. Sill type:
  - a. Flush sill recessed in existing floor.
  - b. Flush sill recessed in existing floor.
8. Panel size:
  - a. As indicated on drawings.
  - b. As indicated on drawings.
9. Panel pairing configuration:
  - a. i3L2R Center swing door.
  - b. 2LR+2LR No swing door, unhinged pairs.
10. Glazing:
  - a. ¼" thick single laminated.
  - b. ¼" thick single laminated.
11. Panel configuration:
  - a. Two light.
  - b. single light.
12. Wood species:
  - a. Cherry.
  - b. Cherry.
13. Wood finish:
  - a. Factory water-based, open pore clear sanding sealer for stain with one additional clear coat. See section 099000 for field finish.
  - b. Factory water-based, open pore clear sanding sealer for stain with one additional clear coat. See section 099000 for field finish.
14. Hardware:
  - a. Standard lever handle.
  - b. Flat handle, supplemental bolt.
15. Hardware finish:
  - a. Black titanium.
  - b. Black titanium.

## PART 3 - EXECUTION

### 3.1 EXAMINATION

#### A. Examination and Acceptance of Conditions:

1. Carefully examine rough openings with Installer present for compliance with requirements affecting Work performance.
  - a. Examine surfaces of openings and verify dimensions; verify rough openings are level, plumb, and square, with no unevenness, bowing, or bumps on the floor; and other conditions as required by the manufacturer for readiness to receive Work.
  - b. Verify structural integrity of the header for deflection with live and dead loads limited to the lesser of  $L/720$  of the span or  $1/4$  inch. Provide structural support for lateral loads when the panels are stacked open.
2. Proceed with installation only after unsatisfactory conditions have been corrected.

### 3.2 INSTALLATION

- #### A. General: Install Folding Glass Storefront system in accordance with the Drawings, approved submittals, manufacturer's recommendations and installations instructions.

### 3.3 FIELD QUALITY CONTROL

- #### A. Verify the Folding Glass Storefront system operates and functions properly. Adjust hardware for proper operation.
- #### B. Non-Conforming Work: Repair or replace non-conforming work as directed by the Architect.

### 3.4 CLEANING AND PROTECTION

- #### A. Keep units closed and protect Folding Glass Storefront installation against damage from construction activities.
- #### B. Remove protective coatings and use manufacturer recommended methods to clean exposed surfaces.

END OF SECTION 084113

## SECTION 085200 – WOOD WINDOWS

### PART 1 - GENERAL

#### 1.4 SUMMARY

A. Section Includes:

1. Interior storefront with factory glazed components and reinforcing as required.
2. Doors: Operable wood stile and rail doors as integral part of storefront system.
  - a. Refer to section 081433 Stile and Rail Wood Doors for additional requirements.

#### 1.5 PREINSTALLATION MEETINGS

- A. Preinstallation Conference: Conduct conference at Project site.

#### 1.6 ACTION SUBMITTALS

- A. Product Data: For each type of product.

- B. Shop Drawings: Include plans, elevations, sections, full-size details, and attachments to other work.

1. Schedule: Window types, sizes, locations, and quantities, keyed to scale elevations. Identify materials, finish and species of woods, glazing types, hardware, and anchoring provisions.
2. Details: Full or large scale, keyed to scale elevations. Show frame and sash construction, glazing, weep/vent provisions, hardware, weather-stripping and anchorage.
3. Installations: Clearly show relation to adjoining construction. Give blocking requirements, clearances, weather proofing & flashing recommendations and all other instructions necessary for proper installation.

- C. Samples: Duplicate pairs of samples for each species of unfinished and transparent finished wood proposed for production work.

1. Samples shall be large enough to accurately show typical appearance characteristics.
2. Each pair of samples shall show extremes of appearance characteristic of range proposed for the work. Wood used for production shall be within this range

#### 1.10 CLOSEOUT SUBMITTALS

- A. Maintenance data. Two copies of window manufacturer's product manual with recommendations for routine owner maintenance of window units, hardware and wood finishes; and instructions for removing and replacing sash and glass.

### 1.11 QUALITY ASSURANCE

- A. Single Source Responsibility:
  - 1. Provide window and door systems that are products of a single manufacturer.
- B. Certifications:
  - 1. Fabricator Qualifications: Not less than 10 years prior successful production of units similar to those required. List projects having windows of the kind required for the project. Installations shall have been done to meet job conditions and performance requirements of the kind shown and specified for this project. Give installation dates, locations, contact names, addresses, and phone numbers for each project
  - 2. Test Report: Certified independent testing agency reports to show compliance with specified window performance requirements. Tests shall have been made within 5 years of submission. Reports shall include test descriptions and results, as well as sufficient product descriptions to show that tested products are representative of those proposed for the project.
  - 3. Installer Qualifications: Certified in writing by manufacturer with documented experience on at least 5 projects of similar nature in past 5 years.

### 1.12 DELIVERY, STORAGE AND HANDLING

- A. Deliver factory-assembled, preglazed windows in enclosed vans. Bundle and label loose materials as necessary to prevent loss and damage.
- B. Store products in a clean, protected, dry, well-ventilated building, on platforms or blocking at least 4 inches above floor. Stack products so they do not warp, bend or twist. Store windows upright, not flat or leaning, with at least ¼" air space between units. General contractor is responsible for storage on site.
- C. Protect glazing and frame components from adverse job conditions before, during, and after installation including but not limited to:
  - 1. Condensation, temperature changes, direct exposure to sun or other causes that could otherwise damage the assemblies.
  - 2. The work of other trades before, during, and after installation (e.g., weld slag, run down staining, masonry dust and similar).
  - 3. Adhere to glass manufacturer's recommendations for venting and sealing insulated units to avoid hermetic seal ruptures or glass breakage at high altitude locations.
  - 4. Handle windows with clean hands or canvas gloves.

### 1.13 PROJECT CONDITIONS

- A. Connecting Work: Constructed to specified tolerances. Field dimensions agreed upon prior to fabrication.
  - 1. Environmental Conditions: Air temperature during installations shall be at least 40° F and rising, and the wind light or still. Work areas and materials shall be dry and free of ice and snow. Ensure ambient and surface temperatures and joint conditions are suitable for installation of materials.

## 1.14 WARRANTY

- A. Provide written warranty signed by manufacturer stating that work is free from defective materials, defective workmanship, glass breakage due to defective design, and agreeing to replace components which fail under normal operation.
  - 1. Material and workmanship warranty term: 3 years from date of Substantial Completion.
- B. Provide written warranty agreeing to replace defective insulating glass units and stating that insulating glass units will be free from condensation, fogging and obstruction of vision due to film on internal surfaces for 10 years from date of installation. Replacement includes labor and materials.
  - 1. Warranty Glass seal failure warranty term: 10 years from date of Substantial Completion.

## PART 2 - PRODUCTS

### 2.1 PERFORMANCE REQUIREMENTS

- A. Performance Requirements:
  - 1. Air Infiltration: Air leakage shall not exceed 0.15 CFM per square foot of surface area for fixed units and 0.30 CFM per foot of sash crack when tested in accordance with ASTM E283 at differential static pressure of 6.24 psf.
  - 2. Water Infiltration: No uncontrolled leakage when tested in accordance with ASTM E547 at test pressure of 6.24 psf, or 20 percent of full positive design wind load, whichever is greater.
  - 3. Thermal Transmittance: Provide window units with the following U-value as determined according to NFRC 100 or calculated according to LBNL Window 5.2 computer analysis.
    - a. U-value typical of 1/4" tempered glass for interior use.
  - 4. Forced-Entry Resistance: Comply with Performance Level 10 requirements when tested according to ASTM F588.
- B. Structural Loads: When tested in accordance with ASTM E330 at 150 percent of design pressure, no failure or permanent deflection in excess of 0.003 of any member's span after removing the imposed load, for a positive (inward) and negative (outward) design pressure of 60 psf.

### 2.2 MANUFACTURERS

- A. Basis of Design: Duratherm Corporation, 720 Main Street, Vassalboro, ME 04989  
Telephone: (800) 996-5558 / Email: [info@durathermwindow.com](mailto:info@durathermwindow.com).
- B. Other Acceptable Manufacturers: Subject to compliance with requirements listed herein, provide either the named product or a comparable product that meets visual, physical and performance criteria as judged solely by the Architect.

### 2.3 FRAME MATERIALS

- A. Lumber: All pieces shall be dried to an average moisture content of 12% (9-14% for individual pieces) before assembly and treatment.
- B. Wood Species: All interior sash and frame components.
  - 1. American Cherry (*Prunus serotina*).

## 2.4 HARDWARE

- A. Anchor Bolts and Screws: Hex head through-bolts and flat head wood screws shall be of corrosion resistant type (zinc chromate, galvanized or stainless steel).
- B. Waterproof Adhesive: Resorcinol, melamine, or polyvinyl acetate emulsion type.
- C. Anchor Clips: Teco, Simpson Strong-Tie Connectors®, or equal.

## 2.5 GLAZING

- A. Glazing: Comply with Section 088000 "Glazing."
- B. Glazing Gaskets: Manufacturer's standard sealed-corner pressure-glazing system of black, resilient elastomeric glazing gaskets, setting blocks, and shims or spacers.
- C. Glazing Sealants: As recommended by manufacturer.
- D. Interior removable glazing stops to be screwed in-place for ease of removal and maintenance.
- E. Glazing channel shall be weeped/pressure relief vented per window manufacturer's requirements.

## 2.6 FABRICATION

- A. Windows: Produced from standard components. Wood components shall be solid lumber. Like parts shall be interchangeable. Fitting, machining for hardware and glazing shall be done in the factory.
- B. Frames: AWI Custom Grade Exterior Frames.
- C. Sash: AWI Custom Grade Finished Exterior Sash. Fixed and operable sash incorporate removable interior glass stops for ease of reglazing.
- D. Permanent Joints and Facings: Bonded with water-resistant adhesive.
- E. Wood Finish, Interior:
  - 1. Stain as approved by Architect to match existing.

2. One (1) coat Sher-Wood® vinyl sealer T67F3 and two (2) coats Sher-Wood® Hi-Bild Catalyzed Lacquer T77F58.

F. Measurements:

1. Take accurate field measurements to verify required dimensions prior to fabrication.
2. Where field dimensions can not be made without delaying the work, establish opening dimensions and proceed with fabricating windows without field dimensions. Coordinate wall construction to ensure that the actual opening dimensions correspond to established dimensions.

G. Fabricate components in accordance with manufacturer's tested assemblies. Shop fabricate, glaze, and finish to greatest extent practical to minimize field assembly. Disassemble only to extent necessary for shipping and handling limitations.

H. Fabricate components true to detail and free from defects impairing appearance, strength or durability.

### PART 3 - EXECUTION

#### 3.1 EXAMINATION

- A. Examine conditions with installer present for compliance with all requirements. Inspect wall flashings, vapor retarders, water and weather barriers, and other built in components to ensure a weather tight installation.
- B. Verify dimensions, tolerances, and method of attachment with other work.
- C. Proceed with installation only after unsatisfactory conditions have been corrected.

#### 3.2 INSTALLATION

- A. General: Install windows per approved shop drawings, in proper relation to adjoining construction. Do not twist frames or force fit them into poorly prepared openings. Anchor windows as required to satisfy design requirements. See manufacturer's installation instructions and shop drawings.
- B. Center window units in wall openings leaving a uniform interface caulking recess on all four sides. The manufacturer strongly suggests that sealant be selected for its adhesion compatibility with the specified exterior wood and adjacent wall materials. Consult the manufacturer for recommended sealant.
- C. Level units: Install shims at bearing locations, anchors, and latchpoint, so they are not dislodged by subsequent operations. Test sash operation and sash alignment before permanently anchoring units.
- D. Anchorage: Install anchors through frame centerline beside shims. Anchor window units to wood blocking with wood screws and to metal framing with Tek screws; countersink anchor

heads. All anchors shall be concealed by closed sash or with wood plugs.

- E. Installation to conform to window manufacturer's requirements as indicated in the manufacturer's product manual.

### 3.3 CLEANING

- A. Clean surfaces in compliance with manufacturer's recommendations; remove excess mastic, mastic smears, foreign materials and other unsightly marks.
- B. Clean exposed surfaces exercising care to avoid damage.
  - 1. Remove adhered matter and excess sealant materials.
  - 2. Replace glass which is broken, cracked, chipped, scratched, abraded or damaged in other ways.
- C. Wash glass on interior and exterior to remove paint, soil, prints and foreign matter. It is strongly advised that procedures and methods outlined in the following documents be strictly adhered to when cleaning Architectural glass.
  - 1. Glass Association of North America (GANA) Technical Bulletin 01-0300: *Glass Cleaning Procedure*.
  - 2. GANA Technical Bulletin TD-02-0402: *Heat-treated Glass Surfaces Are Different*.
  - 3. PPG Glass Technical Document TD-142: *Glass Cleaning Recommendations*.

### 3.4 PROTECTION

- A. Institute protective measures required throughout the construction period to ensure that windows will be without damage or deterioration.

END OF SECTION 085200



## SECTION 087100 – FINISH HARDWARE, ACCESS CONTROL, LOW VOLTAGE WIRING

### PART 1 –GENERAL

#### 1.01 RELATED DOCUMENTS

- A. All of the Contract Documents, including General and Supplementary Conditions and Division 1 General Requirements, apply to the work of this section.

#### 1.02 DESCRIPTION OF WORK

- A. The work of this section includes, but is not limited to, the following:
  - 1. Providing hardware for all doors, except doors provided with their own hardware.
  - 2. Providing lock cylinders for all work requiring cylinders.
  - 3. Providing the services of a qualified hardware consultant to prepare detailed schedules of hardware required for the project.
  - 4. Provide all low voltage wire and wiring for access control system. Locate card access controller in IT/Computer Room 885.
  - 5. Card Access System to be a continuation of existing Sielox card access system.

#### 1.03 RELATED WORK

- A. Carefully examine all of the Contract Documents for requirements which affect the work of this section. Other specifications sections which directly relate to the work of this section include, but are not limited to, the following:
  - 1. Section 08100 – Hollow Metal Doors and Frames; work requiring template coordination, metal astragals for fire-rated doors.
  - 2. Section 08210 – Wood Doors; work requiring template coordination, metal astragals for fire-rated doors.
  - 3. Division 26 – Electrical conduit and raceways.

#### 1.04 INTENT

- A. A major intent of the work of this section is to provide hardware for every door in the project, except as indicated, so that each door functions correctly for its intended use. Provide only hardware that complies with applicable codes and requirements of authorities having jurisdiction including requirements for barrier-free accessibility.

#### 1.05 QUALITY ASSURANCE

- A. Hardware supplier shall have in his employ one or more members of the Door and Hardware Institute to include at least one Certified Architectural Hardware Consultant in good standing, who shall be responsible for preparation of the Finish Hardware Schedule. This Consultant shall be acceptable to the Architect and is to ensure that the intent requirement of this specification is fulfilled, and certify that the work of this section meets or exceeds the requirements specified in this section and the requirements of authorities having jurisdiction.

- B. Hardware supplier shall warrant and guarantee, in writing, that hardware supplied is free of defective material and workmanship. Supplier shall further warrant and guarantee for a period of one year from Owner's Use and Occupancy that the hardware shall function in a satisfactory manner without binding, collapse, or dislodging of its parts, provide the installation is made to the manufacturer's recommendations.
- C. The hardware supplier shall repair or remedy, without charge, any defect of workmanship or material for which he is responsible hereunder.

#### 1.06 SUBMITTALS

##### A. Submit the following in accordance with SECTION 01300-SUBMITTALS:

- 1. **Schedule:** Submit to the Architect electronic (pdf) copy of the complete hardware schedule within the fourteen (14) days after receipt of contract award. Submit therewith complete catalog cuts and descriptive data of all products specifically scheduled therein. No materials shall be ordered or templates issued until the hardware schedule has been approved by the Architect. Form and detail of hardware schedule shall be in vertical format in conformance to the door and hardware industry standards. All hardware sets shall be clearly cross-referenced to the hardware set numbers listed in the specifications.
- 2. **Samples:** If requested, submit to the Architect for approval, a complete line of samples as directed. Samples shall be plainly marked giving hardware number used in this specification, the manufacturer's numbers, types and sizes. The Architect will deliver approved samples to the project site to be stored. Samples will remain with the Architect until delivery of all hardware to the project is complete, after which time they will be turned over to the General Contractor for incorporation into the work.
- 3. **Keying System Submission:** Before cylinders are ordered, submit a complete proposed keying system for approval. This should be done after a keying meeting has been held with the owner's representative.

#### 1.07 PRODUCT DELIVERY, STORAGE AND HANDLING

- A. Delivery of hardware shall be made to the project by the Hardware Supplier in accordance with the instructions of the General Contractor.
- B. The finish hardware shall be delivered to the jobsite and received there by the General Contractor. The General Contractor shall prepare a locked storage room with adequate shelving, for all hardware. The storage room shall be in a dry, secure area, and shall not include storage of other products by other trades.
- C. The General Contractor shall furnish the Hardware Supplier with receipts for all hardware and accessory items received, and shall send copies of these receipts to the Architect, if requested.

#### 1.08 REGULATORY REQUIREMENTS

- A. Conform to all applicable codes. Provide all throws, projections, coatings, knurling, opening and closing forces, and other special functions required by State and Local

Building Codes, and all applicable Handicap Code requirements.

- B. For fire rated openings, provide hardware complying with NFPA 80 and NFPA 101 without exception. Provide only hardware tested by UL for the type and size of door installed and fire resistance rating required.

1.09 SPECIAL REQUIREMENTS

- A. Hardware Supplier shall determine conditions and materials of all doors and frames for proper application of hardware.
- B. The Hardware Schedule shall list the actual product series numbers. Bidders are required to follow the manufacturers’ catalog requirement for the actual size of door closers, brackets and holders. All door opening sizes are as noted on the Door Schedule and all hardware shall be in strict accordance with requirements of height, width, and thickness.

PART 2 – PRODUCTS

2.01 ACCEPTABLE MANUFACTURERS

Hinges	McKinney Stanley	Scranton, PA New Britain, CT
Locksets	Sargent (No Exception)	New Haven, CT
Exit Devices	Sargent	New Haven, CT
Door Closers	Sargent	New Haven, CT
Door Stop	Glynn Johnson Ives Rockwood	Indianapolis, IN New Haven, CT Rockwood, PA
Card Access System	Sielox (No Exception)	Runnemede, NJ
Push/Pulls	Rockwood Burns Ives	Rockwood, PA Erie, PA New Haven, CT
Protective Plates	Rockwood Burns Ives	Rockwood, PA Erie, PA New Haven, CT
Thresholds/ Weatherstripping/ Rain Drips	NGP Pemko Reese	Memphis, TN Memphis, TN Rosemount, MN

Silencers	Ives	New Haven, CT
-----------	------	---------------

Glynn Johnson  
Rockwood

Indianapolis, IN  
Rockwood, PA

## 2.02 MATERIALS AND QUALITY

- A. All hardware shall be of the best grade of solid metal entirely free from imperfections manufacturer and finish.
- B. Qualities, weights, and sizes given herein are the minimum that will be accepted. It is the responsibility of the Hardware Supplier to supply the specified size and weight of hardware and the proper function of hardware in each case and to provide UL approved hardware at all fire rated doors.
- C. Provide, as far as possible, locks of one lock manufacturer and hinges of one hinge manufacturer. Modifications to hardware that are necessary to conform to construction shown or specified shall be provided as required for the specified operation and functional features.

## 2.03 HARDWARE DESIGNATIONS

- A. All items of hardware are referenced by manufacturer's names and numbers. The manufacturer's names and numbers are used to define the function, design, and the quality of the material to be supplied.

Substitution of products other than those listed shall be submitted to the Architect at least ten (10) days PRIOR to the bid date. The Architect shall be the sole judge of any proposed substitution.

## 2.04 TEMPLATES

- A. Hardware supplier shall immediately, but not later than three (3) days after approval of his Schedule by the Architect, furnish the General Contractor with complete template information necessary for the fabrication of doors, frames, etc. No templates shall be furnished prior to the approval of the hardware schedule.

## 2.05 HARDWARE FOR LABELED FIRE DOORS, EXIT DEVICES AND SMOKE DOORS

- A. Hardware shall conform to requirements of NFPA 80 for labeled fire doors and to NFPA 101 for exit doors, as well as to other requirements specified. Labeling and listing by UL Building Materials Directory, for class of door being used will be accepted as evidence of conformance to these requirements. Install minimum latch throw as specified on label of individual doors. Provide hardware listed by UL except where heavier materials, larger sizes, or better grades are specified herein under paragraph entitled "Hardware Sets". In lieu of UL labeling and listing, test reports from a nationally recognized testing agency may be submitted showing that hardware has been tested in accordance with UL test methods and that it conforms to NFPA requirements. Specific hardware requirements of door or frame manufacturers which exceed sized or weights of hardware herein listed shall be provided with no additional charge.

## 2.06 KEYS AND KEYING

- A. The hardware supplier shall review the specific hardware functions with the Architect and owner at the time of the keying review, to assure the appropriateness of each of the hardware functions. Failure to make this review does not relieve the hardware supplier from providing the proper functions.
- B. Key System: All cylinders shall be Masterkeyed and/or Grandmaster Keys to existing Sargent system established April 1987.
  - 1. Master keys, Grandmaster Keys: Furnish six (6) keys for each set, if required.
  - 2. Furnish three (3) change keys for each cylinder keyed differently; six (6) change keys for each set keyed alike, and in sets where only (2) cylinders are keyed alike, four (4) change keys will be required.
  - 3. All keying is to be done at the factory to avoid duplication of the new cylinders.
  - 4. Master Keys shall be sent to the Owner by registered mail, return receipt required.
  - 5. Supply a bitting list for all change keys and master keys to the Owner.
  - 6. All lock cylinders shall be set to Construction key for use by the Contractor during the construction period. Furnish ten (10) Construction keys and two (2) voiding the Construction key feature.

## 2.07 FASTENERS

- A. Manufacture hardware to conform to published templates, generally prepared for machine screw installation.
- B. Furnish screws for installation, with each hardware item. Provide Phillips flat-head screws except as otherwise indicated. Furnish exposed screws to match the hardware finish, or, if exposed in surfaces of other work, to match the finish of such other work as closely as possible, except as otherwise indicated.
- C. Provide concealed fasteners for hardware units which are exposed when the door is closed, except to the extent no standard manufactured units of the type specified are available with concealed fasteners. Do not use thru-bolts unless specifically approved by the Architect.
- D. All hardware shall be installed only with fasteners supplied by manufacturers of specific products.

## 2.08 PACKING AND MARKING

- A. All hardware shall have the required screws, bolts and fastenings necessary for proper installation and shall be wrapped in the same package as the hardware item for which it is intended and shall match finish of hardware with which to be used.
- B. Each package shall be clearly labeled indicating the portion of the work for which it is intended.

## 2.09 ENVIRONMENTAL CONCERN FOR PACKING

- A. The hardware shipped to the jobsite is to be packaged in biodegradable packs such as paper or cardboard boxes and wrapping. If non-biodegradable packing such as plastic, plastic bags or large amounts of Styrofoam is utilized, then the Contractor will be responsible for the disposal of the non-biodegradable packing to a licensed or authorized collector for recycling of the non-degradable packing.

2.10 FINISH HARDWARE DESCRIPTION

- A. Hardware items shall conform to respective specifications and standards and to requirements specified herein.

B. MATERIALS AND FINISH MATERIALS AND FINISHES SHALL BE:

- 1. Interior Butts: US26
- 2. Door Closers: US26
- 3. Exit Devices: US26
- 4. Kick, Push Plates: US32
- 6. All other hardware shall be: US26 as scheduled.

C. HINGES

- 1. Number of hinges per door, two hinges for doors up to and including five feet in height and an additional hinge for each two and one half feet or fraction thereof.
- 2. Hinges shall be as follows:

Exterior	McKinney	TA2314	4 ½ x 4 ½ NRP
	Stanley	FBB191	4 ½ x 4 ½ NRP
Interior	McKinney	TA2714	4 ½ x 4 ½
	Stanley	FBB179	4 ½ x 4 ½
Elec	McKinney	TA2714-QC12	

- 3. Provide Electro Lynx harnesses and components for wood doors.
- 4. Provide 15’-0” harness QC-C1500P harness from hinge location up the jamb to above ceiling or up and around full lite wood doors.

D. DOOR CLOSERS:

- 1. Door closers shall have fully hydraulic, full rack and pinion action. Cylinder body shall be 1-1/2” in diameter, and double heat treated pinion shall be 11/16” in diameter.
- 2. Hydraulic fluid shall be of a type requiring no seasonal closer adjustment for temperatures ranging from 120 degrees F to -30 degrees F.
- 3. Spring power shall be continuously adjustable over the full range of closer sizes, and allow for reduced opening force for physically handicapped. Hydraulic

regulation shall be by tamper-proof, non-critical valves. Closers shall have separate adjustment for latch speed, general speed, and hydraulic back-check.

4. All closers shall have solid forged steel main arms (and forged forearms for parallel arm closers).
5. Closer arms (metal covers) shall have a polished chrome finish (US26).
6. Provide drop, mounting plates, where required.
7. Do not locate closers on the side of doors facing corridors, passageways or similar type areas. Where it is necessary, due to certain conditions and approval of the Architect, to have closers in corridors, provide such closers with parallel or track type arms.
8. All door closers shall be adjusted by the installer in accordance with the manufacturer's templates and written instructions. Closers with parallel arms shall have back-check features adjusted prior to installation.
9. Closers shall conform to all applicable code requirements relative to setting closing speeds for closers and maximum pressure for operating interior and exterior doors.
10. Door closers meeting this specification are as follows:

	LCN	Sargent
Exterior	4111S-CUSH	281 – CPS
	4111S-H-CUSH	281 – CPSH
Interior	4011	281- 0
	4111	281 – P10
	4040SE	2407 Series
	4000T	281 – OT x spec. TEMP.
	4310ME-SF	2980
	4040SE-DE	2477

E. EXIT DEVICES:

1. Shall be Sargent as follows:

Function	Sargent
A	16-8804
B	8810
C	8813ET
D	8815ET
E	12-8804
F	12-8813ET
G	12-8815ET
H	8710

I	8713ET
J	8715ET
K	16-PP/PR8710
L	PP/PR8713ET
M	PP/PR8715ET
N	CD8710 x 306
O	12-8713ET
P	12-8715ET
Q	12-PP/PR8710
R	12-PP/PR8713ET
S	12PP/PR8715ET
T	56-8710 x 306
U	55 56-12 8813 ETL
V	55 56 NB WD 8610 x 106
W	55 56 NB WD 8610

NOTE: Lever design shall match lock trim

F. MORTISE LEVER HANDLE LOCKSETS STUDIO COLLECTION (NO EXCEPTION):

1. Locksets for this project shall be mortise type with solid cast stainless steel lever handle sectional trim.
2. The lockset case shall be 12 gauge heavy duty wrought steel with zinc dichromate finish.
3. Locksets shall have a simple reversibility of the hand by utilizing a screwdriver without disassembly of the lock case.
4. Latchbolt shall be a stainless steel 3/4" one-piece, anti-friction and reversible.
5. Strikes shall be non-handed curved lip stainless steel ANSI Standard A115.1, 4 7/8" x 1 1/4".
6. Locks and cylinders shall be manufactured and supplied by the same manufacturers. All locksets and cylinders for this project shall be manufactured in the United States of America by a recognized and reputable lock manufacturer.
7. The following is a guide to the manufacturers and designs acceptable for this project. Sargent 8200 Series LNW.
8. Lock functions as indicated in the hardware schedule shall be as follows:

Function	Sargent
A(Storeroom)	04
B(Storeroom) Tactile Warning	04
C(Office)	05
D(Passage)	15
E(Vestibule)	16
F(Classroom)	37
G(Office)	25
H(Privacy)	65
I(Dummy)	93



J(Keypad)	KP8276
K(Elec Lock)	RX71
L(Apartment)	43
M (Elec Lock)	RX72

G. PUSH PLATES, DOOR PULLS, PUSH/PULL BARS:

1. Shall be as manufactured by Rockwood, Burns or Ives.
  - a. Push plates shall be 4" x 16" x .050 thickness unless otherwise listed in hardware sets.
 

Rockwood	70 Series
Burns	50 Series
Quality	40 Series
  - b. Door pulls shall be 1" x 10"
 

Type A

Rockwood	BF157
----------	-------

H. KICK PLATES, ARMOR PLATES, MOP PLATES:

1. Kick plates shall be 8 in. high. Armor plates shall be 34 in. high. Mop plates shall be 4 in. high. All plates shall be 2 in. less the width of door. Plates shall be .050 thickness, bevel 4 edges, screws shall be oval head counter-sunk.

I. STOPS

1. Shall be furnished at all doors. Wherever and opened door or any item of hardware thereon strikes a wall, at 90 degrees. Provide wall bumpers, unless otherwise indicated in hardware sets.
2. Where wall bumpers cannot be effectively used, a floor stop shall be furnished and installed.
3. Provide roller bumpers for each door where two doors interfere with each other in swinging.

Manufacturer	Wall Bumpers	Floor Stops	Roller Bumpers
Rockwood	409	440, 442	456
Ives	407 ½	436B, 438B	470 Series
Glynn Johnson	WB 50XT	FB13, FB14	RB-3

4. Where overhead stops are listed they shall be the surface mounted type as follows:

Manufacturer	Series
--------------	--------

Sargent 1540

J. THRESHOLDS, WEATHERSTRIP, SEAL:

1. Thresholds shall be as detailed and furnished on all doors where shown on drawings. Thresholds shall be aluminum unless otherwise indicated. Set thresholds for exterior and acoustical doors in full bed of sealant complying with requirements specified in Division 7 Section "Joint Sealants".
2. Weatherstripping shall be furnished on all exterior doors unless otherwise indicated.

Product	Pemko	NGP
Threshold	as detailed	
Brush Seal	45062AP	A626A
Auto. Door	430CR	420
Bottom		
Door Sweep	345AV	101AV
Set Astragals	351C x 351CP	140 x 140P
Astragal	357SP	139SP
Rain Drip	346C	16A

3. Smoke Seals

Jamb Seals	S88D	5050 CL
Astragal Seals	S77C	5070 CI

K. POWER SUPPLY:

Provide Securitron BPS0 power supply or Von Duprin PS873.

L. ACCESS CONTROL, INTERCOM AND CCTV SYSTEM SPECIFICATIONS:

This document includes a general description, functional requirements, characteristics, and criteria for the Access Control System (ACS).

This specification provides information necessary to produce a complete proposal for a sophisticated, easy-to-use software, intelligent field advanced processing controller, communication devices, card readers/keypads, access cards, I/O boards, power supplies, conduit, raceways, enclosures, mounting hardware, and all other equipment as indicated on the contract drawings if supplied and as specified herein. All material shall be the manufacturer's standard catalog products. Backboxes, sleeves, raceways, conduit and line voltage for this system shall be provided by the electrical contractor.

I. 1. ACCESS CONTROL SYSTEM (ACS) OVERVIEW

- A. The ACS shall consist of multiple functional components and be compatible with Sielox access control hardware and the Pinnacle software platform.

I. 2. MANUFACTURER SHALL BE:

Sielox LLC  
 170 East Ninth Avenue  
 Runnemede, NJ 08078  
 800-424-2126 Toll Free  
 856-939-9300 Phone  
 856-939-9309 FAX  
[www.sielox.com](http://www.sielox.com)

I. 3. ACS COMPATIBLE HARDWARE

A. Server and Client Configuration

1. The server CPU shall be a 100% IBM compatible PC approved, plus checked against the ACS's known hardware compatibility list, with the following **minimum configurations** dependent upon system capacities and System size:

Operating System	<p><b>Lite, Standard, Plus, and Clients:</b> Windows Server 2003, 2008, Standard Edition w/SP1, Windows Server 2012</p> <p>OR - Windows 10 Professional / Enterprise, Windows 8.0 / 8.1 Pro, Windows 7 Professional 32-bit and support for 64-bit and Vista Business</p> <p><b>Professional:</b> Windows Server 2003, 2008 Standard Edition w/SP1, Windows Server 2012, Windows 8.0 / 8.1 Pro, Windows 10 Professional / Enterprise</p>
Microsoft SQL Server 2003, 2008 w/SP4 Database Engine Guidelines	<p><b>Lite, Standard, and Plus:</b> SQL 2000/2008 included; greater than 128 readers or 10K cardholders OR 5K events per hour or 4 client workstations OR database partitioning requires Standard or Enterprise Editions of SQL which is not included.</p> <p><b>Professional:</b> Standard or Enterprise Editions required (not included); SQL Express is included only to start up systems, SQL 2005, 2008 or 2012 required</p>
Hard Disk Size	1 - 500 GB - Raid 1 Mirror for Lite, 2 - 500GB Raid SATA Hot Swappable Raid 1 SATA HD for Standard, Plus, and Professional, computers/server should be upgradeable to RAID 5 if needed
Processor	<p>Lite and All Clients: Pentium 4, Single Core 3.8 GHz or higher</p> <p>Standard or Plus; 4 Dual Core 3.8GHz or higher</p> <p>Professional: Pentium 4 Dual Core 3.8GHz or higher</p>
Memory	Lite, Standard, Plus, Professional Clients: 2GB

	Lite, Standard, Plus Server 4GB Professional Server: 8 GB
CDR-DVD	Read Write for Both CD and DVD
Monitor/Video	19" LCD or Larger to suit application and desk space
Network Card	10/100/1000 MB
Mouse	USB or wireless
Ports	4 USB and 2 serial
Keyboard	USB or wireless
Speakers	Built in or external as application and desk space allow

**B. Multi-Hardware Communication Servers (Option)**

2. The ACS shall support an advance distributed architecture allowing the use of multiple hardware communication servers for limitless controller scalability and improved communications efficiency.
3. The multi-hardware communication server architecture shall also allow linked inputs and outputs between different hardware servers.
4. The ACS shall provide support for drag-and drop and cut and paste of Main Controllers setting across hardware communication servers and within the same hardware server, allowing hardware communication servers and door/reader's to be easily added to an existing configuration.

**C. System Field Controller**

5. The ACS shall support their legacy controllers, any new hardware will be 100% backwards compatible to all legacy hardware.
6. The controllers shall be 100% distributed intelligence architecture. Each controller shall operate independently of one another. If the ACS Controller communication is lost, it will NOT revert to a degraded mode of operation. The ACS Controller will continue operation without losing any features for cardholders or alarm functions, and it will retain a minimum of 10,000 events which will be down loaded to the sever upon the restoration of network communications. The failure of any ACS controller will result in a Maximum of 1 or 2 Card Reader doors in the off-line condition. Any controller offline condition that affects more than 1 or 2 readers will be considered unacceptable. Controllers that control 4, 8 or 16 reader are not acceptable to the Owner.
7. The controllers shall provide intelligent interface to intrusion detection and duress alarm devices, card reader devices, door locking and gate control mechanisms, elevator systems, local alarm devices, Intercom systems, and other auxiliary systems that may be part of a building security systems.
8. The ACS [AC-1700] controllers shall incorporate a 32-bit CPU, using high speed processing for maximum reliability. The design shall allow for a mixture of Readers and I/O support on a single board to facilitate expansion capabilities.  
Basic Controller

- a) One or two Reader Controller [**AC-1700**] – Provides support for up to two card readers each with support for, door strike, door contact, and request-to-exit devices. All aspects of each input and output can be completely configured to meet owner’s needs. Any controller that supports 4, 8, or 16 readers one controller will be considered unacceptable.
  - b) Each Controller [**AC-1700**] shall have a minimum of 4 auxiliary inputs – each input could be independently configured to be Supervised 4 states or unsupervised 2 states. All aspects of shunting and other timing features shall also be independently configured.
  - c) Each Controller [**AC-1700**] shall have a Minimum of 4 auxiliary outputs – each output should be Superviseable and completely programmable. Relays are assignable to activate in the normally open or normally closed positions. The outputs will be assignable to trip on any system event, either alarm type event or on any Card holder type event. Each relay on the Controller [**AC-1700**] shall be removable and field replaceable.
  - d) Each [**AC-1700**] shall support the expansion of at least 56 auxiliary inputs and or outputs
  - e) On board Ethernet Connection, with Network speed direct to into controller CPU. A POE option should also be available. The POE option will power the Controller and up to two card readers attached to the [**AC-1700**] ACS controller
  - f) Each [**AC-1700**] shall support up to 32 Allegion – Schlage AD and NDE series Locks.  
The introduction of wireless locks shall not replace the use of the 2 hard wired reader ports enabling the controller to communicate with up to 34 doors.
9. Controllers shall incorporate the following basic features as minimums;
- a) Cards stored on Controller 50,000 with one access level per cardholder
  - b) Cards stored on Controller 25,000 with three access levels per cardholder
  - c) Buffered events shall be a Minimum of 10,000
  - d) Equipment and materials for which there are ETL or UL standard testing requirements,
  - e) A Web based onboard maintenance port which will allow for remote; testing, status reports, rebooting of controller, input and output tests, communication tests as well as the ability to remotely update the controller’s firmware. This Maintenance port will remain operational even when the controller is communicating through the RS-485 port for day to day operation.
  - f) User-defined dry contact relays/outputs with or without supervision

- g) User-defined SPDT dry contacts relays/outputs, shall be a minimum of 2Amps max at 24 VDC or 24 VAC, and be removable and socketed for field replaceability.
  - h) The ACS controller should run in a voltage range of 11.5 VDC to 18 VDC max.
  - I) All inputs and outputs of the ACS Controller shall have an option to be supervised.
  - j) All communication through the Ethernet Port and RS-485 will have AES 256 encryption.
  - k) Provide support for FIPs 201, PIV and CAC Card standards.
  - l) Standard coin battery for real time clock retention.
  - m) Secure SD card (standard type) for door and device configuration, database backup, installation manual, wiring diagrams, as well as remote setup without a network or computer. (Construction Mode)
  - n) The Controller shall have no limit to the number of facilities codes that each will except.
  - o) The controller will have LED indicator's for the following, RS-485 ports, RS-232 ports, network port, relay's (outputs), storage device on controller. Any ACS that does not have these field trouble shooting aids will be considered unacceptable.
10. All database information shall be stored at the controller resulting in decision making being performed at the controller – no degraded mode or facility code mode operation is acceptable.
11. Controllers shall support direct wiring of a 1 or 2 Wiegand output readers without the need for a separate reader interface board, including any proprietary formats that may need to be incorporated into owner's system
12. Controllers shall be compatible with any identification device that transmits data using Weigand, ANSI and Custom ANSI, or other industry standard protocol. This shall include but not limited to Proximity [ALLEGION][HID][AWID][INDALA] [FARPOINTE][Barcode [Name], Magnetic-stripe[Name], Iclass, Corporate 1000, Smart Card [Name], Wiegand Readers, Keypads[Name] and Biometric [Name] readers.
13. Local (server-independent) Anti-Passback per Terminal Controller (TC) and server based global and Soft Anti-Passback supporting up to 20 TC's (40 Readers) per defined zone, each independent of location:
- (1) **Hard** APB Card must be used to exit before it can be used to enter or card must be used to enter before it can be used to exit. If this is out of sequence, access is denied.

- (2) **Zoned** (universal) APB enforcing anti-Passback rules for up to 40 readers or 20 controllers in a defined area.
- (3) **Soft** APB Card must be used to exit before it can be used to enter or card must be used to enter before it can be used to exit. If this is out of sequence, access is granted and a soft anti-passback violation event is posted
- (4) **Timed** APB a time or group of times will automatically reset all APB logic forgiving anyone that may have resulted in an APB violation.

14. The ACS Controller [**AC-1700**]:

- b) System architecture shall provide for controllers to communicate with Legacy controllers via point-to-point RS-485 2 wire, up to 4,000 feet from the Main Controller.
- c) Local APB defined as being server-independent and performed at the entrance and exit point of a single 2-Reader Terminal Controller module.

15. The controllers [**AC-1700**] shall have the capability of being upgraded (flashed) either from host Computer or maintenance port directly to the board

B. Card Reader / Keypad

1. The ACS shall support proximity card, Weigand, magnetic stripe, and barcode technologies to include the following manufacturers:

- a) Sielox Mirage SG, Mirage 2, Performa, and AC-160 Keypad Readers
- b) Integrated Biometric Readers
- c) FIPS 201. PIV, TWIC, CAC and FRAC Readers Standards
- d) Bioscrypt V-Flex, V-Prox V-Pass, V-Smart, and V-Station
- e) ALLEGION Aptiq Readers
- f) HID including; iCLASS, Corporate 1000, BioCLASS, MultiCLASS and Indala
- g) AWID Proximity Readers [26-75] bit
- h) Sentex Passport Readers
- i) Any Weigand formatted Reader, [26-75] bit
- j) Select [**Specified**] barcode Reader
- l) FarPointe Readers

2.

- a) The Allegion AptiQ proximity reader shall be low profile, weatherized and have a read range of up to [five] inches. The reader shall communicate to the controller through a five conductor, stranded, shielded 18 AWG cable

for distances up to 500 feet. The reader shall utilize a [26]-bit Weigand data output and operate at [13.56 MHz]. The reader shall be available in industry standard switch plate size and mullion mount. The reader shall be suitable for indoor and outdoor applications and feature bi-color LED status indicator. The reader shall be powered by 12 VDC, supplied by the controller.

#### C. Access Cards and Key Tags of Fobs

1. The ACS shall be compatible with the following access control cards:
  - a) Sielox Performa - Proximity Plus, Cards and Key Tags/Fobs
  - b) ALLEGION AptiQ – Proximity, Cards and Key Tag/Fobs
  - c) AWID – Proximity, Cards and Key Tags/Fobs
  - d) HID – Proximity, Cards and Key Tags/Fobs
  - e) HID iClass- Contactless Smart Card/Corporate 1000, Cards and Key Tag/Fobs
  - f) Sentex Passport Credentials
  - g) Any Weigand Card or Tag or Fob, 26-75 bit
  - h) US Government Issued, PIV, TWIC, CAC, AND FRAC Credentials
  - i) FarPointe Proximity Cards and Key tags
  
2. Allegion AptiQ Proximity cards shall be approximating the thickness of a standard credit card. The card shall utilize 13.56 MHz operating technology. The card shall be compatible with the ACS manufacturer's card readers. The card shall be available with pre-programmed customer-specific ID numbers and available in clamshell or graphics quality direct print. The graphics-quality direct print card shall also be available in a dual-technology proximity/magnetic stripe card.]

#### I. 4. ACS SOFTWARE PLATFORM

##### A. Basic Functions and Scalability / Expandability

1. The basic functions of the ACS software shall be:
  - a) Access granted, with card, tag, pin, or a combination of several.
  - b) Monitoring of all alarms and card events and general system activity.
  - c) Perform database management tasks like back-up, repair, and maintenance.



- d) Database reporting, including errors and status.
  - e) Device or Controller Status and door lock override and control.
2. The ACS manufacturer shall provide a minimum of four levels of product scalability from entry to enterprise levels. Each low level will be expandable without penalty or the repurchase of an entire system. Any System Manufacture that cannot provide a scalable system to meet the end user's growth will be considered unacceptable.
3. The ACS shall provide straightforward expandability with the following capabilities:
- a) Support for one (1) online readers with maximum unlimited capacity
  - b) Support for one (1) cardholders with a maximum unlimited capacity
  - c) Support an unlimited number of cardholder custom fields
  - d) Support an unlimited number of clients, (thick) and Web (thin) workstations
  - e) Support an unlimited number of hardware communication servers
  - f) Support an unlimited number of addressable controllers
  - g) Support an unlimited number of total access levels and time zones
  - h) Support a maximum of 99 individual expiring access levels per cardholder, each with the ability of having the independent activation dates.
  - i) Support a maximum of 99 alarms levels, each customizable
  - j) Unlimited inputs and outputs, all programmable and customizable
  - k) Unlimited User defined Users (computer operators) Levels
  - l) Support an Unlimited number of Database Partitions
  - m) Support an unlimited number of Allegion – Schlage AD and NDE series locks

## B. Operating System

- A. The ACS shall be a 32-bit Access Control Software, with 64 bit support. ACS shall operate in a client/server or client/database server to hardware server or sever thin client (web based) when configuration on high-quality servers or work station computers running Microsoft Windows Server 2003, 2008, Windows 7, Vista Business, Windows 8.0 / 8.1 Pro, and Windows 10 Professional / Enterprise, operating systems with a Microsoft SQL 2000, 2005, 2008, or 2012 Database. SQL Express will be acceptable for smaller or basic systems.

1. This ACS shall allow the ACS to take full advantage of these and other features inherent in the Microsoft family of products.
2. Operating systems including:
  - a) Multi-operator and multi-threaded (multi-tasking) operation on an open architecture system
  - b) Complete support for most standard networking protocols, including: TCP/IP, UDP
  - c) Graphical operator interface, pull-down menus, mouse and keyboard control, standard Windows type environment

#### C. Database

1. The ACS software shall utilize Microsoft SQL Server 2000, 2005, 2008, 2012 or SQL Express for smaller or basic systems.

#### D. Networking

1. Networking capability shall be necessary to implement large scale and/or multi-location systems with ACS devices including intelligent field controllers and/or remote clients while overall control of the network is maintained at a central location. Local Area Networks (LAN) or Wide Area Networks (WAN) may be required.
2. The ACS shall support IP Tunneling and VPN communications in a multi-cast network environment.
3. A diagnostic utility shall be supplied to allow the operator to verify network communications between a server and workstations or between multiple workstations using LAN topology.
4. The ACS shall support Workstation LAN Disconnect messaging with automatic reconnect options as outlined below:
  - a) When LAN communications with the server is interrupted, a Network Status message shall be displayed at each effected workstation. The dialog box shall be accompanied by a system beep that continues until the "Silence" button is clicked, the ACS is closed or the user logs in, whichever happens first. The ACS shall receive new events or alarms at the workstation while disconnected or while Pinnacle is closed.
1. When LAN communications are restored, the Network Status message shall be updated. A system beep shall accompany the new message with a "Connect" button enabled. Clicking the "Connect" button shall cause the ACS to restart and the user to be prompted to log in again.

#### E. Administration and Operating Features

1. The ACS shall provide an easy-to-operate graphical interface for security operators while performing complex access control, security management and reporting functions. The provided graphical operator interface (GUI) shall be designed following Microsoft Window's guidelines.
2. The features below shall be standard without the need for any add-on software.
  - a) The ACS shall provide interactive on-line help with extensive on-line manual. The on-line manual shall be available to allow the operator to obtain detailed help without having to consult a manual.
  - b) Each workstation shall have access to all features if password level allows. Password levels shall be individually customized to allow or disallow operator access to a program function.
  - c) The operator shall have ability to view and operate up to four independently configured screens simultaneously. Each screen shall be capable of displaying its own title, filter, columns and cardholder image.
  - d) Each workstation shall have the option of having an Alarm Pop-up window appear to alert of pending alarms. The window shall also contain alarm response instructions and a field to enter security console operator comments. The ACS shall have the ability to cascade a maximum of ten Alarm Pop-Up windows per workstation.
  - e) Each workstation shall have the ability to filter alarms, events, and time controlled zones. Users shall be capable of defining alarms, events, and time controlled filters that will be displayed at each workstation. The set-up of an ACS will also allow the ability to trigger an email notification off a filtered event.
  - f) Alarm routing shall be provided so that if an alarm is unacknowledged for a preset amount of time the alarm will automatically appear on another workstation. The system shall provide 99 levels of alarm priority.
  - g) The ACS shall provide a device find feature on the device configuration screen.
  - h) The ACS shall provide for .wav files or system beep to be associated with alarm events for alarm annunciation. The playback frequency of the audible alarms shall be configurable from 1 to 10 times or until the alarm is acknowledged.
  - i) The ACS shall support the ability to perform a lock down via an input and be configurable to control one, many or all doors/locks in the system. When the button is reset, the lock should return to the state it should be in at the time of the reset.
  - j) The ACS shall support the ability to perform a block of any or all readers associated with the lockdown which restricts access to all blocked readers except to those responders assigned a privileged access level.
  - k) The ACS shall support up to 8 privilege cardholders per reader as well as up to 16 privilege access groups per system.

- l) The ACS shall provide the following Input and Output linking:
  - (1) **Local** = I/O linking within the same Controller
  - (2) **Regional** = I/O linking within the same Controller Group [AC-1700's] of controllers
  - (3) **Global** = I/O linking across [AC-1700] Controllers within the same server
  - (4) **Universal** (when using hardware communication servers for enhanced communications)
- m) The ACS shall provide the ability for an access level to shunt on or off an input in response to a card read. The shunt shall be either momentary, toggle or latch.
- n) The ACS shall provide the ability for an access level to activate an output in response to a card read. The output shall activate for the momentary toggle or latch activation time set in the output configuration, and should be able to be controlled with a timezone.
- o) The ACS shall provide n-screen image enhancements that allow color, brightness, and contrast control, along with image cropping, and red eye removal.
- p) The ACS shall provide an Image Library feature that allows up to nine images to be associated with one cardholder record.
- q) The ACS shall automatically activate and deactivate temporary access levels for a cardholder without affecting the cardholder's regular access level.
- r) The ACS shall provide a cardholder quick entry screen that allows the operator to configure and issue a card from that single screen.
- s) The ACS shall provide First Person Rule (FPR, or snow day option), this feature disables the "Time-Unlock" door schedule until an authorized cardholder is admitted prior to the "Timed Unlock.
- t) The ACS shall support entry of card internal identification number in decimal or hexadecimal formats.
- u) The ACS shall support of multiple card formats, across multiple controllers and readers, independently configurable on a per controller [AC-1700] basis, including card only, card + PIN, or ANSI and Custom ANSI format. The following should be pre-programmed for speedy installation of the ACS system:
  - (1) 26-bit Std & 33-bit CKP Weigand
  - (2) 26-bit Std & 33-bit CKP Weigand + Pin
  - (3) ANSI Mag/Custom Weigand
  - (4) HID Corp 1000

## (5) HID Corp 1000 + PIN

- v) The ACS shall provide a library consisting of over 19 standard reports or “canned reports” using formula queries and Boolean statements.
- w) A Crystal reports engine for customization shall allow reports to be tailored to exact requirements of who, what, when, where. The system shall use a Report “wizard” technique to assist the operator in generating all reports. Additional crystal reports license shall not be acceptable.
- x) An Alarms report shall be included with the standard reports offered by the ACS. The report shall give the operator the ability to selectively record new, acknowledged and cleared alarms.
- y) Duress code for card and PIN applications shall allow a cardholder to utilize duress PIN when forced to access a card and PIN door. The duress PIN shall unlock the door and send an alarm event to the operator.
- z) The ACS shall provide a maintenance port password for technicians accessing the ACS controllers so that unauthorized persons do not gain direct serial port access to the controllers.

## I. 5. FIELD QUALITY CONTROL

## B. Installation

1. The contractor shall install all system components and appurtenances in accordance with the manufacturer’s instructions, and shall furnish all necessary interconnections, services, and adjustments required for a complete and operable system as specified and shown. Control signal, communications, and data transmission line grounding shall be installed as necessary to preclude ground loops, noise, and surges from adversely affecting system operation. Provide mounting hardware as required.
2. Coordinate wiring of controlled or monitored doors with owner
3. All low voltage wiring outside the control console, cabinets, boxes, and similar enclosures, shall be plenum rated where required by code. Cable shall not be pulled into conduits or placed in raceways, compartments, outlet boxes, junction boxes, or similar fittings with other building wiring.
4. All inputs shall be protected against surges induced on device wiring. Outputs shall be protected against surges induced on control and device wiring installed outdoors. All communications equipment shall be protected against surges induced on any communications circuit. All cables and conductors, except fiber optics, which serve as communications circuits from security console to field equipment, and between field equipment, shall have surge protection circuits installed at each end.
5. All boxes and enclosures containing security system components and/or cabling and which are easily accessible to employees or to the public shall be provided with a lock. Boxes above ceiling level in occupied areas of the building shall not be considered accessible.

6. All junction boxes and small device enclosures below ceiling level and easily accessible to employees or the public shall be covered with a suitable cover plate and secured with tamper proof screws.
7. All exposed metallic flexible conduit and armored cable shall be dressed down neatly and secured with low profile, metal fasteners.
8. End-of-Line resistors shall be installed at the field device location and/or at the controller panel location.
9. ACS device locations on floor plans are intended to generally indicate areas where such devices are to be located. Security Contractor and Verrill Dana will be responsible for determining final location of these devices in accordance with Owner's requirements.
10. Provide such materials as necessary for a complete and functioning installation. Install in accordance with referenced codes and these specifications. Use weatherproof equipment or covers where installed in areas exposed to weather.
11. Seal penetrations through fire rated construction in accordance with draft stop penetrations in all partitions not required to be fire stopped. Draft stop material shall be pliable and elastic, similar to Dow Corning silicone sealant.
12. Product data submitted shall include manufacturer's documentation that specifically states which circuits are power-limited in accordance with NEC Article 725.
13. Protect cable from damage when passing through building structure or conduit system.

#### C. System Labeling

1. The Contractor shall provide all labeling and numbering required for all components and wiring for the project.
2. All wiring conductors connected to terminal strips shall be individually numbered and each cable or wiring group being extended from a panel or cabinet to a building mounted device shall be identified with the name and number of the particular device as shown.

#### D. System Software

1. The Contractor shall provide the development, loading and checking of the software and/or databases for the complete and proper operation of the systems involved. When the Contractor is required to provide software, it shall be of the most current type and revision. Where licensing of the software is required, the license shall be assigned to the Owner, unless specifically prohibited by the software manufacturer. The Contractor shall provide a copy of the software on media to the Owner prior to system acceptance.
2. Prior to performing any programming, the Contractor shall coordinate with the Owner and shall obtain the Owner's specific programming requirements. The Contractor shall advise the Owner in writing, of the scheduled date for commencement of

programming. The Contractor shall provide the Owner the opportunity to assist in development of programming details.

E. Project Management

1. The Security Contractor shall provide an on-site, factory-trained technician to assist, advise and manage installing personnel.

F. Field Service

1. A Security Contractor, authorized by the manufacturer, shall provide first line support for both hardware and software properties of the selected system.
2. Security Contractor shall in turn be provided second line support directly from the manufacturer, or manufacturer's OEM for all component and computer hardware, and all operating and application software that comprise the complete system.
3. Security Contractor shall determine and report all problems to the manufacturer's customer service departments.
4. Support shall be available to the Security Contractor via the following methods:
  - a) Phone inquiries.
  - b) Direct dial-in to the customer system for remote system troubleshooting by a qualified Field Service Engineer.
  - c) On-site visits if required, upon approval by the manufacturer's Customer Service Manager.
5. Manufacturer shall provide reliable field service support for the computer hardware utilizing
6. Extended and peripheral service and maintenance agreements shall be available for purchase by the customer.

I. 2. TESTING

A. General

1. The contractor shall perform pre-delivery testing, site testing, and adjustment of the completed ACS. The contractor shall provide all personnel, equipment, instrumentation, and supplies necessary to perform all testing. Written notification of planned testing shall be given to the owner at least fourteen (14) days prior to the test, and in no case shall notice be given until after the contractor has received written approval of the specific test procedures. Test procedures shall explain in detail, step-by-step actions and expected results demonstrating compliance with the requirements of the specification. Test reports shall be used to document results of the tests. Reports shall be delivered to the owner within seven (7) days after completion of each test.
2. A factory trained field technician shall perform site tests with the Owner's Representatives in attendance.

3. Tests shall be performed on each circuit and component of each system. Tests shall include, but not be limited to, measurements of power supply output under maximum load, signal loop resistance, and leakage to ground where applicable. System components with battery backup shall be operated on battery power for a period of not less than 10% of the calculated battery operating time. Where testing components requires special or dedicated equipment, the Contractor shall provide the equipment.
4. On any circuit where malfunctions occur, each component within the malfunctioning circuit shall also be retested after the malfunction has been corrected.
5. The Contractor shall continue the test procedures until all devices, sequences are complete and functioning properly, and until all system, testing has been completed.
6. The Contractor shall demonstrate to the Owner's Representative that all sequences operate correctly and that all products, devices and system software operate as designed and specified.
7. Documentation of testing shall be included in the As-built package.

#### B. On-Site Commissioning

1. The manufacturer shall provide direct participation in the on-site commissioning activity of the ACS, in conjunction with the Security Contractor.
2. The manufacturer shall provide the Security Contractor with the expertise on installing, configuring and commissioning of the system to meet the Owner's requirements and to provide onsite training on system operation and administration.
3. The on-site commissioning activity shall include the following:
  - a) Hardware set-up and testing
  - b) Communication configuration and test
  - c) Preventative maintenance and troubleshooting training for the Security Contractor
  - d) End-operator training
  - e) Database configuration and build assistance

#### C. System Acceptance

1. The ACS shall not be considered accepted until all punch list items have been corrected. Beneficial use of part or all of the system shall not be considered as acceptance.

### I. 3. TRAINING

- A. The contractor shall conduct training courses for personnel designated by the owner. Training shall cover the maintenance and operation of the ACS. The training shall be oriented to the specific system being installed under this contract including central processor. Training manuals shall be delivered for each trainee with one additional copy delivered for archiving at the project site. The manuals shall include an agenda, defined



objectives for each lesson, and a detailed description of the subject matter for each lesson. The contractor shall furnish audiovisual equipment and other training materials and supplies as necessary. Where the contractor presents portions of the course by audiovisual material, copies of the audiovisual material shall be delivered to the owner on the same media as that used during the training session. Up to 10 hours of training shall be provided for in the base contract.

- B. Classroom training shall be available to end-operators at the manufacturer's facility. The training shall offer "hands on" instruction that allows each student to perform specific tasks using the ACS. The training shall be structured so that Operators and Administrators of the ACS receive the appropriate level of training. Types of courses offered by the manufacturer shall include: ACS hardware installation and troubleshooting, fundamental of LAN/WAN networking, operations and administration on all ACS applications.
- C. On-site training from the manufacturer shall also be available upon Owner's request.

#### I. 4. SUPPORT AND SERVICE

##### A. Warranty and Support

1. The Security Contractor shall warrant the ACS for one (1) year from the date of final system acceptance.
2. The contractor shall provide all services required and equipment necessary to maintain the entire ACS in an operational state as specified for a period of one (1) year after formal written acceptance of the system, and shall provide all necessary material required for performing scheduled adjustments or other nonscheduled work.
3. The Security Contractor shall be available during the warranty period to answer programming and application questions to support Owner's personnel during this period.
4. Option: The Security Contractor shall have capability to have a remote terminal for programming the intelligent field controller to support the Owner's personnel during the warranty period. The Owner's system shall include a modem, necessary cabling and telephone extension to support this telecommunications operation.

##### B. Service Personnel

1. Service personnel shall be qualified to accomplish all work promptly and satisfactorily. Provide proof that Service personnel have successfully completed the appropriate level of both hardware and software training offered by the system manufacturer. The owner shall be advised in writing of the name of the designated service representative and of any change in personnel.

##### C. Inspections

1. During the warranty period, the Security Contractor shall perform two inspections at six (6) month intervals. This work shall be performed during regular working hours, Monday through Friday, excluding Federal holidays. These inspections shall include:

- a) Visual checks and operational tests of the central processor, local processors, monitors, keyboards, system printers, peripheral equipment, ACS/CCTV equipment, power supplies, and electrical and mechanical controls.
- b) Clean system equipment, including interior and exterior surfaces.
- c) Perform diagnostics on all equipment.
- d) Check and calibrate each ACS/CCTV device.
- e) Run system software and correct diagnosed problems.
- f) Resolve previous outstanding problems.

### PART 3—EXECUTION

#### 3.01. INSPECTION

1. It shall be the general contractor's responsibility to inspect all doors openings and doors to determine that each door and door frame has been properly prepared for the required hardware. If errors in dimensions or preparation are encountered, they are to be corrected by the responsible parties prior to the installation of hardware.

#### 3.02 PREPARATION

1. All doors and frames, requiring field preparation for finish hardware, shall be carefully mortised, drilled for pilot holes, or tapped for machine screws for all items of finish hardware in accordance with the manufacturers templates and instructions.

#### 3.03 INSTALLATION/ADJUSTMENT/LOCATION

1. All materials shall be installed in a workmanlike manner following the manufacture's recommended instructions.
2. Exit Devices shall be carefully installed so as to permit friction free operation of crossbar, touch bar, lever. Latching mechanism shall also operate freely without friction or binding.
3. Door Closers shall be installed in accordance with the manufacturer's instructions. Each door closer shall be carefully installed, on each door, at the degree of opening indicated on the hardware schedule. Arm position shall be shown on the instruction sheets and required by the finish hardware schedule.
4. The adjustments for all door closers shall be the installer's responsibility and these adjustments shall be made at the time of installation of the door closer. The closing speed and the latching speed valves, shall be adjusted individually to provide a smooth, continuous closing action without slamming. The delayed action feature or back check valve shall also be adjusted so as to permit the correct delayed action cycle or hydraulic back check valve shall also be adjusted so as the opening cycle. All valves must be properly adjusted at the time of installation. Each door closer has adjustable spring power capable of being adjusted, in the field from size 2 thru 6. It shall be the installers' responsibility to adjust the spring power for each door closer in exact accordance with the spring power adjustment chart illustrated in the door closer installation sheet packed with

each door closed.

5. Installation of all other hardware, including locksets, push-pull latches, overhead holders, door stops, plates and other items, shall be carefully coordinated with the hardware schedule and the manufacturer's instruction sheets.
6. Locations for finish hardware shall be in accordance with dimensions listed in the pamphlet "Recommended locations for Builders' Hardware" published by the Door and Hardware Institute.

### 3.04 FIELD QUALITY CONTROL

1. Upon completion of the installation of the finish hardware, it shall be the responsibility of the finish hardware supplier to visit the project and to examine the hardware for each door on which he has provided hardware and to verify that all hardware is in proper working order. Should he find items of hardware not operating problem he should make a report, in writing, to the general contractor, advising him of the problem and the measures required to correct the problem.

### 3.05 PROTECTION

1. All exposed portions of finish hardware shall be carefully protected, by use of cloth, adhesive backed paper or other materials, immediately after installation of the hardware item on the door. The finish shall remain protected until completion of the project. Prior to acceptance of the project by the Architect and owner, the general contractor shall remove the protective material exposing the finish hardware.

### 3.06 CLEANING

1. It shall be the responsibility of the general contractor to clean all items of finish hardware and to remove any remaining pieces of protective materials and labels.

### 3.07 INSTRUCTIONS AND TOOLS

1. It shall be the responsibility of the finish hardware supplier to provide installation and repair manuals and adjusting tools, wrenches, etc. for the following operating products.
  - a. Locksets (all types)
  - b. Exit Devices (all types)
  - c. Door Closers

### 3.08 HARDWARE SETS

1. Each Hardware Set listed below represents the complete hardware requirements for one opening. (Single Door or Pair of Doors). Furnish the quantities required for each set for the work.

Doors #700, 701, 702, 704, 706, 710, 712, 714, 716, 718, 719, 720, 721, 725, 750, 752, 756, 754, 749, 755, 855A, 855B, 833, 861, 887, 889

Each Leaf Shall Have: Hinges, Lockset (Function C), Door Stop

HW 2

Doors #707, 819, 820, 972, 1072

Each Leaf Shall Have: Hinges, Lockset (Function H), Door Stop

HW 3

Doors #729, 757A, 757B, 890, 892, 894, 992, 994, 996, 998, 1096A, 1096B, 829, 888A, 888B, 991B, 1084A, 1095, 1097, 1098, 995A, 995B, 945, 1099

Each Leaf Shall Have: Hinges, Lockset (Function D), Door Stop

HW 3B

Doors #899A, 899B, 827

Each Leaf Shall Have: Hinges, Lockset (Function D), Door Closer, Kick Plate, Door Stop

HW 4

Doors #723, 735, 746, 871, 971, 1071, 1084B

Each Leaf Shall Have: Hinges, Lockset (Function A), Door Stop

HW 5

Doors #713, 825, 1064A, 1064B

Each Leaf Shall Have: Hinges, Lockset (Function I, I), Roller Latches, Overhead Stops

HW 6

Doors #8ST-1A, 9ST-1A, 10ST-1A

Each Leaf Shall Have: Hinges, (1) Electric Hinge, Lockset (Function K), Door Closer, Card Reader, Kick Plate, Magnetic Holder (2) Electro Lynx Harness, Power Supplies, Door Stops

HW 6A

Doors #7ST-1A

Each Leaf Shall Have: Hinges, (1) Electric Hinge, Lockset (Function M), Door Closer, (2) Card Readers, Kick Plate, Magnetic Holder (2) Electro Lynx Harness, Power Supplies  
(Electric Lockset Tied to Fire Alarm System to Release on Alarm)

HW 7

Doors #8.05A, 8-05B, 893A, 893B, 9-01B, 9-01C, 990B, 990C, 993A, 993B, 10-01A, 10-01B, 10-05A, 10-05B, 1090A, 1090B, 1093A, 1093B

Each Leaf Shall Have: Hinges, (1) Electric Hinge, Lockset (Function K), Door Closer, Card Reader, Kick Plate, (2) Electro Lynx Harness, Power Supplies

Doors #1090A, 1090B Add Smoke Seals, Astragal Seals

HW 7A

Doors #727A, 7-05B, 7-05A, 8-01A

Each Leaf Shall Have: Hinges, (1) Electric Hinge, Lockset (Function K), Door Closer, Kick Plate, (2) Electro Lynx Harness, Power Supplies

(Re-Use Existing Card Readers)

HW 8

Doors #855C, 990A

Each Leaf Shall Have: Hinges, (2) Electric Hinges, Exit Device (Function V, W), Door Closers (Hold Open Arms), Door Stops, (4) Electro Lynx Harness, Pulls (Type A), Card Reader, Power Supply, Kick Plates

Doors #855C Add Smoke Seals, Astragal Seals

HW 8A

Doors #9-01A

Each Leaf Shall Have: Hinges, (2) Electric Hinges, Exit Device (Function V, W), Door Closers (Hold Open Arms), Door Stops, (4) Electro Lynx Harness, Pulls (Type A), Card Reader, Power Supply, Kick Plates, Smoke Seals, Astragal Seals

HW 9

Doors #919

Each Leaf Shall Have: Hinges, Lockset (Function F), Flush Bolts, Overhead Stops

HW 10

Doors #7-10, 7-11, 8-10, 8-11, 9-10, 9-11, 10-10, 10-11

Each Leaf Shall Have: Hinges, (1) Electric Hinge, Lockset (Function D), Door Closer, Kick Plate, Door Stop

(Prep Doors for Future Card Reader)

HW 11

Doors #7-01A

Each Leaf Shall Have: Hinges, Exit Device (Function T, T), Door Closers, Kick Plates, Magnetic Holders, Smoke Seals, Astragal Smoke Seal, Door Stops

HW 12

Doors #7-01B

Each Leaf Shall Have: Smoke Seals

Issued for Construction

Verrill Dana Interior Renovations  
Portland, Maine  
Project No. 16001

END OF SECTION 087100

## SECTION 088000 - GLAZING

### PART 1 - GENERAL

#### 1.1 SUMMARY

- A. Section includes glazing for the following products and applications, including those specified in other Sections where glazing requirements are specified by reference to this Section:
  - 1. Windows.
  - 2. Doors.
  - 3. Interior borrowed lites.

#### 1.2 PRECONSTRUCTION TESTING

- A. Preconstruction Adhesion and Compatibility Testing: Test each glazing material type, tape sealant, gasket, glazing accessory, and glass-framing member for adhesion to and compatibility with elastomeric glazing sealants.
  - 1. Testing will not be required if data are submitted based on previous testing of current sealant products and glazing materials matching those submitted.

#### 1.3 ACTION SUBMITTALS

- A. Product Data: For each glass product and glazing material indicated.
- B. Glass Samples: For each type of glass product other than clear monolithic vision glass; 12 inches square.
- C. Glazing Schedule: List glass types and thicknesses for each size opening and location. Use same designations indicated on Drawings.

#### 1.4 INFORMATIONAL SUBMITTALS

- A. Preconstruction adhesion and compatibility test report.

#### 1.5 QUALITY ASSURANCE

- A. Glazing Publications: Comply with published recommendations of glass product manufacturers and organizations below, unless more stringent requirements are indicated. Refer to these publications for glazing terms not otherwise defined in this Section or in referenced standards.
  - 1. IGMA Publication for Insulating Glass: SIGMA TM-3000, "North American Glazing Guidelines for Sealed Insulating Glass Units for Commercial and Residential Use."

- B. Safety Glazing Labeling: Where safety glazing labeling is indicated, permanently mark glazing with certification label of the SGCC or another certification agency acceptable to authorities having jurisdiction. Label shall indicate manufacturer's name, type of glass, thickness, and safety glazing standard with which glass complies.
- C. Fire-Protection-Rated Glazing Labeling: Permanently mark fire-protection-rated glazing with certification label of a testing agency acceptable to authorities having jurisdiction. Label shall indicate manufacturer's name, test standard, whether glazing is for use in fire doors or other openings, whether or not glazing passes hose-stream test, whether or not glazing has a temperature rise rating of 450 deg F, and the fire-resistance rating in minutes.
- D. Insulating-Glass Certification Program: Permanently marked either on spacers or on at least one component lite of units with appropriate certification label of IGCC.

## 1.6 WARRANTY

- A. Manufacturer's Special Warranty for Coated-Glass Products: Manufacturer's standard form in which coated-glass manufacturer agrees to replace coated-glass units that deteriorate within specified warranty period. Deterioration of coated glass is defined as defects developed from normal use that are not attributed to glass breakage or to maintaining and cleaning coated glass contrary to manufacturer's written instructions. Defects include peeling, cracking, and other indications of deterioration in coating.
  - 1. Warranty Period: 10 years from date of Substantial Completion.
- B. Manufacturer's Special Warranty on Insulating Glass: Manufacturer's standard form in which insulating-glass manufacturer agrees to replace insulating-glass units that deteriorate within specified warranty period. Deterioration of insulating glass is defined as failure of hermetic seal under normal use that is not attributed to glass breakage or to maintaining and cleaning insulating glass contrary to manufacturer's written instructions. Evidence of failure is the obstruction of vision by dust, moisture, or film on interior surfaces of glass.
  - 1. Warranty Period: 10 years from date of Substantial Completion.

## PART 2 - PRODUCTS

### 2.1 GLASS PRODUCTS, GENERAL

- A. Thickness: Where glass thickness is indicated, it is a minimum. Provide glass lites in thicknesses as needed to comply with requirements indicated.
- B. Strength: Where float glass is indicated, provide annealed float glass, Kind HS heat-treated float glass, or Kind FT heat-treated float glass as needed to comply with "Performance Requirements" Article. Where heat-strengthened glass is indicated, provide Kind HS heat-treated float glass or Kind FT heat-treated float glass as needed to comply with "Performance Requirements" Article. Where fully tempered glass is indicated, provide Kind FT heat-treated float glass.
- C. Thermal and Optical Performance Properties: Provide glass with performance properties



specified, as indicated in manufacturer's published test data, based on procedures indicated below:

1. U-Factors: Center-of-glazing values, according to NFRC 100 and based on LBL's WINDOW 5.2 computer program, expressed as Btu/sq. ft. x h x deg F.
2. Solar Heat-Gain Coefficient and Visible Transmittance: Center-of-glazing values, according to NFRC 200 and based on LBL's WINDOW 5.2 computer program.
3. Visible Reflectance: Center-of-glazing values, according to NFRC 300.

## 2.2 GLASS PRODUCTS

- A. Float Glass: ASTM C 1036, Type I, Quality-Q3, Class I (clear) unless otherwise indicated.
- B. Heat-Treated Float Glass: ASTM C 1048; Type I; Quality-Q3; Class I (clear) unless otherwise indicated; of kind and condition indicated.
- C. Laminated Glass: Two lites of clear glass with clear PVB interlayer.
  1. Shall comply with ASTM 1172 Standard Specification for Laminated Architectural Flat Glass.
  2. Fabricated free of foreign substances and air or glass pockets in autoclave with heat plus pressure.
  3. 5.38 mm laminated thickness (2.5 mm glass/0.38 mm interlayer/2.5 mm glass).
- D. Pyrolytic-Coated, Self-Cleaning, Low-Maintenance Glass: Clear float glass with a coating on first surface having both photocatalytic and hydrophilic properties that act to loosen dirt and to cause water to sheet evenly over the glass instead of beading.
  1. Products: Subject to compliance with requirements, provide one of the following:
    - a. AFG Industries, Inc.; Spotless Ti.
    - b. Cardinal Glass Industries; LoE2 Plus.
    - c. Pilkington North America; Activ.
    - d. PPG Industries, Inc.; SunClean.

## 2.3 INSULATING GLASS

- A. Insulating-Glass Units: Factory-assembled units consisting of sealed lites of glass separated by a dehydrated interspace, qualified according to ASTM E 2190, and complying with other requirements specified.
  1. Sealing System: Dual seal.
  2. Spacer: Manufacturer's standard spacer material and construction.

## 2.4 FIRE-PROTECTION-RATED GLAZING

- A. Fire-Protection-Rated Glazing, General: Listed and labeled by a testing agency acceptable to  
September 21, 2016

authorities having jurisdiction, for fire-protection ratings indicated, based on testing according to NFPA 252 for door assemblies.

- B. Laminated Glass with Intumescent Interlayers: Laminated glass made from multiple plies of uncoated, clear float glass; with intumescent interlayers; complying with testing requirements in 16 CFR 1201 for Category II materials.
  - 1. Products: Subject to compliance with requirements, provide one of the following:
    - a. InterEdge, Inc., a subsidiary of AFG Industries, Inc.; Pyrobel.
    - b. Pilkington Group Limited (distributed by Technical Glass Products); PyroStop.
    - c. Vetrotech Saint-Gobain; SGG Swissflam N2.

## 2.5 GLAZING GASKETS

- A. Dense Compression Gaskets: Molded or extruded gaskets of profile and hardness required to maintain watertight seal, made from one of the following:
  - 1. Neoprene complying with ASTM C 864.
  - 2. EPDM complying with ASTM C 864.
  - 3. Silicone complying with ASTM C 1115.
  - 4. Thermoplastic polyolefin rubber complying with ASTM C 1115.
- B. Soft Compression Gaskets: Extruded or molded, closed-cell, integral-skinned neoprene, EPDM silicone, or thermoplastic polyolefin rubber gaskets complying with ASTM C 509, Type II, black; of profile and hardness required to maintain watertight seal.
  - 1. Application: Use where soft compression gaskets will be compressed by inserting dense compression gaskets on opposite side of glazing or pressure applied by means of pressure-glazing stops on opposite side of glazing.

## 2.6 GLAZING SEALANTS

- A. General:
  - 1. Compatibility: Provide glazing sealants that are compatible with one another and with other materials they will contact, including glass products, seals of insulating-glass units, and glazing channel substrates, under conditions of service and application, as demonstrated by sealant manufacturer based on testing and field experience.
  - 2. Suitability: Comply with sealant and glass manufacturers' written instructions for selecting glazing sealants suitable for applications indicated and for conditions existing at time of installation.
- B. Glazing Sealant: Neutral-curing silicone glazing sealant complying with ASTM C 920, Type S, Grade NS, Class 100/50, Use NT.
- C. Glazing Sealants for Fire-Rated Glazing Products: Products that are approved by testing agencies that listed and labeled fire-resistant glazing products with which they are used for

applications and fire-protection ratings indicated.

## 2.7 GLAZING TAPES

- A. Back-Bedding Mastic Glazing Tapes: Preformed, butyl-based, 100 percent solids elastomeric tape; nonstaining and nonmigrating in contact with nonporous surfaces; with or without spacer rod as recommended in writing by tape and glass manufacturers for application indicated; and complying with ASTM C 1281 and AAMA 800 for products indicated below:
  - 1. AAMA 806.3 tape, for glazing applications in which tape is subject to continuous pressure.
- B. Expanded Cellular Glazing Tapes: Closed-cell, PVC foam tapes; factory coated with adhesive on both surfaces; and complying with AAMA 800 for the following types:
  - 1. AAMA 810.1, Type 1, for glazing applications in which tape acts as the primary sealant.
  - 2. AAMA 810.1, Type 2, for glazing application in which tape is used in combination with a full bead of liquid sealant.

## 2.8 MISCELLANEOUS GLAZING MATERIALS

- A. Cleaners, Primers, and Sealers: Types recommended by sealant or gasket manufacturer.
- B. Setting Blocks: Elastomeric material with a Shore, Type A durometer hardness of 85, plus or minus 5.
- C. Spacers: Elastomeric blocks or continuous extrusions of hardness required by glass manufacturer to maintain glass lites in place for installation indicated.
- D. Edge Blocks: Elastomeric material of hardness needed to limit glass lateral movement (side walking).
- E. Cylindrical Glazing Sealant Backing: ASTM C 1330, Type O (open-cell material), of size and density to control glazing sealant depth and otherwise produce optimum glazing sealant performance.
- F. Perimeter Insulation for Fire-Resistive Glazing: Product that is approved by testing agency that listed and labeled fire-resistant glazing product with which it is used for application and fire-protection rating indicated.

## 2.9 MONOLITHIC-GLASS TYPES

- A. Glass Type: Clear float glass.
  - 1. Thickness: 6.0 mm.
- B. Glass Type: Fully tempered float glass.

1. Thickness: 12.0 mm.
  2. Provide safety glazing labeling.
- C. Glass Type: Pyrolytic-coated, self-cleaning, low-maintenance, clear float glass.
1. Thickness: 6.0 mm.

## 2.10 INSULATING-GLASS TYPES

- A. Glass Type: Low-e-coated, clear insulating glass.
1. Overall Unit Thickness: 1 inch.
  2. Thickness of Each Glass Lite: 6.0 mm.
  3. Outdoor Lite: Fully tempered float glass.
  4. Interspace Content: Air.
  5. Indoor Lite: Float glass.
  6. Low-E Coating: Pyrolytic on second surface.
  7. Provide safety glazing labeling.

## 2.11 FIRE-PROTECTION-RATED GLAZING TYPES

- A. Glass Type: 45-minute fire-rated glazing; laminated glass with intumescent interlayers.
1. Provide safety glazing labeling.
- B. Glass Type: 90 minute fire-rated glazing, laminated glass with intumescent interlayers.
1. Provide safety glazing labeling.

## PART 3 - EXECUTION

### 3.1 GLAZING, GENERAL

- A. Comply with combined written instructions of manufacturers of glass, sealants, gaskets, and other glazing materials, unless more stringent requirements are indicated, including those in referenced glazing publications.
- B. Adjust glazing channel dimensions as required by Project conditions during installation to provide necessary bite on glass, minimum edge and face clearances, and adequate sealant thicknesses, with reasonable tolerances.
- C. Protect glass edges from damage during handling and installation. Remove damaged glass from Project site and legally dispose of off Project site. Damaged glass is glass with edge damage or other imperfections that, when installed, could weaken glass and impair performance and appearance.
- D. Apply primers to joint surfaces where required for adhesion of sealants, as determined by

preconstruction testing.

- E. Install setting blocks in sill rabbets, sized and located to comply with referenced glazing publications, unless otherwise required by glass manufacturer. Set blocks in thin course of compatible sealant suitable for heel bead.
- F. Do not exceed edge pressures stipulated by glass manufacturers for installing glass lites.
- G. Provide spacers for glass lites where length plus width is larger than 50 inches.
- H. Provide edge blocking where indicated or needed to prevent glass lites from moving sideways in glazing channel, as recommended in writing by glass manufacturer and according to requirements in referenced glazing publications.

### 3.2 TAPE GLAZING

- A. Position tapes on fixed stops so that, when compressed by glass, their exposed edges are flush with or protrude slightly above sightline of stops.
- B. Install tapes continuously, but not necessarily in one continuous length. Do not stretch tapes to make them fit opening.
- C. Cover vertical framing joints by applying tapes to heads and sills first and then to jambs. Cover horizontal framing joints by applying tapes to jambs and then to heads and sills.
- D. Place joints in tapes at corners of opening with adjoining lengths butted together, not lapped. Seal joints in tapes with compatible sealant approved by tape manufacturer.
- E. Apply heel bead of elastomeric sealant.
- F. Center glass lites in openings on setting blocks and press firmly against tape by inserting dense compression gaskets formed and installed to lock in place against faces of removable stops. Start gasket applications at corners and work toward centers of openings.
- G. Apply cap bead of elastomeric sealant over exposed edge of tape.

### 3.3 GASKET GLAZING (DRY)

- A. Cut compression gaskets to lengths recommended by gasket manufacturer to fit openings exactly, with allowance for stretch during installation.
- B. Insert soft compression gasket between glass and frame or fixed stop so it is securely in place with joints miter cut and bonded together at corners.
- C. Installation with Drive-in Wedge Gaskets: Center glass lites in openings on setting blocks and press firmly against soft compression gasket by inserting dense compression gaskets formed and installed to lock in place against faces of removable stops. Start gasket applications at corners and work toward centers of openings. Compress gaskets to produce a weathertight seal without developing bending stresses in glass. Seal gasket joints with sealant recommended by gasket manufacturer.

- D. Installation with Pressure-Glazing Stops: Center glass lites in openings on setting blocks and press firmly against soft compression gasket. Install dense compression gaskets and pressure-glazing stops, applying pressure uniformly to compression gaskets. Compress gaskets to produce a weathertight seal without developing bending stresses in glass. Seal gasket joints with sealant recommended by gasket manufacturer.
- E. Install gaskets so they protrude past face of glazing stops.

### 3.4 SEALANT GLAZING (WET)

- A. Install continuous spacers, or spacers combined with cylindrical sealant backing, between glass lites and glazing stops to maintain glass face clearances and to prevent sealant from extruding into glass channel and blocking weep systems until sealants cure. Secure spacers or spacers and backings in place and in position to control depth of installed sealant relative to edge clearance for optimum sealant performance.
- B. Force sealants into glazing channels to eliminate voids and to ensure complete wetting or bond of sealant to glass and channel surfaces.
- C. Tool exposed surfaces of sealants to provide a substantial wash away from glass.

### 3.5 CLEANING AND PROTECTION

- A. Protect exterior glass from damage immediately after installation by attaching crossed streamers to framing held away from glass. Do not apply markers to glass surface. Remove nonpermanent labels and clean surfaces.
- B. Protect glass from contact with contaminating substances resulting from construction operations. If, despite such protection, contaminating substances do come into contact with glass, remove substances immediately as recommended in writing by glass manufacturer.
- C. Examine glass surfaces adjacent to or below exterior concrete and other masonry surfaces at frequent intervals during construction, but not less than once a month, for buildup of dirt, scum, alkaline deposits, or stains; remove as recommended in writing by glass manufacturer.
- D. Remove and replace glass that is broken, chipped, cracked, or abraded or that is damaged from natural causes, accidents, and vandalism, during construction period.

END OF SECTION 088000

## SECTION 088700 – WINDOW FILM

### PART 1 - GENERAL

#### 1.7 SUMMARY

- A. Section includes patterned film

#### 1.8 ACTION SUBMITTALS

- A. Product Data:
  - 1. Preparation instructions and recommendations.
  - 2. Storage and handling requirements and recommendations.
  - 3. Installation methods.
- B. Verification Samples: For each film specified, two samples representing actual film color and pattern.

#### 1.9 INFORMATIONAL SUBMITTALS

- A. Performance Submittals: Provide laboratory data of emissivity and calculated window U-Factors for various outdoor temperatures based upon established calculation procedure defined by the ASHRAE Handbook of Fundamentals, Chapter 29, or Lawrence Berkeley Laboratory Window 5.2 Computer Program

#### 1.10 QUALITY ASSURANCE

- A. Manufacturer Qualifications: All primary products specified in this section will be supplied by a single manufacturer with a minimum of ten years experience.
  - 1. Provide documentation that the adhesive used on the specified films is a Pressure Sensitive Adhesive (PSA).
- B. Installer Qualifications: All products listed in this section are to be installed by a single installer with a minimum of five years demonstrated experience in installing products of the same type and scope as specified.
  - 1. Provide documentation that the installer is authorized by the Manufacturer to perform Work specified in this section.
  - 2. Provide a commercial building reference list of 5 properties where the installer has applied window film. This list will include the following information:
    - a. Name of building.
    - b. The name and telephone number of a management contact.
    - c. Type of glass.
    - d. Type of film.

- e. Amount of film installed.
- f. Date of completion.

- C. Mock-up: Provide a mock-up for evaluation of surface preparation techniques and application workmanship.
  - 1. Finish areas designated by Architect.
  - 2. Do not proceed with remaining work until workmanship, color, and sheen are approved by Architect.
  - 3. Refinish mock-up area as required to produce acceptable work.
  - 4. Approved mock-up may remain as part of the Work.

#### 1.11 DELIVERY, STORAGE AND HANDLING

- A. Store products in manufacturer's unopened packaging until ready for installation.
- B. Store and dispose of hazardous materials, and materials contaminated by hazardous materials, in accordance with requirements of local authorities having jurisdiction.

#### 1.12 PROJECT CONDITIONS

- A. Maintain environmental conditions (temperature, humidity, and ventilation) within limits recommended by manufacturer for optimum results. Do not install products under environmental conditions outside manufacturer's recommended limits.

#### 1.13 WARRANTY

- A. Manufacturer's Warranty:
  - 1. Warranty Period: 5 years from date of Substantial Completion.

### PART 2 - PRODUCTS

#### 2.1 MANUFACTURERS

- A. Acceptable Manufacturer: 3M Window Film, 3M Center Bldg. 0235-02-S-27 ; St. Paul, MN 55144-1000.
- B. Solyx.
- C. Other manufacturers as approved by Architect.

#### 2.2 COMBINATION PATTERNED FILM FOR INTERIOR WINDOW PRIVACY

- A. Basis of Design: 3M Fasara Series.
- B. As selected by Architect from manufacturers full range.



## 2.3 FILM FOR EXTERIOR WINDOW SUN CONTROL

- A. Basis of Design: 3M Night Vision Series.
- B. As selected by Architect from manufacturers full range.

## PART 3 - EXECUTION

### 3.1 EXAMINATION

#### A. Film Examination:

1. If preparation of glass surfaces is the responsibility of another installer, notify Architect in writing of deviations from manufacturer's recommended installation tolerances and conditions.
  - a. Glass surfaces receiving new film should first be examined to verify that they are free from defects and imperfections, which will affect the final appearance.
2. Do not proceed with installation until glass surfaces have been properly prepared and deviations from manufacturer's recommended tolerances are corrected. Prepare surfaces using the methods recommended by the manufacturer for achieving the best result under the project conditions.
3. Commencement of installation constitutes acceptance of conditions.

### 3.2 PREPARATION

- A. Clean surfaces thoroughly prior to installation.
- B. Prepare surfaces using the methods recommended by the manufacturer for achieving the best result for the substrate under the project conditions.
- C. Refer to Manufacturer's installation instructions for methods of preparation for Impact Protection Adhesive or Impact Protection Profile film attachment systems.

### 3.3 INSTALLATION

#### A. Film Installation, General:

1. Install in accordance with manufacturer's instructions.
2. Cut film edges neatly and square at a uniform distance of 1/8 inch (3 mm) to 1/16 inch (1.5 mm) of window sealant. Use new blade tips after 3 to 4 cuts.
3. Spray the slip solution, composed of one capful of baby shampoo or dishwashing liquid to 1 gallon of water, on window glass and adhesive to facilitate proper positioning of film.
4. Apply film to glass and lightly spray film with slip solution.
5. Squeegee from top to bottom of window. Spray slip solution to film and squeegee a second time.

6. Bump film edge with lint-free towel wrapped around edge of a 5-way tool.
7. Upon completion of film application, allow 30 days for moisture from film installation to dry thoroughly, and to allow film to dry flat with no moisture dimples when viewed under normal viewing conditions.
8. If completing an exterior application, check with the manufacturer as to whether edge sealing is required.

#### 3.4 CLEANING AND PROTECTION

- A. Remove left over material and debris from Work area. Use necessary means to protect film before, during, and after installation.
- B. Touch-up, repair or replace damaged products before Substantial Completion.
- C. After application of film, wash film using common window cleaning solutions, including ammonia solutions, 30 days after application. Do not use abrasive type cleaning agents and bristle brushes to avoid scratching film. Use synthetic sponges or soft cloths.

END OF SECTION 088700

## SECTION 092216 - NON-STRUCTURAL METAL FRAMING

### PART 1 - GENERAL

#### 1.1 SUMMARY

A. Section Includes:

1. Non-load-bearing steel framing systems for interior gypsum board assemblies.
2. Suspension systems for interior gypsum ceilings and soffits.

#### 1.2 ACTION SUBMITTALS

- A. Product Data: For each type of product.

### PART 2 - PRODUCTS

#### 2.1 PERFORMANCE REQUIREMENTS

- A. Fire-Test-Response Characteristics: Provide materials and construction identical to those tested according to ASTM E 119.
- B. STC-Rated Assemblies: Provide materials and construction identical to those tested in assembly indicated according to ASTM E 90 and classified according to ASTM E 413.

#### 2.2 FRAMING SYSTEMS

- A. Steel Studs and Runners: ASTM C 645. Use either steel studs and runners or dimpled steel studs and runners of equivalent minimum base-metal thickness.
1. Minimum Base-Metal Thickness: 0.018 inch.
  2. Depth: As indicated on Drawings.
- B. Slip-Type Head Joints: Where indicated, provide one of the following in thickness not less than indicated for studs and in width to accommodate depth of studs:
1. Single Long-Leg Runner System: ASTM C 645 top runner with 2-inch-deep flanges, installed with studs friction fit into top runner and with continuous bridging located within 12 inches of the top of studs to provide lateral bracing.
  2. Double-Runner System: ASTM C 645 top runners, inside runner with 2-inch-deep flanges and fastened to studs, and outer runner sized to friction fit inside runner.
  3. Deflection Track: Steel sheet top runner manufactured to prevent cracking of finishes due to deflection of structure above.

- a. Products: Subject to compliance with requirements, provide one of the following:
  - 1) Dietrich Metal Framing; SLP-TRK Slotted Deflection Track.
  - 2) MBA Building Supplies; FlatSteel Deflection Track.
  - 3) Steel Network Inc. (The); VertiClip SLD Series.
  - 4) Superior Metal Trim; Superior Flex Track System (SFT).
  - 5) Telling Industries; Vertical Slip Track.
  
- C. Firestop Tracks: Manufactured to allow partition heads to expand and contract with movement of the structure while maintaining continuity of fire-resistance-rated assembly indicated; in thickness not less than indicated for studs and in width to accommodate depth of studs.
  1. Products: Subject to compliance with requirements, provide one of the following:
    - a. Fire Trak Corp.; Fire Trak System attached to studs with Fire Trak Posi Klip.
    - b. Grace Construction Products; FlameSafe FlowTrak System.
    - c. Metal-Lite, Inc.; The System.
  
- D. Flat Strap and Backing Plate: Steel sheet for blocking and bracing in length and width indicated.
  1. Minimum Base-Metal Thickness: 0.018 inch.
  
- E. Cold-Rolled Channel Bridging: Steel, 0.053-inch minimum base-metal thickness, with minimum 1/2-inch-wide flanges.
  1. Depth: As indicated on Drawings.
  2. Clip Angle: Not less than 1-1/2 by 1-1/2 inches, 0.068-inch-thick, galvanized steel.
  
- F. Hat-Shaped, Rigid Furring Channels: ASTM C 645.
  1. Minimum Base-Metal Thickness: 0.018 inch.
  2. Depth: 7/8 inch.
  
- G. Resilient Furring Channels: 1/2-inch-deep, steel sheet members designed to reduce sound transmission.
  1. Configuration: Asymmetrical or hat shaped.
  
- H. Cold-Rolled Furring Channels: 0.053-inch uncoated-steel thickness, with minimum 1/2-inch-wide flanges.
  1. Depth: 3/4 inch.
  2. Furring Brackets: Adjustable, corrugated-edge type of steel sheet with minimum uncoated-steel thickness of 0.033 inch.
  3. Tie Wire: ASTM A 641/A 641M, Class 1 zinc coating, soft temper, 0.062-inch-diameter wire, or double strand of 0.048-inch-diameter wire.

- I. Z-Shaped Furring: With slotted or nonslotted web, face flange of 1-1/4 inches, wall attachment flange of 7/8 inch, minimum uncoated-metal thickness of 0.018 inch, and depth required to fit insulation thickness indicated.

## 2.3 SUSPENSION SYSTEMS

- A. Tie Wire: ASTM A 641/A 641M, Class 1 zinc coating, soft temper, 0.062-inch-diameter wire, or double strand of 0.048-inch-diameter wire.
- B. Hanger Attachments to Concrete:
1. Anchors: Capable of sustaining a load equal to 5 times that imposed as determined by ASTM E 488.
    - a. Type: Postinstalled, chemical anchor.
  2. Powder-Actuated Fasteners: Capable of sustaining, a load equal to 10 times that imposed as determined by ASTM E 1190.
- C. Wire Hangers: ASTM A 641/A 641M, Class 1 zinc coating, soft temper, 0.16 inch in diameter.
- D. Flat Hangers: Steel sheet, 1 by 3/16 inch by length indicated.
- E. Carrying Channels: Cold-rolled, commercial-steel sheet with a base-metal thickness of 0.053 inch and minimum 1/2-inch-wide flanges.
1. Depth: As indicated on Drawings.
- F. Furring Channels (Furring Members):
1. Cold-Rolled Channels: 0.053-inch uncoated-steel thickness, with minimum 1/2-inch-wide flanges, 3/4 inch deep.
  2. Steel Studs and Runners: ASTM C 645. Use either steel studs and runners or dimpled steel studs and runners of equivalent minimum base-metal thickness.
    - a. Minimum Base-Metal Thickness: 0.018 inch.
    - b. Depth: As indicated on Drawings.
  3. Hat-Shaped, Rigid Furring Channels: ASTM C 645, 7/8 inch deep.
    - a. Minimum Base-Metal Thickness: 0.018 inch.
  4. Resilient Furring Channels: 1/2-inch-deep members designed to reduce sound transmission.
    - a. Configuration: Asymmetrical or hat shaped.

## 2.4 AUXILIARY MATERIALS

- A. Fasteners for Metal Framing: Of type, material, size, corrosion resistance, holding power, and other properties required to fasten steel members to substrates.
- B. Isolation Strip at Exterior Walls: Provide asphalt saturated organic felt or foam gasket.

## PART 3 - EXECUTION

### 3.1 INSTALLATION, GENERAL

- A. Installation Standard: ASTM C 754.
  - 1. Gypsum Board Assemblies: Also comply with requirements in ASTM C 840 that apply to framing installation.
- B. Install supplementary framing, and blocking to support fixtures, equipment services, heavy trim, grab bars, toilet accessories, furnishings, or similar construction.
- C. Install bracing at terminations in assemblies.
- D. Do not bridge building control and expansion joints with non-load-bearing steel framing members. Frame both sides of joints independently.

### 3.2 INSTALLING FRAMED ASSEMBLIES

- A. Install framing system components according to spacings indicated, but not greater than spacings required by referenced installation standards for assembly types.
- B. Where studs are installed directly against exterior masonry walls or dissimilar metals at exterior walls, install isolation strip between studs and exterior wall.
- C. Install studs so flanges within framing system point in same direction.
- D. Install tracks (runners) at floors and overhead supports. Extend framing full height to structural supports or substrates above suspended ceilings, except where partitions are indicated to terminate at suspended ceilings. Continue framing around ducts penetrating partitions above ceiling.
  - 1. Slip-Type Head Joints: Where framing extends to overhead structural supports, install to produce joints at tops of framing systems that prevent axial loading of finished assemblies.
  - 2. Door Openings: Screw vertical studs at jambs to jamb anchor clips on door frames; install runner track section (for cripple studs) at head and secure to jamb studs.
    - a. Install two studs at each jamb unless otherwise indicated.

- b. Install cripple studs at head adjacent to each jamb stud, with a minimum 1/2-inch clearance from jamb stud to allow for installation of control joint in finished assembly.
    - c. Extend jamb studs through suspended ceilings and attach to underside of overhead structure.
  3. Other Framed Openings: Frame openings other than door openings the same as required for door openings unless otherwise indicated. Install framing below sills of openings to match framing required above door heads.
  4. Fire-Resistance-Rated Partitions: Install framing to comply with fire-resistance-rated assembly indicated and support closures and to make partitions continuous from floor to underside of solid structure.
    - a. Firestop Track: Where indicated, install to maintain continuity of fire-resistance-rated assembly indicated.
  5. Sound-Rated Partitions: Install framing to comply with sound-rated assembly indicated.
- E. Direct Furring:
  1. Attach to concrete or masonry with stub nails, screws designed for masonry attachment, or powder-driven fasteners spaced 24 inches o.c.
- F. Z-Furring Members:
  1. Erect insulation vertically and hold in place with Z-furring members spaced 24 inches o.c.
  2. Except at exterior corners, securely attach narrow flanges of furring members to wall with concrete stub nails, screws designed for masonry attachment, or powder-driven fasteners spaced 24 inches o.c.
  3. At exterior corners, attach wide flange of furring members to wall with short flange extending beyond corner; on adjacent wall surface, screw-attach short flange of furring channel to web of attached channel. At interior corners, space second member no more than 12 inches from corner and cut insulation to fit.
- G. Installation Tolerance: Install each framing member so fastening surfaces vary not more than 1/8 inch from the plane formed by faces of adjacent framing.

### 3.3 INSTALLING SUSPENSION SYSTEMS

- A. Install suspension system components according to spacings indicated, but not greater than spacings required by referenced installation standards for assembly types.
- B. Isolate suspension systems from building structure where they abut or are penetrated by building structure to prevent transfer of loading imposed by structural movement.
- C. Suspend hangers from building structure as follows:

1. Install hangers plumb and free from contact with insulation or other objects within ceiling plenum that are not part of supporting structural or suspension system.
    - a. Splay hangers only where required to miss obstructions and offset resulting horizontal forces by bracing, countersplaying, or other equally effective means.
  2. Where width of ducts and other construction within ceiling plenum produces hanger spacings that interfere with locations of hangers, install supplemental suspension members and hangers in the form of trapezes or equivalent devices.
  3. Do not attach hangers to permanent metal forms. Furnish cast-in-place hanger inserts that extend through forms.
  4. Do not attach hangers to rolled-in hanger tabs of composite steel floor deck.
  5. Do not connect or suspend steel framing from ducts, pipes, or conduit.
- D. Fire-Resistance-Rated Assemblies: Wire tie furring channels to supports.
- E. Installation Tolerances: Install suspension systems that are level to within 1/8 inch in 12 feet measured lengthwise on each member that will receive finishes and transversely between parallel members that will receive finishes.

END OF SECTION 092216



## SECTION 092900 - GYPSUM BOARD

### PART 1 - GENERAL

#### 1.1 SUMMARY

A. Section Includes:

1. Interior gypsum board.

#### 1.2 ACTION SUBMITTALS

- A. Product Data: For each type of product.

### PART 2 - PRODUCTS

#### 2.1 PERFORMANCE REQUIREMENTS

- A. Fire-Resistance-Rated Assemblies: For fire-resistance-rated assemblies, provide materials and construction identical to those tested in assembly indicated according to ASTM E 119 by an independent testing agency.
- B. STC-Rated Assemblies: For STC-rated assemblies, provide materials and construction identical to those tested in assembly indicated according to ASTM E 90 and classified according to ASTM E 413 by an independent testing agency.

#### 2.2 INTERIOR GYPSUM BOARD

- A. Manufacturers: Subject to compliance with requirements, provide products by one of the following:
1. American Gypsum.
  2. CertainTeed Corp.
  3. Georgia-Pacific Gypsum LLC.
  4. National Gypsum Company.
  5. USG Corporation.
- B. Gypsum Wallboard: ASTM C 1396/C 1396M.
1. Thickness: 5/8 inch.
  2. Long Edges: Tapered.
- C. Gypsum Board, Type X: ASTM C 1396/C 1396M.

1. Thickness: 5/8 inch.
  2. Long Edges: Tapered.
- D. Flexible Gypsum Board: ASTM C 1396/C 1396M. Manufactured to bend to fit radii and to be more flexible than standard regular-type gypsum board of same thickness.
1. Thickness: 1/4 inch.
  2. Long Edges: Tapered.
- E. Gypsum Ceiling Board: ASTM C 1396/C 1396M.
1. Thickness: 5/8 inch.
  2. Long Edges: Tapered.
- F. Moisture- and Mold-Resistant Gypsum Board: ASTM C 1396/C 1396M. With moisture- and mold-resistant core and paper surfaces.
1. Core: 5/8 inch, Type X.
  2. Long Edges: Tapered.
  3. Mold Resistance: ASTM D 3273, score of 10.

## 2.3 TRIM ACCESSORIES

- A. Interior Trim: ASTM C 1047.
1. Material: Galvanized or aluminum-coated steel sheet or rolled zinc.
- B. Aluminum Trim: ASTM B 221, Alloy 6063-T5.

## 2.4 JOINT TREATMENT MATERIALS

- A. General: Comply with ASTM C 475/C 475M.
- B. Joint Tape:
1. Interior Gypsum Board: Paper.
- C. Joint Compound for Interior Gypsum Board: For each coat use formulation that is compatible with other compounds applied on previous or for successive coats.

## 2.5 AUXILIARY MATERIALS

- A. Laminating Adhesive: Adhesive or joint compound recommended for directly adhering gypsum panels to continuous substrate.
- B. Sound Attenuation Blankets: ASTM C 665, Type I (blankets without membrane facing).

### PART 3 - EXECUTION

#### 3.1 APPLYING AND FINISHING PANELS

- A. Comply with ASTM C 840.
- B. Examine panels before installation. Reject panels that are wet, moisture damaged, and mold damaged.
- C. Isolate perimeter of gypsum board applied to non-load-bearing partitions at structural abutments, except floors. Provide 1/4- to 1/2-inch-wide spaces at these locations and trim edges with edge trim where edges of panels are exposed. Seal joints between edges and abutting structural surfaces with acoustical sealant.
- D. Install trim with back flanges intended for fasteners, attach to framing with same fasteners used for panels. Otherwise, attach trim according to manufacturer's written instructions.
  - 1. Aluminum Trim: Install in locations indicated on Drawings.
- E. Prefill open joints and damaged surface areas.
- F. Apply joint tape over gypsum board joints, except for trim products specifically indicated as not intended to receive tape.
- G. Gypsum Board Finish Levels: Finish panels to levels indicated below and according to ASTM C 840:
  - 1. Level 1: Ceiling plenum areas, concealed areas, and where indicated.
  - 2. Level 5: At panel surfaces that will be exposed to view unless otherwise indicated.
    - a. Primer and its application to surfaces are specified in other Division 09 Sections.
- H. Protect adjacent surfaces from drywall compound and texture finishes and promptly remove from floors and other non-drywall surfaces. Repair surfaces stained, marred, or otherwise damaged during drywall application.
- I. Remove and replace panels that are wet, moisture damaged, and mold damaged.

END OF SECTION 092900

Issued for Construction

Verrill Dana Interior Renovations  
Portland, Maine  
Project No. 16001

## SECTION 093000 - TILING

### PART 1 GENERAL

#### 1.1 SECTION INCLUDES

- A. Floor and wall tile.
  - 1. ColorBody Porcelain.
  - 2. Trim and Accessories.
  - 3. Setting Materials.

#### 1.2 SUBMITTALS

- A. Product Data: Manufacturer's data sheets on each product to be used, including:
  - 1. Preparation instructions and recommendations.
  - 2. Storage and handling requirements and recommendations.
  - 3. Installation methods.
- B. Shop Drawings: Indicate tile layout, patterns, color arrangement, perimeter conditions, junctions with dissimilar materials, control and expansion joints, thresholds, ceramic accessories, and setting details.
- C. Selection Samples: Samples of actual tiles for selection.
- D. Samples: Mount tile and apply grout on two plywood panels, illustrating pattern, color variations, and grout joint size variations.
- E. Manufacturer's Certificate:
  - 1. Certify that products meet or exceed specified requirements.
  - 2. For each shipment, type and composition of tile provide a Master Grade Certificate signed by the manufacturer and the installer certifying that products meet or exceed the specified requirements of ANSI A137.1.
- F. Maintenance Data: Include recommended cleaning methods, cleaning materials, stain removal methods, and polishes and waxes.

#### 1.3 QUALITY ASSURANCE

- A. Installer Qualifications: Company specializing in performing the work of this section with minimum two years' experience.
- B. Single Source Responsibility: Obtain each type and color of tile from a single source. Obtain each type and color of mortar, adhesive and grout from the same source.

#### 1.4 DELIVERY, STORAGE, AND HANDLING

- A. Deliver and store products in manufacturer's unopened packaging until ready for installation.
- B. Protect adhesives and liquid additives from freezing or overheating in accordance with manufacturer's instructions.

- C. Store tile and setting materials on elevated platforms, under cover and in a dry location and protect from contamination, dampness, freezing or overheating.

## 1.5 ENVIRONMENTAL REQUIREMENTS

- A. Do not install adhesives in an unventilated environment.
- B. Maintain ambient and substrate temperature of 50 degrees F (10 degrees C) during tiling and for a minimum of 7 days after completion.

## 1.6 EXTRA MATERIALS

- A. Provide for Owner's use a minimum of 2 percent of the primary sizes and colors of tile specified, boxed and clearly labeled.

## PART 2 PRODUCTS

### 2.1 MANUFACTURERS

- A. Acceptable Manufacturer: Voguebay Corporation 709 City Center Boulevard, Suite B-104 Newport News, VA 23606.
- B. No Substitutions.

### 2.2 TILE

- A. General: Provide tile that complies with ANSI A137.1 for types, compositions and other characteristics indicated. Provide tile in the locations and of the types colors and pattern indicated on the Drawings and identified in the Schedule and the end of this Section. Tile shall also be provided in accordance with the following:
  1. Factory Blending: For tile exhibiting color variations within the ranges selected under Submittal of samples, blend tile in the factory and package so tile taken from one package shows the same range of colors as those taken from other packages.
  2. Mounting: For factory mounted tile, provide back or edge mounted tile assemblies as standard with the manufacturer, unless otherwise specified.
  3. Factory Applied Temporary Protective Coatings: Where indicated under tile type, protect exposed surfaces of tile against adherence of mortar and grout by pre-coating with a continuous film of petroleum paraffin wax applied hot. Do not coat unexposed tile surfaces.

### 2.1 SETTING MATERIALS

- A. Organic Adhesive: ANSI A136.1, thinset bond type; use Type I in areas subject to prolonged moisture exposure.
- B. Epoxy Adhesive: ANSI A118.3, thinset bond type.
- C. Mortar Bed Materials:
  1. Portland cement: ASTM C150, type 1, gray or white.
  2. Hydrated Lime: ASTM C207, Type S.
  3. Sand: ASTM C144, fine.
  4. Latex additive: As approved.
  5. Water: Clean and potable.

- D. Mortar Bond Coat Materials:
  - 1. Dry-Set Portland Cement type: ANSI A118.1.
  - 2. Latex-Portland Cement type: ANSI A118.4.
  - 3. Epoxy: ANSI A118.3, 100 percent solids.
- E. Standard Grout: Cement grout, sanded or unsanded, as specified in ANSI A118.6; color as selected.
- F. Polymer modified cement grout, sanded or unsanded, as specified in ANSI A118.7; color as selected.
- G. Epoxy Grout: ANSI A118.8, 100 percent solids epoxy grout; color as selected.
- H. Silicone Sealant: Silicone sealant, moisture and mildew resistant type, white; use for shower floors and shower walls.
- I. Cleavage Membrane:
  - 1. No. 15 (6.9 kg) asphalt saturated felt, ASTM D226, Type 1.
  - 2. Polyethylene film, ASTM D4397, 4.0 mil thickness.
- J. Waterproofing Membrane at Floors: Membrane in accordance with ANSI A118.10 and as follows:
  - 1. Chlorinated Polyethylene Sheet with polyester fabric reinforcing.
  - 2. Fabric Reinforced, Fluid-Applied elastomeric membrane.
  - 3. Un-Reinforced, Fluid-Applied elastomeric membrane.
  - 4. Polyethylene Sheet Product.
  - 5. Fabric-Reinforced, Modified-Bituminous Sheet Product.
  - 6. Urethane Waterproofing and Tile-Setting Adhesive Product.
- K. Membrane at Walls: No. 15 (6.9 kg) asphalt saturated felt, ASTM D226, Type 1.
- L. Membrane at Walls: 4 mil (0.1 mm) thick polyethylene film, ASTM D4397.
- M. Membrane at Walls: Reinforced asphalt paper.
- N. Reinforcing Mesh: 2 by 2 inch (50 by 50 mm) size weave of 16/16 wire size; welded fabric, galvanized.
- O. Metal Lath: ASTM C847, Flat expanded diamond mesh, not less than 2.5 lbs/SY, galvanized finish.
- P. Cementitious Backer Board: ANSI A118.9; High density, cementitious, glass fiber reinforced with 2 inch (50 mm) wide coated glass fiber tape for joints and corners:
  - 1. Thickness: 1/4 inch (6 mm).
  - 2. Thickness: 1/2 inch (13 mm).
  - 3. Thickness: 5/8 inch (16 mm).

## PART 3 EXECUTION

### 3.1 EXAMINATION

- A. Verify that wall surfaces are free of substances which would impair bonding of setting materials, smooth and flat within tolerances specified in ANSI A137.1, and are ready to receive tile.

- B. Verify that sub-floor surfaces are dust-free, and free of substances which would impair bonding of setting materials to sub-floor surfaces, and are smooth and flat within tolerances specified in ANSI A137.1.
- C. Verify that concrete sub-floor surfaces are ready for tile installation by testing for moisture emission rate and alkalinity; obtain instructions if test results are not within limits recommended by tile manufacturer and setting materials manufacturer.
- D. Verify that required floor-mounted utilities are in correct location.

### 3.2 PREPARATION

- A. Protect surrounding work from damage.
- B. Remove any curing compounds or other contaminates.
- C. Vacuum clean surfaces and damp clean.
- D. Seal substrate surface cracks with filler. Level existing substrate surfaces to acceptable flatness tolerances.
- E. Install cementitious backer board in accordance with ANSI A108.11 and board manufacturer's instructions. Tape joints and corners, cover with skim coat of dry-set mortar to a feather edge.
- F. Prepare substrate surfaces for adhesive installation in accordance with adhesive manufacturer's instructions.

### 3.3 INSTALLATION - GENERAL

- A. Install tile and grout in accordance with applicable requirements of ANSI A108.1 through A108.13, manufacturer's instructions, and TCA Handbook recommendations.
- B. Lay tile to pattern indicated. Arrange pattern so that a full tile or joint is centered on each wall and that no tile less than 1/2 width is used. Do not interrupt tile pattern through openings.
- C. Cut and fit tile to penetrations through tile, leaving sealant joint space. Form corners and bases neatly. Align floor joints.
- D. Place tile joints uniform in width, subject to variance in tolerance allowed in tile size. Make joints watertight, without voids, cracks, excess mortar, or excess grout.
- E. Form internal angles square and external angles bullnosed.
- F. Install ceramic accessories rigidly in prepared openings.
- G. Install non-ceramic trim in accordance with manufacturer's instructions.
- H. Install thresholds where indicated.
- I. Sound tile after setting. Replace hollow sounding units.
- J. Keep expansion joints free of adhesive or grout. Apply sealant to joints.
- K. Allow tile to set for a minimum of 48 hours prior to grouting.



- L. Grout tile joints. Use standard grout unless otherwise indicated.
- M. Apply sealant to junction of tile and dissimilar materials and junction of dissimilar planes.

### 3.4 INSTALLATION - FLOORS - THIN-SET METHODS

- A. Over exterior concrete substrates, install in accordance with TCA Handbook Method F102, with standard grout.
- B. Over interior concrete substrates, install in accordance with TCA Handbook Method F113, dry-set or latex-portland cement bond coat, with standard grout, unless otherwise indicated.
  - 1. Where waterproofing membrane is indicated, install in accordance with TCA Handbook Method F122, with latex-portland cement grout.
  - 2. Where epoxy bond coat and grout are indicated, install in accordance with TCA Handbook Method F131.
- C. Over wood substrates, install in accordance with TCA Handbook Method F142, with standard grout, unless otherwise indicated.
  - 1. Where epoxy bond coat and grout are indicated, install in accordance with TCA Handbook Method F143.

### 3.5 INSTALLATION - FLOORS - MORTAR BED METHODS

- A. Over exterior concrete substrates, install in accordance with TCA F101, bonded, with standard grout.
- B. Over interior concrete substrates, install in accordance with TCA Handbook Method F111, with cleavage membrane, unless otherwise indicated.
  - 1. Where waterproofing membrane is indicated, with standard grout or no mention of grout type, install in accordance with TCA Handbook Method F121.
  - 2. Where epoxy bond coat and grout are indicated, install in accordance with TCA Handbook Method F132, bonded.
  - 3. Where epoxy or furan grout is indicated, but not epoxy or furan bond coat, install in accordance with TCA Handbook Method F114, with cleavage membrane.
- C. Over wood substrates, install in accordance with TCA Handbook method F141, with standard grout, unless otherwise indicated.
- D. Cleavage Membrane: Lap edges and ends.
- E. Waterproofing Membrane: Install as specified in ANSI A108.13.
- F. Mortar Bed Thickness: 1-1/4 to 2 inch (32 to 51 mm) maximum, unless otherwise indicated.

### 3.6 INSTALLATION - SHOWERS AND BATHTUB WALLS

- A. At tiled shower receptors install in accordance with TCA Handbook Method B415, mortar bed floor, and W244, thin-set over cementitious backer unit walls.
- B. At bathtub walls install in accordance with TCA Handbook Method B412, over cementitious backer units with waterproofing membrane.
- C. Grout with standard grout as specified above.

- D. Seal joints between tile work and other work with sealant specified in Section 07 90 00 - Joint Protection.

### 3.7 INSTALLATION - WALL TILE

- A. Over cementitious backer units on studs, install in accordance with TCA Handbook Method W244, using membrane at toilet rooms.
- B. Over cementitious backer units install in accordance with TCA Handbook Method W223, organic adhesive.
- C. Over gypsum wallboard on wood or metal studs install in accordance with TCA Handbook Method W243, thin-set with dry-set or latex-portland cement bond coat, unless otherwise indicated.
  - 1. Where mortar bed is indicated, install in accordance with TCA Handbook Method W222, one coat method.
  - 2. Where waterproofing membrane is indicated other than at showers and bathtub walls, install in accordance with TCA Handbook Method W222, one coat method.
- D. Over interior concrete and masonry install in accordance with TCA Handbook Method W202, thin-set with dry-set or latex-portland cement bond coat.
- E. Over wood studs without backer install in accordance with TCA Handbook Method W231, mortar bed, with membrane where indicated.
- F. Over metal studs without backer install in accordance with TCA Handbook Method W241, mortar bed, with membrane where indicated.

### 3.8 CLEANING

- A. Clean tile and grout surfaces.

### 3.9 PROTECTION OF FINISHED WORK

- A. Do not permit traffic over finished floor surface for 72 hours after installation.
- B. Cover floors with kraft paper and protect from dirt and residue from other trades.
- C. Where floor will be exposed for prolonged periods cover with plywood or other similar type walkways

### 3.10 SCHEDULE

- A. Floor Tile: T-1
  - 1. Tile Type: Voguebay Travertine Silver Porcelain Tile (Honed) 24" x 24"
  - 2. Grout Color: as determined by Architect from Manufacturer's full selection.
- B. Wall Tile: T-2
  - 1. Tile Type: Voguebay Travertine Silver Porcelain Tile (Polished) 12" x 24"
  - 2. Wall Tile Base: Voguebay Travertine Silver Porcelain Tile (Honed) 6" x 12"
  - 3. Grout Color: as determined by Architect from Manufacturer's full selection.

END OF SECTION 093000

## SECTION 095113 - ACOUSTICAL PANEL CEILINGS

### PART 1 - GENERAL

#### 1.1 SUMMARY

- A. This Section includes acoustical panels and exposed suspension systems for ceilings.

#### 1.2 SUBMITTALS

- A. Product Data: For each type of product indicated.
- B. Coordination Drawings: Drawn to scale and coordinating acoustical panel ceiling installation with hanger attachment to building structure and ceiling mounted items:
- C. Samples: For each exposed finish.
- D. Product test reports.
- E. Research/evaluation reports.
- F. Maintenance data.

#### 1.3 QUALITY ASSURANCE

- A. Acoustical Testing Agency Qualifications: An independent testing laboratory or an NVLAP-accredited laboratory.
- B. Fire-Test-Response Characteristics:
  - 1. Fire-Resistance Characteristics: Where indicated, provide acoustical panel ceilings identical to those of assemblies tested for fire resistance per ASTM E 119 by UL or another testing and inspecting agency acceptable to authorities having jurisdiction.
    - a. Identify materials with appropriate markings of applicable testing and inspecting agency.
  - 2. Surface-Burning Characteristics: Acoustical panels complying with ASTM E 1264 for Class A materials, when tested per ASTM E 84.
    - a. Smoke-Developed Index: 450 or less.
- C. Seismic Standard: Comply with the following:

1. CISCA's Recommendations for Acoustical Ceilings: Comply with CISCA's "Recommendations for Direct-Hung Acoustical Tile and Lay-in Panel Ceilings--Seismic Zones 0-2."
- D. Mockups: Build mockups to verify selections made under sample submittals and to demonstrate aesthetic effects and set quality standards for materials and execution.
  1. Approved mockups may become part of the completed Work if undisturbed at time of Substantial Completion.
- E. Preinstallation Conference: Conduct conference at Project site.

#### 1.4 EXTRA MATERIALS

- A. Furnish extra materials described below that match products installed and that are packaged with protective covering for storage and identified with labels describing contents.
  1. Acoustical Ceiling Panels: Full-size panels equal to 2.0 percent of quantity installed.
  2. Suspension System Components: Quantity of each exposed component equal to 2.0 percent of quantity installed.

### PART 2 - PRODUCTS

#### 2.1 ACOUSTICAL PANEL CEILINGS, GENERAL

- A. Acoustical Panel Standard: Comply with ASTM E 1264.
- B. Metal Suspension System Standard: Comply with ASTM C 635.
- C. Attachment Devices: Size for five times the design load indicated in ASTM C 635, Table 1, "Direct Hung," unless otherwise indicated. Comply with seismic design requirements.
  1. Anchors in Concrete: Expansion anchors fabricated from corrosion-resistant materials, with holes or loops for attaching hangers of type indicated and with capability to sustain, without failure, a load equal to five times that imposed by ceiling construction, as determined by testing per ASTM E 488 or ASTM E 1512 as applicable, conducted by a qualified testing and inspecting agency.
  2. Power-Actuated Fasteners in Concrete: Fastener system of type suitable for application indicated, fabricated from corrosion-resistant materials, with clips or other accessory devices for attaching hangers of type indicated, and with capability to sustain, without failure, a load equal to 10 times that imposed by ceiling construction, as determined by testing per ASTM E 1190, conducted by a qualified testing and inspecting agency.
- D. Wire Hangers, Braces, and Ties: Zinc-coated carbon-steel wire; ASTM A 641/A 641M, Class 1 zinc coating, soft temper.

1. Size: Select wire diameter so its stress at 3 times hanger design load (ASTM C 635, Table 1, "Direct Hung") will be less than yield stress of wire, but provide not less than 0.106-inch-diameter wire.

- E. Seismic perimeter stabilizer bars, seismic struts, and seismic clips.
- F. Metal Edge Moldings and Trim: Type and profile indicated or, if not indicated, manufacturer's standard moldings for edges and penetrations that comply with seismic design requirements; formed from sheet metal of same material, finish, and color as that used for exposed flanges of suspension system runners.

## 2.2 ACOUSTICAL PANELS FOR ACOUSTICAL PANEL CEILING, ACT-1

- A. Basis-of-Design Product: Subject to compliance with requirements, provide Armstrong World Industries, Inc.; Ultima Tegular or a comparable product by one of the following:
  1. Ecophon CertainTeed, Inc.
  2. Tectum Inc.
  3. USG Interiors, Inc.
- B. Classification: Provide fire-resistance-rated panels complying with ASTM E 1264 for type and form as follows:
  1. Type and Form: Type IV, mineral base with membrane-faced overlay; Form 2, water felted; with vinyl overlay on face.
- C. Color: White.
- D. LR: Not less than 0.90.
- E. NRC: Not less than 0.70, Type E-400 mounting per ASTM E 795.
- F. CAC: Not less than 35.
- G. Edge/Joint Detail: Beveled Tegular.
- H. Thickness: 3/4 inch.
- I. Modular Size: 24 by 24 inches.

## 2.3 ACOUSTICAL PANELS FOR ACOUSTICAL PANEL CEILING, ACT-2

- A. Basis-of-Design Product: Subject to compliance with requirements, provide the following product:
  1. Armstrong World Industries, Inc.; Optima Tegular.

- B. Composition: Fiberglass
- C. Surface Texture: Fine
- D. Color: White.
- E. LR: Not less than 0.86.
- F. NRC: Not less than 0.95, Type E-400 mounting per ASTM E 795.
- G. Edge/Joint Detail: Square Lay-In for interface with compatible Armstrong grid.
- H. Thickness: 1 inch.
- I. Modular Size: 24 by 24 inches.

#### 2.4 METAL SUSPENSION SYSTEM FOR ACOUSTICAL PANEL CEILING

- A. Basis-of-Design Product: Subject to compliance with requirements, provide Armstrong World Industries, Inc.; Prelude ML or a comparable product by one of the following:
  - 1. BPB USA.
  - 2. Chicago Metallic Corporation.
  - 3. Ecophon CertainTeed, Inc.
  - 4. USG Interiors, Inc.
- B. Double-Web, Fire-Rated Steel Suspension System: Main and cross runners roll formed from cold-rolled steel sheet, prepainted, electrolytically zinc coated, or hot-dip galvanized according to ASTM A 653/A 653M, not less than G30 coating designation, with prefinished 15/16-inch-wide metal caps on flanges.
  - 1. Structural Classification: Intermediate -duty system.
  - 2. End Condition of Cross Runners: Override (stepped) or butt-edge type.
  - 3. Cap Material: Steel or aluminum cold-rolled sheet.
  - 4. Cap Finish: Painted white.

#### 2.5 PERIMETER TRIM FOR ACOUSTICAL PANEL CEILING

- A. Basis-of-Design Product: Subject to compliance with requirements, provide Armstrong World Industries, Inc.; Axiom Classic Trim or a comparable product by one of the following:
  - 1. BPB USA.
  - 2. Chicago Metallic Corporation.
  - 3. Ecophon CertainTeed, Inc.
  - 4. USG Interiors, Inc.
- B. Aluminum extrusions formed with distinct architectural detail groove on top and bottom flanges and special bosses to receive the T-bar connection clip, hanging clip, and splice plate, to provide

mechanical lock with no visible fasteners. Factory finished to match approved samples. Factory or field cut, mitered, and curved to match approved shop drawings.

- C. Factory-mitered inside and outside corner pieces are created to match perimeter trim.

## PART 3 - EXECUTION

### 3.1 INSTALLATION

- A. Comply with ASTM C 636 and seismic design requirements indicated, per manufacturer's written instructions and CISCA's "Ceiling Systems Handbook."
- B. Measure each ceiling area and establish layout of acoustical panels to balance border widths at opposite edges of each ceiling. Avoid using less-than-half-width panels at borders.
- C. Suspend ceiling hangers from building's structural members, plumb and free from contact with insulation or other objects within ceiling plenum. Splay hangers only where required and, if permitted with fire-resistance-rated ceilings, to miss obstructions; offset resulting horizontal forces by bracing, countersplaying, or other equally effective means. Where width of ducts and other construction within ceiling plenum produces hanger spacings that interfere with location of hangers, use trapezes or equivalent devices. When steel framing does not permit installation of hanger wires at spacing required, install carrying channels or other supplemental support for attachment of hanger wires.
  - 1. Do not support ceilings directly from permanent metal forms or floor deck; anchor into concrete slabs.
  - 2. Do not attach hangers to steel deck tabs.
- D. Install edge moldings and trim of type indicated at perimeter of acoustical ceiling area and where necessary to conceal edges of acoustical panels. Screw attach moldings to substrate at intervals not more than 16 inches o.c. and not more than 3 inches from ends, leveling with ceiling suspension system to a tolerance of 1/8 inch in 12 feet. Miter corners accurately and connect securely.
- E. Install suspension system runners so they are square and securely interlocked with one another. Remove and replace dented, bent, or kinked members.
- F. Install acoustical panels with undamaged edges and fit accurately into suspension system runners and edge moldings. Scribe and cut panels at borders and penetrations to provide a neat, precise fit.

END OF SECTION 095113

Issued for Construction

Verrill Dana Interior Renovations  
Portland, Maine  
Project No. 16001



## SECTION 095426 – SUSPENDED WOOD CEILINGS

### PART 1 - GENERAL

#### 1.1 SUMMARY

- A. Section includes strip, linear solid wood and wood veneer ceiling panels and suspension systems for ceilings.

#### 1.2 COORDINATION

- A. Coordinate layout and installation of linear wood panels and suspension system with other construction that penetrates ceilings or is supported by them, including light fixtures, HVAC equipment, fire-suppression system, and partition assemblies.

#### 1.3 ACTION SUBMITTALS

- A. Product Data: For each type of product.
- B. Samples: For each exposed finish.
- C. Shop Drawings: Illustrating the layout and details of the ceilings. Show locations of items that are to be coordinated with or supported by the ceilings.

#### 1.4 INFORMATIONAL SUBMITTALS

- A. Product test reports.
- B. Evaluation reports.

#### 1.5 CLOSEOUT SUBMITTALS

- A. Maintenance Data: For finishes to include in maintenance manuals.
- B. Warranty: Submit a written warranty executed by the manufacturer, agreeing to repair or replace panels that fail within the warranty period.

#### 1.6 QUALITY ASSURANCE

- A. Subcontractor Qualifications: Installer shall have not less than three years of successful experience in the installation of ceiling suspension systems on projects with requirements similar to requirements specified.

- B. Single-Source Responsibility: Provide ceiling panel units and support system from a single manufacturer.
- C. Pre-Installation conference: Conduct conference at Project site to comply with requirements in Division 1 Section "Project Management and Coordination."

#### 1.7 DELIVERY, STORAGE, AND HANDLING

- A. Storage: Store the wood veneer ceiling panels in a dry interior location in their cartons prior to installation to avoid damage. Store the ceiling panel cartons in a flat, horizontal position. Do not remove the protectors between the panels until installation. Do not store in unconditioned spaces with humidity greater than 55 percent or lower than 25 percent relative humidity and temperatures lower than 50 degrees F or greater than 86 degrees F. Do not expose the wood veneer ceiling panels to extreme temperatures, for example, close to a heating source or near a window with direct sunlight.
- B. Handling: Handle ceiling units carefully to avoid chipped edges or damage to units in any way.

#### 1.8 PROJECT CONDITIONS

- A. Building Conditions: Prior to installation, the wood veneer ceiling materials are required to reach room temperature and have stabilized moisture content for a minimum of 72 hours. Do not install the wood veneer panels in spaces where the temperature or humidity conditions vary greatly from the temperatures and conditions that will be normal in the occupied space.
- B. Interior temperature/humidity of building: As interior finish products, the wood veneer panels are designed for installation in temperature conditions between 50 degrees F and 86 degrees F, in spaces where the building is enclosed and HVAC systems are functioning and will be in continuous operation. Relative humidity should not fall below 25 percent or exceed 55 percent.

#### 1.9 MAINTENANCE

- A. Extra Materials: Deliver extra materials to Owner. Furnish extra materials described below that match products installed. Packaged with protective covering for storage and identified with appropriate labels.
  1. Ceiling Units: Furnish quantity of full-size units equal to 5.0 percent of amount installed.
  2. Exposed Suspension System Components: Furnish quantity of each exposed suspension component equal to 2.0 percent of amount installed.

### PART 2 - PRODUCTS

#### 2.1 PERFORMANCE REQUIREMENTS

- A. Surface-Burning Characteristics: Comply with ASTM E 84; testing by a qualified testing agency. Identify products with appropriate markings of applicable testing agency.

1. Flame-Spread Index: Comply with ASTM E 1264 for Class A materials.
2. Smoke-Developed Index: 50 or less.

## 2.2 MANUFACTURERS

- A. Armstrong World Industries, Inc.
- B. Equal as Approved by Architect.

## 2.3 WOOD VENEER CEILING UNITS

- A. Basis of Design: Woodworks Linear Veneered Planks.
  1. Texture Surface: Smooth.
  2. Composition: Fire-retardant Particle Board.
  3. Species/Finish: Dark Cherry.
  4. Size: 5 ¼ inches x 96 inches.
  5. Reveal: Square

## 2.4 METAL SUSPENSION SYSTEM

- A. Suspension System: Provide ceiling manufacturer's standard metal suspension systems of types and finishes indicated that comply with applicable ASTM C 635/C 635M requirements.
  1. Carriers: 12 foot Heavy Duty for 6" modules.
  2. Infill Panel: Bio-Acoustic, Black-Matte.
  3. Radius Clip: for curved applications.
  4. Splice Plate: for connecting lengths of carrier.
  5. Hanger Wire: 12 Gage.
  6. Additional Accessories: as required for complete installation.

## PART 3 – EXECUTION

### 3.1 EXAMINATION

- A. Do not proceed with installation until all work such as concrete, terrazzo, plastering, and painting has been completed and thoroughly dried out.
- B. Proper designs for both supply air and return air, maintenance of the HVAC filters and building interior space are essential to minimize soiling. Before starting the HVAC system, make sure supply air is properly filtered and the building interior is free of construction dust.

### 3.2 PREPARATION

- A. Measure each ceiling area and establish layout of acoustical units to balance border widths at

opposite edges of each ceiling. Avoid use of less than half width units at borders, and comply with reflected ceiling plans. Coordinate panel layout with mechanical and electrical fixtures.

### 3.3 INSTALLATION

- A. Comply with ASTM C 636/C 636M and seismic requirement indicated, per manufacturer's written instructions and CISCA's "Ceiling Systems Handbook."
- B. Suspend ceiling hangers from building's structural members and as follows:
  - 1. Install hangers plumb and free from contact with insulation or other objects within ceiling plenum.
  - 2. Splay hangers only where required to miss obstructions; offset resulting horizontal forces by bracing, countersplaying, or other equally effective means.
  - 3. Where width of ducts and other construction within ceiling plenum produces hanger spacings that interfere with location of hangers at spacings required, install trapezes or equivalent devices.
  - 4. Do not support ceilings directly from permanent metal forms or floor deck. Fasten hangers to cast-in-place hanger inserts, postinstalled mechanical or adhesive anchors, or power-actuated fasteners that extend through forms into concrete.
  - 5. When steel framing does not permit installation of hanger wires at spacing required, install carrying channels or other supplemental support for attachment of hanger wires.
  - 6. Do not attach hangers to steel deck tabs or to steel roof deck.
- C. Install suspension system carriers so they are aligned and securely interlocked with one another. Remove and replace dented, bent, or kinked members.
- D. Cut linear wood ceiling planks for accurate fit at borders and at interruptions and penetrations by other work through ceilings.
- E. Install wood ceiling planks in coordination with suspension system and exposed moldings and trim.
  - 1. Align joints in adjacent courses to form uniform, straight joints parallel to room axis in both directions unless otherwise indicated.
  - 2. Fit adjoining units to form flush, tight joints. Scribe and cut units for accurate fit at borders and around construction penetrating ceiling.

### 3.4 ADJUSTING AND CLEANING

- A. Replace damaged and broken panels.
- B. Clean exposed surfaces of ceilings panels, including trim, edge moldings, and suspension members. Comply with manufacturer's instructions for cleaning and touch up of minor finish damage. Remove and replace work that cannot be successfully cleaned and repaired to permanently eliminate evidence of damage.

END OF SECTION 095426

## SECTION 096513 - RESILIENT BASE AND ACCESSORIES

### PART 1 - GENERAL

#### 1.1 SUMMARY

A. Section Includes:

1. Resilient base.
2. Resilient molding accessories.

#### 1.2 ACTION SUBMITTALS

- A. Product Data: For each type of product indicated.
- B. Samples: For each type of product indicated, in manufacturer's standard-size Samples but not less than 12 inches long, of each resilient product color, texture, and pattern required.

#### 1.3 MAINTENANCE MATERIAL SUBMITTALS

- A. Furnish extra materials that match products installed and that are packaged with protective covering for storage and identified with labels describing contents.
1. Furnish not less than 10 linear feet for every 500 linear feet or fraction thereof, of each type, color, pattern, and size of resilient product installed.

#### 1.4 QUALITY ASSURANCE

- A. Fire-Test-Response Characteristics: As determined by testing identical products according to ASTM E 648 or NFPA 253 by a qualified testing agency.
1. Critical Radiant Flux Classification: Class I, not less than 0.45 W/sq. cm.

#### 1.5 PROJECT CONDITIONS

- A. Maintain ambient temperatures within range recommended by manufacturer in spaces to receive resilient products.
- B. Until Substantial Completion, maintain ambient temperatures within range recommended by manufacturer.

- C. Install resilient products after other finishing operations, including painting, have been completed.

## PART 2 - PRODUCTS

### 2.1 RESILIENT BASE

#### A. Resilient Base:

- 1. Manufacturers: Subject to compliance with requirements, provide products by one of the following:
  - a. Johnsonite.
  - b. Armstrong World Industries, Inc.
  - c. Roppe Corporation, USA.

#### B. Resilient Base Standard: ASTM F 1861.

- 1. Material Requirement: Type TV (vinyl, thermoplastic).
- 2. Manufacturing Method: Group I (solid, homogeneous).
- 3. Style: Cove (base with toe).

#### C. Minimum Thickness: 0.080 inch.

#### D. Height: 4 inches.

#### E. Lengths: Coils in manufacturer's standard length.

#### F. Outside Corners: Job formed or preformed.

#### G. Inside Corners: Job formed or preformed.

#### H. Finish: As selected by Architect from manufacturer's full range.

#### I. Colors and Patterns (basis of design):

- a. VB-1 Johnsonite #76 CINNAMON
- b. VB-2 Johnsonite #195 ASH WG

### 2.2 RESILIENT MOLDING ACCESSORY

#### A. Resilient Molding Accessory:

- 1. Manufacturers: Subject to compliance with requirements, provide products by one of the following:
  - a. Burke Mercer Flooring Products; Division of Burke Industries, Inc.
  - b. Flexco, Inc.

- c. Johnsonite.
- d. R.C.A. Rubber Company (The).
- e. Roppe Corporation, USA.
- f. VPI, LLC; Floor Products Division.

- B. Description: Cap for cove carpet.
- C. Material: Vinyl.
- D. Profile and Dimensions: As indicated.
- E. Colors and Patterns: As indicated by manufacturer's designations.

### 2.3 INSTALLATION MATERIALS

- A. Trowelable Leveling and Patching Compounds: Latex-modified, portland cement based or blended hydraulic-cement-based formulation provided or approved by manufacturer for applications indicated.
- B. Adhesives: Water-resistant type recommended by manufacturer to suit resilient products and substrate conditions indicated.
- C. Metal Edge Strips: Extruded aluminum with mill finish of width shown, of height required to protect exposed edges of tiles, and in maximum available lengths to minimize running joints.

## PART 3 - EXECUTION

### 3.1 PREPARATION

- A. Prepare substrates according to manufacturer's written instructions to ensure adhesion of resilient products.
- B. Fill cracks, holes, and depressions in substrates with trowelable leveling and patching compound and remove bumps and ridges to produce a uniform and smooth substrate.
- C. Do not install resilient products until they are same temperature as the space where they are to be installed.
  - 1. Move resilient products and installation materials into spaces where they will be installed at least 48 hours in advance of installation.
- D. Sweep and vacuum clean substrates to be covered by resilient products immediately before installation.

### 3.2 RESILIENT BASE INSTALLATION

- A. Comply with manufacturer's written instructions for installing resilient base.

- B. Apply resilient base to walls, columns, pilasters, casework and cabinets in toe spaces, and other permanent fixtures in rooms and areas where base is required.
- C. Install resilient base in lengths as long as practicable without gaps at seams and with tops of adjacent pieces aligned.
- D. Tightly adhere resilient base to substrate throughout length of each piece, with base in continuous contact with horizontal and vertical substrates.
- E. Do not stretch resilient base during installation.

### 3.3 RESILIENT ACCESSORY INSTALLATION

- A. Comply with manufacturer's written instructions for installing resilient accessories.
- B. Resilient Molding Accessories: Butt to adjacent materials and tightly adhere to substrates throughout length of each piece. Install reducer strips at edges of carpet that would otherwise be exposed.

### 3.4 CLEANING AND PROTECTION

- A. Comply with manufacturer's written instructions for cleaning and protection of resilient products.
- B. Cover resilient products until Substantial Completion.

END OF SECTION 096513



## SECTION 096516 - RESILIENT SHEET FLOORING

### PART 1 - GENERAL

#### 1.1 SUMMARY

A. Section Includes:

1. Resilient Homogeneous Vinyl Sheet Flooring

#### 1.2 ACTION SUBMITTALS

- A. Product Data: For each type of product indicated.
- B. Shop Drawings: For each type of floor covering. Include floor covering layouts, locations of seams, edges, columns, doorways, enclosing partitions, built-in furniture, cabinets, and cutouts.
- C. Samples: In manufacturer's standard size, but not less than 6-by-9-inch sections of each different color and pattern of floor covering required.

#### 1.3 CLOSEOUT SUBMITTALS

- A. Maintenance data.

#### 1.4 QUALITY ASSURANCE

- A. Fire-Test-Response Characteristics: As determined by testing identical products according to ASTM E 648 or NFPA 253 by a qualified testing agency.
1. Critical Radiant Flux Classification: Class I, not less than 0.45 W/sq. cm.

#### 1.5 PROJECT CONDITIONS

- A. Maintain ambient temperatures within range recommended by manufacturer in spaces to receive floor coverings.
- B. Until Substantial Completion, maintain ambient temperatures within range recommended by manufacturer.
- C. Close spaces to traffic during floor covering installation.
- D. Close spaces to traffic for 48 hours after floor covering installation.
- E. Install floor coverings after other finishing operations, including painting, have been completed.

## PART 2 - PRODUCTS

### 2.1 HOMOGENEOUS VINYL SHEET FLOOR COVERING, RF-1

- A. Products: Subject to compliance with requirements, provide the following:
  - 1. Manufacturer: Johnsonite 16910 Munn Road, Chagrin Falls, Ohio 44023.
  - 2. Product: Tarkett iQ GRANIT MICRO.
  - 3. Color: #354 GUSTER.
- B. Polyurethane Reinforced Homogeneous Vinyl Sheet Floor Covering: ASTM F 1913, 0.080 inch thick.
- C. Sheet Width: 6 feet 6 inch nominal.

### 2.2 INSTALLATION MATERIALS

- A. Trowelable Leveling and Patching Compounds: Latex-modified, portland cement based or blended hydraulic-cement-based formulation provided or approved by manufacturer for applications indicated.
- B. Adhesives: Water-resistant type recommended by manufacturer to suit floor covering and substrate conditions indicated.

## PART 3 - EXECUTION

### 3.1 PREPARATION

- A. Prepare substrates according to manufacturer's written instructions to ensure adhesion of floor coverings.
- B. Concrete Substrates: Prepare according to ASTM F 710.
  - 1. Verify that substrates are dry and free of curing compounds, sealers, and hardeners.
  - 2. Remove substrate coatings and other substances that are incompatible with adhesives and that contain soap, wax, oil, or silicone, using mechanical methods recommended by manufacturer. Do not use solvents.
  - 3. Alkalinity and Adhesion Testing: Perform tests recommended by manufacturer. Proceed with installation only after substrates pass testing.
  - 4. Moisture Testing: Perform tests recommended by manufacturer. Proceed with installation only after substrates pass testing.
- C. Fill cracks, holes, and depressions in substrates with trowelable leveling and patching compound and remove bumps and ridges to produce a uniform and smooth substrate.
- D. Do not install floor coverings until they are same temperature as space where they are to be

installed.

1. Move floor coverings and installation materials into spaces where they will be installed at least 48 hours in advance of installation.
- E. Sweep and vacuum clean substrates to be covered by floor coverings immediately before installation.

### 3.2 FLOOR COVERING INSTALLATION

- A. Comply with manufacturer's written instructions for installing floor coverings.
- B. Unroll floor coverings and allow them to stabilize before cutting and fitting.
- C. Lay out floor coverings as follows:
1. Maintain uniformity of floor covering direction.
  2. Minimize number of seams; place seams in inconspicuous and low-traffic areas, at least 6 inches away from parallel joints in floor covering substrates.
  3. Match edges of floor coverings for color shading at seams.
  4. Avoid cross seams.
- D. Scribe and cut floor coverings to butt neatly and tightly to vertical surfaces, permanent fixtures, and built-in furniture including cabinets, pipes, outlets, and door frames.
- E. Extend floor coverings into toe spaces, door reveals, closets, and similar openings.
- F. Maintain reference markers, holes, or openings that are in place or marked for future cutting by repeating on floor coverings as marked on substrates. Use chalk or other nonpermanent marking device.
- G. Adhere floor coverings to substrates using a full spread of adhesive applied to substrate to produce a completed installation without open cracks, voids, raising and puckering at joints, telegraphing of adhesive spreader marks, and other surface imperfections.

### 3.3 CLEANING AND PROTECTION

- A. Comply with manufacturer's written instructions for cleaning and protection of floor covering.
- B. Cover floor coverings until Substantial Completion.

END OF SECTION 096516

Issued for Construction

Verrill Dana Interior Renovations  
Portland, Maine  
Project No. 16001

## SECTION 096570 - RESILIENT TILE FLOORING

### PART 1 - GENERAL

#### 1.1 SUMMARY

A. Section Includes:

1. Heavy duty luxury vinyl tile flooring.

#### 1.2 ACTION SUBMITTALS

- A. Product Data: For each type of product indicated.
- B. Samples: For each type of produce indicated, in manufacturer's standard-size samples of each resilient product color, texture, and pattern required.
- C. Shop Drawings: Submit shop drawings showing layout, profiles and product components, including drain details, accessories, finish colors, patterns and textures.

#### 1.3 CLOSEOUT SUBMITTALS

- A. Maintenance data: Include methods for maintaining installed products and precautions against cleaning materials and methods detrimental to finishes and performance.
- B. Warranty: Manufacturer's standard warranty

#### 1.4 QUALITY ASSURANCE

- A. Source Quality: Obtain flooring products from a single manufacturer.
- B. Installer Qualifications: Experienced in performing work of this section and who is specialized in the installation of work similar to that required for this project.
- C. Mock-ups: Install at project site a job mock-up using acceptable products and manufacturer approved installation methods, including concrete substrate testing. Obtain Owner's and Consultant's acceptance of finish color, texture and pattern, and workmanship standards.
- D. Pre-Installation Meeting: Conduct pre-installation meeting to verify project requirements, substrate conditions, manufacturer's installation instructions and manufacturer's warranty requirements.

## 1.5 PROJECT CONDITIONS

- A. Maintain ambient temperatures within range recommended by manufacturer in spaces to receive floor coverings. If storage temperature is below 68F (20C), move the tile to a warmer place and allow to reach this temperature before installation. Maintain temperature of installation area between 68F (20C) and 80F (26C) for a period of at least 72 hours prior to, during, and after completion of the installation for acrylic adhesives (12 hours after completion for polyurethane adhesives).
- B. Until Substantial Completion, maintain ambient temperatures within range recommended by manufacturer.
- C. Close spaces to traffic during floor covering installation.
- D. Close spaces to traffic for 48 hours after floor covering installation.
- E. Install floor coverings after other finishing operations, including painting, have been completed.

## PART 2 - PRODUCTS

### 2.1 RESILIENT TILE FLOORING, LVT

- A. Vinyl Luxury Tile
  - 1. Basis of Design: Kolay Luxury Vinyl Flooring
  - 2. Approved Equal
- B. Product:
  - 1. 420APL Apple
  - 2. Size: 9 inches by 48 inches plank.

### 2.2 ACCESSORIES

- A. Proprietary Accessory Products: Provide manufacturer's accessories for use with manufacturer's tiles.
  - 1. Adhesive: Provide tile manufacturer's proprietary adhesive.

## PART 3 - EXECUTION

### 3.1 EXAMINATION

- A. Examine substrates, with Installer present, for compliance with requirements for installation tolerances, moisture content and other conditions affecting performance.

1. Verify that finishes of substrates comply with tolerances and other requirements specified in other Sections and that substrates are free of cracks , ridges, depressions, scale, and foreign deposits that might interfere with adhesion of resilient products.
- B. Proceed with installation only after unsatisfactory conditions have been corrected.

### 3.2 PREPARATION

- A. Prepare substrates according to manufacturer's written instructions to ensure adhesion of floor coverings.
- B. Concrete Substrates: Prepare according to ASTM F 710.
  1. Verify that substrates are dry and free of curing compounds, sealers, and hardeners.
  2. Remove substrate coatings and other substances that are incompatible with adhesives and that contain soap, wax, oil, or silicone, using mechanical methods recommended by manufacturer. Do not use solvents.
  3. Alkalinity and Adhesion Testing: Perform tests recommended by manufacturer. Proceed with installation only after substrates pass testing.
  4. Moisture Testing: Perform tests recommended by manufacturer. Proceed with installation only after substrates pass testing.
- C. Fill cracks, holes, and depressions in substrates with trowelable leveling and patching compound and remove bumps and ridges to produce a uniform and smooth substrate.
- D. Do not install floor coverings until they are same temperature as space where they are to be installed.
  1. Move floor coverings and installation materials into spaces where they will be installed at least 48 hours in advance of installation.
- E. Sweep and vacuum clean substrates to be covered by floor coverings immediately before installation.

### 3.3 RESILIENT TILE FLOOR INSTALLATION GENERAL

- A. Comply with manufacturer's written instructions for installing floor coverings.
- B. Scribe, cut, and fit floor covering to butt neatly and tightly to vertical surfaces and permanent fixtures including built-in furniture, cabinets, pipes, outlets, edgings, door frames, thresholds, and nosings.
- C. Extend floor covering into toe spaces, door reveals, closets, and similar openings.
- D. Maintain reference markers, holes, and openings that are in place or marked for future cutting by repeating on floor covering as marked on substrates. Use chalk or other nonpermanent, nonstaining marking device.
- E. Adhere floor coverings to substrates using a full spread of adhesive applied to substrate to produce a completed installation without open cracks, voids, raising and puckering at joints, telegraphing

of adhesive spreader marks, and other surface imperfections.

### 3.4 TILE INSTALLATION

- A. Layout tiles from center marks established with principal walls, discounting minor offsets, so tiles at opposite edges of room are of equal width. Adjust as necessary to avoid using cut widths that equal less than on-half tile at perimeter.
- B. Match tiles for color and pattern by selecting tiles from cartons in the same sequence as manufactured and packaged, if so numbered. Discard broken, cracked, chipped, or deformed tiles.
  - 1. Open enough cartons of floor tiles to cover each area, and mix tile to ensure shade variations do not occur within any one area.
  - 2. Verify pattern and grain direction with Architect prior to installation.
- C. Hand roll tiles where required by tile manufacturer.

### 3.5 CLEANING AND PROTECTION

- A. Comply with manufacturer's written instructions for cleaning and protection of floor covering.
- B. Perform the following operations immediately after completing resilient product installation:
  - 1. Remove adhesive and other blemishes from exposed surfaces using cleaner recommended by resilient products manufacturers.
  - 2. Sweep and vacuum surfaces thoroughly.
  - 3. Damp-mop surfaces to remove marks and soil.
    - a. Do not wash surfaces until after time period recommended by manufacturer.
- C. Protect resilient products from mars, marks, indentations, and other damage from construction operations and placement of equipment and fixtures during remainder of construction period. Use protection methods recommended in writing by manufacturer.

END OF SECTION 096570



## SECTION 096813 - TILE CARPETING

### PART 1 - GENERAL

#### 1.1 SUMMARY

- A. Section includes modular, fusion-bonded carpet tile.

#### 1.2 PREINSTALLATION MEETINGS

- A. Preinstallation Conference: Conduct conference at Project site.

#### 1.3 ACTION SUBMITTALS

- A. Product Data: For each type of product indicated.
- B. Shop Drawings: Show the following:
  - 1. Columns, doorways, enclosing walls or partitions, built-in cabinets, and locations where cutouts are required in carpet tiles.
  - 2. Type of subfloor.
  - 3. Type of installation.
  - 4. Pattern of installation.
  - 5. Pattern type, location, and direction.
  - 6. Pile direction.
- C. Samples: For each exposed product and for each color and texture specified.

#### 1.4 INFORMATIONAL SUBMITTALS

- A. Product test reports.
- B. Sample warranty.

#### 1.5 CLOSEOUT SUBMITTALS

- A. Maintenance data.

#### 1.6 MAINTENANCE MATERIAL SUBMITTALS

- A. Furnish extra materials, from the same product run, that match products installed and that are packaged with protective covering for storage and identified with labels describing contents.

1. Carpet Tile: Full-size units equal to 5 percent of amount installed for each type indicated, but not less than 10 sq. yd..

#### 1.7 QUALITY ASSURANCE

- A. Installer Qualifications: An experienced installer who is certified by the International Certified Floorcovering Installers Association at the Commercial II certification level.
- B. Fire-Test-Response Ratings: Where indicated, provide carpet tile identical to those of assemblies tested for fire response according to NFPA 253 by a qualified testing agency.

#### 1.8 DELIVERY, STORAGE, AND HANDLING

- A. Comply with CRI 104.

#### 1.9 FIELD CONDITIONS

- A. Comply with CRI 104 for temperature, humidity, and ventilation limitations.

#### 1.10 WARRANTY

- A. Special Warranty for Carpet Tiles: Manufacturer agrees to repair or replace components of carpet tile installation that fail in materials or workmanship within specified warranty period.
  1. Warranty does not include deterioration or failure of carpet tile due to unusual traffic, failure of substrate, vandalism, or abuse.
  2. Failures include, but are not limited to, more than 10 percent edge raveling, snags, runs, dimensional stability, excess static discharge, loss of tuft bind strength, loss of face fiber, and delamination.
  3. Warranty Period: 10 years from date of Substantial Completion.

### PART 2 - PRODUCTS

#### 2.1 CARPET TILE, CPT-1

- A. Products: Subject to compliance with requirements, provide the following:
  1. Shaw Contract #5T099 KIT TILE.
- B. Color: #99111 NATURAL SILK.
- C. Install Pattern: Monolithic.

2.2 CARPET TILE, CPT-2

- A. Products: Subject to compliance with requirements, provide the following:
  - 1. Shaw Contract #5T098 PLAIN WEAVE TILE.
- B. Color: #99111 NATURAL SILK.
- C. Install Pattern: Monolithic.

2.3 CARPET TILE, CPT-3

- A. Products: Subject to compliance with requirements, provide the following:
  - 1. Shaw Contract #5T096 CLOTH TILE.
- B. Color: #99111 NATURAL SILK.
- C. Install Pattern: Monolithic.

2.4 INSTALLATION ACCESSORIES

- A. Trowelable Leveling and Patching Compounds: Latex-modified, hydraulic-cement-based formulation provided or recommended by carpet tile manufacturer.
- B. Adhesives: Water-resistant, mildew-resistant, nonstaining, pressure-sensitive type to suit products and subfloor conditions indicated, that complies with flammability requirements for installed carpet tile and is recommended by carpet tile manufacturer for releasable installation.
  - 1. Adhesives shall have a VOC content of 50 g/L or less when calculated according to 40 CFR 59, Subpart D (EPA Method 24).

PART 3 - EXECUTION

3.1 INSTALLATION

- A. Examine substrates, areas, and conditions, with Installer present, for compliance with requirements for maximum moisture content, alkalinity range, installation tolerances, and other conditions affecting carpet tile performance. Examine carpet tile for type, color, pattern, and potential defects.
- B. Concrete Subfloors: Verify that concrete slabs comply with ASTM F 710.
- C. Proceed with installation only after unsatisfactory conditions have been corrected.
- D. Preparation: Comply with CRI 104, Section 6.2, "Site Conditions; Floor Preparation," and

with carpet tile manufacturer's written installation instructions for preparing substrates indicated to receive carpet tile installation.

- E. Installation: Comply with CRI 104, Section 14, "Carpet Modules," and with carpet tile manufacturer's written installation instructions.
- F. Installation Method: As recommended in writing by carpet tile manufacturer.
- G. Maintain dye lot integrity. Do not mix dye lots in same area.
- H. Cut and fit carpet tile to butt tightly to vertical surfaces, permanent fixtures, and built-in furniture including cabinets, pipes, outlets, edgings, thresholds, and nosings. Bind or seal cut edges as recommended by carpet tile manufacturer.
- I. Extend carpet tile into toe spaces, door reveals, closets, open-bottomed obstructions, removable flanges, alcoves, and similar openings.
- J. Maintain reference markers, holes, and openings that are in place or marked for future cutting by repeating on finish flooring as marked on subfloor. Use nonpermanent, nonstaining marking device.
- K. Install pattern parallel to walls and borders.
- L. Perform the following operations immediately after installing carpet tile:
  - 1. Remove excess adhesive, seam sealer, and other surface blemishes using cleaner recommended by carpet tile manufacturer.
  - 2. Remove yarns that protrude from carpet tile surface.
  - 3. Vacuum carpet tile using commercial machine with face-beater element.
- M. Protect installed carpet tile to comply with CRI 104, Section 16, "Protecting Indoor Installations."

END OF SECTION 096813

## SECTION 096816 - SHEET CARPETING

### PART 1 - GENERAL

#### SUMMARY

Section includes tufted broadloom sheet carpet.

#### 1.1 PREINSTALLATION MEETINGS

A. Preinstallation Conference: Conduct conference at Project site:

1. Review delivery, storage, and handling procedures.
2. Review ambient conditions and ventilation procedures.
3. Review subfloor preparation procedures.
4. Follow manufacturer's broadloom sheet carpet installation guidelines and/or Carpet and Rug Institute Installation Standard 2011 where applicable.

#### 1.2 ACTION SUBMITTALS

A. Product Data: For each type of product indicated:

1. Include manufacturer's written data on physical characteristics and durability.
2. Include manufacturer's written specifications and lab documents for any physical testing.
3. Include installation recommendations for each type of substrate as specified in carpet manufacturer's installation guidelines and/or Carpet and Rug Institute Standard 2011, where applicable.
4. Include carpet maintenance recommendations as outlined by manufacturer.
5. Carpet manufacturer shall also submit a plan for recycling the specified carpet at the end of the useful life of the carpet.

B. Shop Drawings: Show the following:

1. Columns, doorways, enclosing walls or partitions, built-in cabinets, and locations where cutouts are required in carpet tiles.
2. Type of subfloor.
3. Carpet type, color, and dye lot.
4. Seam locations, types, and methods.
5. Type of installation.
6. Pattern of installation.
7. Pattern type, location, and direction.
8. Pile direction.
9. Types, colors, and locations of insets and borders.
10. Types, colors, and locations of edge, transition, and other accessory strips.
11. Transition details to other flooring materials.

C. Samples: For each exposed product and for each color and texture specified. Label each sample

with manufacturer's name, material description, color, pattern, and designation indicated on drawings and in schedules:

1. Carpet: 36 inch square sample.
2. Exposed Edge, Transition, and other Accessory Stripping: 12 inch long sample.
3. Carpet Seam: 12 inch sample.

### 1.3 INFORMATIONAL SUBMITTALS

- A. Product test reports.
- B. Sample warranty.
- C. Qualification data: for installer.

### 1.4 CLOSEOUT SUBMITTALS

- A. Maintenance Data: For carpet to include in maintenance manuals. Include the following:
  1. Methods for maintaining carpet, including cleaning and stain-removal products and procedures and manufacturer's recommended maintenance schedule.
  2. Precautions for cleaning materials and methods that could be detrimental to carpet.

### 1.5 MAINTENANCE MATERIAL SUBMITTALS

- A. Furnish extra materials, from the same product run, that match products installed and that are packaged with protective covering for storage and identified with labels describing contents.
  1. Carpet: Full-size units equal to 5 percent of amount installed for each type indicated, but not less than 10 sq. yd..

### 1.6 QUALITY ASSURANCE

- A. Installer Qualifications: An installer with a minimum of 5 years experience of commercial carpet installation experience and who is certified by the International Certified Floorcovering Installers Association at the Commercial II certification level.
- B. Manufacturer Qualifications: Carpet manufacturer shall have no less than 5 years experience of producing recyclable carpet and shall have published product literature clearly indicating compliance with requirements of this section.
- C. Fire-Test-Response Ratings: Where indicated, provide carpet tile identical to those of assemblies tested for fire response according to NFPA 253 by a qualified testing agency.

### 1.7 DELIVERY, STORAGE, AND HANDLING

- A. Comply with carpet manufacturer's installation recommendations and the Carpet and Rug Institute Installation Standard 2011 where applicable.
- B. Deliver carpet in original mill protective covering with mill register numbers and tags attached.

#### 1.8 FIELD CONDITIONS

- A. Comply with carpet manufacturer's installation recommendations and the Carpet and Rug Institute Standard 2011 for temperature, humidity, and ventilation limitations.
- B. Environmental Limitations: Do not deliver or install carpet until spaces are enclosed and weathertight, wet-work in spaces is complete and dry, and ambient temperature and humidity conditions are maintained at levels planned for building occupants during the remainder of the construction period.
- C. HVAC system should be operational and running prior to carpet installation and should remain running after carpet installation.

#### 1.9 WARRANTY

- A. Special Warranty for Carpet: Manufacturer agrees to repair or replace components of carpet installation that fail in materials or workmanship within specified warranty period.
  - 1. Warranty does not include deterioration or failure of carpet due to unusual traffic, failure of substrate, vandalism, or abuse.
  - 2. Failures include, but are not limited to, more than 10 percent edge raveling, snags, runs, dimensional stability, excess static discharge, loss of tuft bind strength, loss of face fiber, and delamination.
  - 3. Warranty Period: 10 years from date of Substantial Completion.

### PART 2 - PRODUCTS

#### 2.1 TUFTED BROADLOOM CARPET

- A. Subject to compliance with requirements, provide the following:
  - 1. Shaw Contract #5A221 FAULT.
- B. Color: CUSTOM COLOR:
  - 1. NSP Number: N2270173.
  - 2. Tryk Number: F304652.
  - 3. Sales Consultant: Andy Merrill, Andy.Merrill@shawinc.com
- C. Construction: Multi-level pattern cut/loop

- D. Fiber: Eco-solution q® nylon
- E. Dye Method: 100% solution dyed.
- F. Pattern Repeat: 6 feet wide by 6 feet long.
- G. Tufted Weight: 40.0.
- H. Gauge: 1/11.
- I. Stitches per Inch: 11.
- J. Finished Pile Thickness: 0.230.
- K. Total Thickness: 0.346.
- L. Average Density: 6261.
- M. Roll Width: 12 foot.
- N. Primary Backing: synthetic.
- O. Secondary Backing: ultraloc®.
- P. Protective Treatments: ssp® shaw soil protection.
- Q. Performance Characteristics:
  - 1. Radiant Panel ASTM E 648: Class I
  - 2. Smoke Density: Less than 450 per ASTM E 662.
  - 3. Electrostatic Propensity: Less than 3.5 kV.

## 2.2 INSTALLATION ACCESSORIES

- A. Trowelable Leveling and Patching Compounds: Latex-modified, hydraulic-cement-based formulation provided or recommended by carpet manufacturer.
- B. Trowelable Adhesives: Water-resistant, mildew-resistant, nonstaining, premium grade type to suit products and subfloor conditions indicated, that complies with flammability requirements for installed broadloom sheet carpet and is recommended by carpet manufacturer for installation.
  - 1. Adhesives shall have a VOC content of 50 g/L or less.
  - 2. Adhesives shall comply with the testing and product requirements of the California Department of Public Health's "Standard Method for the Testing and Evaluation of Volatile Organic Chemical Emissions from Indoor Sources Using Environmental



Chambers."

3. Adhesives shall comply with the testing and product requirements of the carpet and Rug Institute Green Label Plus Program.
4. Tackless Carpet Stripping (Where a Stretch in Installation is Required): Water-resistant plywood, in strips as required to match cushion thickness and that comply with manufacturer's modular carpet installation guidelines and/or Carpet and Rug Institute Installation Standard 2100 where applicable.
5. Seam Adhesive: Hot-melt adhesive tape or similar product recommended by carpet manufacturer for sealing and taping seams and butting cut edges at backing to form secure seams and to prevent pile loss at seams.
6. Metal Edge/Transition Strips: Extruded aluminum with mill finish of profile and width shown, of height required to protect exposed edge of carpet, and of maximum lengths to minimize running joints.

## PART 3 - EXECUTION

### 3.1 EXAMINATION

- A. Examine substrates, areas, and conditions, with Installer present, for compliance with requirements for maximum moisture content, alkalinity range, installation tolerances, and other conditions affecting carpet performance.
- B. Examine carpet for type, color, pattern, and potential defects prior to installation See manufacturer's requirements for substrate conditions and ambient conditions.
- C. Concrete Slabs: Verify that finishes comply with requirements specified in Section 033000 "Cast-in-Place Concrete" and that surfaces are free of cracks, ridges, depressions, scale, and foreign deposits.

### 3.2 PREPARATION

- A. General: Comply with Carpet and Rug Institute Installation Standard 2011 and with carpet manufacturer's written installation instructions for preparing substrates.
- B. Use trowelable leveling and patching compounds containing a cementitious base with a latex additive, according to manufacturer's written instructions, to fill cracks, holes, depressions, and protrusions in substrates. Fill or level cracks, holes and depressions 1/8 inch wide or wider, and protrusions more than 1/32 inch, unless more stringent requirements are required by manufacturer's written instructions.
- C. Concrete Substrates: Remove coatings, including curing compounds, and other substances that are incompatible with adhesives and that contain soap, wax, oil, or silicone, without using solvents. Use mechanical methods recommended in writing by adhesive and carpet manufacturers.

- D. Broom and vacuum clean substrates to be covered immediately before installing carpet.

### 3.3 CARPET INSTALLATIONS

- A. Comply with Carpet and Rug Institute Installation Standard 2011.
- B. Comply with carpet manufacturer's written instructions and Shop Drawings for seam locations and direction of carpet; maintain uniformity of carpet direction and lay of pile. At doorways, center seams under the door in closed position.
- C. Install pattern parallel to walls and borders.
- D. Install borders with mitered corner seams.
- E. Do not bridge building expansion joints with carpet.
- F. Cut and fit carpet to butt tightly to vertical surfaces, permanent fixtures, and built-in furniture including cabinets, pipes, outlets, edgings, thresholds, and nosings. Bind or seal cut edges as recommended by carpet manufacturer.
- G. Extend carpet into toe spaces, door reveals, closets, open-bottomed obstructions, removable flanges, alcoves, and similar openings.
- H. Maintain reference markers, holes, and openings that are in place or marked for future cutting by repeating on carpet as marked on subfloor. Use nonpermanent, nonstaining marking device.

### 3.4 CLEANING AND PROTECTION

- A. Perform the following operations immediately after installing carpet:
  - 1. Remove excess adhesive, seam sealer, and other surface blemishes using cleaner recommended by carpet manufacturer.
  - 2. Remove yarns that protrude from carpet surface.
  - 3. Vacuum carpet using commercial machine with face-beater element.
- B. Protect installed carpet to comply with Carpet and Rug Institute Installation Standard 2011.
- C. Protect carpet against damage from construction operations and placement of equipment and fixtures during the remainder of construction period. Use protection methods recommended in writing by carpet manufacturer and carpet adhesive manufacturer.

END OF SECTION 096816

Issued for Construction

Verrill Dana Interior Renovations  
Portland, Maine  
Project No. 16001

## SECTION 097200 - WALL COVERINGS

### PART 1 - GENERAL

#### 1.1 SUMMARY

A. Section Includes:

1. Vinyl wall covering.

#### 1.2 ACTION SUBMITTALS

A. Product Data: For each type of product.

- B. Samples: For each type of wall covering and for each color, pattern, texture, and finish specified, full width by 36-inch-long in size.

#### 1.3 INFORMATIONAL SUBMITTALS

A. Product test reports.

#### 1.4 CLOSEOUT SUBMITTALS

A. Maintenance data.

### PART 2 - PRODUCTS

#### 2.1 PERFORMANCE REQUIREMENTS

- A. Fire-Test-Response Characteristics: As determined by testing identical wall coverings applied with identical adhesives to substrates according to test method indicated below by a qualified testing agency. Identify products with appropriate markings of applicable testing agency.

1. Surface-Burning Characteristics: Comply with ASTM E 84; testing by a qualified testing agency. Identify products with appropriate markings of applicable testing agency.
  - a. Class "A" Fire Rated
  - b. Flame-Spread Index: 15.
  - c. Smoke-Developed Index: 20.

2.2 VINYL WALL COVERING WC-1

- A. Manufacturer: Colour & Design, 10024 Maumelle Blvd, North Little Rock, AR 72113
- B. Description:
  - 1. 20 oz. Type II Vinyl Wall Covering.
  - 2. Colourways II series, SKU: CD-CRW-236
  - 3. No substitutions
- C. Width: 54 inches.
- D. Backing: Non Woven.
- E. Repeat: Random.
- F. Meeting Type-II CCC-W-408A through D & W-101 requirements for washability, scrubbability, abrasion resististance, and stain resistance.
- G. Meeting California 01350 IAQ test requirements for wall covering.
- H. Warranty: 5 year warranty against manufacturing defects.

2.3 VINYL WALL COVERING WC-2

- A. Manufacturer: DeNovo, 10024 Maumelle Blvd, North Little Rock, AR 72113
- B. Description:
  - 1. 20 oz. Type II Vinyl Wall Covering.
  - 2. Venue Edition III series. SKU: DN-VS3-30
  - 3. No substitutions
- C. Width: 54 inches.
- D. Backing: Osnaburg.
- E. Repeat: Random.
- F. Meeting Type-II CCC-W-408A through D & W-101 requirements for washability, scrubability, abrasion resististance, and stain resistance.
- G. Meeting California 01350 IAQ test requirements for wall covering.
- H. Warranty: 5 year warranty against manufacturing defects.

## 2.4 VINYL WALL COVERING WC-3

- A. Manufacturer: DeNovo, 10024 Maumelle Blvd, North Little Rock, AR 72113
- B. Description:
  - 1. 20 oz. Type II Vinyl Wall Covering.
  - 2. Venue Edition III series. SKU: DN-VS3-22
  - 3. No substitutions
- C. Width: 54 inches.
- D. Backing: Osnaburg.
- E. Repeat: Random.
- F. Meeting Type-II CCC-W-408A through D & W-101 requirements for washability, scrubability, abrasion resististance, and stain resistance.
- G. Meeting California 01350 IAQ test requirements for wall covering.
- H. Warranty: 5 year warranty against manufacturing defects.

## 2.5 ACCESSORIES

- A. Adhesive: Mildew-resistant, nonstaining, strippable adhesive, for use with specific wall covering and substrate application indicated and as recommended in writing by wall-covering manufacturer.
- B. Primer/Sealer: Mildew resistant, complying with requirements in Section 099123 "Interior Painting" and recommended in writing by primer/sealer and wall-covering manufacturers for intended substrate.
- C. Metal Primer: Interior ferrous metal primer complying with Section 099123 "Interior Painting" and recommended in writing by primer and wall-covering manufacturers for intended substrate.

## PART 3 - EXECUTION

### 3.1 PREPARATION

- A. Comply with manufacturer's written instructions for surface preparation.
- B. Clean substrates of substances that could impair bond of wall covering, including dirt, oil, grease, mold, mildew, and incompatible primers.
- C. Prepare substrates to achieve a smooth, dry, clean, structurally sound surface free of flaking, unsound coatings, cracks, and defects.

1. Moisture Content: Maximum of 5 percent on new plaster, concrete, and concrete masonry units when tested with an electronic moisture meter.
  2. Metals: If not factory primed, clean and apply primer recommended in writing by primer/sealer manufacturer and wall-covering manufacturer.
  3. Gypsum Board: Prime with primer as recommended in writing by primer/sealer manufacturer and wall-covering manufacturer.
  4. Painted Surfaces: Treat areas susceptible to pigment bleeding.
- D. Check painted surfaces for pigment bleeding. Sand gloss, semigloss, and eggshell finish with fine sandpaper.
- E. Remove hardware and hardware accessories, electrical plates and covers, light fixture trims, and similar items.
- F. Acclimatize wall-covering materials by removing them from packaging in the installation areas not less than 24 hours before installation.

### 3.2 WALL-COVERING INSTALLATION

- A. Comply with wall-covering manufacturers' written installation instructions applicable to products and applications indicated.
- B. Cut wall-covering strips in roll number sequence. Change the roll numbers at partition breaks and corners.
- C. Install strips in same order as cut from roll.
- D. Install wall covering without lifted or curling edges and without visible shrinkage.
- E. Match pattern 72 inches above the finish floor.
- F. Install seams vertical and plumb at least 6 inches from outside corners and 3 inches from inside corners unless a change of pattern or color exists at corner. Horizontal seams are not permitted.
- G. Trim edges and seams for color uniformity, pattern match, and tight closure. Butt seams without overlaps or gaps between strips.
- H. Fully bond wall covering to substrate. Remove air bubbles, wrinkles, blisters, and other defects.
- I. Remove excess adhesive at seams, perimeter edges, and adjacent surfaces.
- J. Reinstall hardware and hardware accessories, electrical plates and covers, light fixture trims, and similar items.

END OF SECTION 097200

## SECTION 099123 - INTERIOR PAINTING

### PART 1 - GENERAL

#### 1.1 SUMMARY

- A. Section includes surface preparation and the application of paint systems on the following interior substrates:
  - 1. Steel.
  - 2. Wood.
  - 3. Gypsum board.

#### 1.2 DEFINITIONS

- A. Gloss Level 1: Not more than 5 units at 60 degrees and 10 units at 85 degrees, according to ASTM D 523.
- B. Gloss Level 2: Not more than 10 units at 60 degrees and 10 to 35 units at 85 degrees, according to ASTM D 523.

#### 1.3 ACTION SUBMITTALS

- A. Product Data: For each type of product. Include preparation requirements and application instructions.
- B. Samples: For each type of paint system and in each color and gloss of topcoat.
- C. Product List: For each product indicated. Include printout of current "MPI Approved Products List" for each product category specified in Part 2, with the proposed product highlighted.

#### 1.4 MAINTENANCE MATERIAL SUBMITTALS

- A. Furnish extra materials, from the same product run, that match products installed and that are packaged with protective covering for storage and identified with labels describing contents.
  - 1. Paint: 5 percent, but not less than 1 gal. of each material and color applied.

#### 1.5 QUALITY ASSURANCE

- A. Mockups: Apply mockups of each paint system indicated and each color and finish selected to verify preliminary selections made under Sample submittals and to demonstrate aesthetic effects



and set quality standards for materials and execution.

1. Architect will select one surface to represent surfaces and conditions for application of each paint system specified in Part 3.
  - a. Vertical and Horizontal Surfaces: Provide samples of at least 100 sq. ft (9 sq. m).
  - b. Other Items: Architect will designate items or areas required.
2. Final approval of color selections will be based on mockups.
  - a. If preliminary color selections are not approved, apply additional mockups of additional colors selected by Architect at no added cost to Owner.

## PART 2 - PRODUCTS

### 2.1 MANUFACTURERS

- A. Products: Subject to compliance with requirements, provide one of the products listed in other Part 2 articles for the paint category indicated.

1. Benjamin Moore
2. Or approved equal.

### 2.2 PAINT, GENERAL

- A. Material Compatibility:

1. Provide materials for use within each paint system that are compatible with one another and substrates indicated, under conditions of service and application as demonstrated by manufacturer, based on testing and field experience.
2. For each coat in a paint system, provide products recommended in writing by manufacturers of topcoat for use in paint system and on substrate indicated.

- B. VOC Content: Interior paint products shall be Zero-VOC and Zero Emissions.

- C. Basis of Design: Benjamin Moore "Natura" waterborne acrylic latex interior paint.

- D. Colors: As selected by Architect from manufacturer's full range.

### 2.3 PRIMERS/SEALERS

- A. Primer Sealer, Latex, Interior: MPI #50.
- B. Primer, Latex, for Interior Wood: MPI #50.

## 2.4 METAL PRIMERS

- A. Primer, Alkyd, Anti-Corrosive, for Metal: MPI #107.

## 2.5 WATER-BASED PAINTS

- A. Latex, Interior.

# PART 3 - EXECUTION

## 3.1 EXAMINATION

- A. Examine substrates and conditions, with Applicator present, for compliance with requirements for maximum moisture content and other conditions affecting performance of the Work.
- B. Maximum Moisture Content of Substrates: When measured with an electronic moisture meter as follows:
  - 1. Wood: 15 percent.
  - 2. Gypsum Board: 12 percent.
- C. Verify suitability of substrates, including surface conditions and compatibility with existing finishes and primers.
- D. Proceed with coating application only after unsatisfactory conditions have been corrected.
  - 1. Application of coating indicates acceptance of surfaces and conditions.

## 3.2 PREPARATION

- A. Comply with manufacturer's written instructions and recommendations in "MPI Manual" applicable to substrates indicated.
- B. Remove hardware, covers, plates, and similar items already in place that are removable and are not to be painted. If removal is impractical or impossible because of size or weight of item, provide surface-applied protection before surface preparation and painting.
  - 1. After completing painting operations, use workers skilled in the trades involved to reinstall items that were removed. Remove surface-applied protection if any.
- C. Clean substrates of substances that could impair bond of paints, including dust, dirt, oil, grease, and incompatible paints and encapsulants.
  - 1. Remove incompatible primers and reprime substrate with compatible primers or apply tie coat as required to produce paint systems indicated.

### 3.3 APPLICATION

- A. Apply paints according to manufacturer's written instructions and to recommendations in "MPI Manual."
- B. Apply paints to produce surface films without cloudiness, spotting, holidays, laps, brush marks, roller tracking, runs, sags, ropiness, or other surface imperfections. Cut in sharp lines and color breaks.

### 3.4 CLEANING AND PROTECTION

- A. Protect work of other trades against damage from paint application. Correct damage to work of other trades by cleaning, repairing, replacing, and refinishing, as approved by Architect, and leave in an undamaged condition.
- B. At completion of construction activities of other trades, touch up and restore damaged or defaced painted surfaces.

### 3.5 INTERIOR PAINTING SCHEDULE

- A. Steel Substrates:
  - 1. Latex over Alkyd Primer System:
    - a. Prime Coat: Primer, alkyd, anti-corrosive, for metal, MPI #107.
    - b. Intermediate Coat: Latex, interior, matching topcoat.
    - c. Topcoat: Latex, interior, semi-gloss, (Gloss Level 5), MPI #54 X-Green.
- B. Wood Substrates: Including wood trim.
  - 1. Latex System:
    - a. Prime Coat: Primer, latex, for interior wood, MPI #50.
    - b. Intermediate Coat: Latex, interior, matching topcoat.
    - c. Topcoat: Latex, semi-gloss, (Gloss Level 5), MPI #54 X-Green.
- C. Gypsum Board Substrates:
  - 1. Latex System:
    - a. Prime Coat: Primer sealer, latex, interior, MPI #50.
    - b. Intermediate Coat: Latex, interior, matching topcoat.
    - c. Topcoat: Latex, interior, eggshell, (Gloss Level 3), MPI #52 X-Green.

### 3.6 INTERIOR PAINTING COLOR SCHEDULE (based on Sherwin Williams color chart):

- A. P-1: SW 7042 SOJI WHITE
- B. P-2: SW 6072 VERATILE GRAY
- C. P-3: SW 6247 KRYPTON

Issued for Construction

Verrill Dana Interior Renovations  
Portland, Maine  
Project No. 16001

- D. P-4: SW 7028 INCREDIBLE WHITE
- E. P-5: SW 6327 BOLD BRICK
- F. P-6: SW 7000 IBIS WHITE
- G. P-7: SW 7000 IBIS WHITE (FLAT FINISH)
- H. P-8: SW 9085 TOUCH OF SAND
- I. P-9: SW 7634 PEDIMENT
- J. P-10: SW 7006 EXTRA WHITE

END OF SECTION 099123

Issued for Construction

Verrill Dana Interior Renovations  
Portland, Maine  
Project No. 16001

## SECTION 099300 - STAINING AND TRANSPARENT FINISHING

### PART 1 - GENERAL

#### 1.1 SUMMARY

- A. Section includes surface preparation and application of wood finishes on the following substrates:
  - 1. Interior Substrates:
    - a. Dressed lumber (finish carpentry), including wood trim.
    - b. Wood folding storefront doors.

#### 1.2 DEFINITIONS

- A. Gloss Level 6: 70 to 85 units at 60 degrees, according to ASTM D 523.
- B. Gloss Level 7: More than 85 units at 60 degrees, according to ASTM D 523.

#### 1.3 ACTION SUBMITTALS

- A. Product Data: For each type of product indicated. Include preparation requirements and application instructions.
- B. Samples: For each type of finish system and in each color and gloss of finish indicated.
- C. Product List: For each product indicated, include printout of current "MPI Approved Products List" for each product category specified in Part 2, with the product proposed for use highlighted.

#### 1.4 MAINTENANCE MATERIAL SUBMITTALS

- A. Furnish extra materials, from the same product run, that match products installed and that are packaged with protective covering for storage and identified with labels describing contents.
  - 1. Stains and Transparent Finishes: 5 percent, but not less than 1 gal. of each material and color applied.

#### 1.5 QUALITY ASSURANCE

- A. Mockups: Apply mockups of each finish system indicated and each color selected to verify preliminary selections made under sample submittals and to demonstrate aesthetic effects and set quality standards for materials and execution.

1. Architect will select one surface to represent surfaces and conditions for application of each type of finish system and substrate.
  - a. Vertical and Horizontal Surfaces: Provide samples of at least 100 sq. ft (9 sq. m).
  - b. Other Items: Architect will designate items or areas required.
2. Final approval of stain color selections will be based on mockups.
  - a. If preliminary stain color selections are not approved, apply additional mockups of additional stain colors selected by Architect at no added cost to Owner.

## PART 2 - PRODUCTS

### 2.1 MATERIALS, GENERAL

- A. MPI Standards: Provide products that comply with MPI standards indicated and that are listed in its "MPI Approved Products List."
- B. Material Compatibility:
  1. Provide materials for use within each finish system that are compatible with one another and substrates indicated, under conditions of service and application as demonstrated by manufacturer, based on testing and field experience.
  2. For each coat in a finish system, provide products recommended in writing by manufacturers of topcoat for use in finish system and on substrate indicated.

### 2.2 WATERBORNE ALKYD VARNISH

- A. Semi-gloss interior waterborne alkyd varnish (Basis of Design: Cloverdale "Timberlox 59324): MPI 129.
  1. A general purpose interior varnish featuring good hardness, adhesion, and durability.
  2. Non-flammable and resistant to hot and cold water, household chemicals, and alcohol.
  3. Environmentally friendly with very low odor level.
  4. Soap and water cleanup.
  5. Meeting MPI green performance standard GPS-2-12 (VOC level less than 50 grams per liter).
- B. Color to match existing, as approved by Architect from mock-ups.

## PART 3 - EXECUTION

### 3.1 EXAMINATION

- A. Examine substrates and conditions, with Applicator present, for compliance with requirements

for maximum moisture content and other conditions affecting performance of the Work.

- B. Maximum Moisture Content of Exterior Wood Substrates: 15 percent, when measured with an electronic moisture meter.
- C. Maximum Moisture Content of Interior Wood Substrates: 15 percent, when measured with an electronic moisture meter.
- D. Verify suitability of substrates, including surface conditions and compatibility with existing finishes and primers.
- E. Proceed with finish application only after unsatisfactory conditions have been corrected.
  - 1. Beginning finish application constitutes Contractor's acceptance of substrates and conditions.

### 3.2 PREPARATION

- A. Comply with manufacturer's written instructions and recommendations in "MPI Architectural Painting Specification Manual" applicable to substrates indicated.
- B. Remove hardware, covers, plates, and similar items already in place that are removable. If removal is impractical or impossible because of size or weight of item, provide surface-applied protection before surface preparation and finishing.
  - 1. After completing finishing operations, use workers skilled in the trades involved to reinstall items that were removed. Remove surface-applied protection if any.
- C. Clean and prepare surfaces to be finished according to manufacturer's written instructions for each particular substrate condition and as specified.
  - 1. Remove dust, dirt, oil, and grease by washing with a detergent solution; rinse thoroughly with clean water and allow to dry. Remove grade stamps and pencil marks by sanding lightly. Remove loose wood fibers by brushing.
  - 2. Remove mildew by scrubbing with a commercial wash formulated for mildew removal and as recommended by stain manufacturer.

### 3.3 APPLICATION

- A. Apply finishes according to manufacturer's written instructions and recommendations in "MPI Manual."
- B. Apply finishes to produce surface films without cloudiness, holidays, lap marks, brush marks, runs, ropiness, or other surface imperfections.



3.4 CLEANING AND PROTECTION

- A. Protect work of other trades against damage from finish application. Correct damage by cleaning, repairing, replacing, and refinishing, as approved by Architect, and leave in an undamaged condition.
- B. At completion of construction activities of other trades, touch up and restore damaged or defaced finished wood surfaces.

END OF SECTION 099300

## SECTION 102113 – TOILET COMPARTMENTS

### PART 1 - GENERAL

#### 1.1 SUMMARY

##### A. Section Includes:

1. Solid Phenolic:
  - a. Floor mounted overhead braced toilet compartments.
  - b. Wall mounted urinal privacy screens.

#### 1.2 ACTION SUBMITTALS

##### A. Product Data: for each product specified.

1. Preparation instructions and recommendations.
2. Storage and handling requirements and recommendations.
3. Installation methods.

##### B. Shop Drawings: for each product specified, including the following:

1. Plans, elevations, details of construction and attachment to adjacent construction.
2. Show anchorage locations and accessory items.
3. Verify dimensions with field measurements prior to final production of toilet partitions.

##### C. Selection Samples: For each finish product specified, two complete sets of color chips representing manufacturer's full range of available colors and patterns,

##### D. Verification Samples: For each product specified, two samples, minimum size 6 inches square representing actual product, color, and patterns.

#### 1.3 INFORMATIONAL SUBMITTALS

##### A. Warranty: Sample of manufacturer's standard warranty.

#### 1.4 CLOSEOUT SUBMITTALS

##### A. Maintenance data.

#### 1.5 QUALITY ASSURANCE

- A. Single Source Requirements: To the greatest extent possible provide products from a single manufacturer.
- B. Installer Qualifications: Minimum 2 year experience installing similar products.
- C. Preinstallation Conference: Conduct conference at Project site.

#### 1.6 DELIVERY, STORAGE, AND HANDLING

- A. Deliver and store products in manufacturer's unopened packaging bearing the brand name and manufacturer's identification until ready for installation.
- B. Handling: Handle materials to avoid damage.

#### 1.7 PROJECT CONDITIONS

- A. Maintain environmental conditions (temperature, humidity, and ventilation) within limits recommended by manufacturer for optimum results. Do not install products under environmental conditions outside manufacturer's recommended limits.
- B. Sequencing: Ensure that products of this section are supplied to affected trades in time to prevent interruption of construction progress.

### PART 2 - PRODUCTS

#### 2.1 MANUFACTURERS

- A. Manufacturers: Subject to compliance with requirements, provide products by one of the following:
  - 1. Global Partitions Corp, Eastanollee, Georgia, 30538.
- B. Basis of Design:
  - 1. Alpaco Classic:
    - a. Flush finish self-closing doors.
    - b. Zero-sightline doors and pilasters.
    - c. Adjustable floor pedestals.
    - d. Occupancy Indicator.
    - e. "Ultimate Privacy" 72 inch door panels.
- C. Substitutions:
  - 1. Based on the quality and performance requirements of the project, specifications are based solely on the products of Global Partitions Corp. The Architect will consider products of

comparable manufacturers as a substitution, pending the Contractor's submission of adequate documentation of the substitution in accordance with procedures in Division 1 of the Project Manual. Documentation shall include a list of five similar projects of equivalent size where products have been installed for a minimum of two years, and manufacturer's certification that products are fabricated in the United States. Requests for substitutions will be considered in accordance with provisions of Section 01600.

## 2.2 MATERIALS

### A. Solid Phenolic Toilet Compartments

1. Doors shall be constructed of  $\frac{3}{4}$ " solid phenolic with multiple resin-impregnated kraft sheets fused at high temperature and pressure. Phenolic core color shall be the same as the surface sheets.
2. Panels shall be constructed of  $\frac{1}{2}$ " solid phenolic with multiple resin-impregnated kraft sheets fused at high temperature and pressure. Phenolic core color shall be the same as the surface sheets.
3. Pilasters shall be constructed of  $\frac{3}{4}$ " solid phenolic with multiple resin-impregnated kraft sheets fused at high temperature and pressure. Phenolic core color shall be the same as the surface sheets.

### B. Solid Phenolic Urinal Privacy Screens

1. Wall Mounted:
  - a. Screen height: 58 inches with 6 inches floor clearance.

### C. Color: Wilsonart RIO 7947K-18 Linearity Finish.

### D. Fire Resistance

2. NFPA/IBC Interior Wall and Ceiling Finish: Class B.
  - a. Flame Spread Index (ASTM E 84) 30 for panels and stiles.
  - b. Smoke Developed Index (ASTM E84): 55 for panels, 20 for stiles.

## 2.3 TOILET COMPARTMENT HARDWARE

- A. Continuous stainless steel hinge. Slide latch, strike/keeper and hinges are through bolted onto doors and pilasters using stainless steel vandal-resistant through bolts..
- B. Continuous heavy duty stainless steel wall brackets., mounted with stainless steel, vandal resistant screws.

- C. Pilaster shoes of type 304 steel #4 finish.
- D. Headrail made of heavy-duty anodized extruded aluminum. Headrail is anti-grip and attaches to the top of the pilaster with stainless steel, tamper-resistant screws. Headrail is attached to the adjacent wall constructions with a headrail bracket.
- E. Headrail brackets made from a die cast aluminum alloy and attached to the adjacent wall construction with 2 ½" stainless steel, tamper-resistant screws.
- F. Bumper and coat hook (Provide one on each partition door): Zamac 1" x 3" x 1" Bright finish with theft resistant fasteners.

## PART 3 - EXECUTION

### 3.1 PREPARATION

- A. Prepare substrates including but not limited to blocking and supports in walls and ceilings at points of attachment using methods recommended by the manufacturer for achieving the best result for the substrates under the project conditions.
  - 1. Inspect areas scheduled to receive compartments for correct dimensions, plumbness of walls, and soundness of surfaces that would affect installation of mounting brackets.
  - 2. Verify spacing of plumbing fixtures to assure compatibility with installation of partitions.
- B. Do not proceed with installation until substrates have been properly prepared with blocking and supports in walls and ceilings at points of attachment and deviations from manufacturer's recommended tolerances are corrected. Commencement of installation constitutes acceptance of conditions.

### 3.2 INSTALLATION

- A. Install products in strict compliance with manufacturer's written instructions and recommendations, including the following:
  - 1. Verify blocking and supports in walls and ceilings has been installed properly at points of attachment.
  - 2. Verify location does not interfere with door swings or use of fixtures.
  - 3. Use fasteners and anchors suitable for substrate and project conditions.
  - 4. Install units rigid, straight, plumb, and level.
  - 5. Conceal evidence of drilling, cutting, and fitting to room finish.
  - 6. Test for proper operation.

### 3.3 ADJUSTING, CLEANING, AND PROTECTION

- A. Adjust hardware for proper operation after installation.
- B. Touch-up, repair or replace damaged products.
- C. Clean exposed surfaces of compartments, hardware, and fittings.

END OF SECTION 102113

Issued for Construction

Verrill Dana Interior Renovations  
Portland, Maine  
Project No. 16001

## SECTION 102800 - TOILET, BATH, AND LAUNDRY ACCESSORIES

### PART 1 - GENERAL

#### 1.1 SUMMARY

- A. Section Includes:
  - 1. Public-use washroom accessories.
  - 2. Underlavatory guards.

#### 1.2 ACTION SUBMITTALS

- A. Product Data: For each type of product indicated.
- B. Product Schedule: Indicating types, quantities, sizes, and installation locations by room of each accessory required.
  - 1. Identify locations using room designations indicated.

#### 1.3 INFORMATIONAL SUBMITTALS

- A. Warranty: Sample of special warranty.

#### 1.4 CLOSEOUT SUBMITTALS

- A. Maintenance data.

#### 1.5 WARRANTY

- A. Special Mirror Warranty: Manufacturer's standard form in which manufacturer agrees to replace mirrors that develop visible silver spoilage defects and that fail in materials or workmanship within specified warranty period.
  - 1. Warranty Period: 15 years from date of Substantial Completion.



## PART 2 - PRODUCTS

## 2.1 PUBLIC-USE WASHROOM ACCESSORIES

- A. Manufacturers: Subject to compliance with requirements, provide products by one of the following:
1. A & J Washroom Accessories, Inc.
  2. American Specialties, Inc.
  3. Bobrick Washroom Equipment, Inc.
  4. Bradley Corporation.
  5. GAMCO Specialty Accessories; a division of Bobrick Washroom Equipment, Inc.
  6. Tubular Specialties Manufacturing, Inc.
- B. Surface Mount Toilet Tissue (Roll) Dispenser:
1. Basis-of-Design Product: Bobrick Washroom Equipment, Inc; Contura-S Model B-4288.
  2. Description: Surface Mounted Multi-roll dispenser (for application at toilet partitions).
  3. Unit Front:: 22 gage, drawn, one-piece seamless construction equipped with a flush tumbler lock.
  4. Dispensing: Roll held in reserve automatically drops into place after bottom roll is depleted.
  5. Capacity: Accommodates two standard core 5 ¼" diameter toilet tissue rolls.
  6. Material and Finish: Type 304 Stainless steel, No. 4 finish (satin).
- C. Recessed Toilet Tissue (Roll) Dispenser:
1. Basis-of-Design Product: Bobrick Washroom Equipment, Inc; Contura-S Model B-4388.
  2. Description: Recessed Multi-roll dispenser (for application at drywall partitions).
  3. Unit Front:: 22 gage, drawn, one-piece seamless construction equipped with a flush tumbler lock.
  4. Dispensing: Roll held in reserve automatically drops into place after bottom roll is depleted.
  5. Capacity: Accommodates two standard core 5 ¼" diameter toilet tissue rolls.
  6. Material and Finish: Type 304 Stainless steel, No. 4 finish (satin).
- D. Combination Automatic Universal Roll Paper Towel Dispenser/Waste Receptacle:
1. Basis-of-Design Product: Bobrick Washroom Equipment, Inc.; B-3974.
  2. Description: Recessed automatic universal roll dispenser with electronic sensor that automatically dispenses towel when hands are placed under the towel opening. LED light directs patron to dispense area.
  3. Paper Roll: universal 1 ½ inch to 2" diameter core, up to 8 inch diameter, 8 inch wide non-perforated non-proprietary rolls.
  4. Towel Length: adjustable to 9", 12" of 15", with "paper saver" feature to control second sheet dispense.
  5. Accessories: Bobrick 3974-57 AC adapter kit.
  6. Material and Finish: Stainless steel, No. 4 finish (satin).

7. Lockset: Tumbler type.
8. Waste Capacity: 12 gallons.

E. Foam-Soap Dispenser:

1. Basis-of-Design Product: Bobrick Washroom Equipment, Inc.; B-828.
2. Description: Counter-mounted automatic top-fill bunk foam soap dispenser.
3. Features: Mixture of soap and air-foam quality is field adjustable.
4. Operation: When hand is placed under spout for approximately one second spout will dispense field-adjustable amount of soap.
5. Mounting: Installs in countertops up to 2 inches maximum thickness.
6. Capacity: 34 oz. Dispenser is top-filled through built-in internal funnel after unlocking lid mechanism with special key provided.
7. Spout and Cover Assembly: Bright polished, chrome plated ABS plastic.
8. Single 6V AC adapter #3974-57.

F. Grab Bar:

1. Basis-of-Design Product: Bobrick Washroom Equipment, Inc.; B-6806 Series.
2. Mounting: Flanges with concealed fasteners.
3. Material: Stainless steel, 0.05 inch thick.
  - a. Finish: Smooth, No. 4 finish (satin) on ends and slip-resistant texture in grip area.
4. Outside Diameter: 1-1/2 inches.
5. Configuration and Length: Straight, 36 inches long.

G. Mirror Unit:

1. Frameless 1/4" thick tempered glass, triple silvered, electro-copper plated with baked enamel finish.
2. Hangers: standard clip hangers as provided by mirror manufacturer.
3. Size: As indicated on Drawings.

## 2.2 UNDERLAVATORY GUARDS

A. Manufacturers: Subject to compliance with requirements, provide products by one of the following:

1. Plumberex Specialty Products, Inc.
2. Truebro by IPS Corporation.

B. Underlavatory Guard:

1. Description: Insulating pipe covering for supply and drain piping assemblies that prevent direct contact with and burns from piping; allow service access without removing coverings.
2. Material and Finish: Antimicrobial, molded plastic, white.

## 2.3 CUSTODIAL ACCESSORIES

- A. Manufacturers: Subject to compliance with requirements, provide products by one of the following:
1. Bobrick Washroom Equipment, Inc.
  2. Bradley Corporation.
- B. Mop and Broom Holder:
1. Basis-of-Design Products: Bobrick Washroom Equipment, Inc.; Model B-239 or Bradley Corporation; Model 9933.
  2. Description: Unit with shelf, hooks, holders, and rod suspended beneath shelf.
  3. Length: 36 inches.
  4. Hooks: Three.
  5. Mop/Broom Holders: Four, spring-loaded, rubber hat, cam type.
  6. Material and Finish: Stainless steel, No. 4 finish (satin).
    - a. Shelf: Not less than nominal 0.05-inch-thick stainless steel.
    - b. Rod: Approximately 1/4-inch-diameter stainless steel.

## 2.4 FABRICATION

- A. Keys: Provide universal keys for internal access to accessories for servicing and resupplying. Provide minimum of six keys to Owner's representative.

## PART 3 - EXECUTION

### 3.1 INSTALLATION

- A. Install accessories according to manufacturers' written instructions, using fasteners appropriate to substrate indicated and recommended by unit manufacturer. Install units level, plumb, and firmly anchored in locations and at heights indicated.
- B. Grab Bars: Install to withstand a downward load of at least 250 lbf, when tested according to ASTM F 446.

END OF SECTION 102800

## SECTION 104413 - FIRE EXTINGUISHER CABINETS

### PART 1 - GENERAL

#### 1.1 SUMMARY

- A. Section includes fire protection cabinets for fire extinguishers.

#### 1.2 ACTION SUBMITTALS

- A. Product Data: For each type of product indicated.
- B. Shop Drawings: For fire protection cabinets. Include plans, elevations, sections, details, and attachments to other work.
- C. Samples: For each exposed product and for each color and texture specified.

#### 1.3 CLOSEOUT SUBMITTALS

- A. Maintenance data.

#### 1.4 QUALITY ASSURANCE

- A. Coordinate size of fire protection cabinets to ensure that type and capacity of fire extinguishers indicated are accommodated.
- B. Coordinate sizes and locations of fire protection cabinets with wall depths.

### PART 2 - PRODUCTS

#### 2.1 MATERIALS

- A. Cold-Rolled Steel Sheet: ASTM A 1008/A 1008M, Commercial Steel (CS), Type B.
- B. Clear Float Glass: ASTM C 1036, Type I, Class 1, Quality q3, 6 mm thick.

#### 2.2 FIRE PROTECTION CABINET

- A. Cabinet Type: Suitable for fire extinguisher.
  - 1. Products: Subject to compliance with requirements, provide one of the following:

- a. J. L. Industries, Inc., a division of Activar Construction Products Group; Ambassador Series.
  - b. Larsen's Manufacturing Company; Architectural Series.
  - c. Potter Roemer LLC; 1770 Series.
  - d. Or approved equal.
- B. Cabinet Construction: Nonrated, one-hour rated, or two-hour rated: to match the rating of the wall assembly into which the cabinet will be installed.
- C. Cabinet Material: Steel sheet.
- D. Recessed Cabinet: Cabinet box recessed in walls of sufficient depth to suit style of trim indicated.
1. Exposed Flat Trim: One-piece combination trim and perimeter door frame overlapping surrounding wall surface with exposed trim face and wall return at outer edge (backbend).
- E. Semirecessed Cabinet: Cabinet box partially recessed in walls of sufficient depth to suit style of trim indicated; with one-piece combination trim and perimeter door frame overlapping surrounding wall surface with exposed trim face and wall return at outer edge (backbend). Provide where walls are of insufficient depth for recessed cabinets but are of sufficient depth to accommodate semirecessed cabinet installation.
1. Square-Edge Trim: 1-1/4- to 1-1/2-inch backbend depth.
- F. Cabinet Trim Material: Steel sheet.
- G. Door Material: Steel sheet.
- H. Door Style: Center glass panel with frame.
- I. Door Glazing: Clear float glass.
- J. Door Hardware: Manufacturer's standard door-operating hardware of proper type for cabinet type, trim style, and door material and style indicated.
- K. Accessories:
1. Mounting Bracket: Manufacturer's standard steel, designed to secure fire extinguisher to fire protection cabinet, of sizes required for types and capacities of fire extinguishers indicated, with plated or baked-enamel finish.
  2. Door Lock: Cam lock that allows door to be opened during emergency by pulling sharply on door handle.
  3. Identification: Lettering complying with authorities having jurisdiction for letter style, size, spacing, and location. Locate as directed by Architect.
    - a. Identify fire extinguisher in fire protection cabinet with the words "FIRE EXTINGUISHER."
      - 1) Location: Applied to cabinet door.
      - 2) Application Process: Decals.

- 3) Lettering Color: Red.
- 4) Orientation: Vertical.

L. Finishes:

1. Manufacturer's standard baked-enamel paint for the following:
  - a. Exterior of cabinet door, and trim, except for those surfaces indicated to receive another finish.
  - b. Interior of cabinet and door.
2. Steel: Baked enamel or powder coat.
  - a. Color and Gloss: As selected by Architect from manufacturer's full range.

2.3 FABRICATION

- A. Fire Protection Cabinets: Provide manufacturer's standard box (tub), with trim, frame, door, and hardware to suit cabinet type, trim style, and door style indicated. Miter and weld joints and grind smooth.

PART 3 - EXECUTION

3.1 INSTALLATION

- A. Examine walls and partitions for suitable framing depth and blocking where semirecessed cabinets will be installed and prepare recesses as required by type and size of cabinet and trim style.
- B. Install fire protection cabinets in locations and at mounting heights indicated or, if not indicated, at heights acceptable to authorities having jurisdiction.
- C. Fire Protection Cabinets: Fasten cabinets to structure, square and plumb.
- D. Identification: Apply decals at locations indicated.
- E. Adjust fire protection cabinet doors to operate easily without binding. Verify that integral locking devices operate properly.
- F. Replace fire protection cabinets that have been damaged or have deteriorated beyond successful repair by finish touchup or similar minor repair procedures.

END OF SECTION 104413

Issued for Construction

Verrill Dana Interior Renovations  
Portland, Maine  
Project No. 16001

## SECTION 122116 - VERTICAL LOUVER BLINDS

### PART 1 - GENERAL

#### 1.1 SUMMARY

- C. Section includes vertical louver blinds with PVC vanes.

#### 1.2 ACTION SUBMITTALS

- C. Product Data: For each type of product.
- D. Shop Drawings: Show fabrication and installation details for vertical louver blinds.
- E. Samples: For each exposed product and for each color and texture specified.

#### 1.3 INFORMATIONAL SUBMITTALS

- C. Product certificates.
- D. Product test reports.

#### 1.4 CLOSEOUT SUBMITTALS

- C. Maintenance data.

#### 1.5 QUALITY ASSURANCE

- C. Mockups: Build mockups to verify selections made under Sample submittals and to demonstrate aesthetic effects and set quality standards for fabrication and installation.

1. Approval of mockups does not constitute approval of deviations from the Contract Documents contained in mockups unless Architect specifically approves such deviations in writing.
2. Subject to compliance with requirements, approved mockups may become part of the completed Work if undisturbed at time of Substantial Completion.



## PART 2 - PRODUCTS

### 2.1 VERTICAL LOUVER BLINDS

- A. Manufacturers: Subject to compliance with requirements, provide products by one of the following:
  - 1. Hunter Douglas Contract.
  - 2. Levolor Contract; a Newell Rubbermaid company.
  - 3. Springs Window Fashions.
- B. PVC Vanes: Lead-free, UV-stabilized; with not less than 3/8-inch overlap when vanes are rotated fully closed.
  - 1. Width: 3 1/2 inches.
  - 2. Profile: Flat.
  - 3. Flame-Resistance Rating: Comply with NFPA 701; testing by a qualified testing agency. Identify products with appropriate markings of applicable testing agency.
  - 4. Features:
    - a. Bottom chain.
- C. Headrail: Encloses operating mechanisms including carrier-spacing mechanism that provides uniform vane spacing when blinds are traversed fully across headrail (closed).
  - 1. Draw and Stack: One way, stack left.
- D. Carriers: Engineered plastic with gears to align and synchronize vane rotation and stems that allow vane removal and replacement. Lead carriers have self-lubricating wheels or elongated bearing surfaces; following carriers have self-lubricating wheels.
- E. Valance: Manufacturer's standard with vane insert.
- F. Mounting Brackets: With spacers and shims required for blind placement and alignment indicated.
  - 1. Type: Wall.
  - 2. Intermediate Support: Provide intermediate support brackets to produce support spacing recommended by blind manufacturer for weight and size of blind.
- G. Colors, Textures, and Patterns:
  - 1. Vanes:
    - a. PVC: As selected by Architect from manufacturer's full range.
  - 2. Components: Provide materials exposed to view matching or coordinating with PVC

vanes unless otherwise indicated.

## 2.2 VERTICAL LOUVER BLIND FABRICATION

- A. Product Safety Standard: Fabricate vertical louver blinds to comply with WCMA A 100.1 including requirements for corded, flexible, looped devices; lead content of components; and warning labels.
- B. Unit Sizes: Fabricate units in sizes to cover window and other openings as follows, measured at 74 deg F:
  - 1. Between (Inside) Jamb Installation: Width equal to jamb-to-jamb dimension of opening in which blind is installed less 1/4 inch per side or 1/2 inch total, plus or minus 1/8 inch. Length equal to head-to-sill or -floor dimension of opening in which blind is installed less 1/4 inch, plus or minus 1/8 inch.

## PART 3 - EXECUTION

### 3.1 INSTALLATION

- A. Examine substrates, areas, and conditions, with Installer present, for compliance with requirements for installation tolerances, operational clearances, and other conditions affecting performance.
  - 1. Proceed with installation only after unsatisfactory conditions have been corrected.
- B. Install vertical louver blinds level and plumb, aligned and centered on openings, and aligned with adjacent units according to manufacturer's written instructions.
  - 1. Locate so exterior vane edges are not closer than 2 inches from interior faces of glass and not closer than 1-1/2 inches from interior faces of glazing frames through full operating ranges of blinds.
  - 2. Install mounting and intermediate brackets to prevent deflection of headrails.
  - 3. Install with clearances that prevent interference with adjacent blinds, adjacent construction, and operating hardware of glazed openings, other window treatments, and similar building components and furnishings.
- C. Adjust vertical louver blinds to operate free of binding or malfunction through full operating ranges.
- D. Clean vertical louver blind surfaces after installation according to manufacturer's written instructions.

END OF SECTION 122116

Issued for Construction

Verrill Dana Interior Renovations  
Portland, Maine  
Project No. 16001

## SECTION 122400 – MOTORIZED WINDOW SHADES

### PART 1 - GENERAL

#### 1.1 SUMMARY

- A. Section includes motorized, roll-up fabric interior window shades including motor operator, controls, and mounting hardware.
  - 1. Roller shades at interior full height window walls where shown on drawings.

#### 1.2 ACTION SUBMITTALS

- A. Product Data: Manufacturer's data sheets on each product specified including:
  - 1. Preparation instructions and recommendations.
  - 2. Installation and maintenance instructions.
  - 3. Styles, material descriptions, dimensions of individual components, profiles, features, finishes, and operating instructions.
  - 4. Storage and handling requirements and recommendations.
  - 5. Mounting details and installation methods.
  - 6. Typical wiring diagrams including integration of motor controllers with building management system, audiovisual and lighting control systems as applicable.
- B. Shop Drawings: Plans, elevations, sections, product details, installation details, operational clearances, wiring diagrams and relationship to adjacent work.\
- C. Window Treatment Schedule: For all roller shades. Use same room designations as indicated on the Drawings, field verified window dimensions, quantities, type of shade, controls, fabric, and color, and include opening sizes and key to typical mounting details.
- D. Samples: For each finish product specified, two complete sets of shade cloth options and aluminum finish color samples representing manufacturer's full range of available colors and patterns.
- E. Maintenance Data: Methods for maintaining roller shades, precautions regarding cleaning materials and methods, instructions for operating hardware and controls.
- F. Manufacturer's Certificates: Certify products meet or exceed specified requirements.

#### 1.3 QUALITY ASSURANCE

- A. Manufacturer Qualifications: Obtain roller shades through one source from a single manufacturer with a minimum of twenty years experience in manufacturing products comparable to those specified in this section.
- B. NFPA Flame-Test: Passes NFPA 701. Materials tested shall be identical to products proposed for

use.

- C. Mockups: Provide a mock-up of one of each type roller shade assembly specified for evaluation of mounting, appearance and accessories.
  - 1. Locate mock-up in window(s) designated by Architect.
  - 2. Do not proceed with remaining work until mock-up is accepted by Architect.

#### 1.4 DELIVERY, STORAGE, AND HANDLING

- A. Do not deliver window shades until building is enclosed and construction within spaces where shades will be installed is nearly complete.
- B. Deliver products in manufacturer's original, unopened, undamaged containers with labels intact.
- C. Label containers and shades according to Window Shade Schedule.
- D. Store products in manufacturer's unopened packaging until ready for installation.

#### 1.5 SEQUENCING

- A. Ensure that locating templates and other information required for installation of products of this section are furnished to affected trades in time to prevent interruption of construction progress.
- B. Ensure that products of this section are supplied to affected trades in time to prevent interruption of construction progress.

#### 1.6 PROJECT CONDITIONS

- A. Install roller shades after finish work and ambient temperature, humidity and ventilation conditions are maintained at levels recommended for project upon completion.

#### 1.7 WARRANTY

- A. Hardware and Shade Fabric: Manufacturer's standard twenty-five year limited warranty.
- B. Motors and Controls: Manufacturer's standard five- year limited warranty.

### PART 2 - PRODUCTS

#### 2.1 MANUFACTURERS

- A. Manufacturers: Draper, Inc., which is located at: 411 S. Pearl P. O. Box 425 ; Spiceland, IN 47385-0425; Toll Free Tel: 800-238-7999.

- B. Substitutions will be considered in accordance with provisions of Section 012500 - Substitution Procedures.

## 2.2 MOTORIZED WINDOW SHADES

- A. Type: Motorized vertical roll-up, fabric, window shade with motors, controls, mounting brackets, and other components necessary for complete installation.
  - 1. Motorized FlexShade as manufactured by Draper, Inc., (Basis of Design).
  - 2. Mounting Type:
    - a. Ceiling Pocket.
- B. Shade Motor and Control System: Standard Motor: 110 VAC, single phase, 60 HZ, instantly reversible, lifetime lubricated, and equipped with internal thermal overload protector, electric brake, and pre-set accessible limit switches. Tubular motor concealed inside each shade roller tube.
  - 1. Individual Control: Wall Switch - Toggle three position wall switch.
- C. Roller: Fabricated from extruded aluminum or steel. Diameter, wall thickness, and material selected by manufacturer to accommodate shade size. Provide with roller idler assembly of molded nylon and zinc-plated steel pin. Sliding pin to allow easy installation and removal of roller. Fabric connected to the roller tube with LSE (low surface energy) double sided adhesive specifically developed to attach coated textiles to metal. Adhesive attachment to eliminate horizontal impressions in fabric.
- D. Type D Shade pocket: Rectangular pocket designed for recessed ceiling installation of window shades.
  - 1. Material: Extruded aluminum alloy with white epoxy paint finish.
  - 2. Size: 5 inches (127 mm) by 5-5/8 inches (137 mm) high.
  - 3. Closure Panel: 3"
- E. Room Darkening Fabric
  - 1. Flocke by Mermet; Opaque, PVC-free fiberglass textile with acrylic backing. 17.1 oz/sq yd, .024 inches thick. Fire rating: NFPA 701, both small- and large-scale tests. Antistatic treated.
  - 2. Color and Pattern: As selected by Architect from manufacturer's standard range.

## PART 3 - EXECUTION

### 3.1 EXAMINATION

- A. Do not begin installation until substrates have been properly prepared.
- B. Proceed with installation only after unsatisfactory conditions have been corrected.

### 3.2 PREPARATION

- A. Coordinate requirements for blocking and structural supports to ensure adequate means for installation of window shades.
- B. Coordinate installation of recessed shade pockets with construction of suspended gypsum board ceilings.
- C. Coordinate requirements for power supply conduit, and wiring required for window shade motors and controls.

### 3.3 INSTALLATION

- A. Install in accordance with manufacturer's instructions.
- B. Install roller shades level, plumb, square, and true. Allow proper clearances for window operation hardware.
- C. Shade Pockets:
  - 1. Install shade pockets prior to installation of ceiling system. Attach to supporting structure with screws through top of pocket at 24 inches (610 mm) minimum centers.
  - 2. After interior construction is essentially complete, install shade and operating mechanism in pocket.
- D. Install the Closure Panels to conceal roller and operating mechanism. Do not use exposed fasteners.

### 3.4 TESTING AND DEMONSTRATION

- A. Test motorized window shades to verify that controls, limit switches, interface to other building systems, and other operating components are functional. Correct deficiencies.
- B. Demonstrate operation of shades to Owner's designated representatives.

### 3.5 PROTECTION

- A. Protect installed products until completion of project.
- B. Touch-up, repair or replace damaged products before Substantial Completion.

END OF SECTION 122400

## SECTION 122413 - ROLLER WINDOW SHADES

### PART 7 - GENERAL

#### 7.1 SUMMARY

- A. Section includes manually operated roller shades.
  - 1. Roller shades at exterior windows.

#### 7.2 ACTION SUBMITTALS

- A. Product Data: For each type of product.
  - 1. Include styles, material descriptions, construction details, dimensions of individual components and profiles, features, finishes, and operating instructions for roller shades.
- B. Shop Drawings: Show fabrication and installation details for roller shades, including shadeband materials, their orientation to rollers, and their seam and batten locations.
- C. Samples: For each exposed product and for each color and texture specified.
- D. Roller-Shade Schedule: Use same designations indicated on Drawings.

#### 7.3 INFORMATIONAL SUBMITTALS

- A. Product certificates.
- B. Product test reports.

#### 7.4 CLOSEOUT SUBMITTALS

- A. Maintenance data.

#### 7.5 QUALITY ASSURANCE

- A. Installer Qualifications: Fabricator of products.
- B. Mockups: Build mockups to verify selections made under Sample submittals, to demonstrate aesthetic effects, and to set quality standards for materials and execution.
  - 1. Approval of mockups does not constitute approval of deviations from the Contract Documents contained in mockups unless Architect specifically approves such deviations in



- writing.
2. Subject to compliance with requirements, approved mockups may become part of the completed Work if undisturbed at time of Substantial Completion.

## PART 8 - PRODUCTS

### 8.1 MANUFACTURERS

- A. Manufacturers: Subject to compliance with requirements, provide products by one of the following:
  1. Draper Inc.
  2. Hunter Douglas Contract.
  3. Lutron Electronics Co., Inc.
  4. MechoShade Systems, Inc.
  5. Shade Techniques, LLC.
  6. Silent Gliss USA, Inc.

### 8.2 ROLLER SHADES

- A. Chain-and-Clutch Operating Mechanisms: With continuous-loop bead chain and clutch that stops shade movement when bead chain is released; permanently adjusted and lubricated.
  1. Bead Chains: Manufacturer's standard.
    - a. Loop Length: Full length of roller shade.
    - b. Limit Stops: Provide upper and lower ball stops.
    - c. Chain-Retainer Type: Clip, jamb mount.
  2. Spring Lift-Assist Mechanisms: Manufacturer's standard for balancing roller-shade weight and lifting heavy roller shades.
    - a. Provide for shadebands that weigh more than 10 lb or for shades as recommended by manufacturer, whichever criteria are more stringent.
- B. Rollers: Corrosion-resistant steel or extruded-aluminum tubes of diameters and wall thicknesses required to accommodate operating mechanisms and weights and widths of shadebands indicated without deflection. Provide with permanently lubricated drive-end assemblies and idle-end assemblies designed to facilitate removal of shadebands for service.
  1. Roller Mounting Configuration: Single roller.
  2. Roller Drive-End Location: Right side of inside face of shade.
  3. Direction of Shadeband Roll: Regular, from back of roller.
  4. Shadeband-to-Roller Attachment: Manufacturer's standard method.
- C. Mounting Hardware: Brackets or endcaps, corrosion resistant and compatible with roller assembly, operating mechanism, installation accessories, and mounting location and conditions indicated.

D. Shadebands:

1. Shadeband Material: Light-filtering fabric.
2. Shadeband Bottom (Hem) Bar: Steel or extruded aluminum.
  - a. Type: Enclosed in sealed pocket of shadeband material .
  - b. Color and Finish: As selected by Architect from manufacturer's full range.

E. Installation Accessories:

1. Front Fascia: Aluminum extrusion that conceals front and underside of roller and operating mechanism and attaches to roller endcaps without exposed fasteners.
  - a. Shape: L-shaped.
  - b. Height: Manufacturer's standard height required to conceal roller and shadeband when shade is fully open, but not less than 4 inches.
2. Installation Accessories Color and Finish: As selected from manufacturer's full range.

### 8.3 SHADEBAND MATERIALS

A. Shadeband Material Flame-Resistance Rating: Comply with NFPA 701. Testing by a qualified testing agency. Identify products with appropriate markings of applicable testing agency.

B. Light-Filtering Fabric: Woven fabric, stain and fade resistant.

1. Source: Roller-shade manufacturer .
2. Type: PVC-coated fiberglass.
3. Weave: Mesh.
4. Weight: 6.0 oz./sq. yd.
5. Roll Width: 36 inches.
6. Orientation on Shadeband: As indicated on Drawings.
7. Openness Factor: As selected by Architect.
8. Color: As indicated on Drawings As selected by Architect from manufacturer's full range.

C. Light-Blocking Fabric: Opaque fabric, stain and fade resistant.

1. Source: Roller-shade manufacturer.
2. Type: Fiberglass textile with PVC film bonded to both sides.
3. Roll Width: 36 inches.
4. Orientation on Shadeband: As indicated on Drawings.
5. Features: Washable.
6. Color: As selected by Architect from manufacturer's full range.

### 8.4 ROLLER-SHADE FABRICATION

A. Product Safety Standard: Fabricate roller shades to comply with WCMA A 100.1, including requirements for flexible, chain-loop devices; lead content of components; and warning labels.

B. Unit Sizes: Fabricate units in sizes to fill window and other openings as follows, measured at 74  
September 21, 2016 122413 - 3 ROLLER WINDOW SHADES

deg F:

1. Between (Inside) Jamb Installation: Width equal to jamb-to-jamb dimension of opening in which shade is installed less 1/4 inch per side or 1/2-inch total, plus or minus 1/8 inch. Length equal to head-to-sill or -floor dimension of opening in which shade is installed less 1/4 inch, plus or minus 1/8 inch.
- C. Shadeband Fabrication: Fabricate shadebands without battens or seams to extent possible except as follows:
1. Vertical Shades: Where width-to-length ratio of shadeband is equal to or greater than 1:4, provide battens and seams at uniform spacings along shadeband length to ensure shadeband tracking and alignment through its full range of movement without distortion of the material.

## PART 9 - EXECUTION

### 9.1 ROLLER-SHADE INSTALLATION

- A. Examine substrates, areas, and conditions, with Installer present, for compliance with requirements for installation tolerances, operational clearances, and other conditions affecting performance of the Work.
- B. Proceed with installation only after unsatisfactory conditions have been corrected.
- C. Install roller shades level, plumb, and aligned with adjacent units, according to manufacturer's written instructions.
- D. Adjust and balance roller shades to operate smoothly, easily, safely, and free from binding or malfunction throughout entire operational range.
- E. Clean roller-shade surfaces after installation, according to manufacturer's written instructions.

END OF SECTION 122413

## SECTION 123661 – SIMULATED STONE COUNTERTOPS

### PART 1 - GENERAL

#### 1.1 SUMMARY

- A. Solid surface countertops and backsplashes.

#### 1.2 ACTION SUBMITTALS

- A. Product Data: For countertop material.
- B. Shop Drawings: For Countertops. Show materials, finishes, edge and backsplash profiles, methods of joining, and cutouts for plumbing fixtures.
- C. Samples: For each type of material exposed to view:
  - 1. 3 inch x 3 inch quartz samples in specified colors.
  - 2. 3 inch long joint sealer samples in specified colors.
- D. Maintenance Data: Include recommended cleaning materials and procedures, and list of materials detrimental to quartz.

#### 1.3 QUALITY ASSURANCE

- A. Manufacturer's Qualifications: Minimum 10 years experience. In manufacture of quartz surfacing materials.
- B. Fabricator and Installer Qualifications: Minimum 2 years experience in work of this Section.
- C. Mock-up:
  - 1. Construct full size mock-up.
  - 2. Include plumbing fixtures and trim.
  - 3. Locate where directed by architect.
  - 4. Approved mock-up may remain as part of the Work.

#### 1.4 WARRANTY

- A. Provide manufacturer's 10 year warranty against defects in materials and workmanship.

### PART 2 - PRODUCTS

2.1 SOLID-SURFACE-MATERIAL COUNTERTOPS, SS-1

- A. Configuration: Provide countertops with the following front and backsplash style:
  - 1. Front: 3/4-inch bullnose.
  - 2. Backsplash: Straight, lightly eased at corner.
  - 3. Endsplash: Straight, lightly eased at corner.
- B. Countertops: 3/4-inch thick, solid surface material with front edge built up with the same material.
- C. Backsplashes and Endsplashes: 3/4-inch thick, solid surface material.
- D. Surface Finish: Polished.

2.2 SOLID-SURFACE-MATERIAL MANUFACTURER

- A. Solid Surface Material: Homogeneous solid sheets of filled plastic resin.
  - 1. Manufacturers: Subject to compliance with requirements, provide products by one of the following:
    - a. Consentino Central; Silestone Quartz.
    - b. Or equal as approved by Architect.
- B. Solid-Surface Material:
  - 1. SS-1 WHITE NORTH
  - 2. SS-2 LUSSO
  - 3. SS-1 NEBUL ALPHA - ARIEL
  - 4. SS-1 GREY AMAZON

2.3 ACCESSORIES

- A. Joint sealer:
  - 1. Latisil Tile and Stone Sealant by Laticrete International, Inc.
  - 2. Color: To be selected from manufacturer's full color range.
- B. Adhesives: Type recommended by manufacturer.

PART 3 - EXECUTION

3.1 FABRICATION

- A. Cut quartz accurately to required shapes and dimensions.

- 1. Fabricate edges to specified profile.
- 2. Fabricate with hairline joints.
- 3. Cut holes for sinks, faucets, accessories

### 3.2 PREPARATION

- A. Clean surfaces to receive fabrications; remove loose and foreign matter that could interfere with adhesion.

### 3.3 INSTALLATION

- A. Install fabrications in accordance with manufacturer's instructions and approved Shop Drawings.
- B. Adhere fabrications with continuous beads of adhesive.
- C. Set plumb and level. Align adjacent pieces in same plane.
- D. Install with hairline joints.
- E. Fill joints between fabrications and adjacent construction with joint sealer; finish smooth and flush.

### 3.4 INSTALLATION TOLERANCES

- A. Maximum variation from level and plumb: 1/8 inch in 10 feet, noncumulative.
- B. Maximum variation in plane between adjacent pieces at joint: Plus or minus 1/16 inch.

### 3.5 CLEANING

- A. Clean fabrications in accordance with manufacturer's instructions.

### 3.6 PROTECTION

- A. Protect installed fabrications with nonstaining sheet coverings.

END OF SECTION 123661

SECTION 220500 – COMMON WORK RESULTS FOR PLUMBING

PART 1 - GENERAL

1.1 RELATED DOCUMENTS

- A. Refer to Section 230500, common work results for plumbing are included in this section.

END OF SECTION 220500





SECTION 220529 - HANGERS AND SUPPORTS FOR PLUMBING PIPING AND EQUIPMENT

PART 1 - GENERAL

1.1 RELATED DOCUMENTS

- A. Refer to Section 230529 for hangers and supports for plumbing piping and equipment.

END OF SECTION 220529



SECTION 220553 – IDENTIFICATION FOR PLUMBING PIPING & EQUIPMENT

PART 1 - GENERAL

1.1 RELATED DOCUMENTS

- A. Refer to Section 230553 for identification for plumbing piping and equipment.

END OF SECTION 220553



SECTION 220700 - PLUMBING INSULATION

PART 1 - GENERAL

1.1 RELATED DOCUMENTS

- A. Refer to Section 230700 for plumbing insulation.

END OF SECTION 220700



## SECTION 221116 - DOMESTIC WATER PIPING

### PART 1 - GENERAL

#### 1.1 RELATED DOCUMENTS

- A. Drawings and general provisions of the Contract, including General and Supplementary Conditions and Division 1 Specification Sections, apply to this Section.
- B. Related Sections include the following:
  - 1. Division 22 Section "Common Work Results for Plumbing"
  - 2. Division 22 Section "Hangers and Supports"
  - 3. Division 22 Section "Plumbing Specialties" for water distribution piping specialties.

#### 1.2 SUMMARY

- A. This Section includes domestic water piping from locations indicated to fixtures and equipment inside the building.
- B. Drawings show the general layout of piping and accessories but do not show all required fittings and offsets that may be necessary to connect piping to equipment and to coordinate with other trades. Fabricate piping based on field measurements. Provide all necessary fittings and offsets.
- C. General layout shown, provide piping to fixtures as required by the Maine Plumbing Code. A licensed master plumber shall perform or supervise the work and provide layouts, piping, and fittings as required by code.

#### 1.3 SUBMITTALS

- A. Product Data: For the following products:
  - 1. Specialty valves.
  - 2. Transition fittings.
  - 3. Dielectric fittings.
  - 4. Escutcheons.
- B. Field quality-control reports.

#### 1.4 QUALITY ASSURANCE

- A. Piping materials shall bear label, stamp, or other markings of specified testing agency.
- B. Comply with the UPC 2009 edition, subject to the exclusions and amendments set forth by the Maine Plumbers Examining Board.

- C. Qualify brazing processes for copper and copper alloy pipe and tube according to ANSI/AWS C3.4.
- D. Comply with NFPA 24, "Installation of Private Fire Service Mains and Their Appurtenances," and NSF 61, "Drinking Water System Components-Health Effects; Sections 1 through 9," for combined fire-protection and domestic water service piping to building.
- E. Comply with NSF 61, "Drinking Water System Components-Health Effects; Sections 1 through 9," for potable domestic water piping and components.
- F. Water line components shall be lead-free.

## PART 2 - PRODUCTS

### 2.1 PIPING MATERIALS

- A. Refer to Part 3 "Piping Applications" Article for applications of pipe, tube, fitting, and joining materials.
- B. Transition Couplings for Aboveground Pressure Piping: Coupling or other manufactured fitting the same size as, with pressure rating at least equal to and ends compatible with, piping to be joined.

### 2.2 COPPER TUBING

- A. Soft Copper Tube: ASTM B 88, Types K and L, water tube, annealed temper.
  - 1. Copper Pressure Fittings: ASME B16.18, cast-copper-alloy or ASME B16.22, wrought-copper, solder-joint fittings. Furnish wrought-copper fittings if indicated.
  - 2. Bronze Flanges: ASME B16.24, Class 150, with solder-joint end. Furnish Class 300 flanges if required to match piping.
  - 3. Copper Unions: MSS SP-123, cast-copper-alloy, hexagonal-stock body, with ball-and-socket, metal-to-metal seating surfaces and solder-joint or threaded ends.
- B. Hard Copper Tube: ASTM B 88, Types L and M, water tube, drawn temper.
  - 1. Copper Pressure Fittings: ASME B16.18, cast-copper-alloy or ASME B16.22, wrought-copper, solder-joint fittings. Furnish wrought-copper fittings if indicated.
  - 2. Bronze Flanges: ASME B16.24, Class 150, with solder-joint end. Furnish Class 300 flanges if required to match piping.
  - 3. Copper Unions: MSS SP-123, cast-copper-alloy, hexagonal-stock body, with ball-and-socket, metal-to-metal seating surfaces and solder-joint or threaded ends.
  - 4. Copper, Grooved-End Fittings: ASTM B 75 copper tube or ASTM B 584 bronze castings.
  - 5. Copper-Tubing, Keyed Couplings: Copper-tube dimensions and design similar to AWWA C606. Include ferrous housing sections, gasket suitable for hot water, and bolts and nuts.



- C. Mechanically formed copper or steel tee connections are not acceptable.

### 2.3 PEX DOMESTIC WATER PIPING

- A. Manufacturers: Subject to compliance with requirements, provide products by one of the following. PEX-a manufacturer system warranty shall cover tubing for a duration of 30 years from the date of installation.

1. Uponor Wirsbo hePEX (Basis of Design)
2. Rehau
3. Watts

- B. Code approved:

1. International Code Conference (ICC) – International Plumbing Code (IPC)
2. Uniform Plumbing Code (UPC)
3. Comply with ANSI/NSF Standard 14.
4. Comply with ANSI/NSF Standard 61
5. Certification of flame spread/smoke development rating of 25/50 in accordance with ASTM E84.

- C. Tubing

1. Material: Crosslinked polyethylene (PEX) manufactured by PEX-a or Engel method
2. Type: Wirsbo AQUAPEX
3. Material Standard: Manufactured in accordance with ASTM F876 and ASTM F877 and tested for compliance by an independent third party agency
4. Standard grade hydrostatic design and pressure ratings from PPI
5. Fire-rated assembly listings in accordance with ANSI/UL 263.
6. Minimum Bend Radius (cold bending): No less than six times the outside diameter. Use a bend support as supplied by the PEX tubing manufacturer for tubing with a bend radius less than stated.
7. Nominal inside diameter: Provide tubing with nominal inside diameter, in accordance with ASTM F876 as indicated.

- D. Fittings

1. Material: Fitting assembly is manufactured from material listed in paragraph 5.1 of ASTM F1960.
2. Material Standard: Comply with ASTM F1960.
3. Type: PEX-a cold expansion fitting. Assembly consists of the appropriate ProPEX insert with a corresponding ProPEX Ring.

- E. Manifolds

1. Material
  - a. Type L copper body with UNS 3600 series brass ProPEX outlet connections
  - b. Engineered Plastic (EP) body with ProPEX outlet connections

2. Manifold Type
  - a. Uponor ProPEX Copper Manifold
  - b. Uponor engineered plastic (EP) Manifold
3. All manifolds manufactured with the appropriate-sized ProPEX fittings on the manifold supply inlets.

F. Accessories

1. Angle stops and straight stops that are compatible with PEX tubing are supplied by the PEX tubing manufacturer.
2. Bend supports designed for maintaining tight radius bends are supplied by the PEX tubing manufacturer.
3. ProPEX expander tool to install the ASTM F1960 compatible fittings are supplied by the PEX tubing manufacturer.
4. The tubing manufacturer provides clips and/or PEX rails for supporting tubing runs.
5. All horizontal tubing hangers and riser clamps are epoxy-coated material.

## 2.4 VALVES

A. Ball Valves

1. The valve body and adapter shall be constructed using Lead Free brass. Lead Free ball valves shall comply with state codes and standards, where applicable, requiring reduced lead content.
2. ½" to 2" ball valves: 2-piece full port Lead Free brass ball valves: The valve must have a blowout proof pressure retaining 316 stainless steel stem, 316 stainless steel ball, virgin PTFE seats, seals, stem packing seal and thrust washer. Valve must have adjustable packing. Valves with O-ring stem seal only are not acceptable. Pressure rating no less than 600psi WOG non-shock, 150psi WSP. Valve shall be manufactured to the MSS-SP-110 standard and shall be a Watts Series LFB6080 (threaded) or LFB6081 (solder).
3. Valve sizes 2-1/2" to 4" threaded, shall be rated to 400psi WOG non-shock and 125psi WSP. Valve sizes 2-1/2" to 3" solder shall be rated to 400psi WOG non-shock and 125psi WSP. Valve shall be a Watts Series LFFBV-3C (threaded) or LFFBVS-3C (solder).
4. Provide locking handle where indicated.
5. Comply with MSS SP-110.

B. Swing check valves:

1. Construct pressure containing parts of Valves as follows: Bronze Valves: 125 or 150 psi: ANSI/ASTM B 62; Iron Body Valves: ANSI/ASTM A-126, Grade B.
2. Check valves shall be lead free.
3. Comply with the following standards for design, workmanship, material and testing: Bronze Valves: MSS SP – 80; Cast Iron Valves: MSS SP – 71
4. Construct valves of pressure casting free of any impregnating materials. Construct disc and hanger as one piece. Support hanger pins by removable side plug.

- C. Refer to Division 22 Section "Plumbing Specialties" for balancing and drain valves.

### PART 3 - EXECUTION

#### 3.1 PIPING APPLICATIONS

- A. Transition and special fittings with pressure ratings at least equal to piping rating may be used in applications below, unless otherwise indicated.
- B. Mechanically formed tee-branch outlets and brazed joints shall not be used.
- C. Aboveground Domestic Water or Non-Potable Water Piping: Use Type L copper or PEX with cold formed expansion fittings..

#### 3.2 VALVE APPLICATIONS

- A. Drawings indicate valve types to be used. Where specific valve types are not indicated, the following requirements apply:
  - 1. Shutoff Duty: Use bronze ball valves.
  - 2. Hot-Water-Piping, Balancing Duty.
  - 3. Drain Duty: Hose-end drain valves.

#### 3.3 VALVE INSTALLATION

- A. Provide sectional valve close to water main on each branch and riser serving plumbing fixtures or equipment.
- B. Provide shutoff valve on each water supply to equipment and on each water supply to plumbing fixtures without supply stops.
- C. Provide hose end drain valves for equipment, at base of each water riser, at low points in horizontal piping, and where required to drain water piping.

#### 3.4 PIPING INSTALLATION

- A. Refer to Division 22 Section "Common Work Results for Plumbing" for basic piping installation.
- B. Provide dielectric fittings as specified in Section 230500.
- C. Provide aboveground domestic water piping level and plumb.
- D. Provide firestopping as per Section 230500 "Common Work Results for HVAC".

- E. Fill water piping. Check components to determine that they are not air bound and that piping is full of water.
- F. Perform the following steps before operation:
  - 1. Close drain valves, hydrants, and hose bibbs.
  - 2. Open shutoff valves to fully open position.
  - 3. Open throttling valves to proper setting.
  - 4. Remove plugs used during testing of piping and plugs used for temporary sealing of piping during installation.
  - 5. Remove and clean strainer screens. Close drain valves and replace drain plugs.
- G. Check plumbing equipment and verify proper settings, adjustments, and operation. Do not operate water heaters before filling with water.
- H. Check plumbing specialties and verify proper settings, adjustments, and operation.

### 3.5 JOINT CONSTRUCTION

- A. Refer to Division 22 Section “Common Work Results for Plumbing” for basic piping joint construction.
- B. Soldered Joints: Use ASTM B 813, water-flushable, lead-free flux; ASTM B 32, lead-free-alloy solder; and ASTM B 828 procedure, unless otherwise indicated.
- C. Joints shall be fabricated, joined, and tested per manufacturer’s instructions.

### 3.6 PEX PIPING INSTALLATION

- A. Provide PEX tubing in accordance with the tubing manufacturer's recommendations and as indicated in the installation handbook.
- B. Use grommets or sleeves at the penetration for PEX tubing passing through metal studs.
- C. Protect PEX tubing with sleeves where abrasion may occur. Use strike protectors where PEX tubing penetrates a stud or joist and has the potential for being struck with a screw or nail.
- D. Use tubing manufacturer-supplied bend supports where bends are less than six times the outside tubing diameter.
- E. PEX-a Piping Hanger Spacing: Provide hangers for PEX-a piping with the following maximum spacing:
  - 1. 1 inch and below: Maximum span, 32 inches.
  - 2. 1¼ inch and above: Maximum span, 48 inches.
  - 3. PEX-a Piping Hanger Spacing with PEX-a Support Channel: Provide hangers for PEX-a piping with horizontal support channel in accordance with local jurisdiction and

manufacturer's recommendations, with the following maximum spacing: Maximum span, 8 feet.

- F. PEX-a Riser Supports: Provide CTS riser clamps at the base of each floor and at the top of every other floor. Provide mid-story guides between each floor.
- G. Pipe Joint Construction: PEX-a Connections: Provide per manufacturer's recommendations. Use manufacturer-recommended cold-expansion tool for F1960 connections.
- H. Pressurize PEX tubing with air in accordance with applicable codes or in the absence of applicable codes to a pressure of 25 psi above normal working pressure of the system. Comply with safety precautions when pressure testing, including use of compressed air, where applicable. Do not use water to pressurize the system if ambient air temperature has the possibility of dropping below 32°F.

### 3.7 HANGER AND SUPPORT INSTALLATION

- A. Hanger, support, and anchor devices are specified in Division 22 Section "Hangers and Supports."

### 3.8 CONNECTIONS

- A. Drawings indicate general arrangement of piping, fittings, and specialties.
- B. Provide piping adjacent to equipment and machines to allow service and maintenance.
- C. Use transition fitting to join dissimilar piping materials.
- D. Connect water piping in sizes indicated, but not smaller than sizes of unit connections.
- E. Provide shutoff valve and union for each connection.

### 3.9 FIELD QUALITY CONTROL

- A. Follow local code requirements.
- B. Inspect domestic water piping as follows:
  - 1. Do not enclose, cover, or put piping into operation until it is inspected and approved by authorities having jurisdiction.
  - 2. During installation, notify authorities having jurisdiction at least 24 hours before inspection must be made. Perform tests specified below in presence of authorities having jurisdiction:
    - a. Roughing-in Inspection: Arrange for inspection of piping before concealing or closing-in after roughing-in and before setting fixtures.

- b. Final Inspection: Arrange for final inspection by authorities having jurisdiction to observe tests specified below and to ensure compliance with requirements.
  3. Reinspection: If authorities having jurisdiction find that piping will not pass test or inspection, make required corrections and arrange for reinspection.
  4. Reports: Prepare inspection reports and have them signed by authorities having jurisdiction.
- C. Test domestic water piping as follows:
  1. Test for leaks and defects in new piping and parts of existing piping that have been altered, extended, or repaired. If testing is performed in segments, submit separate report for each test, complete with diagram of portion of piping tested.
  2. Leave uncovered and unconcealed new, altered, extended, or replaced domestic water piping until it has been tested and approved. Expose work that was covered or concealed before it was tested.
  3. Cap and subject piping to static water pressure of 50 psig above operating pressure, without exceeding pressure rating of piping system materials. Isolate test source and allow to stand for four hours. Leaks and loss in test pressure constitute defects that must be repaired.
  4. Repair leaks and defects with new materials and retest piping or portion thereof until satisfactory results are obtained.
  5. Prepare reports for tests and required corrective action.

### 3.10 CLEANING

- A. Clean interior of domestic water piping system. Remove dirt and debris as work progresses. Clean and disinfect domestic water piping per code requirements or administrative authority requirements. Sample procedure as indicated:
  1. Purge new piping and parts of existing domestic water piping that have been altered, extended, or repaired before using.
  2. Use purging and disinfecting procedures prescribed by authorities having jurisdiction or, if methods are not prescribed, procedures described in either AWWA C651 or AWWA C652 or as described below:
    - a. Flush piping system with clean, potable water until dirty water does not appear at outlets.
    - b. Fill and isolate system according to either of the following: Fill system or part thereof with water/chlorine solution with at least 50 ppm of chlorine. Isolate with valves and allow to stand for 24 hours. Fill system or part thereof with water/chlorine solution with at least 200 ppm of chlorine. Isolate and allow to stand for three hours.
    - c. Flush system with clean, potable water until no chlorine is in water coming from system after the standing time.
    - d. Submit water samples in sterile bottles to authorities having jurisdiction. Repeat procedures if biological examination shows contamination.

- B. Prepare and submit reports of purging and disinfecting activities.

END OF SECTION 221116

September 21, 2016



## SECTION 221119 - PLUMBING SPECIALTIES

### PART 1 - GENERAL

#### 1.1 RELATED DOCUMENTS

- A. Drawings and general provisions of the Contract, including General and Supplementary Conditions and Division 1 Specification Sections, apply to this Section.
- B. Related Sections include the following: Division 22 Sections.

#### 1.2 SUMMARY

- A. This Section includes plumbing specialties.

#### 1.3 PERFORMANCE REQUIREMENTS

- A. Provide components and installation capable of producing piping systems with following minimum working-pressure ratings, unless otherwise indicated:
  - 1. Domestic Water Piping: 125 psig.
  - 2. Sanitary Waste and Vent Piping: 10-foot head of water.

#### 1.4 ACTION SUBMITTALS

- A. Product Data: Include rated capacities and shipping, installed, and operating weights. Indicate materials, finishes, dimensions, required clearances, and methods of assembly of components; and piping and wiring connections.

#### 1.5 CLOSEOUT SUBMITTALS

- A. Operation and Maintenance Data
- B. Field test reports.

#### 1.6 QUALITY ASSURANCE

- A. Plumbing specialties shall bear label, stamp, or other markings of specified testing agency.
- B. Electrical Components, Devices, and Accessories: Listed and labeled as defined in NFPA 70, Article 100, by a testing agency acceptable to authorities having jurisdiction, and marked for intended use.

- C. Comply with local building and plumbing codes.
- D. ASME Compliance: Comply with ASME B31.9, "Building Services Piping," for piping materials and installation.
- E. Water line components shall be lead-free.
- F. NSF Compliance: Comply with NSF 14, "Plastics Piping Components and Related Materials," for plastic domestic water piping components. Include marking "NSF-PW" on plastic potable-water piping and "NSF-DWV" on plastic drain, waste, and vent piping. Comply with NSF 61, "Drinking Water System Components--Health Effects, Sections 1 through 9," for potable domestic water plumbing specialties.

## PART 2 - PRODUCTS

### 2.1 ACCESS PANELS

- A. Provide access panels to concealed valves, cleanouts, and components that require service access. All components shall have proper access in accordance with manufactures' recommendations. Refer to Section 220500.

### 2.2 BALANCING VALVES

#### A. DHW Recirculation Balancing Valves

1. Furnish and install as indicated on the plans, Circuit Solver in the domestic hot water piping. Circuit Solver shall be self-contained and fully automatic without additional piping or control mechanisms. Valve shall be Circuit Solver as manufactured by ThermOmegaTech or equivalent.
2. Circuit Solver shall regulate the flow of recirculated domestic hot water based on water temperature entering Circuit Solver regardless of system operating pressure.
3. When fully closed valve shall bypass a minimum flow to maintain dynamic control of the recirculating loop and provide a means for system sanitizing.
4. Valve shall be factory adjustable from 105°F to 140°F as required by project conditions. Valve shall modulate between open and closed position within a 10°F range.
5. Valve body and all internal components shall be constructed of stainless steel with major components constructed of type 303 stainless steel.
6. Valve shall be rated to 200 PSIG maximum working pressure. Valve s shall be rated to 300°F maximum working temperature.
7. Valve s shall be standard tapered female pipe thread, NPT.
8. Circuit Solver shall be ANSI/AWWA C800 compliant. Circuit Solvers shall be NSF-61 certified with zero lead content for use in all domestic water systems.
9. Thermal actuator shall be spring operated and self-cleaning, delivering closing thrust sufficient to keep orifice opening free of scale deposits. Thermal actuator shall be rated for a minimum of 200,000 cycles.

## 2.3 STRAINERS FOR DOMESTIC WATER PIPING

- A. Y-type strainer shall be domestically manufactured, and conform to MIL-S-16293, and be ANSI 3rd party certified to comply with states' lead plumbing law 0.25% maximum weighted average lead content requirement. The main body shall be low lead bronze (ASTM B 584), the access cover shall be yellow brass (ASTM B 16) or cast bronze (ASTM B 584), the strainer screen shall be 300 series stainless steel, 20 mesh. Screens shall be accessible for cleaning without removing the device from the line. The "Y" type strainer shall be a WILKINS Model YBXL.  
Drain: Pipe plug.

## 2.4 HYDRANTS AND HOSE BIBBS

- A. Manufacturers:
1. Josam Co.
  2. Murdock, Inc.
  3. Simmons Manufacturing Co.
  4. Smith, Jay R. Mfg. Co.
  5. Tyler Pipe; Wade Div.
  6. Watts Industries, Inc.; Drainage Products Div.
  7. Woodford Manufacturing Co.
  8. Zurn
  9. MAPA Products
- B. General: ASME A112.21.3M, key-operation hydrant with pressure rating of 125 psig.
1. Inlet: NPS 3/4 or NPS 1 threaded or solder joint.
  2. Outlet: ASME B1.20.7, garden-hose threads.
  3. Operating Keys: One with each key-operation hydrant.
- C. Hose Bibbs: Bronze body with replaceable seat disc complying with ASME A112.18.1M for compression-type faucets. Include NPS 1/2 threaded or solder-joint inlet, of design suitable for pressure of at least 125 psig; integral non-removable, drainable hose-connection vacuum breaker; and garden-hose threads complying with ASME B1.20.7 on outlet. Chrome plated, wheel handle, include integral wall flange.

## 2.5 WATER HAMMER ARRESTORS

- A. Lead-free 0.25% maximum weighted average lead content requirement, consist of a copper body with a low lead brass hexagonal male pipe threaded inlet, an acetal, polycarbonate or low lead brass piston with Buna Nitrile or EPDM O-rings and lead free solder; ASSE® Listed 1010, ANSI A112.26.1. The device shall be pre-charged and sealed at the factory. The Water Hammer Arrester shall be a WILKINS Model 1250XL.

## 2.6 MISCELLANEOUS SANITARY DRAINAGE PIPING SPECIALTIES

- A. Open Drains:

1. Description: Pipe fittings assembled to make a trapped receptacle similar to a floor drain but usually without a grate. They are installed with the top above the floor level, so they are not a substitute for a floor drain.
2. Shop or field fabricate from ASTM A 74, Service class, hub-and-spigot, cast-iron, soil-pipe fittings. Include P-trap, hub-and-spigot riser section; and where required, increaser fitting joined with ASTM C 564, rubber gaskets.
3. Size: Same as connected waste piping with increaser fitting of size indicated.

B. Air-Gap Fittings:

1. Standard: ASME A112.1.2, for fitting designed to ensure fixed, positive air gap between installed inlet and outlet piping.
2. Size: Same as connected waste piping and with inlet large enough for associated indirect waste piping.
3. Dishwasher: ASSE 1021, fitting suitable for use with domestic dishwashers and for deck mounting; with plastic body, chrome-plated brass cover; and capacity of at least 5 gpm; and inlet pressure of at least 5 psig at temperature of at least 140°F. Provide ports for garbage disposal or dishwasher hoses as required; Airgap International, Inc. or approved equal.
4. Small AC condensate drain into sink trap: Airgap International, Inc. Drain Boa, Eco-Tech, or equal; Inlet port directly accepts 3/8" poly tubing. Dual plumbing code listed sink tailpiece fitting. Listed by NSF® and UPC®.
5. Fixed Air-Gap Fittings: Zurn Z1024/Z1025 or Precision Plumbing Products; manufactured cast-iron or bronze drainage fitting with semi-open top with threads or device to secure drainage inlet piping in top and bottom spigot or threaded outlet larger than top inlet. Include design complying with ASME A112.1.2 that will provide fixed air gap between installed inlet and outlet piping.

## 2.7 DRAIN VALVES

A. Ball-Valve-Type, Hose-End Drain Valves:

1. Standard: MSS SP-110 for standard-port, two-piece ball valves.
2. Pressure Rating: 400-psig minimum CWP.
3. Size: NPS 3/4.
4. Body: Copper alloy.
5. Ball: Chrome-plated brass.
6. Seats and Seals: Replaceable.
7. Handle: Vinyl-covered steel.
8. Inlet: match piping.
9. Outlet: Threaded, short nipple with garden-hose thread complying with ASME B1.20.7 and cap with brass chain.

## 2.8 CLEANOUTS

A. Manufacturers

1. Zurn

2. Smith, Jay R. Mfg. Co.
  3. Josam Co.
  4. Tyler Pipe, Wade Div.
  5. Watts Industries, Inc., Drainage Products Div.
  6. Mifab
  7. Wade
- B. Cleanouts shall be easily accessible and shall be gastight and watertight. Provide a minimum clearance of 24 inches for the rodding. Size of cleanout shall be same as pipe size through 4". Pipes 4" and larger shall have 4" cleanouts.
- C. Floor Cleanouts: Mifab C1000 Series floor cleanout with heavy-duty nickel-bronze or stainless steel adjustable top.
1. Compliance: ANSI/ASME A112.36.2M.
  2. Load Rating: Up to 7,499 pounds.
  3. Body: A1, 8-inch diameter body. Lacquered, ASTM A 48, Class 25 cast iron body with anchor flange. O-ring secondary gasket seal. 4-inch; 4"NPS machined integral body threads.
  4. Combined Access Cover and Plug Top Assembly: Heavy-duty, round, 5-inch diameter; square, 5-inch by 5-inch (for tile insertion), adjustable, Type 304 stainless steel top assembly with No. 4 satin finish. Neoprene primary gasket seal. Vandal-resistant stainless steel screws.
  5. When a waterproof membrane is used in the floor system, provide clamping collars on the cleanouts.
  6. In carpeted areas, provide carpet cleanout markers.
- D. Cleanouts shall consist of "Y" fittings and (1/8 inch) bends with brass or bronze screw plugs.
- E. Provide cleanouts at or near the base of the vertical stacks with the cleanout plug located approximately 24 inches above the floor. If there are no fixtures installed on the lowest floor, the cleanout shall be installed at the base of the stack Cleanout shall consist of sanitary tees. . Extend the cleanouts to the wall access cover; Mifab 1400 Series.
- F. In horizontal runs above grade, cleanouts shall consist of cast brass tapered screw plug in fitting or caulked/no hub cast iron ferrule. Plain end (no-hub) piping in interstitial space or above ceiling may use plain end (no-hub) blind plug and clamp.

## 2.9 FLOOR DRAINS

- A. Manufacturers
1. Zurn Industries, Inc
  2. Jay R. Smith Mfg. Co.
  3. Tyler Pipe, Wade Div.
  4. Watts Industries, Inc
  5. Mifab
  6. Wade

- B. Floor drains shall comply with ASME A112.21.1M. Provide outlet type as required by piping system used.
- C. Provide 1/2" trap primer connection as indicated on plans. Size: Same as floor drain outlet with NPS 1/2 side inlet.
- D. Light Duty FD-1: bathroom and finished areas; ZURN ZN415BZ-P, Dura-Coated cast iron body with 2" bottom outlet, combination invertible membrane clamp and adjustable collar with seepage slots, and "TYPE BZ" polished nickel bronze light-duty leveling strainer.

## 2.10 TRAP SEAL PRIMER VALVES

### 1. Manufacturers:

- a. Precision Plumbing Products, Inc.
- b. Josam Co.
- c. Watts.
- d. Zurn
- e. Mifab
- f. Sioux Chief

B. Trap primer make up lines must have a continuous slope to the floor drain.

### C. Water Saver Trap Primer:

- 1. Precision Plumbing Products 1-1/2" Tail Piece floor drain trap priming assembly; provided with a braided 1/2" stainless steel flexible priming make up water line with 5/8" compression fitting, and chrome plated escutcheons for both the wall tube and make up water line.
- 2. Minimum discharge rate at 0.5 gpm is 2.5 oz.
- 3. Standard: ASSE 1044.

## PART 3 - EXECUTION

### 3.1 INSTALLATION

- A. Refer to Division 22 Section "Common Work Results for Plumbing" for piping joining materials, joint construction, and basic installation requirements.
- B. Provide air-gap fittings on draining-type backflow preventers and on indirect-waste piping discharge into sanitary drainage system.
- C. Trap primers:
  - 1. Provide floor-drain, trap-seal primer fittings on inlet to floor drains that require trap-seal primer connection. Primers shall be accessible for maintenance.

2. Provide trap seal primers in accordance with manufacturer's instructions.
  3. Cycle trap seal primers a minimum of 6 times to ensure optimum performance.
  4. Ensure flux and other debris is removed.
  5. Do not install trap seal primers closer than 40 feet apart when using same potable water supply line.
  6. Mount trap seal primers in a vertical position 1 foot above finished floor for every 20 feet of floor drain trap make-up water line.
  7. Provide union connection above trap seal primers.
  8. Provide line shut-off valve upstream of trap seal primers to shut off water supply when performing maintenance on trap seal primers.
  9. Avoid direct installation to prevent foreign material from entering directly into trap seal primers.
- D. Cleanouts:
1. Provide cleanouts per plumbing code.
  2. Provide cleanout deck plates with top flush with finished floor, for floor cleanouts for piping below floors.
  3. Provide cleanout wall access covers, of types indicated, with frame and cover flush with finished wall, for cleanouts located in concealed piping.
  4. Provide flashing flange and clamping device with each stack and cleanout passing through floors with waterproof membrane.
- E. Provide floor drains in accordance with manufacturer's instructions at locations indicated on the drawings.
1. Protect installed floor drains from damage during construction.
  2. Provide floor drains at low points of surface areas to be drained.
  3. Provide floor drains plumb, level, and to correct elevation.
  4. Ensure top of floor drains are flush with top of finished floor.
  5. Provide floor drains using manufacturer's supplied hardware.
  6. Coordinate depressed/pitched slab with concrete contractor.
  7. Provide floor-drain flashing collar or flange so no leakage occurs between drain and adjoining flooring. Maintain integrity of waterproof membranes where penetrated.
  8. Provide individual traps for floor drains connected to sanitary building drain, unless otherwise indicated.
- F. Fasten wall-hanging plumbing specialties securely to supports attached to building substrate if supports are specified and to building wall construction if no support is indicated. Fasten recessed-type plumbing specialties to reinforcement built into walls. Provide wood-blocking reinforcement for wall mounting and recessed-type plumbing specialties.
- G. Provide individual shutoff valve in each water supply to plumbing specialties. Provide shutoff valves in accessible locations.
- H. Provide air vents at piping high points. Include ball valve in inlet.
- I. Provide traps on plumbing specialty drain outlets.

- J. Water hammer arrestors shall be installed at flush valve water closets, as shown on the plans and as recommended by Plumbing & Drainage Institute Standard PDI-WH-201. Locate units at the end of branch lines, between the last two fixtures served. Size units based on fixture unit total of branch. All branch pipes serving flush valve water closets shall have water hammer arrestors.
- K. Provide escutcheons at wall, floor, and ceiling penetrations in exposed finished locations and within cabinets and millwork. Use deep-pattern escutcheons if required to conceal protruding pipe fittings.
- L. Circuit Solve DHW Recirculation Balancing Valve:
  - 1. Provide Circuit Solver in each domestic hot water return piping branch beyond last hot water device in that branch.
  - 2. Provide suitable line size isolation valves, unions, and strainer.
  - 3. Provide suitable access panel as required in non-accessible ceilings and walls.

### 3.2 CONNECTIONS

- A. Piping installation requirements are specified in other Division 22 Sections. Drawings indicate general arrangement of piping, fittings, and specialties.
- B. Provide piping adjacent to equipment to allow service and maintenance.
- C. Connect plumbing specialties to piping specified in other Division 22 Sections.
- D. Connect plumbing specialties and devices that require power according to Electrical Specification Sections.

### 3.3 FIELD QUALITY CONTROL

- A. Test each trap primer according to authorities having jurisdiction and the device's reference standard.
- B. Domestic water piping specialties will be considered defective if they do not pass tests and inspections.
- C. Prepare test and inspection reports.
- D. Set field-adjustable temperature set points of temperature-actuated, water mixing valves.

END OF SECTION 221119



## SECTION 221316 – PLUMBING SANITARY AND STORM PIPING

### PART 1 - GENERAL

#### 1.1 RELATED DOCUMENTS

- A. Drawings and general provisions of the Contract, including General and Supplementary Conditions and Division 1 Specification Sections, apply to this Section.
- B. Related Sections include the following:
  - 1. Division 22 Section "Common Work Results for Plumbing"
  - 2. Division 22 Section "Plumbing Specialties" for soil, waste, and vent piping systems specialties.

#### 1.2 SUMMARY

- A. This Section includes soil and waste, sanitary drainage and vent piping inside the building and to locations indicated.
- B. This Section includes storm-drainage piping inside the building and to locations indicated.
- C. Drawings show the general layout of piping and accessories but do not show all required fittings and offsets that may be necessary to connect piping to equipment and to coordinate with other trades. Fabricate piping based on field measurements. Provide all necessary fittings and offsets.
- D. General layout shown, provide piping to fixtures as required by the Maine Plumbing Code. A licensed master plumber shall perform or supervise the work and provide layouts, piping, and fittings as required by code.

#### 1.3 PERFORMANCE REQUIREMENTS

- A. Comply with the utility requirements for the connection of to the municipal utility services. Obtain and pay for all necessary permits from the applicable municipal department. Obtain authority to connect to their existing mains.
- B. Provide components and installation capable of producing piping systems with working-pressure ratings per local plumbing code.

#### 1.4 SUBMITTALS

- A. Product Data: For pipe, tube, fittings, and couplings.
- B. Field Test Reports: Indicate and interpret test results for compliance with performance requirements.

## 1.5 QUALITY ASSURANCE

- A. Piping materials shall bear label, stamp, or other markings of specified testing agency.
- B. Comply with the UPC 2009 edition, subject to the exclusions and amendments set forth by the Maine Plumbers Examining Board.
- C. Comply with NSF 14, "Plastics Piping Systems Components and Related Materials," for plastic piping components. Include marking with "NSF-DWV" for plastic drain, waste, and vent piping; "NSF-drain" for plastic drain piping; "NSF-tubular" for plastic continuous waste piping; and "NSF-sewer" for plastic sewer piping.

## PART 2 - PRODUCTS

### 2.1 PIPING MATERIALS

- A. Refer to Part 3 "Piping Applications" Article for applications of pipe, tube, fitting, and joining materials.

### 2.2 CAST-IRON SOIL PIPING

#### A. Hubless

- 1. Hubless Cast Iron pipe and fittings shall be manufactured from gray cast iron and shall conform to ASTM A-888 and CISPI Standard 301. All pipe and fittings shall be marked with the collective trademark of the Cast Iron Soil Pipe Institute.
- 2. Hubless couplings shall conform to CISPI Standard 310 for standard couplings or ASTM C-1540 for heavy duty couplings where indicated. Gaskets shall conform to ASTM C-564. All pipe and fittings to be produced by a single manufacturer and are to be installed in accordance with manufacturer's recommendations and local code requirements. Couplings shall be installed in accordance with the manufacturer's band tightening sequence and torque. Tighten bands with a properly calibrated torque limiting device.

#### B. Hub and Spigot Cast Iron Soil Pipe and Fittings:

- 1. Hub and Spigot Cast Iron pipe and fittings shall be manufactured from gray cast iron and shall conform to ASTM A-74. All pipe and fittings shall be marked with the collective trademark of the Cast Iron Soil Pipe Institute. Pipe and fittings to be Service (SV) Extra Heavy (XH)
- 2. Joints can be made using a compression gasket manufactured from a neoprene elastomer meeting the requirements of ASTM C-564 or lead and oakum. All pipe and fittings to be produced by a single manufacturer and are to be installed in accordance with manufacturer's recommendations and local code requirements. The system shall be hydrostatically tested after installation to 10 ft. of head (4.3 psi maximum).

## 2.3 PVC DRAINAGE PIPING

- A. Pipe and fittings shall be manufactured from PVC compound with a cell class of 12454 per ASTM D-1784 and conform with National Sanitation Foundation (NSF) standard 14. Pipe shall be iron pipe size (IPS) conforming to ASTM D-1785 and ASTM D-2665. Fittings shall conform to ASTM D-2665.
- B. All pipe and fittings to be produced by a single manufacturer and to be installed in accordance with manufacturer's recommendations and local code requirements. Solvent cements shall conform to ASTM D-2564, primer shall conform to ASTM F-656. The system to be manufactured by Charlotte Pipe and Foundry Co. or approved equal; and shall be intended for non-pressure drainage applications where the temperature will not exceed 140°F.

## PART 3 - EXECUTION

### 3.1 PIPING APPLICATIONS

- A. Transition and special fittings with pressure ratings at least equal to piping pressure ratings may be used in applications below, unless otherwise indicated.
- B. Use PVC or cast iron. PVC is not permitted in return air plenums.
- C. Storm Drain Piping, heat traced: Cast iron

### 3.2 PIPING INSTALLATION

- A. Refer to Division 22 Section "Common Work Results for Plumbing" for basic piping installation.
- B. Provide firestopping as per Section 230500 "Common Work Results for HVAC".
- C. Install cast-iron soil piping according to CISPI's "Cast Iron Soil Pipe and Fittings Handbook," Chapter IV, "Installation of Cast Iron Soil Pipe and Fittings."
- D. Install PVC soil and waste drainage and vent piping according to ASTM D 2665.
- E. Make changes in direction for soil and waste drainage and vent piping using appropriate branches, bends, and long-sweep bends. Sanitary tees and short-sweep 1/4 bends may be used on vertical stacks if change in direction of flow is from horizontal to vertical. Use long-turn, double Y-branch and 1/8-bend fittings if 2 fixtures are installed back to back or side by side with common drain pipe. Straight tees, elbows, and crosses may be used on vent lines. Do not change direction of flow more than 90 degrees. Use proper size of standard increasers and reducers if pipes of different sizes are connected. Reducing size of drainage piping in direction of flow is prohibited.
- F. Install drainage and vent piping at the minimum slopes as required by the local plumbing code.

- G. Do not enclose, cover, or put piping into operation until it is inspected and approved by authorities having jurisdiction.

### 3.3 JOINT CONSTRUCTION

- A. Refer to Division 22 Section "Common Work Results for Plumbing" for basic piping joint construction.
- B. Cast-Iron, Soil-Piping Joints: Make joints according to CISPI's "Cast Iron Soil Pipe and Fittings Handbook," Chapter IV, "Installation of Cast Iron Soil Pipe and Fittings." Gasketed Joints: Make with rubber gasket matching class of pipe and fittings. Hubless Joints: Make with rubber gasket and sleeve or clamp.

### 3.4 HANGER AND SUPPORT INSTALLATION

- A. Hanger, support, and anchor devices are specified in Division 22 Section "Hangers and Supports."

### 3.5 CONNECTIONS

- A. Drawings indicate general arrangement of piping, fittings, and specialties.
- B. Use transition fitting to join dissimilar piping materials.
- C. Connect drainage and vent piping to fixtures and equipment as shown on the plans.
- D. Connect drainage piping in sizes indicated, but not smaller than required by plumbing code.

### 3.6 FIELD QUALITY CONTROL

- A. During installation, notify authorities having jurisdiction at least 24 hours before inspection must be made. Perform tests specified below in presence of authorities having jurisdiction.
  - 1. Roughing-in Inspection: Arrange for inspection of piping before concealing or closing-in after roughing-in and before setting fixtures.
  - 2. Final Inspection: Arrange for final inspection by authorities having jurisdiction to observe tests specified below and to ensure compliance with requirements.
- B. Test piping according to procedures of authorities having jurisdiction or, in absence of published procedures, as follows:
  - 1. Test for leaks and defects in new piping and parts of existing piping that have been altered, extended, or repaired. If testing is performed in segments, submit separate report for each test, complete with diagram of portion of piping tested.
  - 2. Leave uncovered and unconcealed new, altered, extended, or replaced drainage and vent piping until it has been tested and approved. Expose work that was covered or concealed before it was tested.

3. Roughing-in Plumbing Test Procedure: Test piping on completion of roughing-in. Close openings in piping system and fill with water to point of overflow, but not less than 10-foot head of water. From 15 minutes before inspection starts to completion of inspection, water level must not drop. Inspect joints for leaks.
  4. Finished Plumbing Test Procedure: After plumbing fixtures have been set and traps filled with water, test connections and prove they are gastight and watertight. Plug vent-stack openings on roof and building drains where they leave building. Introduce air into piping system equal to pressure of 1-inch wg. Use U-tube or manometer inserted in trap of water closet to measure this pressure. Air pressure must remain constant without introducing additional air throughout period of inspection. Inspect plumbing fixture connections for gas and water leaks.
  5. Repair leaks and defects with new materials and retest piping, or portion thereof, until satisfactory results are obtained.
- C. Re-inspection: If authorities having jurisdiction find that piping will not pass test or inspection, make required corrections and arrange for re-inspection.
- D. Reports: Prepare inspection reports and have them signed by authorities having jurisdiction.

### 3.7 CLEANING

- A. Clean interior of piping. Remove dirt and debris as work progresses.
- B. Protect drains during remainder of construction period to avoid clogging with dirt and debris and to prevent damage from construction work.
- C. Place plugs in ends of uncompleted piping at end of day and when work stops.

END OF SECTION 221316



## SECTION 224000 - PLUMBING FIXTURES

### PART 1 - GENERAL

#### 1.1 RELATED DOCUMENTS

- A. Drawings and general provisions of the Contract, including General and Supplementary Conditions and Division 1 Specification Sections, apply to this Section.
- B. Related Sections include the following:
  - 1. Division 22 Section "Common Work Results for Plumbing"
  - 2. Section 221116 - Domestic Water Piping: Material and installation of piping systems, valves, and piping specialties.
  - 3. Division 22 Section "Plumbing Specialties" for backflow preventers and specialty fixtures not in this Section.

#### 1.2 SUMMARY

- A. This Section includes Plumbing Fixtures.

#### 1.3 SUBMITTALS

- A. Product Data: Include selected fixture and trim, fittings, accessories, appliances, appurtenances, equipment, and supports and indicate materials and finishes, dimensions, construction details, and flow-control rates for each type of fixture indicated.
- B. Maintenance Data: For plumbing fixtures to include in maintenance manuals specified in Division 1.

#### 1.4 QUALITY ASSURANCE

- A. Source Limitations: Obtain plumbing fixtures, faucets, and other components of each category through one source from a single manufacturer. Exception: If fixtures, faucets, or other components are not available from a single manufacturer, obtain similar products from other manufacturers specified for that category.
- B. Comply with local building and plumbing codes.
- C. Regulatory Requirements: Comply with requirements in ICC A117.1, "Accessible and Usable Buildings and Facilities"; Public Law 90-480, "Architectural Barriers Act"; and Public Law 101-336, "Americans with Disabilities Act"; about plumbing fixtures for people with disabilities.

- D. Regulatory Requirements: Comply with requirements in Public Law 102-486, "Energy Policy Act," about water flow and consumption rates for plumbing fixtures.
- E. NSF Standard: Comply with NSF 61, "Drinking Water System Components--Health Effects," for fixture materials that will be in contact with potable water.
- F. Water line components shall be lead-free.

## 1.5 COORDINATION

- A. Coordinate roughing-in and final plumbing fixture locations, and verify that fixtures can be installed to comply with original design and referenced standards.

## PART 2 - PRODUCTS

### 2.1 GENERAL

#### A. Common Plumbing Fixture Requirements

1. Vitreous china, nonabsorbent, hard-burned, and vitrified throughout the body shall be provided. Porcelain enameled ware shall have specially selected, acid-resisting enamel coating evenly applied on surfaces. No fixture will be accepted that shows cracks, crazes, blisters, thin spots, or other flaws. Fixture color shall be white except as specified herein.
2. Provide combinations of fixtures and trim, faucets, fittings, and other components that are compatible. Fixtures shall be equipped with appurtenances such as traps, faucets, stop valves, and drain fittings.
3. Each fixture and piece of equipment requiring connections to the drainage system shall be equipped with a trap.
4. Brass expansion or toggle bolts capped with acorn nuts shall be provided for supports, and polished chromium-plated pipe, valves, and fittings shall be provided where exposed to view.
5. Fixtures with the supply discharge below the rim shall be equipped with backflow preventers.
6. Fixture supports for off-the-floor fixtures shall be of the chair-carrier type. The carrier shall provide the necessary means of mounting the fixture, with a foot or feet to anchor the assembly to the floor slab. Adjustability shall be provided to locate the fixture at the desired height and in proper relation to the wall. Support plates, in lieu of chair carrier, shall be fastened to the wall structure only where it is not possible to anchor a floor-mounted chair carrier to the floor slab.
7. Provide access panels to concealed valves and components. All components shall have proper access in accordance with manufactures' recommendations. Refer to Section 220500.
8. Mounting heights: Refer to Architectural Plans.

### 2.2 WATER CLOSETS



A. Manufacturers:

1. Toto
2. American Standard
3. Sloan

B. Basis of Design Water Closets **P-1A** and **P-1B**: Wall mounted, elongated front bowl, with eco powered flush valve.



1. Standards: ASME A112.19.2/CSA B45.1 and ASME A112.19.5.
2. Material: Vitreous china. Provide CeFiONtect ceramic glaze.
3. Type: Siphon jet.
4. Style: Flushometer valve.
5. Height: Standard.
6. Rim Contour: Elongated.
7. Water Consumption: 1.28 GPF.
8. Spud Size and Location: NPS 1-1/2; top.
9. Water Closet Carrier: Standard: ASME A112.6.1M. Description: Waste-fitting assembly, as required to match drainage piping material and arrangement with faceplates, couplings gaskets, and feet; bolts and hardware matching fixture. Water-Closet Mounting Height: See Architectural plans.

C. Basis of Design Water Closet **P-1C**: Floor mounted, ADA compliant, low consumption, elongated front bowl, with eco powered flush valve.



1. Standards: ASME A112.19.2/CSA B45.1 and ASME A112.19.5.
2. Material: Vitreous china. Provide CeFiONtect ceramic glaze.
3. Type: Siphon jet.
4. Style: Flushometer valve.

5. Height: Standard.
  6. Rim Contour: Elongated.
  7. Water Consumption: 1.28 GPF.
  8. Spud Size and Location: NPS 1-1/2; top.
  9. Water Closet Carrier: Standard: ASME A112.6.1M. Description: Waste-fitting assembly, as required to match drainage piping material and arrangement with faceplates, couplings gaskets, and feet; bolts and hardware matching fixture. Water-Closet Mounting Height: See Architectural plans.
- D. Flushometer Valves: Toto Model TET1LA32#CP automatic infrared sensor activated, toilet flush valve. Heavy-duty zinc die cast cover with polished chrome finish. Vandal resistant hex head screws. Low water consumption of 1.28 gallons per flush. Automatic sensor adjustment on installation. Manual override button incorporated. Piston valve and solenoid with self-cleaning mechanism. Automatic flush every twenty four hours if not used. Angle stop and vacuum breaker included with accessories. Through the use of hydraulic power, using the valve 12 flushes per day will fully recharge the valve for up to 10 years. Standard: ASSE 1037.
- E. Toilet Seats:
1. Standard: IAPMO/ANSI Z124.5.
  2. Material: Solid polypropylene.
  3. Permanent surface coating that inhibits the growth of stain and odor causing bacteria, mold and mildew on the surface
  4. Type: Commercial (Heavy duty).
  5. Shape: Elongated rim, open front.
  6. Hinge: Check.
  7. Seat Cover: Not required.
  8. Color: White.
- F. Water Closet Carrier: Standard: ASME A112.6.1M. Description: Waste-fitting assembly, as required to match drainage piping material and arrangement with faceplates, couplings gaskets, and feet; bolts and hardware matching fixture. Water-Closet Mounting Height: See Architectural plans.

## 2.3 URINALS

- A. Manufacturers
1. Toto
  2. American Standard, Inc.
  3. Sloan
- B. Basis of Design Urinals **P-2A** and **P-2B**: Toto Model UT105UG, wall hung, back outlet, washout. The wall-mounted, ADA compliant, high-efficiency washout urinal shall be 0.125GPF.



1. Fixture: American Standard Washbrook FloWise Universal Urinal with Everclean
  - a. Standards: ASME A112.19.2/CSA B45.1 and ASME A112.19.5.
  - b. Material: Vitreous china.
  - c. Urinal shall have the CeFiONtect ceramic glaze.
  - d. Water Consumption: 1/8 GPF
  - e. Spud Size and Location: NPS 3/4, top.
  - f. Outlet Size and Location: NPS 2, back.
  - g. Color: #01 Cotton
  
2. Flushometer Valve: Toto Model TEU1UA
  - a. Standard: ASSE 1037.
  - b. 0.125 GPF
  - c. Self-powered hydroelectric flush valve system
  - d. No minimum daily usage requirement
  - e. Durable chrome plated body with tamper-proof screws and solid bronze valve body
  - f. Neutral rough-in and adjustable tail piece connection
  - g. True mechanical flush override
  - h. Smart sensor with self-adjusting detection range
  - i. 6-second detection time to prevent ghost flushing
  - j. ADA compliant
  - k. Minimum Inlet: NPS 3/4.
  - l. Minimum Outlet: NPS 2.
  
3. Support: Type I Urinal Carrier with fixture support plates and coupling with seal and fixture bolts and hardware matching fixture. Include rectangular, steel uprights. Standard: ASME A112.6.1M. Urinal Mounting Height: See Architectural Plans.

2.4 VITREOUS-CHINA LAVATORIES

- A. Lavatory Manufacturers:
  1. Toto
  2. American Standard
  3. Kohler
  
- B. Basis of Design **P-3**: Toto Model LT221
  
- C. Rectangular lavatory, under-counter mounting, front overflow, ADA compliant.



1. Standard: ASME A112.19.2/CSA B45.1.
2. Nominal Size: Oval, 17 by 13 inches.
3. ADA Compliant
4. Front overflow.
5. Mounting assembly complete with installation template and mounting screw set
6. Color: #1 Cotton

D. Lavatory Faucets: Toto TEL121 Series, Helix® M EcoPower® Faucet

1. Standard: ASME A112.18.1/CSA B125.1.
2. Self-generating hydro-powered EcoPower system
3. No minimum daily usage requirement
4. Micro-sensor positioned underneath the spout head for accurate hand detection ensuring smooth and consistent water distribution
5. Vandal resistant aerator housing
6. Durable chrome plated spout body
7. Single-hole mount
8. Kit includes spout body, controller box, and mounting hardware.
9. Provide the Toto Thermostatic Mixing Valve (Model TLT10).

E. Risers: Supply line: supplied by fixture manufacturer, or by McGuire or Brasscraft. Shall be lead-free, loose key standard stop lavatory supply kit, two polished chrome, solid brass angle stops with round wheel handles, two 12" flexible chrome-plated lavatory risers complete with two forged brass with set screw flanges; connections: 1/2" sweat x 3/8" OD.

F. Waste Fittings

1. Standard: ASME A112.18.2/CSA B125.2.
2. Drain: Grid type with NPS 1-1/4 offset and straight tailpiece.
3. Trap: NPS 1-1/2 by NPS 1-1/4; Material: Chrome-plated, two-piece, cast-brass trap and swivel elbow with 0.032-inch- thick brass tube to wall; and chrome-plated, brass or steel wall flange.

## 2.5 STAINLESS STEEL SINKS

A. Sink Manufacturers:

1. Elkay
2. Just Manufacturing Co.

3. Moen

B. Faucet Manufacturers

1. Moen
2. Chicago
3. Kohler
4. American Standard

C. Basis of Design Stainless Steel Counter Sink **P-4**: Elkay ELUHAD161655PD

1. Mounting type: undermount
2. Finish: 18 gauge 304 stainless steel with a lustrous satin finish
3. Drain: perfect drain, rear drain location
4. Mounting brackets included, other standard mounting hardware and silicone sealant not included
5. Sound-shield sound absorbing system
6. Template included - template number 22520
7. Third party certified by IAPMO to meet ASME A112.19.3.



D. Sink Faucet: Moen Model G18273

1. Reflex™ pulldown system offers smooth operation, easy movement and secure docking
2. Metal construction with chrome finish
3. Quick connect installation
4. Pulldown spray with 68" braided hose
5. Flexible supply lines with 3/8" compression fittings
6. High arc spout provides height and reach to fill or clean large pots while pulldown wand provides the maneuverability for cleaning or rinsing
7. 360° rotating spout provides ability to install handle on either side
8. Faucet designed for handle to be mounted on right side
9. Lever style handle; Temperature controlled by 100° arc of handle travel; Operates with less than 5 lbs. of force; Operates in stream or spray mode in the pullout or retracted position
10. Flow is limited to 1.5 gpm max at 60 psi

E. Trim

1. P-trap: McGuire 912CB heavy cast brass adjustable body, with slip nut, with cleanout, box flange and seamless tubular wall bend.
2. Supply line: supplied by fixture manufacturer, or by McGuire or Brasscraft. Shall be lead-free, loose key standard stop lavatory supply kit, two polished chrome, solid brass angle stops with round wheel handles, two 12" flexible chrome-plated lavatory risers complete with two forged brass with set screw flanges.

3. Drain Fitting: type 304 stainless steel body and removable conical basket strainer with metal stem and rubber stopper; fits 3-1/2" opening; polished finish; chrome plated solid brass construction.

## 2.6 MOP SERVICE BASIN

### A. Manufacturers:

1. Zurn
2. Fiat
3. Mustee

### B. Provide check valves at HW and CW connections.

### C. Basis of Design Mop Service Basin **P-5**: Zurn Z1996-24, 24 x 24 x 10" H. Molded high density molded stone basin; PVC drain body, stainless steel strainer, and 3" gasketed outlet connection. Certifications: Meets ANSI Z124.6, CSA listed, and IAPMO listed under file # 3561.

1. Wall Guard (-WG) Provide 20 gage type 304 stainless steel bumpers used to protect walls adjacent to mop basin. Two panels shall be supplied for corner installation
2. Mop holder (-MH): Stainless steel 24" long x 3" wide with three rubber tool grips
3. Bumper Guards (-BS) Provide 20 gage type 304 stainless steel bumper guards to protect top edge of basin.

### D. Chicago Faucets No. 540-LD897SWXFABCP, wall mounted. 8" fixed centers, Hot and cold water sink faucet, chrome plated solid brass construction. 5 3/4" center to center rigid vacuum breaker spout with 3/4" male hose thread and pail hook. 2 3/8" metal lever handles with eight point tapered broach and secured blue and red buttons. Quarter-turn re-buildable compression cartridge, opens and closes 90°, closes with water pressure, features square tapered stem. Straight 2" inlet supply arm with wall flange with 1/2" NPT female thread inlet. Provide atmospheric vacuum breaker. ECAST® construction with less than 0.25% lead content by weighted average. Provide per ADA ANSI/ICC A117.1 requirements and shall be tested and certified to industry standards: ASME A112.18.1/CSA B125.1, California Health and Safety Code 116875 (AB1953-2006), Vermont Bill S.152, and NSF/ANSI 372 Low Lead Content.

## PART 3 - EXECUTION

### 3.1 EXAMINATION

- A. Examine roughing-in of water supply and sanitary drainage and vent piping systems to verify actual locations of piping connections before fixture installation. Use manufacturer's roughing-in data if roughing-in data are not indicated.
- B. Examine walls, floors, and cabinets for suitable conditions where fixtures are to be installed.
- C. Proceed with installation only after unsatisfactory conditions have been corrected.

### 3.2 FIXTURE INSTALLATION - GENERAL

- A. Assemble and support fixtures, trim, fittings, and other components according to manufacturers' written instructions.
- B. Provide fixtures level and plumb according to manufacturers' written instructions and roughing-in drawings.
- C. Provide water-supply piping with stop on each supply to each fixture to be connected to water distribution piping. Attach supplies to supports or substrate within pipe spaces behind fixtures. Provide stops in locations where they can be easily reached for operation.
- D. Provide traps on fixture outlets as required.
- E. Provide escutcheons at piping wall ceiling penetrations in exposed, finished locations and within cabinets and millwork. Use deep-pattern escutcheons if required to conceal protruding fittings. Refer to Division 22 Section "Common Work Results for Plumbing" for escutcheons.
- F. Set floor mounted fixtures in a leveling bed of cement grout as per fixture manufacturer's instructions. Refer to Division 22 Section "Common Work Results for Plumbing" for grout.
- G. Joint Sealing:
  - 1. Seal joints between fixtures and walls, floors, and counters using sanitary-type, one-part, mildew-resistant, silicone sealant.
  - 2. Match sealant color to water-closet color.
  - 3. Comply with sealant requirements specified in Division 9.

### 3.3 WATER CLOSET & URINAL INSTALLATION

- A. Water-Closet Installation:
  - 1. Provide level and plumb according to roughing-in drawings.
  - 2. Provide floor-mounted water closets on bowl-to-drain connecting fitting attachments to piping or building substrate.
  - 3. Provide accessible, wall-mounted water closets at mounting height for handicapped/elderly, according to ICC/ANSI A117.1.
- B. Support Installation:
  - 1. Provide supports, affixed to building substrate, for floor-mounted, back-outlet water closets.
  - 2. Use carrier supports with waste-fitting assembly and seal.
  - 3. Provide wall-mounted, back-outlet water-closet supports with waste-fitting assembly and waste-fitting seals; and affix to building substrate.
- C. Flushometer-Valve Installation:
  - 1. Provide flushometer-valve, water-supply fitting on each supply to each water closet.

2. Attach supply piping to supports or substrate within pipe spaces behind fixtures.
3. Provide lever-handle flushometer valves for accessible water closets with handle mounted on open side of water closet.
4. Provide actuators in locations that are easy for people with disabilities to reach.

D. Provide toilet seats on water closets.

E. Wall Flange and Escutcheon Installation:

1. Provide wall flanges or escutcheons at piping wall penetrations in exposed, finished locations and within cabinets and millwork.
2. Provide deep-pattern escutcheons if required to conceal protruding fittings.

### 3.4 SINKS AND LAVATORIES

A. Provide supports, affixed to building substrate, for wall-mounted lavatories.

B. Seal joints between lavatories, counters, and walls using sanitary-type, one-part, mildew-resistant silicone sealant. Match sealant color to fixture color. Comply with sealant requirements specified in Division 7.

C. Operate and adjust lavatories and controls. Replace damaged and malfunctioning lavatories, fittings, and controls. Adjust water pressure at faucets to produce proper flow.

### 3.5 CONNECTIONS

A. Piping installation requirements are specified in other Division 22 Sections. Drawings indicate general arrangement of piping, fittings, and specialties.

B. Use chrome-plated brass or copper tube, fittings, and valves in locations exposed to view. Plain copper tube, fittings, and valves may be used in concealed locations.

C. Supply and Waste Connections to Plumbing Fixtures: Connect fixtures with water supplies, stops, risers, traps, and waste piping. Use size fittings required to match fixtures. Connect to plumbing piping.

D. Provide plumbing hookups to Fixtures and Equipment Specified in Section 113100 "Residential Appliances". Connect fixtures and equipment with water supplies Use size fittings required to match fixtures and equipment. Connect to plumbing piping.

E. Residential Dishwasher: When the sink is equipped with a garbage disposal unit, the dishwasher waster shall be connected to the inlet side of the disposal after passing through the required air gap fitting. When the sink is not equipped with a garbage disposal unit, the dishwasher waste shall be connected to the continuous waste of the sink using a wye-branch fitting, after passing through the required air gap fitting. The wye branch fitting may be installed in any vertical section of the continuous waste on the inlet side of the trap. The wye branch fitting shall not be installed in a horizontal run.



### 3.6 FIELD QUALITY CONTROL

- A. Verify that installed fixtures are categories and types specified for locations where installed. Check that fixtures are complete with trim, faucets, fittings, and other specified components. Inspect installed fixtures for damage. Replace damaged fixtures and components.
- B. Test installed fixtures after water systems are pressurized for proper operation. Replace malfunctioning fixtures and components, then retest. Repeat procedure until units operate properly.

### 3.7 ADJUSTING

- A. Operate and adjust fixtures. Replace damaged and malfunctioning fixtures, fittings, and controls.
- B. Adjust water pressure to produce proper flow and stream.
- C. Replace washers and seals of leaking and dripping faucets and stops.
- D. Water coolers: Adjust fixture flow regulators for proper flow and stream height. Adjust water-cooler temperature settings.

### 3.8 CLEANING

- A. After completing fixture installation, inspect unit. Remove paint splatters and other spots, dirt, and debris. Repair damaged finish to match original finish.
- B. Clean fixtures and other fittings with manufacturers' recommended cleaning methods and materials. Remove faucet spouts and strainers, remove sediment and debris, and reinstall strainers and spouts. Remove sediment and debris from drains.
- C. Clean fixtures, on completion of installation, according to manufacturer's written instructions.

### 3.9 PROTECTION

- A. Provide protective covering for installed fixtures and fittings.
- B. Do not allow use of fixtures for temporary facilities unless allowed in Division 1.

END OF SECTION 224000

SECTION 230500 – COMMON WORK RESULTS FOR MECHANICAL

PART 1 - GENERAL

1.1 RELATED DOCUMENTS

- A. Drawings and general provisions of the Contract, including General and Supplementary Conditions and Division 1 Specification Sections, apply to this Section.
- B. This section applies to Division 21, 22, & 23 sections.

1.2 GENERAL

- A. This Section includes mechanical items common to all of this division specification sections.
- B. Provide services, skilled and common labor, and all apparatus and materials required for the complete installation as shown and within the intent of the contract documents, field conditions, and code requirements.
- C. The intention of these Contract Documents is to call for finished work, fully tested and ready for operation. Any components or labor not mentioned in the Contract Documents but required for functioning systems shall be provided. Should there appear to be any discrepancies or questions of intent, the Contractor shall refer the matter to the Architect/Engineer for decision before start of any related work.
- D. The drawings show the general arrangement of systems and equipment but do not show all required fittings and offsets that may be necessary to connect pipes and ductwork to equipment, and to coordinate with other trades. Provide all necessary fittings, offsets and runs based on field measurements and at no additional cost. Coordinate with other trades for space available and relative location of equipment and accessories. Pipe and duct location on the drawings shall be altered by contractor where necessary to avoid interferences and clearance difficulties.
- E. This contractor will be responsible to carry out the commissioning requirements specified. Refer to Division 1 for additional requirements.

1.3 DEFINITIONS

- A. "Furnish": Supply and deliver to Project site, ready for unloading, unpacking, assembly, installation, and similar operations.
- B. "Provide": Operations at Project site including unloading, temporarily storing, unpacking, assembling, erecting, placing, anchoring, applying, working to dimension, finishing, curing, protecting, cleaning, and similar operations.
- C. "Provide": Furnish and install, complete and ready for the intended use.

- D. "Shall": The word shall is used to indicate mandatory requirements strictly to be followed in order to conform to the standard and procedures and from which no deviation is permitted.
- E. Finished Spaces: Spaces other than mechanical and electrical equipment rooms, furred spaces, pipe and duct shafts, unheated spaces immediately below roof, spaces above ceilings, unexcavated spaces, crawlspaces, and attics.
- F. Exposed, Interior Installations: Exposed to view indoors. Examples include finished occupied spaces and mechanical equipment rooms.
- G. Exposed, Exterior Installations: Exposed to view outdoors or subject to outdoor ambient temperatures and weather conditions. Examples include rooftop locations.
- H. Concealed, Interior Installations: Concealed from view and protected from physical contact by building occupants. Examples include above ceilings and in duct shafts.
- I. Concealed, Exterior Installations: Concealed from view and protected from weather conditions and physical contact by building occupants but subject to outdoor ambient temperatures. Examples include installations within unheated shelters.
- J. Terminal: A point where the controlled medium, such as fluid or energy, enters or leaves the distribution system.

#### 1.4 SUBMITTALS

- A. Provide in accordance with Division 1 of the specifications.

#### 1.5 SUBSTITUTIONS

- A. Provide in accordance with Division 1 of the specifications.

#### 1.6 QUALITY ASSURANCE

- A. All work, materials, and equipment shall comply with the rules and regulations of all codes and ordinances of the local, state, and federal authorities. Such codes, when more restrictive, shall take precedence over these plans and specifications.
- B. Multiple Units: When two or more units of materials or equipment of the same type or class are required, these units shall be products of one manufacturer.
- C. Steel Support Welding: Qualify processes and operators according to AWS D1.1, "Structural Welding Code--Steel."
- D. Electrical Characteristics for Equipment: Equipment of higher electrical characteristics may be furnished provided such proposed equipment is approved in writing and connecting electrical services, circuit breakers, and conduit sizes are appropriately modified. If minimum energy ratings or efficiencies are specified, equipment shall comply with requirements.

- E. The Contractor shall hold a license to perform the work as issued by the local jurisdiction.
- F. Plumbing work shall be performed by, or under, the direct supervision of a licensed master plumber.
- G. Electrical work shall be performed by, or under, the direct supervision of a licensed electrician.
- H. Compatibility of Options: If Contractor is given option of selecting between two or more products for use on Project, product selected shall be compatible with products previously selected, even if previously selected products were also options.
  - 1. Each contractor is responsible for providing products and construction methods compatible with products and construction methods of other contractors.
  - 2. If a dispute arises between contractors over concurrently selectable but incompatible products, Engineer will determine which products shall be used.

#### 1.7 PRODUCT DELIVERY, STORAGE, AND HANDLING

- A. Provide in accordance with Division 1.
- B. Piping:
  - 1. Pipe and tube required by the applicable standard to be cleaned and capped shall be delivered to the job site with factory-applied end-caps. Maintain end-caps through shipping, storage, and handling to prevent pipe-end damage and prevent entrance of dirt, debris, and moisture.
  - 2. Protect stored pipe and tube from moisture and dirt. Elevate above grade. When stored inside, do not exceed the structural capacity of the floor.
  - 3. Protect fittings, flanges, and piping specialties from moisture and dirt.
  - 4. Store plastic pipes protected from direct sunlight. Support to prevent sagging and bending.

#### 1.8 COORDINATION

- A. Coordinate use of project space and sequence of installation of mechanical and electrical work, which is indicated diagrammatically on drawings. Follow routings shown for pipes, ducts, and conduits as closely as practicable, with due allowance for available physical space; make runs parallel with lines of building. Utilize space efficiently to maximize accessibility for other installations, for maintenance, and for repairs.
- B. Coordinate use of project space and sequence of installation of work.
- C. Arrange for pipe spaces, chases, slots, and openings in building structure during progress of construction, to allow for installations.
- D. Access panels shall be provided for concealed valves and controls, or any item requiring inspection or maintenance. Access panels shall be of sufficient size and located so that the

concealed items may be serviced, maintained, or replaced. Access panels and doors are specified in Division 8.

## 1.9 RENOVATION PROJECTS

- A. Project Conditions: Full Owner Occupancy: The Owner intends to occupy the project site during construction. The Contractor shall cooperate with the Owner to minimize conflicts with the Owner's operations.
- B. The Contractor shall study all drawings and specifications, visit the site, and get acquainted with the existing conditions and the requirements of the plans and specifications. No claim will be recognized for extra compensation due to the failure of the Contractor to be familiarized with the conditions and extent of the proposed work. The Contractor shall execute all alterations, additions, removals, relocations or new work, etc., as indicated or required to provide a complete installation in accordance with the intent of the drawing and specifications.
- C. Use of Site: Limit use of premises to work in areas indicated. Do not disturb portions of site beyond areas in which the Work is indicated.
- D. Driveways and Entrances: Keep driveways and entrances serving premises clear and available to Owner, Owner's employees, and emergency vehicles at all times. Do not use these areas for parking or storage of materials. Schedule deliveries to minimize use of driveways and entrances. Schedule deliveries to minimize space and time requirements for storage of materials and equipment on-site.
- E. Follow the recommended procedures of the SMACNA IAQ Guidelines for Occupied Buildings under Construction.
  - 1. Dust partitions and depressurization of the work are performed under Division 1.
  - 2. The return side of an HVAC system is, by definition, under negative pressure and thus capable of drawing in nearby construction dust and odor. When possible, the entire system shall be shut down during heavy construction or demolition. The system shall be isolated from the surrounding environment as much as possible (e.g., all tiles in place for a ceiling plenum, duct and air handler leaks repaired) to prevent induction of pollutants.
  - 3. Return system openings in (and immediately adjacent to) the construction area shall be sealed with plastic.
  - 4. When the system must remain operational during construction, temporary filters shall be added to return grilles. All filters must receive frequent periodic maintenance and be replaced at end of project.
  - 5. When the general system must remain operational, the heaviest work areas shall be dampered off or otherwise blocked if temporary imbalance of the return air system does not create a greater problem.
  - 6. The mechanical room shall not be used to store construction or waste materials.
  - 7. Diffusers, VAV boxes, and ducts may be adequately protected in most cases where the above measures are implemented. When the system is off for the duration of construction, diffusers shall also be sealed in plastic for further protection. Ducts, diffusers, and window units shall be inspected upon completion of the work for the amount of deposited particulate present and cleaned where needed. If significant dust deposits are observed in the system during construction, some particulate discharge can

be expected during start-up. When such a discharge is only minor, delaying re-occupancy long enough to clean up the dust may be sufficient. In more severe cases, installing temporary coarse filters on diffusers or cleaning the ducts may be necessary. The condition of the main filters shall be checked whenever visible particulates are discharged from the system.

- F. Continuity of Services: The building will be in use during construction operations. Maintain existing systems in operation within all rooms of building at all times. Refer to “General Conditions of the Contract for Construction” for temporary facilities for additional contract requirements. Schedules for various phases of contract work shall be coordinated with all other trades and with Owner’s Representative. Provide, as part of contract, temporary plumbing and mechanical and electrical connections and relocations as required to accomplish the above.
- G. Existing Utilities: Do not interrupt utilities serving facilities occupied by Owner or others unless permitted under the following conditions and then only after arranging to provide temporary utility services. Notify Owner at least two days in advance of proposed utility interruptions. Identify extent and duration of utility interruptions. Indicate method of providing temporary utilities. Do not proceed with utility interruptions without Owner's written permission.

## PART 2 - PRODUCT

### 2.1 PRODUCT CRITERIA

- A. Standard Products: Material and equipment shall be the standard products of a manufacturer regularly engaged in the manufacture of the products for at least 3 years. See other specification sections for any exceptions.
- B. Equipment Service: Products shall be supported by a service organization that maintains a complete inventory of repair parts and is located reasonably close to the site.
- C. Multiple Units: When two or more units of materials or equipment of the same type or class are required, these units shall be products of one manufacturer.
- D. Assembled Units: Manufacturers of equipment assemblies, which use components made by others, assume complete responsibility for the final assembled product.
- E. Nameplates: Nameplate bearing manufacturer's name or identifiable trademark shall be securely affixed in a conspicuous place on equipment, or name or trademark cast integrally with equipment, stamped or otherwise permanently marked on each item of equipment.

### 2.2 PIPE JOINING MATERIALS

- A. Refer to individual Division 22 and 23 piping Sections for pipe, tube, and fitting materials and joining methods. Refer to individual piping Sections for special joining materials not listed below.

- B. Pipe Threads: ASME B1.20.1 for factory-threaded pipe and pipe fittings.
- C. Pipe-Flange Gasket Materials: Suitable for chemical and thermal conditions of piping system contents.
  - 1. ASME B16.21, nonmetallic, flat, asbestos-free, 1/8-inch maximum thickness unless thickness or specific material is indicated. Full-Face Type: For flat-face, Class 125, cast-iron and cast-bronze flanges. Narrow-Face Type: For raised-face, Class 250, cast-iron and steel flanges.
  - 2. AWWA C110, rubber, flat face, 1/8 inch thick, unless otherwise indicated; and full-face or ring type, unless otherwise indicated.
- D. Flange Bolts and Nuts: ASME B18.2.1, carbon steel, unless otherwise indicated.
- E. Mechanical Coupling Gasket Materials: Suitable for the chemical and thermal conditions of the piping system contents and exterior environment. Gasket design shall be such that the entire coupling housing is isolated from the system contents to prevent galvanic action and inhibit galvanic corrosion.
- F. Plastic, Pipe-Flange Gasket, Bolts, and Nuts: Type and material recommended by piping system manufacturer, unless otherwise indicated.
- G. Solder Filler Metals: ASTM B 32, lead-free alloys. Include water-flushable flux according to ASTM B 813.
- H. Brazing Filler Metals: AWS A5.8, BCuP Series, copper-phosphorus alloys for general-duty brazing, unless otherwise indicated; and AWS A5.8, BAgl, silver alloy for refrigerant piping, unless otherwise indicated.
- I. Welding Filler Metals: Comply with AWS D10.12 for welding materials appropriate for wall thickness and chemical analysis of steel pipe being welded.
- J. Solvent Cements for Joining Plastic Piping: CPVC Piping: ASTM F 493. PVC Piping: ASTM D 2564. Include primer according to ASTM F 656.

### 2.3 TRANSITION FITTINGS

- A. AWWA Transition Couplings: Same size as, and with pressure rating at least equal to and with ends compatible with, piping to be joined. Underground Piping NPS 1-1/2 and Smaller: Manufactured fitting or coupling. Underground Piping NPS 2 and Larger: AWWA C219, metal sleeve-type coupling. Aboveground Pressure Piping: Pipe fitting.
- B. Plastic-to-Metal Transition Fittings: one-piece fitting with manufacturer's Schedule 80 equivalent dimensions; one end with threaded brass insert, and one solvent-cement-joint end.
- C. Flexible Transition Couplings for Underground Non-pressure Drainage Piping: ASTM C 1173 with elastomeric sleeve; ends same size as piping to be joined, and corrosion-resistant metal band on each end.

## 2.4 DIELECTRIC FITTINGS

- A. Provide where copper tubing and ferrous metal pipe are joined.
- B. Fittings shall match piping specifications. Threaded dielectric union, ANSI B16.39. Watts Series LF3000 (lead free) or approved equal. Flange union with dielectric gasket and bolt sleeves, ANSI B16.42. Dielectric flange fittings: Watts Series LF3100.

## 2.5 SLEEVES

- A. Cast-Iron Wall Pipes: Cast or fabricated of cast or ductile iron and equivalent to ductile-iron pressure pipe, with plain ends and integral waterstop unless otherwise indicated.
- B. Galvanized-Steel Wall Pipes: ASTM A 53/A 53M, Schedule 40, with plain ends and welded steel collar; zinc coated.
- C. Galvanized-Steel-Pipe Sleeves: ASTM A 53/A 53M, Type E, Grade B, Schedule 40, zinc coated, with plain ends.
- D. Molded-PE or -PP Sleeves: Removable, tapered-cup shaped, and smooth outer surface with nailing flange for attaching to wooden forms.

## 2.6 ESCUTCHEONS

- A. Escutcheons shall be manufactured from nonferrous metals and shall be chrome-plated. Metals and finish shall conform to ASME A112.19.2. Escutcheons shall be one-piece type where mounted on chrome-plated pipe or tubing, and one-piece of split-pattern type elsewhere. ID shall closely fit around pipe, tube, and insulation of insulated piping and an OD that completely cover the opening.
- B. All escutcheons shall have setscrews for maintaining a fixed position against a surface.

## 2.7 GROUT

- A. Description: ASTM C 1107, Grade B, non-shrink and nonmetallic, dry hydraulic-cement grout. Characteristics: Post-hardening, volume adjusting, non-staining, non-corrosive, nongaseous, and recommended for interior and exterior applications. Design Mix: 5000-psi, 28-day compressive strength. Packaging: Premixed and factory packaged.

## 2.8 ROOFING

- A. Coordinate roofing with Division 7.

## 2.9 VIBRATION ISOLATION

- A. All equipment shall be isolated to prevent vibration transmission to the building structure.



## PART 3 - EXECUTION

## 3.1 DEMOLITION AND REMOVALS

- A. Refer to Division 1 for general demolition requirements and procedures.
- B. Disconnect, demolish, and remove plumbing and mechanical systems, equipment, and components indicated to be removed.
- C. If pipe, insulation, or equipment to remain is damaged in appearance or is unserviceable, remove damaged or unserviceable portions and replace with new products of equal capacity and quality.

## 3.2 COMMON REQUIREMENTS

- A. Provide piping, ductwork, and equipment to allow maximum possible headroom unless specific mounting heights are indicated. Provide equipment level and plumb, parallel and perpendicular to other building systems and components in exposed interior spaces, unless otherwise indicated.
- B. Provide equipment to facilitate service, maintenance, and repair or replacement of components. Connect equipment for ease of disconnecting, with minimum interference to other installations. Extend grease fittings to accessible locations.
- C. Coordinate location of piping, sleeves, inserts, hangers, ductwork and equipment. Locate piping, sleeves, inserts, hangers, ductwork and equipment clear of windows, doors, openings, light outlets, and other services and utilities. Follow manufacturer's published recommendations for installation methods not otherwise specified.
- D. Any structural member weakened or impaired by cutting, notching, or otherwise shall be reinforced, repaired, or replaced so as to be left in safe structural condition in accordance with the local building code requirements.
- E. Provide piping and ductwork in concealed locations, unless otherwise indicated and except in equipment rooms and service areas.
- F. Provide piping indicated to be exposed and piping in equipment rooms and service areas at right angles or parallel to building walls. Diagonal runs are prohibited unless specifically indicated otherwise.
- G. Provide systems above accessible ceilings to allow sufficient space for ceiling panel removal.
- H. Provide piping to permit valve servicing.
- I. Provide equipment and other components to allow right of way for piping installed at required slope.
- J. Provide free of sags and bends.

- K. Provide unions or flanges at connections to equipment.
- L. Provide fittings for changes in direction and branch connections.
- M. Make allowances for application of insulation.
- N. Select system components with pressure rating equal to or greater than system operating pressure.
- O. Verify final equipment locations for roughing-in.
- P. Protection and Cleaning: Equipment and materials shall be carefully handled, properly stored, and adequately protected to prevent damage before and during installation, in accordance with the manufacturer's recommendations. Damaged or defective items shall be replaced. Protect all finished parts of equipment. Close duct and pipe openings with caps or plugs during installation. Tightly cover and protect fixtures and equipment against dirt, water, chemical, or mechanical injury. At completion of all work thoroughly clean fixtures, exposed materials and equipment.

### 3.3 PIPING JOINT CONSTRUCTION

- A. Join pipe and fittings according to the following requirements and the relevant specification section specifying piping systems.
- B. Ream ends of pipes and tubes and remove burrs. Bevel or groove plain ends of steel pipe.
- C. Remove scale, slag, dirt, and debris from inside and outside of pipe and fittings before assembly.
- D. Soldered Joints: Apply ASTM B 813, water-flushable flux, unless otherwise indicated, to tube end. Construct joints according to ASTM B 828 or CDA's "Copper Tube Handbook," using lead-free solder alloy complying with ASTM B 32.
- E. Brazed Joints: Construct joints according to AWS's "Brazing Handbook," "Pipe and Tube" Chapter, using copper-phosphorus brazing filler metal complying with AWS A5.8. Only brazing alloys having a liquid temperature above 1000°F shall be used.
- F. Threaded Joints: Thread pipe with tapered pipe threads according to ASME B1.20.1. Cut threads full and clean using sharp dies. Ream threaded pipe ends to remove burrs and restore full ID. Join pipe fittings and valves as follows: Apply appropriate tape or thread compound to external pipe threads unless dry seal threading is specified. Damaged Threads: Do not use pipe or pipe fittings with threads that are corroded or damaged. Do not use pipe sections that have cracked or open welds.
- G. Welded Joints: Construct joints according to AWS D10.12, using qualified processes and welding operators according to Part 1 "Quality Assurance" Article.
- H. Flanged Joints: Select appropriate gasket material, size, type, and thickness for service application. Provide gasket concentrically positioned. Use suitable lubricants on bolt threads.

- I. Plastic Piping Solvent-Cement Joints: Clean and dry joining surfaces. Join pipe and fittings according to the following:
  - 1. Comply with ASTM F 402 for safe-handling practice of cleaners, primers, and solvent cements.
  - 2. CPVC Piping: Join according to ASTM D 2846/D 2846M Appendix.
  - 3. PVC Pressure Piping: Join schedule number ASTM D 1785, PVC pipe and PVC socket fittings according to ASTM D 2672. Join other-than-schedule-number PVC pipe and socket fittings according to ASTM D 2855.
  - 4. PVC Non-pressure Piping: Join according to ASTM D 2855.
- J. Plastic Pressure Piping Gasketed Joints: Join according to ASTM D 3139.
- K. Plastic Non-pressure Piping Gasketed Joints: Join according to ASTM D 3212.

### 3.4 PIPE PENETRATIONS & SLEEVES

- A. Provide sealants for all pipe penetrations. All pipe penetrations shall be sealed.
- B. Refer to Section 230700 "Mechanical Insulation".
- C. Sleeve Clearance: Sleeve through floors, walls, partitions, and beams shall be one inch greater in diameter than external diameter of pipe. Sleeve for pipe with insulation shall be large enough to accommodate the insulation.
- D. Provide sleeves for pipes passing through concrete and masonry construction. Galvanized-Steel Sheet: 0.0239-inch minimum thickness; round tube closed with welded longitudinal joint. Cut sleeves to length for mounting flush with both surfaces. Provide sleeves in new walls and slabs as new walls and slabs are constructed. Provide steel pipe sleeves that are large enough to provide 1/4-inch annular clear space between sleeve and pipe or pipe insulation. Piping through concrete or masonry shall not be subject to any load from the building construction.
  - 1. Sleeves are not required in drywall construction.
  - 2. Sleeves are not required for core-drilled holes.
- E. Fire-Barrier Penetrations: Maintain indicated fire rating of walls, partitions, ceilings, and floors at pipe penetrations. Seal pipe penetrations with firestop materials. Comply with requirements for firestopping specified in Division 7.
- F. Escutcheons: Provide for penetrations in finished spaces where pipes are exposed.
- G. Plastic and copper piping penetrating framing members, and within one-inch of the framing, shall be protected with 10-gauge steel nailing plates. The steel plate shall extend along the framing member a minimum of 1.5" beyond the OD of the pipe or tubing.

### 3.5 PIPING CONNECTIONS

- A. Make connections according to the following, unless otherwise indicated: Provide unions, in piping NPS 2 and smaller, adjacent to each valve and at final connection to each piece of equipment. Provide flanges in piping NPS 2-1/2 and larger, adjacent to valves and at final connection to each piece of equipment.
- B. Provide dielectric fittings at connection between copper and ferrous metal.

### 3.6 ERECTION OF WOOD SUPPORTS AND ANCHORAGES

- A. Cut, fit, and place wood grounds, nailers, blocking, and anchorages to support, and anchor materials and equipment.
- B. Select fastener sizes that will not penetrate members if opposite side will be exposed to view or will receive finish materials. Tighten connections between members. Provide fasteners without splitting wood members.
- C. Attach to substrates as required to support applied loads.

### 3.7 GROUTING

- A. Provide in accordance with Division 3.

### 3.8 ERECTION OF METAL SUPPORTS AND ANCHORAGES

- A. Provide in accordance with Division 5.

### 3.9 FIRESTOPPING

- A. Provide through-penetration firestop systems. Refer to Division 7 for materials. Seal penetrations through fire-or smoke-rated wall, partition, ceiling, or roof assemblies with firestopping systems. Refer to Architectural plans for location of rated assemblies.

### 3.10 ROOFING

- A. Refer to Division 7.
- B. Coordinate installation of roof curbs, equipment supports, and roof penetrations.

### 3.11 PROJECT CLOSEOUT

- A. Provide Demonstration and Training in accordance Division 1.
- B. Provide Project Record Documents in accordance with Division 1.

- C. Follow Closeout procedures as per Division 1.
- D. Provide Operation and Maintenance information in accordance with Division 1.

END OF SECTION 230500

## SECTION 230553 – IDENTIFICATION FOR MECHANICAL

### PART 1 - GENERAL

#### 1.1 RELATED DOCUMENTS

- A. Drawings and general provisions of the Contract, including General and Supplementary Conditions and Division 1 Specification Sections, apply to this Section.
- B. Division 23 Section "Common Work Results for Mechanical"

#### 1.2 SUMMARY

- A. This Section includes the following mechanical identification materials and their installation.

#### 1.3 SUBMITTALS

- A. Product Data: For each type of product indicated.

#### 1.4 QUALITY ASSURANCE

- A. ASME Compliance: Comply with ASME A13.1, "Scheme for the Identification of Piping Systems," for letter size, length of color field, colors, and viewing angles of identification devices for piping.

#### 1.5 COORDINATION

- A. Coordinate installation of identifying devices with completion of covering and painting of surfaces where devices are to be applied.
- B. Coordinate installation of identifying devices with location of access panels and doors.
- C. Provide identifying devices before installing acoustical ceilings and similar concealment.

### PART 2 - PRODUCTS

#### 2.1 EQUIPMENT IDENTIFICATION DEVICES

- A. Terminology: Match schedules as closely as possible.
- B. Tag and description: Example: "VAV-1"

- C. Equipment Markers: neatly lettered using a Sharpie permanent marker.
- D. In addition to the equipment tag, equipment located above the ceiling that requires servicing shall be labeled on the ceiling grid using a labeling machine.

## 2.2 PIPING IDENTIFICATION DEVICES

- A. Manufactured Pipe Markers, General: Seton, Brady, or approved equal; preprinted, color-coded, with lettering indicating service, and showing direction of flow.
  - 1. Colors: Comply with ASME A13.1, unless otherwise indicated.
  - 2. Lettering: Use piping system terms indicated and abbreviate only as necessary for each application length. Size of letters and length of color field per ASME A13.1.
  - 3. Pipes with OD, Including Insulation; Full-band snap-around pipe markers extending 360 degrees around pipe at each location.
  - 4. Arrows: Integral with piping system service lettering to accommodate both directions; or as separate unit on each pipe marker to indicate direction of flow.
  - 5. Minimum length of color field and size of letters shall be in accordance with Uniform Plumbing Code requirements.

## PART 3 - EXECUTION

### 3.1 APPLICATIONS, GENERAL

- A. Products specified are for applications referenced in other Division 22 or 23 Sections. If more than single-type material, device, or label is specified for listed applications, selection is Installer's option.

### 3.2 EQUIPMENT IDENTIFICATION

- A. Provide equipment markers on each item of scheduled equipment. Data required for markers may be included on signs, and markers may be omitted if both are indicated.
  - 1. Letter Size: Minimum 1/4 inch for name of units if viewing distance is less than 24 inches, 1/2 inch for viewing distances up to 72 inches, and proportionately larger lettering for greater viewing distances. Include secondary lettering two-thirds to three-fourths the size of principal lettering.
  - 2. Data: Distinguish among multiple units, indicate operational requirements, indicate safety and emergency precautions, warn of hazards and improper operations, and identify units.
  - 3. Locate markers where accessible and visible.

- B. Equipment located above the ceiling that requires servicing shall be labeled on the ceiling using a labeling machine. Letters shall be ¼" high, black.
  - 1. Label all equipment above ceiling that requires servicing or access, including shutoff valves and VAV boxes.
  - 2. Locate labels on the ceiling grid, adjacent to the ceiling tile that provides the best access to the valve or item that requires servicing.

### 3.3 PIPING IDENTIFICATION

- A. Provide manufactured pipe markers indicating service on each piping system.
  - 1. Provide pipe markers to manufacturer's instructions.
  - 2. Identify piping, concealed or exposed. Include service and flow direction.
  - 3. Provide in clear view and align with axis of piping.
  - 4. Locate identification at maximum 20 feet centers on straight runs including risers and drops, adjacent to each valve and tee, at each side of penetration of structure or enclosure, and at each obstruction.
  - 5. At access doors and similar access points that permit view of concealed piping.
  - 6. At least one per room.
- B. Unions covered by insulation: Stencil or label the outside insulation jacket of each union with the word "union." Match size and color of pipe labels.

### 3.4 ADJUSTING

- A. Relocate mechanical identification materials and devices that have become visually blocked by other work.

### 3.5 CLEANING

- A. Clean faces of mechanical identification devices.

END OF SECTION 230553





SECTION 230593 - TESTING, ADJUSTING, AND BALANCING FOR HVAC

PART 1 - GENERAL

1.1 RELATED DOCUMENTS

- A. Drawings and general provisions of the Contract, including General and Supplementary Conditions and Division 01 Specification Sections, apply to this Section.

1.2 SUMMARY

- A. Section Includes Testing, Adjusting, & Balancing

1.3 ACTION SUBMITTALS

- A. Use standard forms from AABC's "National Standards for Testing and Balancing Heating, Ventilating, and Air Conditioning Systems." NEBB's "Procedural Standards for Testing, Adjusting, and Balancing of Environmental Systems." SMACNA's TABB "HVAC Systems - Testing, Adjusting, and Balancing." TAB firm's forms approved by Architect. TABB "Contractors Certification Manual."

1.4 QUALITY ASSURANCE

- A. Instrumentation Type, Quantity, Accuracy, and Calibration: Comply with requirements in ASHRAE 111, Section 4, "Instrumentation."
- B. ASHRAE Compliance: Applicable requirements in ASHRAE 62.1, Section 7.2.2 - "Air Balancing."
- C. ASHRAE/IESNA Compliance: Applicable requirements in ASHRAE/IESNA 90.1, Section 6.7.2.3 - "System Balancing."

PART 2 - PRODUCTS (Not Applicable)

PART 3 - EXECUTION

3.1 EXAMINATION

- A. Examine the Contract Documents to become familiar with Project requirements and to discover conditions in systems designs that may preclude proper TAB of systems and equipment.
- B. Examine the approved submittals for HVAC systems and equipment.

- C. Examine design data including HVAC system descriptions, statements of design assumptions for environmental conditions and systems output, and statements of philosophies and assumptions about HVAC system and equipment controls.
- D. Examine equipment performance data. Relate performance data to Project conditions and requirements, including system effects that can create undesired or unpredicted conditions that cause reduced capacities in all or part of a system. Calculate system-effect factors to reduce performance ratings of HVAC equipment when installed under conditions different from the conditions used to rate equipment performance.
- E. Examine system and equipment installations and verify that field quality-control testing, cleaning, and adjusting specified in individual Sections have been performed.
- F. Examine test reports specified in individual system and equipment Sections.
- G. Examine HVAC equipment and verify that equipment is installed per manufacturers recommendations with functioning controls and ready for operation.
- H. Hydronic Systems: Examine strainers. Verify that startup screens have been replaced by permanent screens with indicated perforations. Examine control valves for proper installation for their intended function of throttling, diverting, or mixing fluid flows. Examine heat-transfer coils for correct piping connections and for clean and straight fins. Examine system pumps to ensure absence of entrained air in the suction piping.
- I. Examine operating safety interlocks and controls on HVAC equipment.
- J. Report deficiencies discovered before and during performance of TAB procedures. Observe and record system reactions to changes in conditions. Record default set points if different from indicated values.

### 3.2 PREPARATION

- A. Prepare a TAB plan that includes the following:
  - 1. Equipment and systems to be tested.
  - 2. Strategies and step-by-step procedures for balancing the systems.
  - 3. Instrumentation to be used.
  - 4. Sample forms with specific identification for all equipment.
- B. Perform system-readiness checks of HVAC systems and equipment to verify system readiness for TAB work. Include, at a minimum, the following:
  - 1. Airside:
    - a. Verify that leakage and pressure tests on air distribution systems have been satisfactorily completed.
    - b. Duct systems are complete with terminals installed.
    - c. Dampers are open and functional.
    - d. Clean filters are installed.

- e. Fans are operating, free of vibration, and rotating in correct direction.
- f. Variable-frequency controllers' startup is complete and safeties are verified.
- g. Automatic temperature-control systems are operational.
- h. Ceilings are installed.
- i. Windows and doors are installed.
- j. Suitable access to balancing devices and equipment is provided.

### 3.3 GENERAL PROCEDURES FOR TESTING AND BALANCING

- A. Perform testing and balancing procedures on each system according to the procedures contained in AABC's "National Standards for Total System Balance", ASHRAE 111 or SMACNA's "HVAC Systems - Testing, Adjusting, and Balancing" and in this Section.
- B. Cut insulation, ducts, pipes, and equipment cabinets for installation of test probes to the minimum extent necessary for TAB procedures. After testing and balancing, patch probe holes in ducts with same material and thickness as used to construct ducts. Install and join new insulation that matches removed materials. Restore insulation, coverings, vapor barrier, and finish according to the mechanical insulation specification.
- C. Mark equipment and balancing devices, including damper-control positions, valve position indicators, VFD's, and similar controls and devices, with paint or other suitable, permanent identification material to show final settings.
- D. Take and report testing and balancing measurements in inch-pound (IP) units.

### 3.4 GENERAL PROCEDURES FOR BALANCING AIR SYSTEMS

- A. Prepare test reports for both fans and outlets. Obtain manufacturer's outlet factors and recommended testing procedures. Cross-check the summation of required outlet volumes with required fan volumes.
- B. Determine the best locations in main and branch ducts for accurate duct-airflow measurements.
- C. Check dampers for proper position to achieve desired airflow path.
- D. Check for airflow blockages.

### 3.5 PROCEDURES FOR CONSTANT-VOLUME AIR SYSTEMS

- A. Adjust fans to deliver total indicated airflows within the maximum allowable fan speed listed by fan manufacturer.
  - 1. Measure total airflow.
    - a. Where duct conditions allow, measure airflow by Pitot-tube traverse. If necessary, perform multiple Pitot-tube traverses to obtain total airflow.

- b. Where duct conditions are not suitable for Pitot-tube traverse measurements, a coil traverse may be acceptable.
    - c. If a reliable Pitot-tube traverse or coil traverse is not possible, measure airflow at terminals and calculate the total airflow.
  2. Measure fan static pressures as follows:
    - a. Measure static pressure directly at the fan outlet or through the flexible connection.
    - b. Measure static pressure directly at the fan inlet or through the flexible connection.
    - c. Measure static pressure across each component that makes up the air-handling system.
    - d. Report artificial loading of filters at the time static pressures are measured.
  3. Review Record Documents to determine variations in design static pressures versus actual static pressures. Calculate actual system-effect factors. Recommend adjustments to accommodate actual conditions.
  4. Do not make fan-speed adjustments that result in motor overload. Consult equipment manufacturers about fan-speed safety factors. Modulate dampers and measure fan-motor amperage to ensure that no overload occurs. Measure amperage all operating modes to determine the maximum required brake horsepower.
- B. Adjust volume dampers for main duct, submain ducts, and major branch ducts to indicated airflows.
  1. Measure airflow of submain and branch ducts.
  2. Adjust submain and branch duct volume dampers for specified airflow.
  3. Re-measure each submain and branch duct after all have been adjusted.
- C. Adjust air inlets and outlets for each space to indicated airflows.
  1. Set airflow patterns of adjustable outlets for proper distribution without drafts.
  2. Measure inlets and outlets airflow.
  3. Adjust each inlet and outlet for specified airflow.
  4. Re-measure each inlet and outlet after they have been adjusted.
- D. Verify final system conditions.
  1. Re-measure and confirm that total airflow is within design.
  2. Re-measure all final fan operating data, rpms, volts, amps, and static profile.
  3. Mark all final settings.
  4. Measure and record all operating data.
  5. Record final fan-performance data.

### 3.6 PROCEDURES FOR VARIABLE-AIR-VOLUME SYSTEMS

- A. Adjust the variable-air-volume systems as follows:
  1. Verify that the system is under static pressure control.

2. Select the terminal unit that is most critical to the supply-fan airflow. Measure inlet static pressure, and adjust system static pressure control set point so the entering static pressure for the critical terminal unit is not less than the sum of the terminal-unit manufacturer's recommended minimum inlet static pressure plus the static pressure needed to overcome terminal-unit discharge system losses.
3. Calibrate and balance each terminal unit for maximum and minimum design airflow as follows:
  - a. Adjust controls so that terminal is calling for maximum airflow. Some controllers require starting with minimum airflow. Verify calibration procedure for specific project.
  - b. Measure airflow and adjust calibration factor as required for design maximum airflow. Record calibration factor.
  - c. When maximum airflow is correct, balance the air outlets downstream from terminal units.
  - d. Adjust controls so that terminal is calling for minimum airflow.
  - e. Measure airflow and adjust calibration factor as required for design minimum airflow. Record calibration factor. If no minimum calibration is available, note any deviation from design airflow.
4. After terminals have been calibrated and balanced, test and adjust system for total airflow. Adjust fans to deliver total design airflows within the maximum allowable fan speed listed by fan manufacturer.
  - a. Set terminals for maximum airflow. If system design includes diversity, adjust terminals for maximum and minimum airflow so that connected total matches fan selection and simulates actual load in the building.
  - b. Where duct conditions allow, measure airflow by Pitot-tube traverse. If necessary, perform multiple Pitot-tube traverses to obtain total airflow.
  - c. Where duct conditions are not suitable for Pitot-tube traverse measurements, a coil traverse may be acceptable.
  - d. If a reliable Pitot-tube traverse or coil traverse is not possible, measure airflow at terminals and calculate the total airflow.
5. Measure fan static pressures as follows:
  - a. Measure static pressure directly at the fan outlet or through the flexible connection.
  - b. Measure static pressure directly at the fan inlet or through the flexible connection.
  - c. Measure static pressure across each component that makes up the air-handling system.
  - d. Report any artificial loading of filters at the time static pressures are measured.
6. Re-measure the inlet static pressure at the most critical terminal unit and adjust the system static pressure set point to the most energy-efficient set point to maintain the optimum system static pressure. Record set point and give to controls contractor.



### 3.7 PROCEDURES FOR MOTORS

- A. Motors 1/2 HP and Larger: Test at final balanced conditions and record the following data:
  - 1. Manufacturer's name, model number, and serial number.
  - 2. Motor horsepower rating.
  - 3. Motor rpm.
  - 4. Phase and hertz.
  - 5. Nameplate and measured voltage, each phase.
  - 6. Nameplate and measured amperage, each phase.
  - 7. Starter size and thermal-protection-element rating.
  - 8. Service factor and frame size.
  
- B. Motors Driven by Variable-Frequency Controllers: Test manual bypass of controller to prove proper operation.

### 3.8 PROCEDURES FOR HEAT-TRANSFER COILS

- A. Measure, adjust, and record the following data for each electric heating coil:
  - 1. Nameplate data.
  - 2. Airflow.
  - 3. Entering- and leaving-air temperature at full load.
  - 4. Voltage and amperage input of each phase at full load.
  - 5. Calculated kilowatt at full load.
  - 6. Fuse or circuit-breaker rating for overload protection.

### 3.9 CONTROLS VERIFICATION

- A. In conjunction with system balancing, perform the following:
  - 1. Verify temperature control system is operating within the design limitations.
  - 2. Confirm that the sequences of operation are in compliance with Contract Documents.
  - 3. Verify that controllers are calibrated and function as intended.
  - 4. Verify that controller set points are as indicated.
  - 5. Verify the operation of valve and damper actuators.
  - 6. Verify that controlled devices are properly installed and connected to correct controller.
  - 7. Verify that controlled devices travel freely and are in position indicated by controller: open, closed, or modulating.
  - 8. Verify location and installation of sensors to ensure that they sense only intended temperature, humidity, or pressure.
  
- B. Reporting: Include a summary of verifications performed, remaining deficiencies, and variations from indicated conditions.



## 3.10 PROCEDURES FOR DOMESTIC HOT WATER RECIRCULATION SYSTEMS

- A. Prepare test reports with pertinent design data and number in sequence starting at pump to end of system.
- B. System Diagrams: Include schematic layouts of as-built domestic hot water systems. Present each system with single-line diagram and include the following:
  - 1. Water flow rates.
  - 2. Pipe and valve sizes and locations.
  - 3. Recirculation valve settings/flows
- C. Balancing shall include the following minimum data:
  - 1. Pump flow
  - 2. Balancing valve flows: proportionally balance flow to each recirculation loop.
- D. Pumps:
  - 1. Adjust balancing valves at pumps to obtain design water flow. Record pressure rise across pumps and GPM flow from pump curve. Permanently mark the balanced position for each valve. (Note: If discharge valves on the pumps are used for balancing, record the head being restricted by the valves).
  - 2. Do not deadhead the pumps. Check pump-motor load. If motor is overloaded, throttle main flow-balancing device so motor nameplate rating is not exceeded. Running amps and brake horsepower of pump motor under full flow and no flow conditions.
  - 3. Calculate impeller size by plotting the shutoff head on pump curves and include the following pump test report data:
  - 4. Unit Data:
    - a. Unit identification.
    - b. Location.
    - c. Service.
    - d. Make and size.
    - e. Model and serial numbers.
    - f. Water flow rate in gpm.
    - g. Water pressure differential in feet of head or psig.
    - h. Pump rpm.
    - i. Impeller diameter in inches.
    - j. Seal type.
    - k. Motor Data: as specified herein before.
  - 5. Test Data (Indicated and Actual Values):
    - a. Static head in feet of head or psig.
    - b. Pump shutoff pressure in feet of head or psig.
    - c. Actual impeller size in inches.
    - d. Full-open flow rate in gpm.
    - e. Full-open pressure in feet of head or psig.
    - f. Final discharge pressure in feet of head or psig.

- g. Final suction pressure in feet of head or psig.
- h. Final total pressure in feet of head or psig.
- i. Final water flow rate in gpm.
- j. Voltage at each connection.

### 3.11 TOLERANCES

A. Set HVAC system's airflow rates and water flow rates within the following tolerances:

- 1. Fans: Plus or minus 10 percent.
- 2. Air Outlets and Inlets: Plus or minus 10 percent.

### 3.12 FINAL REPORT

A. General: Prepare a certified written report; tabulate and divide the report into separate sections for tested systems and balanced systems.

- 1. Include a certification sheet at the front of the report's binder, signed and sealed by the certified testing and balancing engineer.
- 2. Include a list of instruments used for procedures, along with proof of calibration.
- 3. Certify validity and accuracy of field data.

B. Final Report Contents: In addition to certified field-report data, include the following:

- 1. Flow curves.
- 2. Manufacturers' test data.
- 3. Field test reports prepared by system and equipment installers.
- 4. Other information relative to equipment performance; do not include Shop Drawings and Product Data.

C. General Report Data: In addition to form titles and entries, include the following data:

- 1. Title page.
- 2. Name and address of the TAB specialist.
- 3. Project name.
- 4. Project location.
- 5. Architect's name and address.
- 6. Engineer's name and address.
- 7. Contractor's name and address.
- 8. Report date.
- 9. Signature of TAB supervisor who certifies the report.
- 10. Table of Contents with the total number of pages defined for each section of the report. Number each page in the report.
- 11. Summary of contents including the following:
  - a. Indicated versus final performance.
  - b. Notable characteristics of systems.

- c. Description of system operation sequence if it varies from the Contract Documents.
  12. Nomenclature sheets for each item of equipment.
  13. Data for terminal units, including manufacturer's name, type, size, and fittings.
  14. Notes to explain why certain final data in the body of reports vary from indicated values.
- D. Fan Test Reports, include the following:
  1. Fan Data:
    - a. System identification.
    - b. Location.
    - c. Make and type.
    - d. Model number and size.
    - e. Manufacturer's serial number.
    - f. Arrangement and class.
  2. Motor Data:
    - a. Motor make, and frame type and size.
    - b. Horsepower and rpm.
    - c. Volts, phase, and hertz.
    - d. Full-load amperage and service factor.
  3. Test Data (Indicated and Actual Values):
    - a. Total airflow rate in cfm.
    - b. Total system static pressure in inches wg.
    - c. Fan rpm.
    - d. Discharge static pressure in inches wg.
    - e. Suction static pressure in inches wg.
- E. Duct Traverse Reports: Include a diagram with a grid representing the duct cross-section and record the following:
  1. Report Data:
    - a. System and air-handling-unit number.
    - b. Location and zone.
    - c. Traverse air temperature in deg F.
    - d. Duct static pressure in inches wg.
    - e. Duct size in inches.
    - f. Duct area in sq. ft.
    - g. Indicated airflow rate in cfm.
    - h. Indicated velocity in fpm.
    - i. Actual airflow rate in cfm.
    - j. Actual average velocity in fpm.

F. Air-Terminal-Device Reports:

1. Unit Data:
  - a. System and air-handling unit identification.
  - b. Location and zone.
  - c. Apparatus used for test.
  - d. Area served.
  - e. Make.
  - f. Number from system diagram.
  - g. Type and model number.
  - h. Size.
2. Test Data (Indicated and Actual Values):
  - a. Airflow rate in cfm.

G. Terminal Unit Coil Reports: For coils of terminal units, include the following:

1. Unit Data:
  - a. System and air-handling-unit identification.
  - b. Location and zone.
  - c. Room or riser served.
  - d. Coil make and size.
2. Test Data (Indicated and Actual Values):
  - a. Airflow rate in cfm.
  - b. Entering-water temperature in deg F.
  - c. Leaving-water temperature in deg F.
  - d. Water pressure drop in feet of head or psig.
3. Electric-Coil Test Reports: include the following:
  - a. Connected volts, phase, and hertz.
  - b. Rated amperage.
  - c. Face area in sq. ft.
  - d. Voltage at each connection.
  - e. Amperage for each phase.

H. Instrument Calibration Reports:

1. Report Data:
  - a. Instrument type and make.
  - b. Serial number.
  - c. Application.
  - d. Dates of use.
  - e. Dates of calibration.

3.13 VERIFICATION OF TAB REPORT

- A. Owner or Commissioning authority will randomly select measurements, documented in the final report, to be rechecked. Rechecking shall be limited to either 10 percent of the total measurements recorded or the extent of measurements that can be accomplished in a normal 8-hour business day.
- B. If rechecks yield measurements that differ from the measurements documented in the final report by more than the tolerances allowed, the measurements shall be noted as "FAILED."
- C. If the number of "FAILED" measurements is greater than 10 percent of the total measurements checked during the final inspection, the testing and balancing shall be considered incomplete and shall be rejected.
- D. If TAB work fails, proceed as follows:
  - 1. TAB specialists shall recheck all measurements and make adjustments. Revise the final report and balancing device settings to include all changes; resubmit the final report and request a second final inspection.
  - 2. If the second final inspection also fails, Owner may contract the services of another TAB specialist to complete TAB work according to the Contract Documents and deduct the cost of the services from the original TAB specialist's final payment.
- E. Prepare test and inspection reports.

END OF SECTION 230593



## SECTION – 230700 - MECHANICAL INSULATION

### PART 1 - GENERAL

#### 1.1 RELATED DOCUMENTS

- A. Drawings and general provisions of the Contract, including General and Supplementary Conditions and Division 1 Specification Sections, apply to this Section.
- B. Related Sections include the following:
  - 1. Division 7 for firestopping materials and requirements for penetrations through fire and smoke barriers.
  - 2. Division 23 Section "Common Work Results for Mechanical"
  - 3. Division 23 Section "Hangers and Supports for Piping and Equipment" for pipe insulation shields and protection saddles.
  - 4. Division 23 Section "Metal Ducts" for duct liner.

#### 1.2 SUMMARY

- A. This Section includes insulation and related components.

#### 1.3 ACTION SUBMITTALS

- A. Product Data: Identify thermal conductivity, Greenguard Certification, thickness, and jackets (both factory and field applied, if any), for each type of product indicated. For adhesives and sealants, provide documentation including printed a statement of VOC content.

#### 1.4 QUALITY ASSURANCE

- A. Installer Qualifications: Skilled mechanics who have successfully completed an apprenticeship program or another craft training program certified by the U.S. Department of Labor, Bureau of Apprenticeship and Training.
- B. Surface-Burning Characteristics: For insulation and related materials, as determined by testing identical products according to ASTM E 84, by a testing agency acceptable to authorities having jurisdiction. Factory label insulation and jacket materials and adhesive, mastic, tapes, and cement material containers, with appropriate markings of applicable testing agency.
- C. Insulation Installed Indoors: Flame-spread index of 25 or less, and smoke-developed index of 50 or less. Insulation Installed Outdoors: Flame-spread index of 75 or less, and smoke-developed index of 150 or less.

### 1.5 DELIVERY, STORAGE, AND HANDLING

- A. Ship insulation materials in containers marked by manufacturer with appropriate ASTM specification designation, type and grade, and maximum use temperature.
- B. All of the insulation materials and accessories covered by this specification shall be delivered to the job site and stored in a safe, dry place with appropriate labels and/or other product identification.
- C. Store tapes, adhesives, mastics, cements, and insulation materials in ambient conditions in accordance with the recommendations of the manufacturer.
- D. Follow manufacturer's recommended handling practices.
- E. The contractor shall use whatever means are necessary to protect the insulation materials and accessories before, during, and after installation. No insulation material shall be installed that has become damaged in any way. The contractor shall also use all means necessary to protect work and materials installed by other trades.
- F. Fiber Glass and Mold: Contractor shall take precaution to protect insulation. Any fiber glass insulation that becomes wet or torn should be replaced at no additional cost. Air handling insulation used in the air stream must be discarded if exposed to water.

### 1.6 COORDINATION

- A. Coordinate size and location of supports, hangers, and insulation shields. Coordinate clearance requirements with other trades for insulation application.
- B. Schedule insulation application after testing systems. Insulation application may begin on segments of systems that have satisfactory test results.

## PART 2 - PRODUCTS

### 2.1 MANUFACTURERS

- A. Manufacturers: Subject to compliance with requirements, provide products by one of the following:
  - 1. Certainteed
  - 2. Knauf
  - 3. Owens-Corning
  - 4. John Mansville
  - 5. Armstrong
  - 6. Aeroflex USA
  - 7. Nomaco K-Flex
  - 8. Pabco.



## 2.2 PIPING INSULATION MATERIALS

### A. General

1. Supply fiber glass products that have achieved GREENGUARD Children & Schools Certification.
2. Surface Burning Characteristics: Insulation and related materials shall have surface burning characteristics determined by test performed on identical products per ASTM E 84 mounted and installed as per ASTM E 2231. All testing shall be performed by a testing and inspecting agency acceptable to authorities having jurisdiction. Insulation, jacket materials, adhesives, mastics, tapes and cement material containers shall be labeled with appropriate markings of applicable testing and inspecting agency. Flame-spread index of 25 or less, and smoke-developed index of 50 or less.
3. Supply fiber glass products that are manufactured using a certified 25 % minimum recycled content.

### B. Provide thermal hanger shields as specified in Section 230529 "Hangers and Supports for Piping and Equipment".

### C. Glass Fiber:

1. Knauf 1000° Pipe Insulation with ECOSE Technology meeting ASTM C547 Type IV Grade A, ASTM C585, and ASTM C795; rigid, molded, noncombustible per ASTM E136; k value: ASTM C335, 0.23 at 75°F mean temperature. Maximum Service Temperature: 1000°F, or Johns Manville's Micro-Lok® HP meeting ASTM C547, Type I, maximum service temperature of 850°F meeting the other requirements. Vapor Retarder Jacket: ASJ/SSL conforming to ASTM C1136 Type I, secured with self-sealing longitudinal laps and butt strips.
2. PVC Fitting Covers: The Proto Fitting Cover System or Johns Manville Zeston® polyvinyl chloride (PVC) parts shall consist of one piece and two piece pre-molded high impact UV-resistant PVC fitting covers with fiberglass inserts and accessories, which include elbows, tee/valves, end caps, mechanical line couplings, and specialty fittings. Fittings shall be made of Zeston® or LoSMOKE® grade PVC, 25/50 rated per ASTM E-84. Thermal Value of fiberglass insert: K value of 0.26 at 75°F; resistance to fungi and bacteria. (ASTM G 21, ASTM G 22): does not promote growth of fungi or bacteria.

### D. Flexible Elastomeric Insulation: Closed-cell, sponge- or expanded-rubber materials. Comply with ASTM C 534, Type I for tubular materials.

1. For indoor applications, adhesive shall have a VOC content of 50 g/L or less when calculated according to 40 CFR 59, Subpart D (EPA Method 24).
2. Adhesive shall comply with the testing and product requirements of the California Department of Health Services' "Standard Practice for the Testing of Volatile Organic Emissions from Various Sources Using Small-Scale Environmental Chambers."
3. Materials shall have a maximum thermal conductivity of 0.27 Btu-in/h-ft<sup>2</sup>- °F at a 75°F mean temperature when tested in accordance with ASTM C 177 or ASTM C 518, latest revisions.
4. Materials shall have a maximum water vapor transmission of 0.08 perm-inches when tested in accordance with ASTM E 96, Procedure-A, latest revision.

5. Materials shall have a flame spread index of less than 25 and a smoke developed index of less than 50 when tested in accordance with ASTM E 84, latest revision.
6. Provide Armaflex WB finish for outdoor exposed piping.

### 2.3 FIELD-APPLIED JACKETS FOR PIPING

- A. General: ASTM C 921, Type 1, unless otherwise indicated.
- B. PVC: Johns Manville's Zeston® PVC fittings, jacketing, and accessories or Proto Corporation 25/50 or Indoor/Outdoor, UV-resistant fittings, jacketing and accessories, white. Fitting cover system consists of pre-molded, high-impact PVC materials with fiber glass inserts. Fiber glass insert has a thermal conductivity (k value) of 0.26 at 75° F mean temperature. Closures: stainless steel tacks, matching PVC tape, or PVC adhesive per manufacturer's recommendations.

### 2.4 DUCTWORK INSULATION MATERIALS

- A. Flexible Fiber Glass Blanket: Johns Manville's Microlite® XG Duct Wrap or Knauf Friendly Feel® Duct Wrap with ECOSE Technology meeting ASTM C553 Types I, II and III, and ASTM C1290; GREENGUARD certified; flexible, limited combustible; k value: ASTM C177, 0.29 at 75°F mean temperature. Maximum Service Temperature: faced: 250°F; unfaced: 350°F. Vapor Retarder Jacket: FSK conforming to ASTM C1136 Type II. Installation: Maximum allowable compression is 25%. Securement: Secured in place using outward cinching staples in combination with appropriate pressure-sensitive aluminum foil or PSK tape, or in combination with glass fabric and vapor retarder mastic. Density: concealed areas: Minimum 0.75 PCF; exposed areas: Minimum 1.0 PCF.

### 2.5 ACCESSORY MATERIALS

- A. Accessory materials installed as part of insulation work under his section shall include (but not be limited to):
  1. Closure Materials - Butt strips, bands, wires, staples, mastics, adhesives; pressure-sensitive tapes.
  2. Adhesive: As recommended by insulation material manufacturer. Materials shall be compatible with insulation materials, jackets, and substrates and for bonding insulation to itself and to surfaces to be insulated
  3. Support Materials - Hanger straps, hanger rods, saddles, support rings
- B. All accessory materials shall be installed in accordance with manufacturer's instructions.
- C. Mastics: Materials recommended by insulation material manufacturer that are compatible with insulation materials, jackets, and substrates.

## PART 3 - EXECUTION

## 3.1 EXAMINATION &amp; PREPARATION

- A. Examine substrates and conditions for compliance with requirements for installation tolerances and other conditions affecting performance of insulation application. Verify that systems to be insulated have been tested and are free of defects. Verify that surfaces to be insulated are clean and dry.
- B. Proceed with installation only after unsatisfactory conditions have been corrected.
- C. Before starting work under this section, carefully inspect the site and installed work of other trades and verify that such work is complete to the point where installation of materials and accessories under this section can begin.
- D. Ensure that all pipe and fitting surfaces over which insulation is to be installed are clean and dry. Ensure that insulation is clean, dry, and in good mechanical condition with all factory-applied vapor or weather barriers intact and undamaged. Wet, dirty, or damaged insulation shall not be acceptable for installation. Ensure that pressure testing of piping and fittings has been completed prior to installing insulation.

## 3.2 GENERAL APPLICATION REQUIREMENTS

- A. Provide insulation materials, accessories, and finishes according to the manufacturer's written instructions; with smooth, straight, and even surfaces; free of voids throughout, including the length of ducts and fittings, valves, and specialties.
- B. Provide insulation materials, vapor barriers or retarders, jackets, and thicknesses required for each system as specified in insulation system schedules.
- C. Provide accessories compatible with insulation materials and suitable for the service. Provide accessories that do not corrode, soften, or otherwise attack insulation or jacket in either wet or dry state.
- D. Provide insulation with longitudinal seams at top and bottom of horizontal pipe runs and equipment.
- E. Provide multiple layers of insulation with longitudinal and end seams staggered.
- F. Do not weld brackets, clips, or other attachment devices to piping, fittings, and specialties.
- G. Seal joints and seams with vapor-retarder mastic on insulation indicated to receive a vapor retarder.
- H. Keep insulation materials dry during application and finishing.
- I. Provide insulation with tight longitudinal seams and end joints. Bond seams and joints with adhesive recommended by the insulation material manufacturer.

- J. Provide insulation over fittings, valves, and specialties, with continuous thermal and least number of joints practical.
- K. Where vapor barrier is indicated, seal joints, seams, and penetrations in insulation at hangers, supports, anchors, and other projections with vapor-barrier mastic.
  - 1. Install insulation continuously through hangers and specialties around anchor attachments.
  - 2. For insulation application where vapor barriers are indicated, extend insulation on anchor legs from point of attachment to supported item to point of attachment to structure. Taper and seal ends at attachment to structure with vapor-barrier mastic.
  - 3. Install insert materials and install insulation to tightly join the insert. Seal insulation to insulation inserts with adhesive or sealing compound recommended by insulation material manufacturer.
- L. Apply adhesives, mastics, and sealants at manufacturer's recommended coverage rate and wet and dry film thicknesses.
- M. Provide insulation with factory-applied jackets as follows:
  - 1. Draw jacket tight and smooth.
  - 2. Cover circumferential joints with 3-inch- wide strips, of same material as insulation jacket. Secure strips with adhesive and outward clinching staples along both edges of strip, spaced 4 inches o.c.
  - 3. Overlap jacket longitudinal seams at least 1-1/2 inches. Clean and dry surface to receive self-sealing lap. Staple laps with outward clinching staples along edge at 2 inches o.c. For below ambient services, apply vapor-barrier mastic over staples.
  - 4. Cover joints and seams with tape, according to insulation material manufacturer's written instructions, to maintain vapor seal.
  - 5. Where vapor barriers are indicated, apply vapor-barrier mastic on seams and joints and at ends adjacent to duct flanges and fittings.
- N. Cut insulation in a manner to avoid compressing insulation more than 75 percent of its nominal thickness.
- O. Finish installation with systems at operating conditions. Repair joint separations and cracking due to thermal movement.
- P. Repair damaged insulation facings by applying same facing material over damaged areas. Extend patches at least 4 inches beyond damaged areas. Adhere, staple, and seal patches similar to butt joints.

### 3.3 PIPE AND DUCTWORK PENETRATIONS

- A. Insulation Installation at Roof or Aboveground Exterior Wall Penetrations: Install insulation continuously through penetrations.
  - 1. Seal penetrations with flashing sealant.

2. For applications requiring only indoor insulation, terminate insulation above roof/wall surface and seal with joint sealant. For applications requiring indoor and outdoor insulation, install insulation for outdoor applications tightly joined to indoor insulation ends. Seal joint with joint sealant.
  3. Extend jacket of outdoor insulation outside roof/wall flashing at least 2 inches below top of roof flashing.
  4. Seal jacket to roof/wall flashing with flashing sealant.
- B. Insulation Installation at Interior Wall and Partition Penetrations (That Are Not Fire Rated): Install insulation continuously through walls and partitions.
- C. Insulation Installation at Fire-Rated Penetrations:
1. Fire Dampers: Terminate insulation at fire damper sleeves for fire-rated wall and partition penetrations. Externally insulate damper sleeves to match adjacent insulation and overlap duct insulation at least 2 inches.
  2. Pipe or duct penetrations (no fire damper): Install insulation continuously through penetrations of fire-rated walls and partitions. Comply with requirements in Division 7 for firestopping and fire-resistive joint sealers.

### 3.4 INSTALLATION OF PIPING INSULATION

- A. Metal shields shall be installed between hangers or supports and the piping insulation. Provide in accordance with Section 230529.
- B. Insulation Installation on Fittings, Valves, Strainers, Flanges, and Unions:
1. Install insulation over fittings, valves, strainers, flanges, unions, and other specialties with continuous thermal and vapor-retarder integrity unless otherwise indicated.
  2. Insulate pipe elbows using preformed fitting insulation or mitered fittings made from same material and density as adjacent pipe insulation. Each piece shall be butted tightly against adjoining piece and bonded with adhesive. Fill joints, seams, voids, and irregular surfaces with insulating cement finished to a smooth, hard, and uniform contour that is uniform with adjoining pipe insulation.
  3. Insulate tee fittings with preformed fitting insulation or sectional pipe insulation of same material and thickness as used for adjacent pipe. Cut sectional pipe insulation to fit. Butt each section closely to the next and hold in place with tie wire. Bond pieces with adhesive.
  4. Insulate valves using preformed fitting insulation or sectional pipe insulation of same material, density, and thickness as used for adjacent pipe. Overlap adjoining pipe insulation by not less than two times the thickness of pipe insulation, or one pipe diameter, whichever is thicker. For valves, insulate up to and including the bonnets, valve stuffing-box studs, bolts, and nuts. Fill joints, seams, and irregular surfaces with insulating cement.
  5. Insulate strainers using preformed fitting insulation or sectional pipe insulation of same material, density, and thickness as used for adjacent pipe. Overlap adjoining pipe insulation by not less than two times the thickness of pipe insulation, or one pipe diameter, whichever is thicker. Fill joints, seams, and irregular surfaces with insulating cement. Insulate strainers so strainer basket flange or plug can be easily removed and

- replaced without damaging the insulation and jacket. Provide a removable reusable insulation cover. For below-ambient services, provide a design that maintains vapor barrier.
6. Insulate flanges and unions using a section of oversized preformed pipe insulation. Overlap adjoining pipe insulation by not less than two times the thickness of pipe insulation, or one pipe diameter, whichever is thicker.
  7. Cover segmented insulated surfaces with a layer of finishing cement and coat with a mastic. Install vapor-barrier mastic for below-ambient services and a breather mastic for above-ambient services. Reinforce the mastic with fabric-reinforcing mesh. Trowel the mastic to a smooth and well-shaped contour.
  8. For services not specified to receive a field-applied jacket except for flexible elastomeric, install fitted PVC cover over elbows, tees, strainers, valves, flanges, and unions. Terminate ends with PVC end caps. Tape PVC covers to adjoining insulation facing using PVC tape.
- C. Insulate instrument connections for specialties (examples: thermometers, sensors, etc.) on insulated pipes. Shape insulation at these connections by tapering it to and around the connection with insulating cement and finish with finishing cement, mastic, and flashing sealant.
- D. Install removable insulation covers at fittings and equipment that require servicing and locations with service requirements.
- E. Locate seams in the least visible location.
- F. Insulation installed on piping operating below ambient temperatures must have a continuous vapor retarder. All joints, seams and fittings must be sealed. On systems operating above ambient, the butt joints should not be sealed.
- G. Flexible Elastomeric Insulation
1. Seal longitudinal seams and end joints with manufacturers recommended adhesive to eliminate openings in insulation that allow passage of air to surface being insulated.
  2. Insulation Installation on Pipe Flanges: Install pipe insulation to outer diameter of pipe flange. Make width of insulation section same as overall width of flange and bolts, plus twice the thickness of pipe insulation. Fill voids between inner circumference of flange insulation and outer circumference of adjacent straight pipe segments with cut sections of sheet insulation of same thickness as pipe insulation. Secure insulation to flanges and seal seams with manufacturers recommended adhesive to eliminate openings in insulation that allow passage of air to surface being insulated.
  3. Insulation Installation on Pipe Fittings and Elbows: Install mitered sections of pipe insulation. Secure insulation materials and seal seams with manufacturer's recommended adhesive to eliminate openings in insulation that allow passage of air to surface being insulated.
  4. Insulation Installation on Valves and Pipe Specialties: Install preformed valve covers manufactured of same material as pipe insulation when available. When preformed valve covers are not available, install cut sections of pipe and sheet insulation to valve body. Arrange insulation to permit access to packing and to allow valve operation without disturbing insulation. Install insulation to flanges as specified for flange insulation application. Secure insulation to valves and specialties and seal seams with

manufacturer's recommended adhesive to eliminate openings in insulation that allow passage of air to surface being insulated.

5. After adhesive has fully cured, apply two coats of insulation manufacturer's recommended protective coating. Prior to applying the finish, the insulation shall be wiped clean with denatured alcohol. The finish shall not be tinted. To insure good adhesion, the temperature should be above 50 °F during application and drying. Outdoor exposed piping shall have the seams located on the lower half of the pipe.
6. Outdoor exposed piping shall be painted with two coats of Armaflex WB Finish. Prior to applying the Finish, the insulation shall be wiped clean with denatured alcohol. The Finish shall not be tinted. Outdoor exposed piping shall have the seams located on the lower half of the pipe.

### 3.5 INSTALLATION OF DUCTWORK INSULATION

#### A. Flexible Fiberglass Blanket Insulation Installation:

1. Secure with adhesive and insulation pins.
2. Apply adhesives according to manufacturer's recommended coverage rates per unit area, for 100 percent coverage of duct and plenum surfaces.
3. Apply adhesive to entire circumference of ducts and to all surfaces of fittings and transitions.
4. Firmly butt all joints.
5. Where vapor retarder performance is required, all penetrations and damage to the facing shall be repaired using pressure-sensitive tape matching the facing, or mastic prior to system startup. Pressure-sensitive tapes shall be a minimum 3 inches wide and shall be applied with moving pressure using a squeegee or other appropriate sealing tool. Closure shall have a 25/50 Flame Spread/Smoke Developed Rating per UL 723. The longitudinal seam of the vapor retarder must be overlapped a minimum of 2 inches.
6. Install either capacitor-discharge-weld pins and speed washers or cupped-head, capacitor-discharge-weld pins on sides and bottom of horizontal ducts and sides of vertical ducts as follows:
  - a. On duct sides with dimensions 18 inches and smaller, place pins along longitudinal centerline of duct. Space 3 inches maximum from insulation end joints, and 16 inches o.c.
  - b. On duct sides with dimensions larger than 18 inches, place pins 16 inches o.c. each way, and 3 inches maximum from insulation joints. Install additional pins to hold insulation tightly against surface at cross bracing.
  - c. Insulation shall be additionally secured to the bottom of rectangular ductwork over 24 inches wide using mechanical fasteners on 18-inch centers. Care should be exercised to avoid over-compression of the insulation during installation.
  - d. Pins may be omitted from top surface of horizontal, rectangular ducts and plenums.
  - e. Do not over-compress insulation during installation. Install Duct Wrap using manufacturer's stretch-out tables to obtain specified R-value using a maximum compression of 25%.
  - f. Impale insulation over pins and attach speed washers.
  - g. Cut excess portion of pins extending beyond speed washers or bend parallel with insulation surface. Cover exposed pins and washers with tape matching insulation facing.

7. Overlap unfaced blankets a minimum of 2 inches on longitudinal seams and end joints. At end joints, secure with steel bands spaced a maximum of 18 inches o.c.
  8. Install insulation on rectangular duct elbows and transitions with a full insulation section for each surface. Install insulation on round and flat-oval duct elbows with individually mitered gores cut to fit the elbow.
  9. Insulate duct stiffeners, hangers, and flanges that protrude beyond insulation surface with 6-inch- wide strips of same material used to insulate duct. Secure on alternating sides of stiffener, hanger, and flange with pins spaced 6 inches o.c.
- B. For ducts and plenums with surface temperatures below ambient, install a continuous unbroken vapor barrier. Create a facing lap for longitudinal seams and end joints with insulation by removing 2 inches from one edge and one end of insulation segment. Secure laps to adjacent insulation section with 1/2-inch outward-clinching staples, 1 inch o.c. Install vapor barrier consisting of factory- or field-applied jacket, adhesive, vapor-barrier mastic, and sealant at joints, seams, and protrusions.
1. Repair punctures, tears, and penetrations with tape or mastic to maintain vapor-barrier seal.
  2. Install vapor stops for ductwork and plenums operating below 50°F at 18-foot intervals. Vapor stops shall consist of vapor-barrier mastic applied in a Z-shaped pattern over insulation face, along butt end of insulation, and over the surface. Cover insulation face and surface to be insulated a width equal to two times the insulation thickness, but not less than 3 inches.
- C. Fire-rated insulation system installation: Where fire-rated insulation system is indicated, secure system to ducts and duct hangers and supports to maintain a continuous fire rating. Insulate duct access panels and doors to achieve same fire rating as duct.

### 3.6 FIELD QUALITY CONTROL

- A. Tests and Inspections: Inspect pipe, fittings, strainers, and valves, randomly selected by Architect, by removing field-applied jacket and insulation in layers in reverse order of their installation. Extent of inspection shall be limited to three locations of straight pipe, three locations of threaded fittings, three locations of welded fittings, two locations of threaded strainers, two locations of welded strainers, three locations of threaded valves, and three locations of flanged valves for each pipe service defined in the "Piping Insulation Schedule, General" Article.
- B. All insulation applications will be considered defective Work if sample inspection reveals noncompliance with requirements.

### 3.7 PIPING INSULATION APPLICATION SCHEDULE

- A. Application schedules identify piping system and indicate pipe size ranges and material, thickness, and jacket requirements. For piping systems not indicated, insulate to with a similar thickness and type as those specified.



- B. All cold surfaces that may “sweat” must be insulated. Vapor barrier must be maintained, insulation shall be applied with a continuous, unbroken moisture and vapor seal. All hangers, supports, anchors, or other projections that are secured to cold surfaces shall be insulated and vapor sealed to prevent condensation.
- C. For above-ambient services, do not install insulation to the following: testing agency labels and stamps, nameplates, and cleanouts.
- D. Insulation thicknesses and installations shall meet or exceed the requirements of the local energy code, or thicknesses indicated, whichever is of superior insulating performance. If piping type is omitted from list below, provide insulation per energy code or as per similar duty.
- E. Provide PVC jackets in the following locations:
  - 1. Exposed vertical piping in finished spaces.
- F. Domestic hot water:
  - 1. 1/2” thickness, runouts and non-recirculated portions.
  - 2. 1-1/4” and less: Glass Fiber, 1” thickness; 1-1/2 and larger: Glass Fiber, 1.5” thickness: Recirculating piping including the supply and return.
- G. Domestic cold water: Glass Fiber, 1/2” thickness.
- H. AC pan drain or other cold drain piping: Flexible Elastomeric, 1/2” thickness.
- I. Ductless split: 1/2” Armaflex for liquid and gas piping.

### 3.8 DUCT SYSTEM APPLICATIONS

- A. Insulation materials and thicknesses are specified in schedules at the end of this Section. For duct systems not indicated, insulate to with a similar thickness and type as those specified.
- B. Insulation thicknesses and installations shall meet or exceed the requirements of the local energy code, or thicknesses indicated, whichever is of superior insulating performance.
- C. Items Not Insulated: Unless otherwise indicated, do not apply insulation to the following systems, materials, and equipment:
  - 1. Metal ducts with duct liner.
  - 2. Factory-insulated flexible ducts.
  - 3. Flexible connectors.

3.9 DUCT AND PLENUM APPLICATION SCHEDULE

- A. Supply Ducts: Flexible Fiber Glass Blanket: R-6, 1.5” thickness.
- B. Return ducts: None required.

END OF SECTION 230700

## SECTION 230900 – DIRECT DIGITAL CONTROL (DDC) SYSTEM

### PART 1 - GENERAL

#### 1.1 SUMMARY

- A. Provide all labor, materials, equipment, and service necessary for a complete and operating building automation system.
- B. The Controls Contractor's work shall consist of the provision of all labor, materials, special tools, equipment, enclosures, power supplies, software, software licenses, project-specific software configurations and database entries, interfaces, wiring, tubing, installation, labeling, engineering, calibration, documentation, submittals, testing, verification, training services, permits and licenses, transportation, shipping, handling, administration, supervision, management, insurance, warranty, specified services and items required by the Contract that are required for the functional turn-key operation of the complete and fully functional Controls Systems. Documents are diagrammatic only. Equipment and labor not specifically referred to herein or on the plans, which are required to meet the functional intent, shall be provided without additional cost to the Owner.
- C. Related Sections include the following:
  - 1. Drawings and general provisions of the Contract, including General and Supplementary Conditions and Division 1 Specification Sections, apply to this Section.
  - 2. Division 13 Section "Fire Alarm"
  - 3. Division 23 Section "Common Work Results for Mechanical"
  - 4. Division 23 Sections with controller interfaces shall be integrated with the work of this Section.
  - 5. Division 23 Section "Testing, Adjusting, and Balancing"
  - 6. Division 26
- D. Products Furnished but Not Installed under This Section
- E. Control Dampers
  - 1. Automated Dampers
- F. Products Not Furnished or Installed under but Integrated with the Work of This Section
  - 1. VAV Air terminal Units

#### 1.2 RELATED SECTIONS

- A. The General Conditions of the Contract, Supplementary Conditions, and General Requirements are part of this specification and shall be used in conjunction with this section as part of the contract documents.

B. The following sections constitute related work:

1. Division 1
2. Division 26.

### 1.3 DESCRIPTION

- A. General: The control system shall consist of a high-speed, peer-to-peer network of DDC controllers, a control system server, and an operator interface.
- B. System software shall be based on a server/thin client architecture, designed around the open standards of web technology. The control system server shall be accessed using a Web browser over the control system network, the owner's local area network, and (at the owner's discretion) over the Internet. The intent of the thin-client architecture is to provide operators complete access to the control system via a Web browser. No special software other than a web browser shall be required to access graphics, point displays, and trends, configure trends, configure points and controllers, or to download programming into the controllers.
- C. System shall use the BACnet protocol for communication to the operator workstation or web server and for communication between control modules. I/O points, schedules, setpoints, trends and alarms specified in "Sequence of Operations for HVAC Controls" shall be BACnet objects.

### 1.4 APPROVED CONTROL SYSTEM:

- A. Use control system hardware and software that meet the requirements of this specification.
  1. Automated Logic by Trident Controls, Inc.

### 1.5 QUALITY ASSURANCE

- A. Installer and Manufacturer Qualifications
  1. Installer shall have an established working relationship with Control System Manufacturer.
  2. Installer shall have successfully completed Control System Manufacturer's control system training. Upon request, Installer shall present record of completed training including course outlines.
  3. The BMS Contractor shall provide work in a neat and workmanlike manner that is acceptable to the Owner.
- B. Acceptable Installer: Trident Controls, Inc, 238 Portland Road, Gray Maine 04039

1.6 CODES AND STANDARDS

- A. Work, materials and equipment shall comply with the most restrictive of local, state and federal authorities' codes and ordinances or these plans and specifications. As a minimum, the installation shall comply with the current editions in effect 30 days prior to the receipt of bids of the following codes:
  - 1. National Electric Code (NEC)
  - 2. International Building Code (IBC)
  - 3. ANSI/ASHRAE Standard 135, BACnet - A Data Communication Protocol for Building Automation and Control Systems

1.7 SYSTEM PERFORMANCE

- A. Performance Standards. System shall conform to the following minimum standards over network connections. Systems shall be tested using manufacturer's recommended hardware and software for operator workstations (server and browser for web-based systems).
  - 1. Graphic Display. A graphic with 20 dynamic points shall display with current data within 10 sec.
  - 2. Graphic Refresh. A graphic with 20 dynamic points shall update with current data within 8 seconds and shall automatically refresh every 15 sec.
  - 3. Configuration and Tuning Screens. Screens used for configuring, calibrating, or tuning points, PID loops, and similar control logic shall automatically refresh within 6 sec.
  - 4. Object Command. Devices shall react to command of a binary object within 2 sec. Devices shall begin reacting to command of an analog object within 2 sec.
  - 5. Program Execution Frequency. Custom and standard applications shall be capable of running as often as once every 5 sec. Select execution times consistent with the mechanical process under control.
  - 6. Performance. Programmable controllers shall be able to completely execute DDC PID control loops at a frequency adjustable down to once per sec. Select execution times consistent with the mechanical process under control.
  - 7. Multiple Alarm Annunciation. Each workstation on the network shall receive alarms within 5 sec of other workstations.
  - 8. Reporting Accuracy. System shall report values with minimum end-to-end accuracy listed in Table 1.
  - 9. Control Stability and Accuracy. Control loops shall maintain measured variable at setpoint within tolerances listed in Table 2.

Table-1  
 Reporting Accuracy

Measured Variable	Reported Accuracy
Space Temperature	±0.5°C (±1°F)
Ducted Air	±0.5°C (±1°F)
Outside Air	±1.0°C (±2°F)
Dew Point	±1.5°C (±3°F)
Relative Humidity	±5% RH
Airflow (terminal)	±10% of full scale (see Note 1)

Air Pressure (ducts)	±25 Pa (±0.1 in. w.g.)
Electrical	±1% of reading (see Note 3)
Carbon Dioxide (CO2)	±50 ppm

Note 1: Accuracy applies to 10%–100% of scale  
 Note 2: For both absolute and differential pressure  
 Note 3: Not including utility-supplied meters

Table 2  
 Control Stability and Accuracy

Controlled Variable	Control Accuracy	Range of Medium
Air Pressure	±50 Pa (±0.2 in. w.g.) ±3 Pa (±0.01 in. w.g.)	0–1.5 kPa (0–6 in. w.g.) -25 to 25 Pa (-0.1 to 0.1 in. w.g.)
Airflow	±10% of full scale	
Space Temperature	±1.0°C (±2.0°F)	
Duct Temperature	±1.5°C (±3°F)	
Humidity	±5% RH	
Fluid Pressure	±10 kPa (±1.5 psi) ±250 Pa (±1.0 in. w.g.)	MPa (1–150 psi) 0–12.5 kPa (0–50 in. w.g.) differential

1.8 SUBMITTALS

- A. Product Data and Shop Drawings: The contractor shall provide shop drawings or other submittals on hardware, software, and equipment to be installed or provided. No work may begin on any segment of this project until submittals have been approved for conformity with design intent. Provide drawings as a PDF document. Provide in accordance with Division 1.
- B. When manufacturer’s cutsheets apply to a product series rather than a specific product, the data specifically applicable to the project shall be highlighted or clearly indicated by other means. Each submitted piece of literature and drawing shall clearly reference the specification and/or drawing that the submittal is to cover. General catalogs shall not be accepted as cutsheets to fulfill submittal requirements. Select and show submittal quantities appropriate to scope of work. Submittal approval does not relieve Contractor of responsibility to supply sufficient quantities to complete work. Submittals shall include:

1. DDC System Hardware

- a. A complete bill of materials to be used indicating quantity, manufacturer, model number, and relevant technical data of equipment to be used.
- b. Manufacturer’s description and technical data such as performance curves, product specifications, and installation and maintenance instructions for items listed below and for relevant items not listed below:
  - 1) Direct digital controllers (controller panels)
  - 2) Transducers and transmitters
  - 3) Sensors (including accuracy data)
  - 4) Actuators
  - 5) Valves

- 6) Relays and switches
  - 7) Control panels
  - 8) Power supplies
  - 9) Batteries
  - 10) Operator interface equipment
  - 11) Wiring
- c. Wiring diagrams and layouts for each control panel. Show termination numbers.
  - d. Schematic diagrams for all field sensors and controllers. Provide floor plans of all sensor locations and control hardware. Riser diagrams showing control network layout, communication protocol, and wire types.
2. Central System Hardware and Software
- a. A complete bill of material of equipment used indicating quantity, manufacturer, model number, and relevant technical information.
  - b. Manufacturer's description and technical data such as product specifications and installation and maintenance instructions for items listed below and for relevant items furnished under this contract not listed below:
    - i. Central Processing Unit (CPU) or web server
    - ii. Monitors
    - iii. Keyboards
    - iv. Power supplies
    - v. Battery backups
    - vi. Interface equipment between CPU or server and control panels
    - vii. Operating System software
    - viii. Operator interface software
    - ix. Color graphic software
    - x. Third-party software
  - c. Schematic diagrams for all control, communication, and power wiring. Provide a schematic drawing of the central system installation. Label all cables and ports with computer manufacturers' model numbers and functions. Show interface wiring to control system.
  - d. Network riser diagrams of wiring between central control unit and control panels.
3. Controlled Systems
- a. Riser diagrams showing control network layout, communication protocol, and wire types.
  - b. A schematic diagram of each controlled system. The schematics shall have all control points labeled with point names shown or listed. The schematics shall graphically show the location of all control elements in the system.
  - c. A schematic wiring diagram of each controlled system. Label control elements and terminals. Where a control element is also shown on control system schematic, use the same name.
  - d. An instrumentation list (Bill of Materials) for each controlled system. List each control system element in a table. Show element name, type of device, manufacturer, model number, and product data sheet number.

- e. A mounting, wiring, and routing plan-view drawing. The design shall take into account HVAC, electrical, and other systems' design and elevation requirements.
  - f. A complete description of the operation of the control system, including sequences of operation. The description shall include and reference a schematic diagram of the controlled system.
  - g. A point list for each control system. List I/O points and software points. Indicate alarmed and trended points.
4. Quantities of items submitted shall be reviewed but are the responsibility of the Contractor.
  5. Description of process, report formats, and checklists to be used in Control System Demonstration and Acceptance.
  6. BACnet Protocol Implementation Conformance Statement (PICS) for each submitted type of controller and operator interface.

C. Schedules

1. Within one month of contract award, provide a schedule of the work indicating the following:
  - a. Intended sequence of work items
  - b. Start date of each work item
  - c. Duration of each work item
  - d. Planned delivery dates for ordered material and equipment and expected lead times
  - e. Milestones indicating possible restraints on work by other trades or situations
2. Monthly written status reports indicating work completed and revisions to expected delivery dates. Include updated schedule of work.

D. Project Record Documents. Upon completion of installation, a PDF of the documents shall be submitted for approval prior to final completion and shall include:

1. Project Record Drawings. As-built versions of submittal shop drawings provided as PDF file via. Email or on magnetic or optical media.
2. Testing and Commissioning Reports and Checklists. Completed versions of reports, checklists, and trend logs used to meet requirements of Control System Demonstration and Acceptance.
3. Operation and Maintenance (O&M) Manual.
4. As-built versions of submittal product data.
5. Names, addresses, and telephone numbers of installing contractors and service representatives for equipment and control systems.
6. Operator's manual with procedures for operating control systems: logging on and off, handling alarms, producing point reports, trending data, overriding computer control, and changing setpoints and variables.
7. Programming manual or set of manuals with description of programming language and syntax, of statements for algorithms and calculations used, of point database creation and modification, of program creation and modification, and of editor use.
8. Engineering, installation, and maintenance manual or set of manuals that explains how to design and install new points, panels, and other hardware; how to perform preventive



- maintenance and calibration; how to debug hardware problems; and how to repair or replace hardware.
9. Documentation of programs created using custom programming language including setpoints, tuning parameters, and object database. Electronic copies of programs shall meet this requirement if control logic, setpoints, tuning parameters, and objects can be viewed using furnished programming tools.
  10. Graphic files, programs, and database on magnetic or optical media.
  11. List of recommended spare parts with part numbers and suppliers.
  12. Complete original-issue documentation, installation, and maintenance information for furnished third-party hardware including computer equipment and sensors.
  13. Complete original-issue copies of furnished software, including operating systems, custom programming language, operator workstation or web server software, and graphics software.
  14. Licenses, guarantees, and warranty documents for equipment and systems.
  15. Recommended preventive maintenance procedures for system components, including schedule of tasks such as inspection, cleaning, and calibration; time between tasks; and task descriptions.

## 1.9 WARRANTY

### A. Warrant work as follows:

1. Warrant labor and materials for specified control system free from defects for a period of 12 months after final acceptance. Control system failures during warranty period shall be adjusted, repaired, or replaced at no additional cost or reduction in service to Owner. Respond during normal business hours within 24 hours of Owner's warranty service request.
2. Work shall have a single warranty date, even if Owner receives beneficial use due to early system start-up. If specified work is split into multiple contracts or a multi-phase contract, each contract or phase shall have a separate warranty start date and period.
3. If the engineer determines that equipment and systems operate satisfactorily at the end of final start-up, testing, and commissioning phase, the engineer will certify in writing that control system operation has been tested and accepted in accordance with the terms of this specification. Date of acceptance shall begin warranty period.
4. Provide updates to operator workstation or web server software, project-specific software, graphic software, database software, and firmware that resolve the contractor-identified software deficiencies at no charge during warranty period. If available, Owner can purchase in-warranty service agreement to receive upgrades for functional enhancements associated with above-mentioned items. Do not install updates or upgrades without Owner's written authorization.
5. Exception: Contractor shall not be required to warrant reused devices except those that have been rebuilt or repaired. Installation labor and materials shall be warranted. Demonstrate operable condition of reused devices at time of Engineer's acceptance.

## 1.10 OWNERSHIP OF PROPRIETARY MATERIAL

- ### A. Project-specific software and documentation shall become Owner's property. This includes, but is not limited to:

1. Graphics
2. Record drawings
3. Database
4. Application programming code
5. Documentation

1.11 DEFINITIONS

Term	Definition
BACnet Interoperability Building Blocks (BIBB)	A BIBB defines a small portion of BACnet functionality that is needed to perform a particular task. BIBBS are combined to build the BACnet functional requirements for a device in a specification.
BACnet/BACnet Standard	BACnet communication requirements as defined by the latest version of ASHRAE/ANSI 135 and approved addenda.
Control Systems Server	A computer(s) that maintain(s) the systems configuration and programming database.
Controller	Intelligent stand-alone control device. Controller is a generic reference to building controllers, custom application controllers, and application specific controllers.
Direct Digital Control	Microprocessor-based control including Analog/Digital conversion and program logic.
Gateway	Bi-directional protocol translator connecting control systems that use different communication protocols.
Local Area Network	Computer or control system communications network limited to local building or campus.
Master-Slave/Token Passing	Data link protocol as defined by the BACnet standard.
Point-to-Point	Serial communication as defined in the BACnet standard.
Primary Controlling LAN	High speed, peer-to-peer controller LAN connecting BCs and optionally AACs and ASCs. Refer to System Architecture below.
Protocol Implementation Conformance Statement	A written document that identifies the particular options specified by BACnet that are implemented in a device.
Router	A device that connects two or more networks at the network layer.
Wiring	Raceway, fittings, wire, boxes and related items.

PART 2 - PRODUCTS

2.1 MATERIALS

- A. Use new products the manufacturer is currently manufacturing and selling for use in new installations. Do not use this installation as a product test site unless explicitly approved in writing by Owner. Spare parts shall be available for at least five years after completion of this contract. The DDC System shall be fully compatible with all the existing controllers, workstations and user interfaces

## 2.2 COMMUNICATION

- A. Control products, communication media, connectors, repeaters, hubs, and routers shall comprise a BACnet internetwork. Controller and operator interface communication shall conform to ANSI/ASHRAE Standard 135, BACnet.
- B. Install new wiring and network devices as required to provide a complete and workable control network.
- C. Use existing Ethernet backbone for network segments marked "existing" on project drawings.
- D. Each controller shall have a communication port for temporary connection to a laptop computer or other operator interface. Connection shall support memory downloads and other commissioning and troubleshooting operations.
- E. Internetwork operator interface and value passing shall be transparent to internetwork architecture.
  - 1. An operator interface connected to a controller shall allow the operator to interface with each internetwork controller as if directly connected. Controller information such as data, status, and control algorithms shall be viewable and editable from each internetwork controller.
  - 2. Inputs, outputs, and control variables used to integrate control strategies across multiple controllers shall be readable by each controller on the internetwork. Program and test all cross-controller links required to execute control strategies specified in Section 23 09 93. An authorized operator shall be able to edit cross-controller links by typing a standard object address or by using a point-and-click interface.
- F. Workstations, Building Control Panels, and Controllers with real-time clocks shall use the BACnet Time Synchronization service. System shall automatically synchronize system clocks daily from an operator-designated device via the internetwork. The system shall automatically adjust for daylight saving and standard time as applicable.
- G. System shall be expandable to at least twice the required input and output objects with additional controllers, associated devices, and wiring.

## 2.3 OPERATOR INTERFACE

- A. The Operator Workstation or server shall conform to the BACnet Operator Workstation (B-OWS) or BACnet Advanced Workstation (B-AWS) device profile as specified in ASHRAE/ANSI 135 BACnet Annex L.
- B. Operator Interface. Web server shall reside on high-speed network with building controllers. Each standard browser connected to server shall be able to access all system information.
- C. Communication. Web server or workstation and controllers shall communicate using BACnet protocol. Web server or workstation and control network backbone shall communicate using ISO 8802-3 (Ethernet) Data Link/Physical layer protocol and BACnet/IP addressing as specified in ANSI/ASHRAE 135, BACnet Annex J.

D. Hardware. Each workstation or web server shall consist of the following:

1. Computer. Industry-standard hardware shall meet or exceed DDC system manufacturer's recommended specifications and shall meet response times specified elsewhere in this document. The following hardware requirements also apply:
  - a. The hard disk shall have sufficient memory to store:
    - 1) All required operator workstation software.
    - 2) A DDC database at least twice the size of the delivered system database.
    - 3) One year of trend data based on the points specified to be trended at their specified trend intervals.
  - b. Provide additional hardware (communication ports, video drivers, network interface cards, cabling, etc.) to facilitate all control functions and software requirements specified for the DDC system.
  - c. Minimum hardware configuration shall include the following:
    - 1) Dual or Quad Core Processor
    - 2) 8 GB RAM
    - 3) 500 GB hard disk providing data at 3.0 Gb/sec
    - 4) 16x DVD-RW drive
    - 5) Serial, parallel, and network communication ports and cables as required for proper DDC system operation.

E. System Software.

1. Operating System. Web server or workstation shall have an industry-standard professional-grade operating system. Operating system shall meet or exceed the DDC System manufacturer's minimum requirements for their software. Typically acceptable systems include Microsoft Windows7, Windows Server 2012 or 2008, Red Hat Enterprise Linux, or Ubuntu Desktop 10.04.
2. System Graphics. The operator interface software shall be graphically based and shall include at least one graphic per piece of equipment or occupied zone, graphics for each chilled water and hot water system, and graphics that summarize conditions on each floor of each building included in this contract.
  - a. Functionality. Graphics shall allow operator to monitor system status, to view a summary of the most important data for each controlled zone or piece of equipment, to use point-and-click navigation between zones or equipment, and to edit setpoints and other specified parameters.
  - b. Animation. Graphics shall be able to animate by displaying different image files for changed object status.
  - c. Alarm Indication. Indicate areas or equipment in an alarm condition using color or other visual indicator.
  - d. Format. Graphics shall be saved in an industry-standard format such as BMP, JPEG, PNG, or GIF. Web-based system graphics shall be viewable on browsers compatible with World Wide Web Consortium browser standards. Web graphic format shall require no plug-in (such as HTML and JavaScript) or shall only require widely available no-cost plug-ins (such as Active-X and Adobe Flash).

3. Custom Graphics. Custom graphic files shall be created with the use of a graphics generation package furnished with the system. The graphics generation package shall be a graphically based system that uses the mouse to create and modify graphics that are saved in the same formats as are used for system graphics.
  4. Graphics Library. Furnish a complete library of standard HVAC equipment graphics such as chillers, boilers, air handlers, terminals, fan coils, and unit ventilators. This library also shall include standard symbols for other equipment including fans, pumps, coils, valves, piping, dampers, and ductwork. The library shall be furnished in a file format compatible with the graphics generation package program.
- F. System Applications. System shall provide the following functionality to authorized operators as an integral part of the operator interface or as stand-alone software programs. If furnished as part of the interface, the tool shall be available from each workstation or web browser interface. If furnished as a stand-alone program, software shall be installable on standard IBM-compatible PCs with no limit on the number of copies that can be installed under the system license.
1. Automatic System Database Configuration. Each workstation or web server shall store on its hard disk a copy of the current system database, including controller firmware and software. Stored database shall be automatically updated with each system configuration or controller firmware or software change.
  2. Manual Controller Memory Download. Operators shall be able to download memory from the system database to each controller.
  3. System Configuration. The workstation software shall provide a method of configuring the system. This shall allow for future system changes or additions by users under proper password protection. Operators shall be able to configure the system.
  4. On-Line Help. Provide a context-sensitive, on-line help system to assist the operator in operating and editing the system. On-line help shall be available for all applications and shall provide the relevant data for that particular screen. Additional help information shall be available through the use of hypertext.
  5. Security. Each operator shall be required to log on to the system with user name and password in order to view, edit, add, or delete data.
    - a. Operator Access. The user name and password combination shall define accessible viewing, editing, adding, and deleting privileges for that operator. Users with system administrator rights shall be able to create new users and edit the privileges of all existing users. System Administrators shall also be able to vary and deny each operator's privileges based on the geographic location, such as the ability to edit operating parameters in Building A, to view but not edit parameters in Building B, and to not even see equipment in Building C.
    - b. Automatic Log Out. Automatically log out each operator if no keyboard or mouse activity is detected. This auto logoff time shall be user adjustable.
    - c. Encrypted Security Data. Store system security data including operator passwords in an encrypted format. System shall not display operator passwords.
  6. System Diagnostics. The system shall automatically monitor the operation of all building management panels and controllers. The failure of any device shall be annunciated to the operator.
  7. Alarm Processing. System input and status objects shall be configurable to alarm on departing from and on returning to normal state. Operator shall be able to enable or disable each alarm and to configure alarm limits, alarm limit differentials, alarm states,

and alarm reactions for each system object. Configure and enable alarm points as specified in the Sequences of Operation. Alarms shall be BACnet alarm objects and shall use BACnet alarm services.

8. Alarm Messages. Alarm messages shall use the English language descriptor for the object in alarm in such a way that the operator will be able to recognize the source, location, and nature of the alarm without relying on acronyms.
  9. Alarm Reactions. Operator shall be able to configure (by object) what, if any actions are to be taken during an alarm. As a minimum, the workstation or web server shall be able to log, print, start programs, display messages, send e-mail, send page, and audibly annunciate.
  10. Alarm and Event log. Operators shall be able to view all system alarms and changes of state from any location in the system. Events shall be listed chronologically. An operator with the proper security level may acknowledge and delete alarms, and archive closed alarms to the workstation or web server hard disk.
  11. Trend Logs. The operator shall be able to configure trend sample or change of value (COV) interval, start time, and stop time for each system data object and shall be able to retrieve data for use in spreadsheets and standard database programs. Controller shall sample and store trend data and shall be able to archive data to the hard disk. Configure trends as specified in the Sequences of Operation. Trends shall be BACnet trend objects.
  12. Object and Property Status and Control. Provide a method for the operator to view, and edit if applicable, the status of any object or property in the system. The status shall be available by menu, on graphics, or through custom programs.
  13. Reports and Logs. Operator shall be able to select, to modify, to create, and to print reports and logs. Operator shall be able to store report data in a format accessible by standard spreadsheet and word processing programs.
  14. Standard Reports. Furnish the following standard system reports:
    - a. Objects. System objects and current values filtered by object type, by status (in alarm, locked, normal), by equipment, by geographic location, or by combination of filter criteria.
    - b. Alarm Summary. Current alarms and closed alarms. System shall retain closed alarms for an adjustable period.
    - c. Logs. System shall log the following to a database or text file and shall retain data for an adjustable period:
      - 1) Alarm History.
      - 2) Trend Data. Operator shall be able to select trends to be logged.
      - 3) Operator Activity. At a minimum, system shall log operator log in and log out, control parameter changes, schedule changes, and alarm acknowledgment and deletion. System shall date and time stamp logged activity.
- G. Workstation Application Editors. Each PC or browser workstation shall support editing of all system applications. The applications shall be downloaded and executed at one or more of the controller panels.
1. Controller. Provide a full-screen editor for each type of application that shall allow the operator to view and change the configuration, name, control parameters, and set points for all controllers.

2. Scheduling. An editor for the scheduling application shall be provided at each workstation. Provide a method of selecting the desired schedule and schedule type. Exception schedules and holidays shall be shown clearly on the calendar. The start and stop times for each object shall be adjustable from this interface.
  3. Custom Application Programming. Provide the tools to create, edit, debug, and download custom programs. System shall be fully operable while custom programs are edited, compiled, and downloaded. Programming language shall have the following features:
    - a. Language. Language shall be graphically based language shall use function blocks arranged in a logic diagram that clearly shows control logic flow. Function blocks shall directly provide functions listed below, and operators shall be able to create custom or compound function blocks.
    - b. A full-screen character editor programming environment shall be provided. The editor shall be cursor/mouse-driven and allow the user to insert, add, modify, and delete custom programming code. It also shall incorporate features such as cut/paste and find.
    - c. The programming language shall allow independently executing program modules to be developed. Each module shall be able to independently enable and disable other modules.
    - d. The editor/programming environment shall have a debugging/simulation capability that allows the user to step through the program and observe any intermediate values and/or results.
    - e. The programming language shall support conditional statements (IF/THEN/ELSE/ELSE-IF) using compound Boolean (AND, OR, and NOT) and/or relations (EQUAL, LESS THAN, GREATER THAN, NOT EQUAL) comparisons.
    - f. The programming language shall support floating-point arithmetic using the following operators: +, -, ÷, ×, and square root. The following mathematical functions also shall be provided: absolute value and minimum/maximum value.
    - g. The programming language shall have predefined variables that represent time of day, day of the week, month of the year, and the date. Other predefined variables shall provide elapsed time in seconds, minutes, hours, and days. These elapsed time variables shall be able to be reset by the language so that interval-timing functions can be stopped and started within a program. Values from all of the above variables shall be readable by the language so that they can be used in a program for such purposes as IF/ THEN comparisons, calculations, etc.
    - h. The language shall be able to read the values of the variables and use them in programming statement logic, comparisons, and calculations.
    - i. The programming language shall have predefined variables representing the status and results of the system software and shall be able to enable, disable, and change the setpoints of the system software described below.
- H. Portable Operator's Terminal. Provide all necessary software to configure an IBM-compatible laptop computer for use as a Portable Operator's Terminal. Operator shall be able to connect configured Terminal to the system network or directly to each controller for programming, setting up, and troubleshooting.

## 2.4 CONTROLLER SOFTWARE

- A. Furnish the following applications for building and energy management. All software application shall reside and operate in the system controllers. Applications shall be editable through operator workstation, web browser interface, or engineering workstation.
- B. System Security. See Paragraph 2.3.E.5 (Security) and Paragraph 2.3.E.14.c.iii (Operator Activity).
- C. Scheduling. Provide the capability to execute control functions according to a user created or edited schedule. Each schedule shall provide the following schedule options as a minimum:
  - 1. Weekly Schedule. Provide separate schedules for each day of the week. Each schedule shall be able to include up to 5 occupied periods (5 start-stop pairs or 10 events).
  - 2. Exception Schedules. Provide the ability for the operator to designate any day of the year as an exception schedule. Exception schedules may be defined up to a year in advance. Once an exception schedule has executed, the system shall discard and replace the exception schedule with the standard schedule for that day of the week.
  - 3. Holiday Schedules. Provide the capability for the operator to define up to 24 special or holiday schedules. These schedules will be repeated each year. The operator shall be able to define the length of each holiday period.
- D. System Coordination. Operator shall be able to group related equipment based on function and location and to use these groups for scheduling and other applications.
- E. Binary Alarms. Each binary object shall have the capability to be configured to alarm based on the operator-specified state. Provide the capability to automatically and manually disable alarming.
- F. Analog Alarms. Each analog object shall have both high and low alarm limits. The operator shall be able to enable or disable these alarms.
- G. Alarm Reporting. The operator shall be able to determine the action to be taken in the event of an alarm. An alarm shall be able to start programs, print, be logged in the event log, generate custom messages, and display on graphics.
- H. Remote Communication. System shall automatically contact operator workstation or server on receipt of critical alarms.
- I. Demand Limiting.
  - 1. The demand-limiting program shall monitor building power consumption from a building power meter (provided by others) which generates pulse signals or a BACnet communications interface. An acceptable alternative is for the system to monitor a watt transducer or current transformer attached to the building feeder lines.
  - 2. When power consumption exceeds adjustable levels, system shall automatically adjust setpoints, de-energize low-priority equipment, and take other programmatic actions to reduce demand as specified in the Sequences of Operation. When demand drops below adjustable levels, system shall restore loads as specified.



- J. Maintenance Management. The system shall be capable of generating maintenance alarms when equipment exceeds adjustable runtime, equipment starts, or performance limits. Configure and enable maintenance alarms as specified in the Sequences of Operation.
- K. Sequencing. Application software shall sequence chillers, boilers, and pumps as specified in the Sequences of Operation.
- L. PID Control. System shall provide direct- and reverse-acting PID (proportional-integral-derivative) algorithms. Each algorithm shall have anti-windup and selectable controlled variable, setpoint, and PID gains. Each algorithm shall calculate a time-varying analog value that can be used to position an output or to stage a series of outputs. The calculation interval, PID gains, and other tuning parameters shall be adjustable by a user with the correct security level.
- M. Staggered Start. System shall stagger controlled equipment restart after power outage. Operator shall be able to adjust equipment restart order and time delay between equipment restarts.
- N. Energy Calculations.
  - 1. The system shall accumulate and convert instantaneous power (kW) or flow rates (L/s [gpm]) to energy usage data.
  - 2. The system shall calculate a sliding-window average (rolling average). Operator shall be able to adjust window interval to 15 minutes, 30 minutes, or 60 minutes.
- O. Anti-Short Cycling. All binary output objects shall be protected from short cycling by means of adjustable minimum on-time and off-time settings.
- P. On and Off Control with Differential. Provide an algorithm that allows a binary output to be cycled based on a controlled variable and a setpoint. The algorithm shall be direct-acting or reverse-acting.
- Q. Runtime Totalization. Provide software to totalize runtime for each binary input and output. Operator shall be able to enable runtime alarm based on exceeded adjustable runtime limit. Configure and enable runtime totalization and alarms as specified in Section 23 09 93 (Sequence of Operations)

## 2.5 CONTROLLERS

- A. General. Provide an adequate number of Building Controllers (BC), Advanced Application Controllers (AAC), Application Specific Controllers (ASC), Smart Actuators (SA), and Smart Sensors (SS). Every device in the system which executes control logic and directly controls HVAC equipment must conform to a standard BACnet Device profile as specified in ANSI/ASHRAE 135, BACnet Annex
- B. Unless otherwise specified, hardwired actuators and sensors may be used in lieu of BACnet Smart Actuators and Smart Sensors.

## C. BACnet.

1. Building Controllers (BCs). Each BC shall conform to BACnet Building Controller (B-BC) device profile as specified in ANSI/ASHRAE 135, BACnet Annex L, and shall be listed as a certified B-BC in the BACnet Testing Laboratories (BTL) Product Listing.
2. Advanced Application Controllers (AACs). Each AAC shall conform to BACnet Advanced Application Controller (B-AAC) device profile as specified in ANSI/ASHRAE 135, BACnet Annex L and shall be listed as a certified B-AAC in the BACnet Testing Laboratories (BTL) Product Listing.
3. Application Specific Controllers (ASCs). Each ASC shall conform to BACnet Application Specific Controller (B-ASC) device profile as specified in ANSI/ASHRAE 135, BACnet Annex L and shall be listed as a certified B-ASC in the BACnet Testing Laboratories (BTL) Product Listing.
4. Smart Sensors (SSs). Each SS shall conform to BACnet Smart Sensor (B-SS) device profile as specified in ANSI/ASHRAE 135, BACnet Annex L and shall be listed as a certified B-SS in the BACnet Testing Laboratories (BTL) Product Listing.
5. BACnet Communication.
  - a. Each BC shall reside on or be connected to a BACnet network using ISO 8802-3 (Ethernet) Data Link/Physical layer protocol and BACnet/IP addressing.
  - b. BACnet routing shall be performed by BCs or other BACnet device routers as necessary to connect BCs to networks of AACs and ASCs.
  - c. Each AAC shall reside on a BACnet network using ISO 8802-3 (Ethernet) Data Link/Physical layer protocol with BACnet/IP addressing, or it shall reside on a BACnet network using the ARCNET or MS/TP Data Link/Physical layer protocol.
  - d. Each ASC shall reside on a BACnet network using the ARCNET or MS/TP Data Link/Physical layer protocol.
  - e. Each SA shall reside on a BACnet network using the ARCNET or MS/TP Data Link/Physical layer protocol.
  - f. Each SS shall reside on a BACnet network using ISO 8802-3 (Ethernet) Data Link/Physical layer protocol with BACnet/IP addressing, or it shall reside on a BACnet network using ARCNET or MS/TP Data Link/Physical layer protocol.

## D. Communication

1. Service Port. Each controller shall provide a service communication port for connection to a Portable Operator's Terminal. Connection shall be extended to space temperature sensor ports where shown on drawings.
2. Signal Management. BC and ASC operating systems shall manage input and output communication signals to allow distributed controllers to share real and virtual object information and to allow for central monitoring and alarms.
3. Data Sharing. Each BC and AAC shall share data as required with each networked BC and AAC.
4. Stand-Alone Operation. Each piece of equipment shall be controlled by a single controller to provide stand-alone control in the event of communication failure. All I/O points specified for a piece of equipment shall be integral to its controller. Provide stable and reliable stand-alone control using default values or other method for values normally read over the network such as outdoor air conditions, supply air or water temperature coming from source equipment, etc.

- E. Environment. Controller hardware shall be suitable for anticipated ambient conditions.
  - 1. Controllers used outdoors or in wet ambient conditions shall be mounted in waterproof enclosures and shall be rated for operation at -29°C to 60°C (-20°F to 140°F).
  - 2. Controllers used in conditioned space shall be mounted in dust-protective enclosures and shall be rated for operation at 0°C to 50°C (32°F to 120°F).
- F. Keypad. Provide a local keypad and display for each BC and AAC. Operator shall be able to use keypad to view and edit data. Keypad and display shall require password to prevent unauthorized use. If the manufacturer does not normally provide a keypad and display for each BC and AAC, provide the software and any interface cabling needed to use a laptop computer as a Portable Operator's Terminal for the system.
- G. Real-Time Clock. Controllers that perform scheduling shall have a real-time clock.
- H. Serviceability. Provide diagnostic LEDs for power, communication, and processor. All wiring connections shall be made to a field-removable modular terminal strip or to a termination card connected by a ribbon cable. Each BC and AAC shall continually check its processor and memory circuit status and shall generate an alarm on abnormal operation. System shall continuously check controller network and generate alarm for each controller that fails to respond.
- I. Memory.
  - 1. Controller memory shall support operating system, database, and programming requirements.
  - 2. Each BC and AAC shall retain BIOS and application programming for at least 72 hours in the event of power loss.
  - 3. Each ASC and SA shall use nonvolatile memory and shall retain BIOS and application programming in the event of power loss. System shall automatically download dynamic control parameters following power loss.
- J. Immunity to Power and Noise. Controllers shall be able to operate at 90% to 110% of nominal voltage rating and shall perform an orderly shutdown below 80% nominal voltage. Operation shall be protected against electrical noise of 5 to 120 Hz and from keyed radios up to 5 W at 1 m (3 ft).
- K. Transformer. ASC power supply shall be fused or current limiting and shall be rated at a minimum of 125% of ASC power consumption.

## 2.6 INPUT AND OUTPUT INTERFACE

- A. General. Hard-wire input and output points to BCs, AACs, ASCs, or SAs.
- B. Protection. All input points and output points shall be protected such that shorting of the point to itself, to another point, or to ground shall cause no damage to the controller. All input and output points shall be protected from voltage up to 24 V of any duration, such that contact with this voltage will cause no controller damage.

- C. Binary Inputs. Binary inputs shall allow the monitoring of ON/OFF signals from remote devices. The binary inputs shall provide a wetting current of at least 12 mA to be compatible with commonly available control devices and shall be protected against contact bounce and noise. Binary inputs shall sense dry contact closure without application of power external to the controller.
- D. Pulse Accumulation Inputs. Pulse accumulation inputs shall conform to binary input requirements and shall also accumulate up to 10 pulses per second.
- E. Analog Inputs. Analog inputs shall monitor low-voltage (0–10 Vdc), current (4–20 mA), or resistance (thermistor or RTD) signals. Analog inputs shall be compatible with and field configurable to commonly available sensing devices.
- F. Binary Outputs. Binary outputs shall provide for ON/OFF operation or a pulsed low-voltage signal for pulse width modulation control. Binary outputs on Building Controllers shall have three-position (on-off-auto) override switches and status lights. Outputs shall be selectable for normally open or normally closed operation.
- G. Analog Outputs. Analog outputs shall provide a modulating signal for the control of end devices. Outputs shall provide either a 0–10 Vdc or a 4–20 mA signal as required to properly control output devices. Analog outputs shall not drift more than 0.4% of range annually.
- H. Tri-State Outputs. Control three-point floating electronic actuators without feedback with tri-state outputs (two coordinated binary outputs). Tri-State outputs may be used to provide analog output control in zone control and terminal unit control applications such as VAV terminal units, duct-mounted heating coils, and zone dampers.
- I. System Object Capacity. The system size shall be expandable to at least twice the number of input/ output objects required for this project. Additional controllers (along with associated devices and wiring) shall be all that is necessary to achieve this capacity requirement. The operator interfaces installed for this project shall not require any hardware additions or software revisions in order to expand the system

## 2.7 POWER SUPPLIES AND LINE FILTERING

- A. Power Supplies. Control transformers shall be UL listed. Furnish Class 2 current-limiting type or furnish over-current protection in primary and secondary circuits for Class 2 service in accordance with NEC requirements. Limit connected loads to 80% of rated capacity.
  - 1. DC power supply output shall match output current and voltage requirements. Unit shall be full-wave rectifier type with output ripple of 5.0 mV maximum peak-to-peak. Regulation shall be 1.0% line and load combined, with 100-microsecond response time for 50% load changes. Unit shall have built-in over-voltage and over-current protection and shall be able to withstand 150% current overload for at least three seconds without trip-out or failure.

- a. Unit shall operate between 0°C and 50°C (32°F and 120°F). EM/RF shall meet FCC Class B and VDE 0871 for Class B and MILSTD 810C for shock and vibration.
  - b. Line voltage units shall be UL recognized and CSA listed.
2. Manufacturers or Equal.  
Functional Devices (PSC, PSH)  
IDEC (PS5R)
- B. Power Line Filtering.
1. Provide internal or external transient voltage and surge suppression for workstations and controllers. Surge protection shall have:
    - a. Dielectric strength of 1000 V minimum
    - b. Response time of 10 nanoseconds or less
    - c. Transverse mode noise attenuation of 65 dB or greater
    - d. Common mode noise attenuation of 150 dB or greater at 40–100 Hz

## 2.8 AUXILIARY CONTROL DEVICES

- A. Motorized Control Dampers, unless otherwise specified elsewhere, shall be as follow.
1. Type. Control dampers shall be the parallel or opposed-blade type as specified below or as scheduled on drawings.
    - a. Outdoor and return air mixing dampers and face-and-bypass dampers shall be parallel-blade and shall direct airstreams toward each other.
    - b. Other modulating dampers shall be opposed-blade.
    - c. Two-position shutoff dampers shall be parallel- or opposed-blade with blade and side seals.
  2. Frame. Damper frames shall be 2.38 mm (13 gauge) galvanized steel channel or 3.175 mm (1/8 in.) extruded aluminum with reinforced corner bracing.
  3. Blades. Damper blades shall not exceed 20 cm (8 in.) in width or 125 cm (48 in.) in length. Blades shall be suitable for medium velocity (10 m/s [2000 fpm]) performance. Blades shall be not less than 1.5875 mm (16 gauge).
  4. Shaft Bearings. Damper shaft bearings shall be as recommended by manufacturer for application, oil impregnated sintered bronze, or better.
  5. Seals. Blade edges and frame top and bottom shall have replaceable seals of butyl rubber or neoprene. Side seals shall be spring-loaded stainless steel. Blade seals shall leak no more than 50 L/s·m<sup>2</sup>(10 cfm per ft<sup>2</sup>) at 1000 Pa (4 in. w.g.) differential pressure. Blades shall be airfoil type suitable for wide-open face velocity of 7.5 m/s (1500 fpm).
  6. Sections. Individual damper sections shall not exceed 125 cm × 150 cm (48 in. × 60 in.). Each section shall have at least one damper actuator.
  7. Modulating dampers shall provide a linear flow characteristic where possible.
  8. Linkages. Dampers shall have exposed linkages.
  9. Manufacturers or Equal.
    - a. Ruskin (VOPSN, RCG)

## B. Electric Damper and Valve Actuators.

1. Stall Protection. Mechanical or electronic stall protection shall prevent actuator damage throughout the actuator's rotation.
2. Spring-return Mechanism. Actuators used for power-failure and safety applications shall have an internal mechanical spring-return mechanism or an uninterruptible power supply (UPS).
3. Signal and Range. Proportional actuators shall accept a 0–10 Vdc control signal. (Floating motor actuators may be substituted for proportional actuators in terminal unit applications.
4. Wiring. 24 Vac actuators shall operate on Class 2 wiring.
  - a. Running power consumption shall be <10VA
  - b. Holding power consumption shall be <6VA
5. Manual Positioning. Operators shall be able to manually position each actuator when the actuator is not powered. Non-spring-return actuators shall have an external manual gear release. Spring-return actuators with more than 7 N·m (60 in.-lb) torque capacity shall have a manual crank.
6. Manufacturers or Equal.
  - a. Siemens (GCA, GMA)

## C. Binary Temperature Devices.

1. Low-Voltage Space Thermostats. Low-voltage space thermostats shall be 24 V, bimetal-operated, with adjustable or fixed anticipation heater, concealed setpoint adjustment, 13°C–30°C (55°F–85°F) setpoint range, 1°C (2°F) maximum differential, and vented ABS plastic cover.
2. Manufacturers or Equal.  
Siemens (RAA20UW)
3. Line-Voltage Space Thermostats. Line-voltage space thermostats shall be bimetal-actuated, open-contact type or bellows-actuated, enclosed, snap-switch type or equivalent solid-state type, with heat anticipator, UL listing for electrical rating, concealed setpoint adjustment, 10°C–30°C (50°F–85°F) setpoint range, 1°C (2°F) maximum differential, and vented ABS plastic cover.
4. Manufacturers or Equal.  
Siemens (RAA20UW)
5. Low-Limit Thermostats. Low-limit airstream thermostats shall be UL listed, vapor pressure type. Element shall be at least 6 m (20 ft) long. Element shall sense temperature in each 30 cm (1 ft) section and shall respond to lowest sensed temperature. Low-limit thermostat shall be manual reset only.
6. Manufacturers or Equal.  
Johnson Controls (A11A-1C, A19EAF-2C)

## D. Temperature Sensors.

1. Type. Temperature sensors shall be Resistance Temperature Device (RTD).
2. Manufacturers or Equal.  
Johnson Controls (TE-6311M-1, TE-6311V-2, TE-6000-1)

3. Duct Sensors. Duct sensors shall be single point or averaging as shown. Averaging sensors shall be a minimum of 1.5 m (5 ft) in length per 1 m<sup>2</sup>(10 ft<sup>2</sup>) of duct cross-section.
  4. Manufacturers or Equal.  
Johnson Controls (TE-6311M-1, TE-6311V-2, TE-6315M-1)
  5. Immersion Sensors. Provide immersion sensors with a separable stainless steel well. Well pressure rating shall be consistent with system pressure it will be immersed in. Well shall withstand pipe design flow velocities.
  6. Manufacturers or Equal.  
Johnson Controls (TE-631AP-1, WZ-1000-5)
  7. Space sensors shall feature what is specified in the sequence. Space sensors shall have setpoint adjustment, override switch, display, and communication port as shown.
  8. Manufacturers or Equal.
    - a. Automated Logic (ZPS-ALC)
    - b. Johnson Controls (NS-BTB-7001)
    - c. Veris
- E. Humidity Sensors.
1. Duct and room sensors shall have a sensing range of 20%–80%.
  2. Duct sensors shall have a sampling chamber.
  3. Outdoor air humidity sensors shall have a sensing range of 20%–95% RH and shall be suitable for ambient conditions of -40°C–75°C (-40°F–170°F).
  4. Humidity sensors shall not drift more than 1% of full scale annually.
  5. Manufacturers or Equal.  
Bapi (BA/H210)
- F. Relays.
1. Control Relays. Control relays shall be plug-in type, Box mount, UL listed, and shall have dust cover and LED “energized” indicator. Contact rating, configuration, and coil voltage shall be suitable for application.
  2. Manufacturers or Equal.
    - a. Functional Devices (RIBUXC)
    - b. Veris (VBD, VMD)
  3. Time Delay Relays. Time delay relays shall be solid-state plug-in type, UL listed, and shall have adjustable time delay. Delay shall be adjustable ±100% from setpoint shown. Contact rating, configuration, and coil voltage shall be suitable for application. Provide NEMA 1 enclosure for relays not installed in local control panel.
- G. Override Timers.
1. Unless implemented in control software, override timers shall be spring-wound line voltage, UL Listed, with contact rating and configuration required by application. Provide

0–6 hour calibrated dial unless otherwise specified. Flush mount timer on local control panel face or where shown.

H. Current Transformers.

1. AC current transformers shall be UL/CSA recognized and shall be completely encased (except for terminals) in approved plastic material.
2. Transformers shall be available in various current ratios and shall be selected for  $\pm 1\%$  accuracy at 5 A full-scale output.
3. Use fixed-core transformers for new wiring installation and split-core transformers for existing wiring installation.

I. Voltage Transformers.

1. AC voltage transformers shall be UL/CSA recognized, 600 Vac rated, and shall have built-in fuse protection.
2. Transformers shall be suitable for ambient temperatures of  $4^{\circ}\text{C}$ – $55^{\circ}\text{C}$  ( $40^{\circ}\text{F}$ – $130^{\circ}\text{F}$ ) and shall provide  $\pm 0.5\%$  accuracy at 24 Vac and 5 VA load.
3. Windings (except for terminals) shall be completely enclosed with metal or plastic.

J. Power Monitors.

1. Selectable rate pulse output for kWh reading, 4–20 mA output for kW reading, N.O. alarm contact, and ability to operate with 5.0 amp current inputs or 0–0.33 volt inputs.
2. 1.0% full-scale true RMS power accuracy, +0.5 Hz, voltage input range 120–600 V, and auto range select.
3. Under voltage/phase monitor circuitry.
4. NEMA 1 enclosure.
5. Current transformers having a 0.5% FS accuracy, 600 VAC isolation voltage with 0–0.33 V output. If 0–5 A current transformer is provided, a three-phase disconnect/shorting switch assembly is required.
6. Manufacturers or Equal.  
Veris (E50, H8163)

K. Current Switches.

1. Current-operated switches shall be self-powered, split core, solid-state with adjustable trip current. Select switches to match application current and DDC system output requirements.
2. Manufacturers or Equal.  
Veris

L. Pressure Transducers.

1. Transducers shall have linear output signal and field-adjustable zero and span.
2. Transducer sensing elements shall withstand continuous operating conditions of positive or negative pressure 50% greater than calibrated span without damage.
3. Water pressure transducer diaphragm shall be stainless steel with minimum proof pressure of 1000 kPa (150 psi). Transducer shall have 0-10v output, suitable mounting provisions, and block and bleed valves.



4. Water differential pressure transducer diaphragm shall be stainless steel with minimum proof pressure of 1000 kPa (150 psi). Over-range limit (differential pressure) and maximum static pressure shall be 2000 kPa (300 psi.) Transducer shall have 0-10v output, suitable mounting provisions, and 5-valve manifold.
5. Manufacturers or Equal.
  - a. Veris (PWLX04S, PHX07S)
  - b. Bapi (ZPT-10-LR57-BB-NT-D, ZPT-10-SR75-BB-AT-D)

M. Differential Pressure Switches. Differential pressure switches (air or water service) shall be UL listed, SPDT snap-acting, pilot duty rated (125 VA minimum) and shall have scale range and differential suitable for intended application and NEMA 1 enclosure unless otherwise specified.

1. Manufacturers or Equal.  
Johnson Controls (AFS-460, P32AF-2C)

N. Occupancy Sensors. Occupancy sensors shall utilize Passive Infrared (PIR) and/or Microphonic Passive technology to detect the presence of people within a room. Sensors shall be mounted as indicated on the approved drawings. The sensor output shall be accessible by any lighting and/or HVAC controller in the system. Occupancy sensors shall be capable of being powered from the lighting or HVAC control panel, as shown on the drawings. Occupancy sensor delay shall be software adjustable through the user interface and shall not require manual adjustment at the sensor.

1. Manufacturers or Equal.
  - a. Johnson Controls (Network Sensor)
  - b. Wattstopper (DT-300)

O. Local Control Panels.

1. All indoor control cabinets shall be fully enclosed NEMA 1 construction with (hinged door) key-lock latch and removable subpanels. A single key shall be common to all field panels and subpanels.
2. Interconnections between internal and face-mounted devices shall be prewired with color-coded stranded conductors neatly installed in plastic troughs and/or tie-wrapped. Terminals for field connections shall be UL listed for 600 volt service, individually identified per control/ interlock drawings, with adequate clearance for field wiring. Control terminations for field connection shall be individually identified per control drawings.
3. Provide ON/OFF power switch with overcurrent protection for control power sources to each local panel.

## 2.9 WIRING AND RACEWAYS

A. General. Provide copper wiring, plenum cable, and raceways as specified in applicable sections of Division 26.

- B. Insulated wire shall use copper conductors and shall be UL listed for 90°C (200°F) minimum service

### PART 3 - EXECUTION

#### 3.1 EXAMINATION

- A. The contractor shall inspect the site to verify that equipment may be installed as shown. Any discrepancies, conflicts, or omissions shall be reported to the engineer for resolution before rough-in work is started.
- B. The contractor shall examine the drawings and specifications for other parts of the work. If head room or space conditions appear inadequate—or if any discrepancies occur between the plans and the contractor’s work and the plans and the work of others—the contractor shall report these discrepancies to the engineer and shall obtain written instructions for any changes necessary to accommodate the contractor’s work with the work of others. Any changes in the work covered by this specification made necessary by the failure or neglect of the contractor to report such discrepancies shall be made by—and at the expense of—this contractor.

#### 3.2 PROTECTION

- A. The contractor shall protect all work and material from damage by his/her work or employees and shall be liable for all damage thus caused.
- B. The contractor shall be responsible for his/her work and equipment until finally inspected, tested, and accepted. The contractor shall protect any material that is not immediately installed. The contractor shall close all open ends of work with temporary covers or plugs during storage and construction to prevent entry of foreign objects.

#### 3.3 COORDINATION

- A. Site
  - 1. Where the mechanical work will be installed in close proximity to, or will interfere with, work of other trades, the contractor shall assist in working out space conditions to make a satisfactory adjustment. If the contractor installs his/her work before coordinating with other trades, so as to cause any interference with work of other trades, the contractor shall make the necessary changes in his/her work to correct the condition without extra charge.
  - 2. Coordinate and schedule work with other work in the same area and with work dependent upon other work to facilitate mutual progress.
    - a. Test and Balance.
  - 3. The contractor shall furnish a single set of all tools necessary to interface to the control system for test and balance purposes.
  - 4. The contractor shall provide training in the use of these tools.

5. In addition, the contractor shall provide a qualified technician to assist in the test and balance process, until the first 5 similar units are balanced.
  6. The tools used during the test and balance process will be returned at the completion of the testing and balancing.
- B. Coordination with controls specified in other sections or divisions. Other sections and/or divisions of this specification include controls and control devices that are to be part of or interfaced to the control system specified in this section. These controls shall be integrated into the system and coordinated by the contractor as follows:
1. All communication media and equipment shall be provided as specified.
  2. Each supplier of a controls product is responsible for the configuration, programming, start up, and testing of that product to meet the sequences of operation.
  3. The contractor shall coordinate and resolve any incompatibility issues that arise between control products provided under this section and those provided under other sections or divisions of this specification.
  4. The contractor is responsible for providing all controls described in the contract documents regardless of where within the contract documents these controls are described.

### 3.4 GENERAL WORKMANSHIP

- A. Install equipment, piping, and wiring/raceway parallel to building lines (i.e. horizontal, vertical, and parallel to walls) wherever possible.
- B. Provide sufficient slack and flexible connections to allow for vibration of piping and equipment.
- C. Install equipment in readily accessible locations as defined by Chapter 1 Article 100 Part A of the National Electrical Code (NEC).
- D. Verify integrity of all wiring to ensure continuity and freedom from shorts and grounds.
- E. All equipment, installation, and wiring shall comply with industry specifications and standards for performance, reliability, and compatibility and be executed in strict adherence to local codes and standard practices.

### 3.5 FIELD QUALITY CONTROL

- A. All work, materials, and equipment shall comply with rules and regulations of applicable local, state, and federal codes and ordinances.
- B. Contractor shall continually monitor the field installation for code compliance and quality of workmanship.
- C. Contractor shall have work inspected by local and/or state authorities having jurisdiction over the work.

### 3.6 EXISTING EQUIPMENT

- A. Wiring. Interconnecting control wiring shall be removed and shall become the property of the contractor unless specifically noted or shown to be reused.
- B. Local Control Panels. Remove and deliver existing control panels to Owner.
- C. Room Thermostats. Remove and deliver existing room thermostats to Owner unless otherwise noted.
- D. Electronic Sensors and Transmitters. Remove and deliver existing sensors and transmitters to Owner.
- E. Controllers and Auxiliary Electronic Devices. Remove and deliver existing controllers and auxiliary electronic devices to Owner.
- F. Install control panels.

### 3.7 WIRING

- A. All control and interlock wiring shall comply with national and local electrical codes, and Division 26 of this specification, where the requirements of this section differ from Division 26, the requirements of Division 26 shall take precedence.
- B. All NEC Class 1 (line voltage) wiring shall be UL listed in approved raceway according to NEC and Division 26 requirements.
- C. All low-voltage wiring shall meet NEC Class 2 requirements. Low-voltage power circuits shall be subfused when required to meet Class 2 current limit.
- D. Where NEC Class 2 (current-limited) wires are in concealed and accessible locations, including ceiling return air plenums, approved cables not in raceway may be used provided that cables are UL listed for the intended application.
- E. All wiring in mechanical, electrical, or service rooms – or where subject to mechanical damage – shall be installed in raceway at levels below 10 feet.
- F. Do not install Class 2 wiring in raceways containing Class 1 wiring. Boxes and panels containing high-voltage wiring and equipment may not be used for low-voltage wiring except for the purpose of interfacing the two (e.g. relays and transformers).
- G. Do not install wiring in raceway containing tubing.
- H. Where Class 2 wiring is run exposed, wiring is to be run parallel along a surface or perpendicular to it and neatly tied at 3 m (10 ft) intervals.
- I. Where plenum cables are used without raceway, they shall be supported from or anchored to structural members. Cables shall not be supported by or anchored to ductwork, electrical raceways, piping, or ceiling suspension systems.

- J. All wiring within enclosures shall be neatly bundled and anchored to permit access and prevent restriction to devices and terminals.
- K. Maximum allowable voltage for control wiring shall be 120 V. If only higher voltages are available, the contractor shall provide step-down transformers.
- L. Install plenum wiring in sleeves where it passes through walls and floors. Maintain fire rating at all penetrations.
- M. Size of raceway and size and type of wire type shall be the responsibility of the contractor in keeping with the manufacturer's recommendations and NEC requirements, except as noted elsewhere.
- N. Include one pull string in each raceway 2.5 cm (1 in.) or larger.
- O. Use color-coded conductors throughout with conductors of different colors.
- P. Control and status relays are to be located in designated enclosures only. These enclosures include packaged equipment control panel enclosures unless they also contain Class 1 starters.
- Q. Conceal all raceways except within mechanical, electrical, or service rooms. Install raceway to maintain a minimum clearance of 15 cm (6 in.) from high-temperature equipment (e.g. steam pipes or flues).
- R. Secure raceways with raceway clamps fastened to the structure and spaced according to code requirements. Raceways and pull boxes may not be hung on flexible duct strap or tie rods. Raceways may not be run on or attached to ductwork.
- S. Adhere to this specification's Division 26 requirements where raceway crosses building expansion joints.
- T. Install insulated bushings on all raceway ends and openings to enclosures. Seal top end of vertical raceways.
- U. The contractor shall terminate all control and/or interlock wiring and shall maintain updated (as-built) wiring diagrams with terminations identified at the job site.
- V. Flexible metal raceways and liquid-tight flexible metal raceways shall not exceed 1 m (6 ft) in length and shall be supported at each end. Flexible metal raceway less than 3/8 in. electrical trade size shall not be used. In areas exposed to moisture liquid-tight, flexible metal raceways shall be used.
- W. Raceway must be rigidly installed, adequately supported, properly reamed at both ends, and left clean and free of obstructions. Raceway sections shall be joined with couplings (according to code). Terminations must be made with fittings at boxes, and ends not terminating in boxes shall have bushings installed.
- X. Wiring in the wall shall be in EMT or ENT where possible.

### 3.8 COMMUNICATION WIRING

- A. The contractor shall adhere to the items listed in the "Wiring" article in Part 3 of the specification.
- B. All cabling shall be installed in a neat and workmanlike manner. Follow manufacturer's installation recommendations for all communication cabling
- C. Do not install communication wiring in raceways and enclosures containing Class 1 or other Class 2 wiring.
- D. Maximum pulling, tension, and bend radius for the cable installation, as specified by the cable manufacturer, shall not be exceeded during installation.
- E. Contractor shall verify the integrity of the entire network following cable installation. Use appropriate test measures for each particular cable.
- F. When a cable enters or exits a building, a lightning arrestor must be installed between the lines and ground. The lightning arrestor shall be installed according to manufacturer's instructions.
- G. All runs of communication wiring shall be unspliced length when that length is commercially available.
- H. All communication wiring shall be labeled to indicate origination and destination data.
- I. Grounding of coaxial cable shall be in accordance with NEC regulations article on "Communications Circuits, Cable, and Protector Grounding."
- J. BACnet MS/TP communications wiring shall be installed in accordance with ASHRAE/ANSI Standard 135. This includes but is not limited to:
  - 1. The network shall use shielded, twisted-pair cable with characteristic impedance between 100 and 120 ohms. Distributed capacitance between conductors shall be less than 100 pF per meter (30 pF per foot.)
  - 2. The maximum length of an MS/TP segment is 1200 meters (4000 ft) with AWG 18 cable. The use of greater distances and/or different wire gauges shall comply with the electrical specifications of EIA-485.
  - 3. The maximum number of nodes per segment shall be 32, as specified in the EIA 485 standard. Additional nodes may be accommodated by the use of repeaters.
  - 4. An MS/TP EIA-485 network shall have no T connections.

### 3.9 INSTALLATION OF SENSORS

- A. Mount sensors rigidly and adequately for environment within which the sensor operates.
- B. Install sensors in accordance with the manufacturer's recommendations.
- C. Room temperature sensors shall be installed on concealed junction boxes properly supported by wall framing.

- D. All wires attached to sensors shall be sealed in their raceways or in the wall to stop air transmitted from other areas from affecting sensor readings.
- E. Sensors used in mixing plenums and hot and cold decks shall be of the averaging type. Averaging sensors shall be installed in a serpentine manner vertically across the duct. Each bend shall be supported with a capillary clip.
- F. Install outdoor air temperature sensors on north wall, complete with sun shield at designated location.

### 3.10 ACTUATORS

- A. General. Mount and link control damper actuators according to manufacturer's instructions.
  - 1. To compress seals when spring-return actuators are used on normally closed dampers, power actuator to approximately 5° open position, manually close the damper, and then tighten the linkage.
  - 2. Check operation of damper/actuator combination to confirm that actuator modulates damper smoothly throughout stroke to both open and closed positions.
  - 3. Provide all mounting hardware and linkages for actuator installation.
- B. Electric/Electronic
  - 1. Dampers: Actuators shall be direct mounted on damper shaft or jackshaft unless shown as a linkage installation. For low-leakage dampers with seals, the actuator shall be mounted with a minimum 5° travel available for tightening the damper seal. Actuators shall be mounted following manufacturer's recommendations.
  - 2. Valves: Actuators shall be connected to valves with adapters approved by the actuator manufacturer. Actuators and adapters shall be mounted following the actuator manufacturer's recommendations.

### 3.11 IDENTIFICATION OF HARDWARE AND WIRING

- A. All wiring and cabling, including that within factory-fabricated panels shall be labeled at each end within 5 cm (2 in.) of termination with control system address, termination number or other unique identifier.
- B. Permanently label or code each point of field terminal strips to show the instrument or item served.
- C. Identify control panels with a durable label.
- D. Identify all other control components with permanent labels. All plug-in components shall be labeled such that removal of the component does not remove the label.
- E. Identify room sensors related to terminal boxes or valves with labels.
- F. Identify the equipment located above the ceiling on the ceiling grid.

- G. Manufacturers' nameplates and UL or CSA labels shall be visible and legible after equipment is installed.
- H. Identifiers shall match record documents.

### 3.12 CONTROLLERS

- A. Provide a separate controller for each AHU or other HVAC system. A DDC controller may control more than one system provided that all points associated with the system are assigned to the same DDC controller. Points used for control loop reset, such as outside air or space temperature, are exempt from this requirement.
- B. Building Controllers and Custom Application Controllers shall be selected to provide the required I/O point capacity required to monitor all of the hardware points listed in the Sequences of Operation.

### 3.13 PROGRAMMING

- A. Provide sufficient internal memory for the specified sequences of operation and trend logging.
- B. Point Naming. Name points as shown on the equipment points list provided with each sequence of operation. If character limitations or space restrictions make it advisable to shorten the name. Where multiple points with the same name reside in the same controller, each point name may be customized with its associated Program Object number. For example, "Zone Temp 1" for Zone 1, "Zone Temp 2" for Zone 2.
- C. Software Programming.
  - 1. Provide programming for the system and adhere to the sequences of operation provided. All other system programming necessary for the operation of the system, but not specified in this document, also shall be provided by the contractor. Embed into the control program sufficient comment statements to clearly describe each section of the program. The comment statements shall reflect the language used in the sequences of operation. Use the appropriate technique based on the following programming types:
    - a. Text-based:
      - 1) Must provide actions for all possible situations
      - 2) Must be modular and structured
      - 3) Must be commented
    - b. Graphic-based:
      - 1) Must provide actions for all possible situations
      - 2) Must be documented



- c. Parameter-based:
  - 1) Must provide actions for all possible situations
  - 2) Must be documented.

D. Operator Interface.

- 1. Standard Graphics. Provide graphics for all mechanical systems and floor plans of the building. This includes each chilled water system, hot water system, chiller, boiler, air handler, and all terminal equipment. Point information on the graphic displays shall dynamically update. Show on each graphic all input and output points for the system. Also show relevant calculated points such as setpoints. As a minimum, show on each equipment graphic the input and output points and relevant calculated points..
- 2. The contractor shall provide all the labor necessary to install, initialize, start up, and troubleshoot all operator interface software and its functions as described in this section. This includes any operating system software, the operator interface database, and any third-party software installation and integration required for successful operation of the operator interface.

### 3.14 CONTROL SYSTEM CHECKOUT AND TESTING

- A. Startup Testing. All testing listed in this article shall be performed by the contractor and shall make up part of the necessary verification of an operating control system. This testing shall be completed before the owner's representative is notified of the system demonstration.
  - 1. The contractor shall furnish all labor and test apparatus required to calibrate and prepare for service of all instruments, controls, and accessory equipment furnished under this specification.
  - 2. Verify that all control wiring is properly connected and free of all shorts and ground faults. Verify that terminations are tight.
  - 3. Enable the control systems and verify calibration of all input devices individually. Perform calibration procedures according to manufacturers' recommendations.
  - 4. Verify that all binary output devices (relays, solenoid valves, two-position actuators and control valves, magnetic starters, etc.) operate properly and that the normal positions are correct.
  - 5. Verify that all analog output devices (I/Ps, actuators, etc.) are functional, that start and span are correct, and that direction and normal positions are correct. The contractor shall check all control valves and automatic dampers to ensure proper action and closure. The contractor shall make any necessary adjustments to valve stem and damper blade travel.
  - 6. Verify that the system operation adheres to the sequences of operation. Simulate and observe all modes of operation by overriding and varying inputs and schedules. Tune all DDC loops.
  - 7. Alarms and Interlocks:
    - a. Check each alarm separately by including an appropriate signal at a value that will trip the alarm.
    - b. Interlocks shall be tripped using field contacts to check the logic, as well as to ensure that the fail-safe condition for all actuators is in the proper direction.

- c. Interlock actions shall be tested by simulating alarm conditions to check the initiating value of the variable and interlock action.

### 3.15 CONTROL SYSTEM DEMONSTRATION AND ACCEPTANCE

#### A. Demonstration.

1. Prior to acceptance, the control system shall undergo a series of performance tests to verify operation and compliance with this specification. These tests shall occur after the Contractor has completed the installation, started up the system, and performed his/her own tests.
2. The tests described in this section are to be performed in addition to the tests that the contractor performs as a necessary part of the installation, start-up, and debugging process and as specified in the "Control System Checkout and Testing" article in Part 3 of this specification. The engineer will be present to observe and review these tests. The engineer shall be notified at least 10 days in advance of the start of the testing procedures.
3. The demonstration process shall follow that approved in Part 1, "Submittals." The approved checklists and forms shall be completed for all systems as part of the demonstration.
4. The contractor shall provide at least two persons equipped with two-way communication and shall demonstrate actual field operation of each control and sensing point for all modes of operation including day, night, occupied, unoccupied, fire/smoke alarm, seasonal changeover, and power failure modes. The purpose is to demonstrate the calibration, response, and action of every point and system. Any test equipment required to prove the proper operation shall be provided by and operated by the contractor.
5. As each control input and output is checked, a log shall be completed showing the date, technician's initials, and any corrective action taken or needed.
6. Demonstrate compliance with Part 1, "System Performance."
7. Demonstrate compliance with sequences of operation through all modes of operation.
8. Demonstrate complete operation of operator interface.
9. Additionally, the following items shall be demonstrated:
  - a. DDC loop response. The contractor shall supply trend data output in a graphical form showing the step response of each DDC loop. The test shall show the loop's response to a change in set point, which represents a change of actuator position of at least 25% of its full range. The sampling rate of the trend shall be from 10 seconds to 3 minutes, depending on the speed of the loop. The trend data shall show for each sample the set point, actuator position, and controlled variable values. Any loop that yields unreasonably under-damped or over-damped control shall require further tuning by the Contractor.
  - b. Demand limiting. The contractor shall supply a trend data output showing the action of the demand limiting algorithm. The data shall document the action on a minute-by-minute basis over at least a 30-minute period. Included in the trend shall be building kW, demand limiting set point, and the status of sheddable equipment outputs.
  - c. Optimum start/stop. The contractor shall supply a trend data output showing the capability of the algorithm. The change-of-value or change-of-state trends shall include the output status of all optimally started and stopped equipment, as well as temperature sensor inputs of affected areas.

- d. Interface to the building fire alarm system.
  - e. Operational logs for each system that indicate all set points, operating points, valve positions, mode, and equipment status shall be submitted to the architect/engineer. These logs shall cover three 48-hour periods and have a sample frequency of not more than 10 minutes. The logs shall be provided in both printed and disk formats.
10. Any tests that fail to demonstrate the operation of the system shall be repeated at a later date. The contractor shall be responsible for any necessary repairs or revisions to the hardware or software to successfully complete all tests.
- B. Acceptance.
- 1. All tests described in this specification shall have been performed to the satisfaction of both the engineer and owner prior to the acceptance of the control system as meeting the requirements of completion. Any tests that cannot be performed due to circumstances beyond the control of the contractor may be exempt from the completion requirements if stated as such in writing by the engineer. Such tests shall then be performed as part of the warranty.
  - 2. The system shall not be accepted until all forms and checklists completed as part of the demonstration are submitted and approved as required in Part 1, "Submittals."

### 3.16 CLEANING

- A. The contractor shall clean up all debris resulting from his/her activities daily. The contractor shall remove all cartons, containers, crates, etc., under his/her control as soon as their contents have been removed. Waste shall be collected and placed in a designated location.
- B. At the completion of work in any area, the contractor shall clean all work, equipment, etc., keeping it free from dust, dirt, and debris, etc.
- C. At the completion of work, all equipment furnished under this section shall be checked for paint damage, and any factory-finished paint that has been damaged shall be repaired to match the adjacent areas. Any cabinet or enclosure that has been deformed shall be replaced with new material and repainted to match the adjacent areas.

### 3.17 TRAINING

- A. Training shall consist of two sessions each 4 hours long.
- B. Provide training for a designated staff of Owner's representatives. Training shall be provided via self-paced training, web-based or computer-based training, classroom training, or a combination of training methods.

- C. Training shall enable students to accomplish the following objectives.
1. Day-to-day Operators:
    - a. Proficiently operate the system
    - b. Understand control system architecture and configuration
    - c. Understand DDC system components
    - d. Understand system operation, including DDC system control and optimizing routines (algorithms)
    - e. Operate the workstation and peripherals
    - f. Log on and off the system
    - g. Access graphics, point reports, and logs
    - h. Adjust and change system set points, time schedules, and holiday schedules
    - i. Recognize malfunctions of the system by observation of the printed copy and graphical visual signals
    - j. Understand system drawings and Operation and Maintenance manual
    - k. Understand the job layout and location of control components
    - l. Access data from DDC controllers and ASCs
    - m. Operate portable operator's terminals
  2. Advanced Operators:
    - a. Make and change graphics on the workstation
    - b. Create, delete, and modify alarms, including annunciation and routing of these
    - c. Create, delete, and modify point trend logs and graph or print these both on an ad-hoc basis and at user-definable time intervals
    - d. Create, delete, and modify reports
    - e. Add, remove, and modify system's physical points
    - f. Create, modify, and delete programming
    - g. Add panels when required
    - h. Add operator interface stations
    - i. Create, delete, and modify system displays, both graphical and others
    - j. Perform DDC system field checkout procedures
    - k. Perform DDC controller unit operation and maintenance procedures
    - l. Perform workstation and peripheral operation and maintenance procedures
    - m. Perform DDC system diagnostic procedures
    - n. Configure hardware including PC boards, switches, communication, and I/O points
    - o. Maintain, calibrate, troubleshoot, diagnose, and repair hardware
    - p. Adjust, calibrate, and replace system components
  3. System Managers/Administrators:
    - a. Maintain software and prepare backups
    - b. Interface with job-specific, third-party operator software
    - c. Add new users and understand password security procedures
- D. Organize the training into sessions or modules for the three levels of operators listed above. (Day-to-Day Operators, Advanced Operators, System Managers and Administrators). Students will receive one or more of the training packages, depending on knowledge level required.

- E. Provide course outline and materials according to the "Submittals" article in Part 1 of this specification. Provide one copy of training material per student.
- F. The instructor(s) shall be factory-trained and experienced in presenting this material.
- G. Classroom training shall be done using a network of working controllers representative of installed hardware.

### 3.18 CONTROLS COMMUNICATION PROTOCOL

- A. General. The electronic controls packaged with this equipment shall communicate with the building direct digital control (DDC) system. The DDC system shall communicate with these controls to read the information and change the control setpoints as shown in the points list, sequences of operation, and control schematics. The information to be communicated between the DDC system and these controls shall be in the standard object format as defined in ANSI/ASHRAE Standard 135 (BACnet). Controllers shall communicate with other BACnet objects on the internetwork using the Read (Execute) Property service.
- B. Distributed Processing. The controller shall be capable of stand-alone operation and shall continue to provide control functions if the network connection is lost.
- C. I/O Capacity. The controller shall contain sufficient I/ O capacity to control the target system.
- D. The Controller shall have a physical connection for a laptop computer or a portable operator's tool.
- E. Environment. The hardware shall be suitable for the anticipated ambient conditions.
- F. Serviceability. Provide diagnostic LEDs for power, communication, and processor. All wiring connections shall be made to field removable, modular terminal strips or to a termination card connected by a ribbon cable.
- G. Memory. The Controller shall maintain all BIOS and programming information in the event of a power loss for at least 30 days.
- H. Power. Controller shall be able to operate at 90% to 110% of nominal voltage rating.
- I. Transformer. Power supply for the Controller must be rated at minimum of 125% of ASC power consumption and shall be fused or current limiting type.

### 3.19 START-UP AND CHECKOUT PROCEDURES

- A. Start up, check out, and test all hardware and software and verify communication between all components.

1. Verify that all control wiring is properly connected and free of all shorts and ground faults. Verify that terminations are tight.
2. Verify that all analog and binary input/output points read properly.
3. Verify alarms and interlocks.
4. Verify operation of the integrated system.

### 3.20 SEQUENCES OF OPERATIONS:

- A. Run Conditions - Scheduled: The unit shall run according to a user definable time schedule in the following modes:
1. Occupied Mode: The unit shall maintain
    - a. A 74°F (adj.) cooling setpoint
    - b. A 70°F (adj.) heating setpoint.
  2. Unoccupied Mode (night setback): The unit shall maintain
    - a. A 85°F (adj.) cooling setpoint.
    - b. A 55°F (adj.) heating setpoint.
- B. Alarms shall be provided as follows:
1. High Zone Temp: If the zone temperature is greater than the cooling setpoint by a user definable amount (adj.).
  2. Low Zone Temp: If the zone temperature is less than the heating setpoint by a user definable amount (adj.).
- C. Demand Limiting - Zone Setpoint Optimization: To lower power consumption, the zone setpoints shall automatically relax when the facility power consumption exceeds definable thresholds. The amount of relaxation shall be individually configurable for each zone. The zone setpoints shall automatically return to their previous settings when the facility power consumption drops below the thresholds.
- D. Zone Setpoint Adjust: The occupant shall be able to adjust the zone temperature heating and cooling setpoints at the zone sensor.
- E. Zone Optimal Start: The unit shall use an optimal start algorithm for morning start-up. This algorithm shall minimize the unoccupied warm-up or cool-down period while still achieving comfort conditions by the start of scheduled occupied period.
- F. Zone Unoccupied Override: A timed local override control shall allow an occupant to override the schedule and place the unit into an occupied mode for an adjustable period of time. At the expiration of this time, control of the unit shall automatically return to the schedule.
- G. Occupied:

1. When zone temperature is greater than its cooling setpoint, the zone damper shall modulate between the minimum occupied airflow (adj.) and the maximum cooling airflow (adj.) until the zone is satisfied.
  2. When the zone temperature is between the cooling setpoint and the heating setpoint, the zone damper shall maintain the minimum required zone ventilation (adj.).
  3. When zone temperature is less than its heating setpoint, the controller shall enable heating to maintain the zone temperature at its heating setpoint. Additionally, if warm air is available from the AHU, the zone damper shall modulate between the minimum occupied airflow (adj.) and the maximum heating airflow (adj.) until the zone is satisfied.
- H. Unoccupied:
1. When the zone is unoccupied the zone damper shall control to its minimum unoccupied airflow (adj.).
  2. When the zone temperature is greater than its cooling setpoint, the zone damper shall modulate between the minimum unoccupied airflow (adj.) and the maximum cooling airflow (adj.) until the zone is satisfied.
  3. When zone temperature is less than its unoccupied heating setpoint, the controller shall enable heating to maintain the zone temperature at the setpoint. Additionally, if warm air is available from the AHU, the zone damper shall modulate between the minimum unoccupied airflow (adj.) and the auxiliary heating airflow (adj.) until the zone is satisfied.
- I. Fan Control
1. Parallel fan-powered units: the fan is energized upon a call for heating. The parallel fan is turned off when the space temperature rises above the fan on/off point (active heating setpoint plus fan offset) plus 0.5°F.
  2. ECM fan speed shall be adjustable via the BAS.
  3. Fan Status: The controller shall monitor the fan status.
- J. CO2 Demand Control Ventilation (variable occupancy spaces – conference rooms):
1. When the zone CO2 sensor is below 900 ppm (adj.), the system will have the terminal damper at minimum position and modulate the damper based on its PID temperature control algorithm to maintain desired zone temperature set-points.
  2. If the CO2 level at the zone exceeds its set point the system will begin to modulate the damper using a PID control loop. When the CO2 level set point is reached the box will stop modulation and begin back toward minimum position.
- K. Electric Reheating Stage: The controller shall measure the zone temperature and stage the reheating to maintain its setpoint. To prevent short cycling, the stage shall have a user definable (adj.) minimum runtime. The reheating shall be enabled whenever:
1. Outside air temperature is less than 65°F (adj.).
  2. AND the zone temperature is below setpoint.
  3. AND sufficient airflow is provided.
- L. Rooms with electric baseboard: Provide control of baseboard in sync with the VAV air terminals; with the air system being the primary heating. Above 35F the baseboard shall be disabled.

M. Discharge Air Temperature: The controller shall monitor the discharge air temperature. Alarms shall be provided as follows:

1. High Discharge Air Temp: If the discharge air temperature is greater than 120°F (adj.).
2. Low Discharge Air Temp: If the discharge air temperature is less than 40°F (adj.).

N. Points List

Point Name	Hardware Points				Software Points						Show On Graphic
	AI	A O	BI	BO	AV	BV	Loop	Sched	Trend	Alarm	
Zone Temp	x								x		x
Zone Setpoint Adjust	x										x
Airflow	x								x		x
Discharge Air Temp	x								x		x
Zone Damper		x									x
Zone Override			x						x		x
Fan Status			x						x		x
Fan Speed		x									
Fan Start/Stop				x							x
Reheating		x							x		x
Airflow Setpoint					x				x		x
Heating Mode						x			x		
Schedule								x			
Baseboard Heat					x						x
Heating Setpoint									x		x
Cooling Setpoint									x		x
High Zone Temp										x	
Low Zone Temp										x	
High Discharge Air Temp										x	
Low Discharge Air Temp										x	
Fan Failure										x	
Fan in Hand										x	
Fan Runtime Exceeded										x	

END OF SECTION 230900



## SECTION 233113 - DUCTWORK

### PART 1 - GENERAL

#### 1.1 RELATED DOCUMENTS

- A. Drawings and general provisions of the Contract, including General and Supplementary Conditions and Division 1 Specification Sections, apply to this Section.
- B. Related Sections include the following:
  - 1. Division 8 for Access Doors
  - 2. Division 23 Section "Common Work Results for Mechanical"
  - 3. Division 23 Section "Mechanical Insulation"
  - 4. Division 23 Section "Air Terminals"
  - 5. Division 23 Section "Diffusers, Registers, and Grilles."
  - 6. Division 23 Control Section
  - 7. Division 23 Section "Testing, Adjusting, and Balancing".

#### 1.2 SUMMARY

- A. This Section includes ducts and accessories.

#### 1.3 SYSTEM DESCRIPTION

- A. Drawings show the general layout of ductwork and accessories but do not show all required fittings and offsets that may be necessary to connect ducts to equipment, diffusers, grilles, etc., and to coordinate with other trades. Fabricate ductwork based on field measurements. Provide all necessary fittings and offsets. Coordinate with other trades for space available and relative location of HVAC equipment and accessories on ceiling grid. Duct sizes on the drawings are inside dimensions, which may be altered by Contractor to other dimensions with the same air handling characteristics where necessary to avoid interferences and clearance difficulties.
- B. The contractor must comply with the enclosed specification in its entirety. If on inspections, the engineer finds changes have been made without prior written approval, the contractor will make the applicable changes to comply with this specification, at the contractor's expense.
- C. At the discretion of the engineer, sheet metal gauges, and reinforcing may be randomly checked to verify all duct construction is in compliance.

#### 1.4 PERFORMANCE REQUIREMENTS

- A. Delegated Duct Design: Duct construction, including sheet metal thicknesses, seam and joint construction, reinforcements, and hangers and supports, shall comply with SMACNA's "HVAC

Duct Construction Standards - Metal and Flexible" and performance requirements and design criteria indicated in "Duct Schedule" Article.

- B. Structural Performance: Duct hangers and supports and seismic restraints shall withstand the effects of gravity and seismic loads and stresses within limits and under conditions described in SMACNA's "HVAC Duct Construction Standards - Metal and Flexible", ASCE/SEI 7, and SMACNA's "Seismic Restraint Manual: Guidelines for Mechanical Systems."
- C. Airstream Surfaces: Surfaces in contact with the airstream shall comply with requirements in ASHRAE 62.1. Exception: Sheet metal surfaces and fasteners.

## 1.5 ACTION SUBMITTALS

- A. Product Data: For each type of the following products:
  - 1. Liners and adhesives.
  - 2. Sealants and gaskets.
- B. Shop Drawings:
  - 1. Fabrication, assembly, and installation, including plans, elevations, sections, components, and attachments to other work.
  - 2. Factory- and shop-fabricated ducts and fittings.
  - 3. Fittings.
  - 4. Reinforcement and spacing.
  - 5. Seam and joint construction.
  - 6. Penetrations through fire-rated and other partitions.
  - 7. Equipment installation based on equipment being used on Project.
  - 8. Hangers and supports, including methods for duct and building attachment, seismic restraints, and vibration isolation.
- C. Delegated-Design Submittal:
  - 1. Sheet metal thicknesses.
  - 2. Joint and seam construction and sealing.
  - 3. Reinforcement details and spacing.
  - 4. Materials, fabrication, assembly, and spacing of hangers and supports.
- D. Ductwork Specialties Product Data; provide for the following:
  - 1. Sealant
  - 2. Duct Liner
  - 3. Duct-mounted access doors and panels.
  - 4. Flexible ducts.
  - 5. Manual-volume dampers: Damper manufacturer's printed application and performance data including pressure, velocity and temperature limitations shall be submitted for approval.
  - 6. Life Safety dampers: Provide complete submittal information (including installation instructions) and the manufacturer's certification of compliance with these specifications

for approval prior to bidding. Contractor shall include damper manufacturer's Installation Instructions as part of the submittal. These instructions shall describe the applicable requirements for damper sleeve thickness, retaining angles, and methods of attachment, duct-to-sleeve connections, preparation of wall or floor openings, and all other requirements to provide an installation equivalent to that tested by the damper manufacturer during the UL Standard 555 qualification procedures. Contractor shall detail any proposed installations that deviate from these manufacturer's instructions and explain the needed deviations.

#### 1.6 CLOSEOUT SUBMITTALS

- A. Operation and Maintenance Data: For air duct accessories to include in operation and maintenance manuals.
- B. Record Drawings: Indicate actual routing, fitting details, reinforcement, support, and installed accessories and devices.

#### 1.7 APPLICABLE PUBLICATIONS

- A. The publications listed below form a part of this specification to the extent referenced. The publications are referenced in the text by the basic designation only.
- B. ASHRAE Compliance: Applicable requirements in ASHRAE 62.1, Section 5 - "Systems and Equipment" and Section 7 - "Construction and System Start-up."
- C. National Fire Protection Association (NFPA): 90A: Standard for the Installation of Air Conditioning and Ventilating Systems
- D. Sheet Metal and Air Conditioning Contractors National Association (SMACNA): 3rd Edition: 2005 HVAC Duct Construction Standards, Metal and Flexible

#### 1.8 DELIVERY, STORAGE, AND HANDLING

- A. Deliver sealant and fire stopping materials to site in original unopened containers or bundles with labels indicating manufacturer, product name and designation, color, expiration period for use, pot life, curing time, and mixing instructions for multi-component materials.
- B. Deliver, store and handle materials according to manufacturer's written recommendations.
- C. All ductwork, equipment, and fittings delivered and stored on the job site must be capped to prevent the entry of moisture, construction dust or other debris.

## PART 2 - PRODUCTS

## 2.1 SHEET METAL MATERIALS

- A. General Material Requirements: Comply with SMACNA's "HVAC Duct Construction Standards - Metal and Flexible" for acceptable materials, material thicknesses, and duct construction methods unless otherwise indicated. Sheet metal materials shall be free of pitting, seam marks, roller marks, stains, discolorations, and other imperfections.
- B. Galvanized Sheet Steel: Comply with ASTM A 653/A 653M. Galvanized Coating Designation: G60 or G90 as indicated. Finishes for Surfaces Exposed to View: Mill phosphatized.
- C. Reinforcement Shapes and Plates: ASTM A-36/A-36M, steel plates, shapes, and bars; black and galvanized.
- D. Tie Rods: Galvanized steel, 1/4-inch minimum diameter for lengths 36 inches or less; 3/8-inch minimum diameter for lengths longer than 36 inches.

## 2.2 SINGLE-WALL RECTANGULAR DUCTS AND FITTINGS

- A. General Fabrication Requirements: Comply with SMACNA's "HVAC Duct Construction Standards - Metal and Flexible" based on indicated static-pressure class unless otherwise indicated.
- B. Transverse Joints: Select joint types and fabricate according to SMACNA's "HVAC Duct Construction Standards - Metal and Flexible," Figure 2-1, "Rectangular Duct/Transverse Joints," for static-pressure class, applicable sealing requirements, materials involved, duct-support intervals, and other provisions in SMACNA's "HVAC Duct Construction Standards - Metal and Flexible."
- C. Longitudinal Seams: Select seam types and fabricate according to SMACNA's "HVAC Duct Construction Standards - Metal and Flexible," Figure 2-2, "Rectangular Duct/Longitudinal Seams," for static-pressure class, applicable sealing requirements, materials involved, duct-support intervals, and other provisions in SMACNA's "HVAC Duct Construction Standards - Metal and Flexible."
- D. Cross Breaking or Cross Beading: Cross break or cross bead duct sides 19 inches and larger and 0.0359 inch thick or less, with more than 10 sq. ft. of un-braced panel area, unless ducts are lined. All large ducts must be braced as required to prevent drumming.
- E. Elbows, Transitions, Offsets, Branch Connections, and Other Duct Construction: Select types and fabricate according to SMACNA's "HVAC Duct Construction Standards - Metal and Flexible," Chapter 4, "Fittings and Other Construction," for static-pressure class, applicable sealing requirements, materials involved, duct-support intervals, and other provisions in SMACNA's "HVAC Duct Construction Standards - Metal and Flexible."

1. Fig. 2-3 Rectangular Elbows: Type RE2 square throat with vanes, Type RE1 radius (1.5W minimum), or Type RE5 dual radius. Square throat is not allowed.
2. Vane support in elbows: Fig 2-4. Turning vanes shall be Harper double wall turning vanes fabricated from the same material as the duct. Mounting rails shall have friction insert tabs that align the vanes automatically. Tab spacing shall be as specified in Figure 2-3 of the 1995 SMACNA Manual, "HVAC Duct Construction Standards, Metal & Flexible" Second Edition standard. Rail systems with non-standard tab spacing shall not be accepted. Due to tensile loading, vanes shall be capable of supporting 250 pounds when secured according to the manufacturer's instructions.
3. Fig. 2-5 Rectangular Divided Flow Branches: Type 1, Type 2, Type 4A, or 4B.
4. Fig. 2-6 Branch Connections: 45-degree entry, 45-degree lead-in, bell-mouth or spin-in (single diffuser supply only).
5. Fig. 2-7 Offsets and Transitions. Use gradual offsets as shown, 90-degree offsets shall be avoided.

### 2.3 ROUND DUCT FABRICATION

- A. Fabricate supply ducts of galvanized steel according to SMACNA's "HVAC Duct Construction Standards--Metal and Flexible" latest edition.
- B. Longitudinal Seams: Select seam types and fabricate according to SMACNA's "HVAC Duct Construction Standards - Metal and Flexible," Figure 3-2, "Round Duct Longitudinal Seams," for static-pressure class, applicable sealing requirements, materials involved, duct-support intervals, and other provisions in SMACNA's "HVAC Duct Construction Standards - Metal and Flexible."
  1. Concealed Round Ducts: Shall be longitudinal Grooved Seam Flat lock (RL-5 seam) at 2-inch wg construction.
  2. Snap lock seams shall not be used for this project.
- C. Transverse Joints: Select joint types and fabricate according to SMACNA's "HVAC Duct Construction Standards - Metal and Flexible," Figure 3-1, "Round Duct Transverse Joints," for static-pressure class, applicable sealing requirements, materials involved, duct-support intervals, and other provisions in SMACNA's "HVAC Duct Construction Standards - Metal and Flexible."

### 2.4 HANGERS AND SUPPORTS

- A. Hanger Rods: Cadmium-plated steel rods and nuts.
- B. Strap and Rod Sizes: Comply with SMACNA's "HVAC Duct Construction Standards - Metal and Flexible," Table 5-1, "Rectangular Duct Hangers Minimum Size," and Table 5-2, "Minimum Hanger Sizes for Round Duct."
- C. Steel Cables: Galvanized steel complying with ASTM A-603. Steel Cable End Connections: Cadmium-plated steel assemblies with brackets, swivel, and bolts designed for duct hanger service; with an automatic-locking and clamping device.

- D. Duct Attachments: Sheet metal screws, blind rivets, or self-tapping metal screws; compatible with duct materials.

## 2.5 SEALANT MATERIALS

- A. Joint Sealant/Mastic: Shall be flexible, water-based, adhesive sealant designed for use in all pressure duct systems. After curing, it shall be resistant to ultraviolet light and shall prevent the entry of water, air and moisture into the duct system. Sealer shall be UL 723 and UL 181 listed and meet NFPA 90A requirements.
  - 1. Maximum 5 flame spread and 0 smoke-developed (ASTM E-84 Tunnel Test).
  - 2. Generally provide liquid sealant for low clearance slip joints and heavy, permanently elastic, mastic type where clearances are larger.
  - 3. Resistance to mold, mildew and water: Excellent
  - 4. Color: Gray
  - 5. Duct sealant/mastic shall meet requirement for "LEED IEQ Credit 4.1: Low Emitting Materials: Adhesive and Sealant". ITW TACC Miracle Kingco water-based sealants, or approved equal.
- B. Flange Gaskets: Butyl rubber, neoprene, or EPDM polymer with polyisobutylene plasticizer.
- C. Round Duct Joint O-Ring Seals: Seal shall provide maximum leakage class of 3 cfm/100 sq. ft. at 1-inch wg and shall be rated for 10-inch wg static-pressure class, positive or negative. Double-lipped, EPDM O-ring seal, mechanically fastened to factory-fabricated couplings and fitting spigots.

## 2.6 FITTINGS

- A. Tees, Laterals, and Conical Tees: Use 45 degree; fabricate to comply with SMACNA's "HVAC Duct Construction Standards--Metal and Flexible," with metal thicknesses specified for longitudinal seam straight duct.
- B. Diverging-Flow Fittings: Fabricate with a reduced entrance to branch taps with no excess material projecting from body onto branch tap entrance.
- C. Elbows: Diameters 3 through 8 inches shall be two-section die stamped; all others shall be gored construction, maximum 18 degree angle, with all seams continuously welded or standing seam. Coat galvanized areas of fittings damaged by welding with corrosion resistant aluminum paint or galvanized repair compound.

## 2.7 DUCT LINER

- A. Manufacturers: Subject to compliance with requirements, provide products by one of the following:
  - 1. Certainteed Toughgard-2
  - 2. Knauf Textile Duct Liner with Hydroshield Technology

3. John Mansville Linacousic RC
  4. McGill Airflow
- B. All products shall be certified by Greenguard Environmental Institute; independent testing of products for emissions of respirable particles and Volatile Organic Compounds (VOC's), including formaldehyde and other specific product-related pollutants. Greenguard provides independent, third-party certification of IAQ performance. Certification is based upon criteria used by EPA, OSHA and WHO.
- C. Duct dimensions shown on the contract drawings are for airflow area. When ducts are acoustically lined, their dimensions shall be increased as necessary.
- D. Liner Thickness: General duty: 1 inch (R4.2)
- E. Fibrous-Glass Duct Liner :All ducts indicated on drawings, shall be insulated with duct liner meeting the requirements of ASTM C1071 and the additional following requirements:
1. Have a liquid water repellency rating not less than 4 when tested in accordance with INDA IST 80.6.
  2. Have a potential heat value not exceeding 3500 BTU/lb. when tested in accordance with NFPA 259 and meeting the classification of "Limited Combustible" as defined by NFPA 90A.
  3. Maximum rated velocity not less than 6000 FPM when tested in accordance with ASTM C 1071.
  4. Antimicrobial Erosion-Resistant Coating: Apply to the surface of the liner that will form the interior surface of the duct to act as a moisture repellent and erosion-resistant coating. Antimicrobial compound shall be tested for efficacy by an NRTL and registered by the EPA for use in HVAC systems. Resistant to microbial growth using a "no growth criteria" when tested in accordance with ASTM C 1138, G 21 and G22.
  5. Duct liner adhesive sealants shall meet requirement for "LEED IEQ Credit 4.1: Low Emitting Materials: Adhesive and Sealant". ITW TACC PF-101/PF-102, or approved equal.
- F. Shop Application of Duct Liner: Comply with SMACNA's "HVAC Duct Construction Standards - Metal and Flexible," Figure 7-11, "Flexible Duct Liner Installation."
1. Adhere a single layer of indicated thickness of duct liner with at least 90 percent adhesive coverage at liner contact surface area. Attaining indicated thickness with multiple layers of duct liner is prohibited.
  2. Apply adhesive to transverse edges of liner facing upstream that do not receive metal nosing.
  3. Butt transverse joints without gaps, and coat joint with adhesive.
  4. Fold and compress liner in corners of rectangular ducts or cut and fit to ensure butted-edge overlapping.
  5. Do not apply liner in rectangular ducts with longitudinal joints, except at corners of ducts, unless duct size and dimensions of standard liner make longitudinal joints necessary.
  6. Apply adhesive coating on longitudinal seams in ducts with air velocity of 2500 fpm.
  7. Secure liner with mechanical fasteners 4 inches from corners and at intervals not exceeding 12 inches transversely; at 3 inches from transverse joints and at intervals not exceeding 18 inches longitudinally.

8. Secure transversely oriented liner edges facing the airstream with metal nosings that have either channel or "Z" profiles or are integrally formed from duct wall. Fabricate edge facings at the following locations:
  - a. Fan discharges.
  - b. Intervals of lined duct preceding unlined duct.
  - c. Upstream edges of transverse joints in ducts where air velocities are higher than 2500 fpm or where indicated.

## 2.8 MANUAL-VOLUME DAMPERS

- A. Manual balancing dampers meeting the following specifications shall be furnished and installed on all branch ducts and where shown on plans. Testing and ratings to be in accordance with AMCA Standard 500-D.
- B. Single-Blade Rectangular Dampers shall consist of: an 18 ga. galvanized steel frame with 3-1/2 in. depth; blades fabricated from 20 ga. galvanized steel; integral 1/2 in. diameter axles. Damper suitable for pressures to 1.0 in. wg, velocities to 2000 fpm and temperatures to 180°F. Basis of design is Greenheck model MBD-10.
- C. Multi-Blade Rectangular Dampers shall consist of: a 16 ga. galvanized steel hat channel frame with 5 in. depth; triple V type blades fabricated from 16 ga. galvanized steel; 1/2 in. dia. plated steel axles; external (out of the airstream) blade-to-blade linkage. Damper suitable for pressures to 4.0 in. w.g. (996 Pa), velocities to 2000 fpm and temperatures to 180°F. Basis of design is Greenheck model MBD15.
- D. Round dampers shall consist of: a 20 ga. galvanized steel frame with 6 in. depth; blades fabricated from 20 ga. galvanized steel; 3/8 in. square plated steel axles turning in acetal bearings. Damper suitable for pressures to 1.0 in. wg, velocities to 2000 fpm and temperatures to 180°F. Basis of design is Greenheck model MBDR50.

## 2.9 FIRE DAMPERS

- A. Manufacturers: Subject to compliance with requirements, provide products by one of the following:
  1. Air Balance Inc.
  2. Cesco Products
  3. Greenheck Fan Corporation.
  4. METALAIRE, Inc.
  5. Nailor Industries Inc.
  6. Prefco
  7. Ruskin Company.
- B. Type: Static; rated and labeled according to UL 555S by an NRTL.
- C. Fire Rating: 1-1/2 hours.



- D. Frame: Curtain type with blades outside airstream except when located behind grille where blades may be inside airstream; fabricated with roll-formed, 0.034-inch- thick galvanized steel; with mitered and interlocking corners.
- E. Mounting Sleeve: Factory-provided.
- F. Mounting Orientation: Vertical or horizontal as indicated.
- G. Blades: Roll-formed, interlocking, 0.034-inch- thick, galvanized sheet steel. In place of interlocking blades, use full-length, 0.034-inch- thick, galvanized-steel blade connectors.
- H. Horizontal Dampers: Include blade lock and stainless-steel closure spring.
- I. Heat-Responsive Device: Replaceable, 165°F rated, fusible links.

#### 2.10 DUCT-MOUNTED ACCESS DOORS

- A. Manufacturers: Subject to compliance with requirements, provide products by one of the following:
  - 1. Ductmate Industries, Inc.
  - 2. Greenheck Fan Corporation.
  - 3. McGill Air Flow LLC.
  - 4. Nailor Industries Inc.
  - 5. Durodyne
  - 6. Cesco
  - 7. Buckley
- B. Duct-Mounted Access Doors: Fabricate access panels according to SMACNA's "HVAC Duct Construction Standards - Metal and Flexible"; Figures 2-10, "Duct Access Doors and Panels," and 2-11, "Access Panels - Round Duct."
  - 1. Door: Double wall, rated for up to 4.5" static pressure. Door panel filled with 1" fiberglass insulation; ¾ lb. density. Hinges and Latches: 1-by-1-inch continuous piano hinge and cam latches. Fabricate doors airtight and suitable for duct pressure class.
  - 2. Frame: Galvanized sheet steel, with bend-over tabs.
  - 3. Provide 1/8" thick neoprene gaskets.
  - 4. Locks: Access doors less than 16 Inches Square: Two cam locks. Doors over 16" shall have four locks.

#### 2.11 FLEXIBLE CONNECTORS

- A. Provide for all air moving equipment. General: Flame-retarded or noncombustible fabrics, coatings, and adhesives complying with UL 181, Class 0 or 1. Factory fabricated with a strip of fabric 3-1/2 inches wide attached to two strips of 2-3/4-inch- wide, 0.028-inch- thick, galvanized, sheet steel or 0.032-inch aluminum sheets. Select metal compatible with connected ducts. Duro-Dyne, Hardcast, or approved equal.

- B. Indoor Flexible Connector Fabric: Glass fabric double coated with polychloroprene or neoprene. Minimum Weight: 26 oz. /sq. yd. Tensile Strength: 480 lbf/inch in the warp, and 360 lbf/inch in the filling.

## 2.12 FLEXIBLE DUCTS

- A. General: Comply with UL 181, Class 0 Or 1. Flame Spread: Less than 25; Smoke Developed: Less than 50.
- B. All products shall be certified by Greenguard Environmental Institute; independent testing of products for emissions of respirable particles and Volatile Organic Compounds (VOC's), including formaldehyde and other specific product-related pollutants. Greenguard provides independent, third-party certification of IAQ performance. Certification is based upon criteria used by EPA, OSHA and WHO.
- C. Rated Positive Pressure: 10" w.g. per UL-181. Maximum negative pressure: ¾".
- D. Flexible Ducts, Insulated: Factory-fabricated, insulated, round duct, with an outer jacket enclosing glass-fiber insulation around a continuous inner liner.
  - 1. R6 insulation, Basis of Design: Atco #86
  - 2. Reinforcement: Steel-wire helix encapsulated in inner liner.
  - 3. Jacket (inner and outer): Polyethylene film.
- E. Flexible Duct Clamps: Stainless-steel band with cadmium-plated hex screw to tighten band with a worm-gear action, in sizes 3 to 18 inches to suit duct size.
- F. Hangers shall be band type, 1" wide minimum.

## PART 3 - EXECUTION

### 3.1 DUCT INSTALLATION, GENERAL

- A. Drawing plans, schematics, and diagrams indicate general location and arrangement of duct system. Indicated duct locations, configurations, and arrangements were used to size ducts and calculate friction loss for air-handling equipment sizing and for other design considerations. Provide duct systems as indicated unless deviations to layout are approved on Shop Drawings and Coordination Drawings.
- B. Provide ducts and accessories according to SMACNA's "HVAC Duct Construction Standards - Metal and Flexible" unless otherwise indicated.
- C. Construct and install each duct system for the specific duct pressure classification indicated.
- D. Properly seam, brace, stiffen, support and render ducts mechanically airtight. Adjust ducts to suit job conditions. Dimensions may be changed as approved, if cross sectional area is maintained.

- E. Provide ducts in lengths not less than 12 feet, unless interrupted by fittings. Provide ducts with fewest possible joints.
- F. Provide fabricated fittings for changes in directions, changes in size and shape, and connections.
- G. Provide couplings tight to duct wall surface with a minimum of projections into duct.
- H. Provide ductwork to allow maximum headroom. Provide ducts, unless otherwise indicated, vertically and horizontally, parallel and perpendicular to building lines; avoid diagonal runs. Provide ducts close to walls, overhead construction, columns, and other structural and permanent enclosure elements of building.
- I. Provide ducts with a clearance of 1 inch, plus allowance for insulation thickness.
- J. Conceal ducts from view in finished spaces. Do not encase horizontal runs in solid partitions, unless specifically indicated.
- K. Provide volume dampers at all branch ducts to RGD's. If volume dampers are inadvertently not shown, contractor shall provide, the intent is to provide volume dampers at all branches.
- L. Coordinate layout with suspended ceiling, lighting layouts, and similar finished work.
- M. Electrical Equipment Spaces: Route ductwork to avoid passing electrical equipment spaces and enclosures.
- N. Provide duct accessories of materials suited to duct materials; use galvanized-steel accessories in galvanized-steel ducts, stainless-steel accessories in stainless-steel ducts, and aluminum accessories in aluminum ducts.

### 3.2 MATERIALS

- A. Hangers, accessories, and dampers shall be same material as parent duct.
- B. Refer to Specification Section 230700 for sheet metal covering of rigid insulation for protection from maintenance personnel crossing insulated ductwork in mechanical spaces.
- C. All ducts shall be G60 galvanized steel.

### 3.3 DUCT CLASSIFICATIONS AND SEALING

- A. Static-Pressure Classifications: Unless otherwise indicated, construct ducts to the following:
  - 1. Supply duct upstream of VAV terminal units: 4 in. w.g.
  - 2. Supply Ducts downstream of VAV terminal units: 2-inch wg.
  - 3. Return Ducts: 2-inch wg, negative pressure.
  - 4. Exhaust Ducts: 2-inch wg, negative pressure.

## B. Seam And Joint Sealing

1. General: Seal duct seams and joints according to the duct pressure class indicated and as described in SMACNA's "HVAC Duct Construction Standards--Metal and Flexible."
2. Seal to SMACNA Class A; all joints, longitudinal and transverse seams, and connections in ductwork shall be securely fastened and sealed with welds, gaskets, or duct sealant. Exceptions:
  - a. Continuously welded and locking-type longitudinal joints and seams on ducts operating at less than 2 in. wg pressure classification.
  - b. Exposed exhaust or return ducts operating at less than 2 in. wg pressure classification.
  - c. Exposed supply ducts in the space that the duct serves.
3. Seal externally insulated ducts before insulation installation.

## 3.4 DUCT PENETRATIONS

- A. Fire or Smoke Rated Penetrations not requiring a fire and/or smoke damper: Where ducts pass through walls, floors, or partitions that are required to have a fire resistance rating and fire dampers are not required, the opening in the construction around the duct shall be as follows:
  1. Not exceeding a 1" average clearance on all sides.
  2. Filled solid with firestopping material as specified in Section 230500.
- B. Fire or Smoke Rated Penetrations: Provide fire and/or smoke damper as specified under Duct Accessories paragraph.
- C. Non-Fire-Rated Exposed Penetrations: Where ducts pass through interior partitions and exterior walls, and are exposed to view, conceal space between construction opening and duct or duct insulation with sheet metal flanges of same metal thickness as duct. Overlap opening on four sides by at least 1-1/2 inches.
- D. Non-Fire-Rated Concealed Penetrations: Provide insulation infill and acoustical sealant around gaps. Tightly seal to prevent sound transmission. Neatly finish.
- E. Flexible air ducts or connectors shall not pass through any wall, floor, or ceiling.

## 3.5 HANGER AND SUPPORT INSTALLATION

- A. Comply with SMACNA's "HVAC Duct Construction Standards - Metal and Flexible," Chapter 5, "Hangers and Supports."
- B. Building Attachments: Concrete inserts, powder-actuated fasteners, or structural-steel fasteners appropriate for construction materials to which hangers are being attached.
  1. Where practical, install concrete inserts before placing concrete.

2. Provide powder-actuated concrete fasteners after concrete is placed and completely cured.
  3. Use powder-actuated concrete fasteners for standard-weight aggregate concretes or for slabs more than 4 inches thick.
  4. Do not use powder-actuated concrete fasteners for lightweight-aggregate concretes or for slabs less than 4 inches thick.
  5. Do not use powder-actuated concrete fasteners for seismic restraints.
- C. Hanger Spacing: Comply with SMACNA's "HVAC Duct Construction Standards - Metal and Flexible," Table 5-1, "Rectangular Duct Hangers Minimum Size," and Table 5-2, "Minimum Hanger Sizes for Round Duct," for maximum hanger spacing; install hangers and supports within 24 inches of each elbow and within 48 inches of each branch intersection.
- D. Support vertical ducts with steel angles or channel secured to the sides of the duct with welds, bolts, sheet metal screws, or blind rivets; support at each floor and at a maximum intervals of 16 feet.
- E. Provide upper attachments to structures. Select and size upper attachments with pull-out, tension,

### 3.6 FLEXIBLE DUCT

- A. Provide in accordance with manufacturer's and Air Diffusion Council recommendations.
- B. Flexible ducts shall be supported at manufacturer's recommended intervals, but at no greater distance than 5 feet. Maximum permissible sag is 1/2" per foot of spacing between supports.
- C. Provide duct fully extended; do not install in the compressed state or use excess lengths.
- D. Avoid bending ducts across sharp corners or incidental contact with metal fixtures, pipes, conduits, or hot equipment. Radius at centerline shall not be less than one duct diameter.
- E. Hanger or saddle material in contact with the duct shall be at least 1-1/2" wide.
- F. Provide at least 2 duct diameters of straight duct at the entrance to register, grilles, and diffusers.

### 3.7 DUCT ACCESSORIES INSTALLATION

- A. Provide duct accessories according to applicable details shown in SMACNA's "HVAC Duct Construction Standards--Metal and Flexible".
- B. Provide duct transitions, offsets and connections to dampers, coils, and other equipment in accordance with SMACNA Standards
- C. Each register, grille, or diffuser shall have a means of air flow adjustment. Provide volume damper in branch duct if not furnished with the RGD.

- D. Adjust operable devices for proper action.
- E. Perform the following as directed by the controls contractor:
  - 1. Installation of control devices
  - 2. Access doors where indicated and as required.
- F. Provide duct access panels for access components that require servicing.
  - 1. Provide duct access panels to allow access to interior of ducts for cleaning, inspecting, adjusting, and maintaining per equipment manufacturers' requirements.
  - 2. Provide access panels on side of duct where adequate clearance is available.
  - 3. Locate panel upstream and/or downstream as recommended by manufacturer.
    - a. Adjacent to and close enough to life safety dampers, to reset or reinstall fusible links. Access doors for access to dampers having fusible links shall be pressure relief access doors and shall be outward operation for access doors installed upstream from dampers and inward operation for access doors installed downstream from dampers.
    - b. Control devices requiring inspection.
    - c. Elsewhere as indicated or required by duct accessory manufacturer
  - 4. Inspect locations of access doors and verify that purpose of access door can be performed.
- G. Fire Damper Installation
  - 1. Examine areas to receive dampers. Notify the Engineer of conditions that would adversely affect installation or subsequent utilization of dampers. Do not proceed with installation until unsatisfactory conditions are corrected
  - 2. Provide dampers in accordance with manufacturer's UL Installation Instructions, labeling, and NFPA 90A at locations indicated on the drawings. Any damper installation that is not in accordance with the manufacturer's UL Installation Instructions must be approved prior to installation.
  - 3. Dampers must be accessible to allow inspection, adjustment, and replacement of components. The sheet metal contractor shall furnish any access doors in ductwork or plenums required to provide this access. The general contractor shall furnish any access doors required in walls, ceilings, or other general building construction.
  - 4. Provide dampers square and free from racking.
  - 5. The installing contractor shall provide and install bracing for multiple section assemblies to support assembly weight and to hold against system pressure.
  - 6. Do not compress or stretch the damper frame into the duct or opening.
  - 7. Attach multiple damper section assemblies together in accordance with manufacturer's instructions. Provide support mullions as reinforcement between assemblies as required.
  - 8. Handle dampers using the frame or sleeve. Do not lift or move dampers using blades, actuator or jackshaft.
  - 9. Provide access door, properly located for servicing.
  - 10. Tests and Inspections: Operate dampers to verify full range of movement and verify that proper heat-response device is installed.

- H. Fire Damper Maintenance: Re-commission the existing fire dampers in accordance with manufacturer's recommendations. As a minimum, the following shall be performed.
1. If cleaning is necessary, use mild detergents or solvents.
  2. If frame is 'racked' causing blades to bind on jamb seals, adjust frame such that it is square and plumb
  3. Fusible links shall be removed.
  4. Operate to verify that they close fully.
  5. Latch shall be checked.
  6. Lubricate axle bearings, jackshaft bearings, jamb seals, and other moving parts. Do not use oil-based lubricants or any other lubricants that attract contaminants such as dust.
  7. Replace fusible link.

### 3.8 DUCT LINER INSTALLATIONS

- A. All portions of duct designated to receive duct liner shall be completely covered with duct liner. All joints shall be neatly butted and there shall be no interruptions or gaps. Duct liner shall be installed with the printed air stream surface treatment exposed to the air stream.
- B. Duct liner shall be adhered to the sheet metal with 90% (minimum) coverage of adhesive complying with the requirements of ASTM C 916.
- C. All transverse edges that are not to receive sheet metal nosing shall be coated. Longitudinal joints shall occur at the corners of ducts. If duct size and standard duct liner product dimensions make exposed longitudinal joints necessary, such joints shall be coated with adhesive designated for duct liner application and which meets the requirements of ASTM C 916. Such joints shall be additionally secured with mechanical fasteners in accordance with NAIMA FGDLs, or SMACNA HVAC DCS as if they were transverse joints.
- D. Duct liner shall be additionally secured with mechanical fasteners complying with the requirements NAIMA FGDLs or SMACNA HVAC DCS and of the correct type for the duct liner being installed. Fasteners may be either weld-secured or impact-driven, and shall be installed perpendicular to the duct surface. Mechanical fasteners shall not compress the insulation more than 1/8" based on nominal insulation thickness. Fastener spacing with respect to interior duct dimensions shall be in accordance with NAIMA FGDLs or SMACNA HVAC DCS. Fastener heads or washers shall have a minimum area of 0.75 in<sup>2</sup>, with beveled or cupped edges to prevent their cutting into the duct liner.
- E. Metal nosing shall be securely installed over transverse liner edges facing the airstream at fan discharge and at any point where lined duct is preceded by unlined duct.
- F. Any damage to the air stream surface must be repaired by coating the damaged area with adhesive or coating designed for duct liner application. Adhesive or coating shall meet requirements of ASTM C 916.

3.9 FIELD QUALITY CONTROL

- A. Protect duct interiors from moisture, construction debris and dust, and other foreign materials. Comply with SMACNA's "IAQ Guidelines for Occupied Buildings Under Construction," Appendix G, "Duct Cleanliness for New Construction Guidelines."
- B. HVAC systems shall not be operated during construction.
- C. Systems shall not be operated without filters in place.
- D. Upon completion of installation duct systems and before HVAC system start-up, visually inspect the ductwork proper installation
- E. Cover supply openings with filter media prior to system start-up to catch any loose material that may remain inside the ductwork. Turn the HVAC system on and allow it to run until steady state operation is reached. Remove the temporary filter media from supply openings and, along with it, any loose material blown downstream and caught by the filter media.
- F. All ductwork shall be provided with temporary enclosures to keep the HVAC system free of dust and construction debris. The HVAC system includes any interior surface of the facility's air distribution system for conditioned spaces and/or occupied zones. This includes the entire duct from the points where the air enters the system to the points where the air is discharged from the system.
- G. Check all filters in accordance with their manufacturer's instructions. Use specified grade of filters at all times that system is operating.

END OF SECTION 233113



## SECTION 233423 - POWER AND GRAVITY VENTILATORS

### PART 1 - GENERAL

#### 1.1 RELATED DOCUMENTS

- A. Drawings and general provisions of the Contract, including General and Supplementary Conditions and Division 1 Specification Sections, apply to this Section.
- B. Related Sections include the following:
  - 1. Division 23 Section "Common Work Results for Mechanical"

#### 1.2 SUMMARY

- A. This Section includes fans and ventilators.

#### 1.3 ACTION SUBMITTALS

- A. Product Data: Include rated capacities, furnished specialties, and accessories for each type of product indicated and include the following:
  - 1. Certified fan performance curves with system operating conditions indicated.
  - 2. Certified fan sound-power ratings.
  - 3. Motor ratings and electrical characteristics, plus motor and electrical accessories.
  - 4. Material gages and finishes, including color charts.
  - 5. Wiring Diagrams: Power, signal, and control wiring.
  - 6. Vibration Isolation

#### 1.4 CLOSEOUT SUBMITTALS

- A. Operation and Maintenance Data: For power ventilators to include in emergency, operation, and maintenance manuals.

#### 1.5 QUALITY ASSURANCE

- A. Electrical Components, Devices, and Accessories: Listed and labeled as defined in NFPA 70, Article 100, by a testing agency acceptable to authorities having jurisdiction, and marked for intended use.

- B. AMCA Compliance: Products shall comply with performance requirements and shall be licensed to use the AMCA-Certified Ratings Seal for sound and air performance.
  - 1. Sound-Power Level Ratings: Comply with AMCA 301, "Methods for Calculating Fan Sound Ratings from Laboratory Test Data." Factory test fans according to AMCA 300, "Reverberant Room Method for Sound Testing of Fans." Label fans with the AMCA-Certified Ratings Seal.
  - 2. Fan Performance Ratings: Establish flow rate, pressure, power, air density, speed of rotation, and efficiency by factory tests and ratings according to AMCA 210, "Laboratory Methods of Testing Fans for Rating."
- C. NEMA Compliance: Motors and electrical accessories shall comply with NEMA standards.
- D. UL Standards: Power ventilators shall comply with UL 705.

#### 1.6 DELIVERY, STORAGE, AND HANDLING

- A. Deliver fans as factory-assembled unit, to the extent allowable by shipping limitations, with protective crating and covering.
- B. Disassemble and reassemble units, as required for moving to final location, according to manufacturer's written instructions.
- C. Lift and support units with manufacturer's designated lifting or supporting points.

#### 1.7 COORDINATION

- A. Refer to Division 23 Section "Common Work Results for Mechanical"

### PART 2 - PRODUCTS

#### 2.1 MANUFACTURERS

- A. Manufacturers: Subject to compliance with requirements, provide products by one of the following:
  - 1. Greenheck
  - 2. Penn Ventilation Companies, Inc.
  - 3. Acme Engineering & Mfg. Corp.
  - 4. Cook
  - 5. Panasonic

#### 2.2 GENERAL FAN REQUIREMENTS

- A. Motors: Include built-in, thermal-overload protection and grease-lubricated ball bearings. Select each motor to be non-overloading over full range of pump performance curve. Comply with NEMA MG 1 requirements for thermally protected motors.
- B. Motors Indicated to be premium efficiency, and shall meet or exceed all NEMA Standards Publication MG1 requirements and comply with NEMA premium efficiency levels Class B temperature rise; Class F insulation.

### 2.3 CEILING-MOUNTING VENTILATORS

- A. Description: Centrifugal fans for installing in ceiling or for concealed in-line installation as scheduled.
- B. Housing: Steel, lined with acoustical insulation. To accommodate different ceiling thickness, an adjustable pre-punched mounting bracket shall be provided.
- C. Fan Wheel: Centrifugal wheels directly mounted on motor shaft. Fan shrouds, motor, and fan wheel shall be removable for service.
- D. The outlet duct collar shall include a reinforced aluminum damper with continuous aluminum hinge rod and brass bushings.
- E. Grille: white, calcium carbonate.
- F. Electrical Requirements: Junction box for electrical connection on housing and receptacle for motor plug-in. Motor shall have permanently lubricated bearings, built-in thermal overload protection and disconnect plug.
- G. Accessories:
  - 1. Variable-Speed Controller, wall-mount (unit mount for inline); solid-state control to reduce speed from 100 percent to less than 50 percent.
  - 2. Disconnect switch
  - 3. Isolation Kit: Rubber-in-shear hanging vibration isolators.
  - 4. Flexible duct connectors

## PART 3 - EXECUTION

### 3.1 INSTALLATION

- A. Provide power ventilators level and plumb.
- B. Provide vibration isolation as specified.
- C. Support suspended units from structure using threaded steel rods and spring hangers.

- D. Provide units with clearances for service and maintenance.
- E. Label units according to requirements specified in the Division 23 HVAC Identification Section.

### 3.2 CONNECTIONS

- A. Duct installation and connection requirements are specified in other Division 23 Sections. Drawings indicate general arrangement of ducts and duct accessories. Make final duct connections with flexible connectors. Flexible connectors are specified in Division 23 Section "Ductwork."
- B. Provide ducts adjacent to power ventilators to allow service and maintenance.

### 3.3 FIELD QUALITY CONTROL

- A. Equipment Startup Checks and Adjustments:
  - 1. Verify that shipping, blocking, and bracing are removed.
  - 2. Verify that unit is secure on mountings and supporting devices. Verify that connections to ducts and electrical components are complete. Verify that proper thermal-overload protection is installed in motors, starters, and disconnect switches.
  - 3. Verify that cleaning and adjusting are complete.
  - 4. Inspect and tighten fasteners and setscrews, particularly fan mounting and bearing fasteners.
  - 5. Disconnect fan drive from motor, verify proper motor rotation direction, and verify fan wheel free rotation and smooth bearing operation.
  - 6. Verify lubrication for bearings and other moving parts.
  - 7. Verify that dampers in connected ductwork systems are in fully open position.
  - 8. Lubricate bearings.
- B. Operational Test: After electrical circuitry has been energized, start units to confirm proper motor rotation and unit operation. Remove malfunctioning units, replace with new units, and retest.
- C. Refer to Division 23 Section "Testing, Adjusting, and Balancing" for testing, adjusting, and balancing procedures.

END OF SECTION 233423

## SECTION 233600 - AIR TERMINAL UNITS

### PART 1 - GENERAL

#### 1.1 RELATED DOCUMENTS

- A. Drawings and general provisions of the Contract, including General and Supplementary Conditions and Division 1 Specification Sections, apply to this Section.
- B. Related Sections include the following:
  - 1. Division 23 Section "Common Work Results for HVAC"
  - 2. Division 23 Controls Section for control devices installed on air terminals.

#### 1.2 SUMMARY

- A. This Section includes single-duct and fan-powered air terminals.

#### 1.3 ACTION SUBMITTALS

- A. Product Data: For each type of air terminal unit.
  - 1. Include construction details, material descriptions, dimensions of individual components and profiles, and finishes for air terminal units.
  - 2. Include rated capacities, operating characteristics, electrical characteristics, and furnished specialties and accessories.

#### 1.4 CLOSEOUT SUBMITTALS

- A. Operation and Maintenance Data: For air terminal units to include in emergency, operation, and maintenance manuals.

#### 1.5 QUALITY ASSURANCE

- A. Product Options: Drawings and schedules indicate requirements of air terminals and are based on specific systems indicated. Other manufacturers' systems with equal performance characteristics may be considered. Refer to Division 1 Section "Substitutions."
- B. Listing and Labeling: Provide electrically operated air terminals specified in this Section that are listed and labeled. The Terms "Listed" and "Labeled": As defined in NFPA 70, Article 100. Listing and Labeling Agency Qualifications: A "Nationally Recognized Testing Laboratory" as defined in OSHA Regulation 1910.7.

- C. Testing Requirements: Test and rate air terminals according to ARI 880, "Industry Standard for Air Terminals."
- D. Identification: Label each air terminal with plan number, nominal airflow, maximum and minimum factory-set airflows, coil type, and ARI certification seal.
- E. NFPA Compliance: Provide air terminals according to NFPA 90A, "Standard for the Installation of Air Conditioning and Ventilating Systems."
- F. Comply with NFPA 70 for electrical components and installation.
- G. ASHRAE Compliance: Applicable requirements in ASHRAE 62.1.

## PART 2 - PRODUCTS

### 2.1 MANUFACTURERS

- A. Manufacturers: Subject to compliance with requirements, provide air terminals by one of the following:
  - 1. Trane
  - 2. Titus
  - 3. Environmental Technologies.
  - 4. Price
  - 5. Metal Aire
  - 6. Krueger

### 2.2 AIR TERMINALS

- A. The unit casing shall be comprised of 22 gauge galvanized steel. Outlet connection shall be slip and drive.
- B. Terminal units shall be ARI 880 - 98 certified and UL Listed.
- C. Casings: 22 gauge galvanized steel. Maximum casing leakage: 7 cfm at 1-inch wg inlet static pressure.
- D. 3/8" Closed-cell Insulation—Interior surface of the unit casing is acoustically and thermally lined with 3/8-inch, 4.4 lb/ft<sup>3</sup> closed-cell insulation. Insulation is UL listed and meets NFPA-90A and UL 181 standards. Insulation has an R-Value of 1.4. There are no exposed edges of insulation (complete metal encapsulation).
- E. The air inlet connection shall be an 18 gauge galvanized steel cylinder sized to fit standard round duct. A multiple point, averaging flow sensing ring shall be provided with balancing taps for measuring within +/- 5% of unit cataloged airflow. Airflow versus pressure differential calibration chart shall be provided. The damper blade shall be constructed of a closed cell foam seal mechanically locked between two 22 gauge galvanized steel disks. The damper blade

assembly shall be connected to a cast zinc shaft supported by self lubricating bearings. The shaft shall be cast with a damper position indicator. The valve assembly shall include a mechanical stop to prevent over stroking. At 4.0" wg air valve leakage does not exceed 1% of cataloged airflow.

- F. Electric Heat Coil: Factory provided and mounted. Resistance open-type heater, a disc-type automatic thermal primary safety device and manual reset load thermal secondary device. Heater element material is nickel-chromium. The heater terminal box is provided with knockouts for customer power supply. Terminal connections are plated steel with ceramic or phenolic insulators.
1. SCR controlled.
  2. Downstream air temperature sensor with local connection to override discharge-air temperature to not exceed a maximum temperature set point (adjustable).
  3. Airflow switch for proof of airflow.
  4. Fan interlock contacts.
  5. Fuse: Any electric heat unit with a calculated MCA greater or equal to 30 will have a fan fuse provided.
  6. Fan-powered units with electric reheat are single-point power connections.
  7. Power Disconnect Switch: A factory provided interlocking door disconnect switch located on the electric heater control panel.
- G. A 50 VA transformer shall be factory mounted in an enclosure with 7/8" knockouts to provide 24 VAC for controls. Note: not needed if plans show junction boxes for power connections by BAS contractor.
- H. Disconnect Switch: A NEMA-1 toggle disconnect shall disengage primary power to terminal.
- I. Controls: The terminals will have pressure independent direct digital controls supplied and mounted by the control contractor. Terminals shall be furnished with a pneumatic inlet velocity sensor. The sensor shall be multi-point center averaging type, with a minimum of four measuring ports parallel to the take-off point from the sensor. Sensors with measuring ports in series are not acceptable. The sensor must provide a minimum differential pressure signal of 0.03" wg at an inlet velocity of 500 fpm. Flow measuring taps and flow curves shall be supplied with each terminal for field balancing airflow. All pneumatic tubing shall be UL listed fire retardant (FR) type.
- J. Fan Powered Air Terminals: The ECM motor shall be a single speed DC "brush less" motor with integrated controller. Motor and fan assembly are isolated from terminal unit.
- K. Each terminal shall be equipped with labeling showing unit location, size, and scheduled cfm.

## 2.3 CONTROL

- A. Provide in complete coordination with Section 230900.

### PART 3 - EXECUTION

#### 3.1 INSTALLATION

- A. Provide air terminals level and plumb, according to manufacturer's written instructions, rough-in drawings, original design, and referenced standards.
- B. Allow adequate clearance to meet NEC on control box side of unit to meet NEC.
- C. Support in accordance with SMACNA and manufacturer recommendations.
- D. Connect ductwork to air terminals according to Division 23 ductwork Sections. Slip each inlet duct over the inlet collar of the terminal. Fasten and seal the connection airtight. The diameter of the inlet duct must be equal to the listed size of the terminal.
- E. Inlet and outlet duct must be installed in accordance with SMACNA guidelines. Provide a minimum of 2.5 equivalent duct diameters of straight duct at the inlet.

#### 3.2 CONNECTIONS

- A. Provide piping adjacent to air terminals to allow service and maintenance.
- B. Electrical: Comply with applicable requirements in Division 26 Sections. Ground equipment. Tighten electrical connectors and terminals according to manufacturer's published torque-tightening values. Where manufacturer's torque values are not indicated, use those specified in UL 486A and UL 486B.

#### 3.3 FIELD QUALITY CONTROL

- A. Perform the following tests and inspections:
  - 1. After installing air terminal units and after electrical circuitry has been energized, test for compliance with requirements.
  - 2. Operational Test: After electrical circuitry has been energized, operate electric coils to confirm proper unit operation.
  - 3. Test and adjust controls and safeties. Replace damaged and malfunctioning controls and equipment.
- B. Air terminal unit will be considered defective if it does not pass tests and inspections.
- C. Prepare test and inspection reports.

#### 3.4 STARTUP SERVICE

- A. Perform startup service.
  - 1. Complete installation and startup checks according to manufacturer's written instructions.



2. Verify that inlet duct connections are as recommended by air terminal unit manufacturer to achieve proper performance.
3. Verify that controls and control enclosure are accessible.
4. Verify that control connections are complete.
5. Verify that nameplate and identification tag are visible.
6. Verify that controls respond to inputs as specified.

### 3.5 CLEANING

- A. After completing system installation, including outlet fittings and devices, inspect exposed finish. Remove burrs, dirt, and construction debris, and repair damaged finishes.

END OF SECTION 233600



## SECTION 233713 - DIFFUSERS, REGISTERS, AND GRILLES

### PART 1 - GENERAL

#### 1.1 RELATED DOCUMENTS

- A. Drawings and general provisions of the Contract, including General and Supplementary Conditions and Division 1 Specification Sections, apply to this Section.
- B. Related Sections include the following:
  - 1. Division 23 Section "Common Work Results for HVAC"
  - 2. Division 23 Section "Ductwork"
  - 3. Division 23 Section "Testing, Adjusting, and Balancing".

#### 1.2 SUMMARY

- A. This Section includes ceiling- and wall-mounted diffusers, registers, and grilles.

#### 1.3 DEFINITIONS

- A. Diffuser: Circular, square, or rectangular air distribution outlet, generally located in the ceiling and comprised of deflecting members discharging supply air in various directions and planes and arranged to promote mixing of primary air with secondary room air.
- B. Grille: A louvered or perforated covering for an opening in an air passage, which can be located in a sidewall, ceiling, or floor.
- C. Register: A combination grille and damper.

#### 1.4 SUBMITTALS

- A. Each manufacturer shall check noise level ratings for registers and diffusers to insure that the sizes selected will not produce noise to exceed 30 db, "A" scale, measured at occupant level; notify Owner's representative of problems prior to shop drawing submittal.
- B. Pressure drop, airflow and noise criteria selection is based on design equipment. Manufacturers not submitting design makes must provide written certification in front of submittal that equipment submitted has been checked against and performs equal to the design make.
- C. Product Data: For each model indicated, include the following:
  - 1. Data Sheet: For each type of air outlet and inlet, and accessory furnished; indicate construction, finish, and mounting details.

2. Performance Data: Include throw and drop, static-pressure drop, and noise ratings for each type of air outlet and inlet.
  3. Schedule of diffusers, registers, and grilles indicating drawing designation, room location, quantity, model number, size, and accessories furnished.
  4. Assembly Drawing: For each type of air outlet and inlet; indicate materials and methods of assembly of components.
- D. Coordinate locations with reflected ceiling plans and wall elevations as applicable.
- E. Coordinate mounting frame with associated mounting surface.

## 1.5 QUALITY ASSURANCE

- A. Product Options: Drawings and schedules indicate specific requirements of diffusers, registers, and grilles and are based on the specific requirements of the systems indicated. Other manufacturers' products with equal performance characteristics may be considered. Refer to Division 1 Section "Substitutions."
- B. NFPA Compliance: Install diffusers, registers, and grilles according to NFPA 90A.
- C. Sound pressure levels shall be determined by using AHRI Standard 885-2008 "Procedure for Estimating Occupied Space Sound Levels in the Application of Air Terminals and Outlets".

## PART 2 - PRODUCTS

### 2.1 GENERAL

- A. Diffusers, registers, and grilles are scheduled on Drawings. Mounting type shall match the mounting surface. Coordinate with mounting conditions.
- B. Material shall match the specified ductwork. Coordinate with Section 233113 "Ductwork".
- C. Testing: Test performance according to ASHRAE 70, "Method of Testing for Rating the Performance of Air Outlets and Inlets."
- D. Grilles shall be finished in White Powder Coat, unless noted otherwise.
- E. Manufacturers
1. Price
  2. Titus
  3. Metal-Aire
  4. Anemostat
  5. Nailor

## 2.2 RETURN OR EXHAUST

### A. Return/Exhaust Grille, 45-degree deflection

1. Material: steel (Price 530 Series) or aluminum (Price 630 Series)
2. Provide damper as scheduled.
3. Grilles of the sizes indicated on the plans. Grilles shall be 45 degree deflection fixed louver type with blades spaced 3/4" on center. The blades shall run parallel to the long dimension of the grille.

## 2.3 SUPPLY

### A. Double-deflection Supply Register

1. Material: steel (Price 520D Series) or aluminum (Price 620D Series)
2. Grilles of the sizes indicated on the plans.
3. Registers shall be double deflection type with two sets of fully adjustable deflection blades spaced 3/4" on center. The front set of blades shall run parallel to the short dimension of the register.
4. The integral volume control damper shall be of the opposed blade type. Material shall match the register material. The damper shall be operable from the register face.

### B. Square flat face (Plaque) Diffusers

1. Price model (SPD steel, SPD AS aluminized steel, ASPD aluminum) ceiling diffusers of sizes and mounting types designated by the plans and air distribution schedule.
2. Diffusers shall consist of a precision formed back cone of one piece seamless construction which incorporates a round inlet collar of sufficient length for connecting rigid or flexible duct. An inner plaque assembly shall be incorporated that drops no more than 1/4" below the ceiling plane to assure proper air distribution performance.
3. The inner plaque assembly shall be completely removable from the diffuser face to allow full access to any dampers or other ductwork components located near the diffuser neck.
4. Provide combination damper and equalizing grid for the round duct take-off. Fully adjustable damper blade opens directly into air stream for precision air control. Louver blades shall be individually adjustable and spring-tensioned to maintain setting. Easily operated from the face of the diffuser with slotted operator. Constructed of heavy cold rolled steel frame and extruded aluminum blades. Finish: Black.

### C. Linear Vane Diffusers

1. Furnish and install Price model LV1 linear vane supply diffusers of the sizes, configurations and mounting types indicated on the plans and outlet schedule. Diffusers shall have fixed extruded aluminum 1-way deflection louvers with a minimum vane depth of 1-3/8". The core assembly shall be of Mandrel tube construction and shall be removable from the outer border for installation. The diffuser border shall be heavy extruded aluminum construction. Continuous length units shall be provided with factory assembled corner modules to suit drawings and site conditions. Alignment pins shall be provided to align continuous length assemblies.

2. The diffuser shall be provided with rear mounted, individually-adjustable extruded aluminum blades spaced 1 in. on center for directional and spread control.
3. The diffuser shall be provided with insulated plenums. Plenums shall be constructed of zinc coated steel and have 1/4" internal insulation. Plenum assemblies shall be of a side inlet configuration.

## PART 3 - EXECUTION

### 3.1 EXAMINATION

- A. Examine areas where diffusers, registers, and grilles are to be installed for compliance with requirements for installation tolerances and other conditions affecting performance of equipment. Do not proceed with installation until unsatisfactory conditions have been corrected.

### 3.2 INSTALLATION

- A. Install diffusers, registers, and grilles level and plumb, according to manufacturer's written instructions, Coordination Drawings, original design, and referenced standards.
- B. Drawings indicate general arrangement of ducts, fittings, and accessories. Air outlet and inlet locations have been indicated to achieve design requirements for air volume, noise criteria, airflow pattern, throw, and pressure drop. Make final locations where indicated, as much as practicable. For units installed in lay-in ceiling panels, locate units in the center of the panel. Where architectural features or other items conflict with installation, notify Architect for a determination of final location.
- C. Provide diffusers, registers, and grilles with airtight connection to ducts.
- D. Provide 2 feet minimum of straight ductwork at the entrance to diffusers.
- E. Plenum boxes on grilles/registers shall be 8" minimum height.

### 3.3 ADJUSTING & CLEANING

- A. After installation, adjust diffusers, registers, and grilles to air patterns indicated, or as directed, before starting air balancing.
- B. Adjustable outlet diffuser: adjust pattern for draft-free air distribution.
- C. After installation of diffusers, registers, and grilles, inspect exposed finish. Clean exposed surfaces to remove burrs, dirt, and smudges. Replace diffusers, registers, and grilles that have damaged finishes.

END OF SECTION 233713

## SECTION 238130 – DUCTLESS SPLIT-SYSTEM AIR-CONDITIONING UNITS

### PART 1 - GENERAL

#### 1.1 RELATED DOCUMENTS

- A. Drawings and general provisions of the Contract, including General and Supplementary Conditions and Division 1 Specification Sections, apply to this Section.
- B. Division 23 Section “Common Work Results for HVAC”

#### 1.2 SUMMARY

- A. This Section includes split-system cooling only air-conditioning units consisting of separate evaporator-fan and compressor-condenser components. Units are designed for exposed or concealed mounting, and may be connected to ducts.

#### 1.3 SUBMITTALS

- A. Product Data: Include rated capacities, furnished specialties, and accessories for each type of product indicated. Include performance data in terms of capacities, outlet velocities, static pressures, sound power characteristics, motor requirements, and electrical characteristics.
- B. Operation and Maintenance Data: For split-system air-conditioning units to include in emergency, operation, and maintenance manuals.
- C. Warranty: Special warranty specified in this Section.

#### 1.4 QUALITY ASSURANCE

- A. Product Options: Drawings indicate size, profiles, and dimensional requirements of split-system units and are based on the specific system indicated. Refer to Division 1 Section "Product Requirements."
- B. Electrical Components, Devices, and Accessories: Listed and labeled as defined in NFPA 70, Article 100, by a testing agency acceptable to authorities having jurisdiction, and marked for intended use.
- C. Energy-Efficiency Ratio: Equal to or greater than prescribed by ASHRAE 90.1, "Energy Efficient Design of New Buildings except Low-Rise Residential Buildings."
- D. Coefficient of Performance: Equal to or greater than prescribed by ASHRAE 90.1, "Energy Efficient Design of New Buildings except Low-Rise Residential Buildings."

- E. A dry air holding charge shall be provided in the indoor section.
- F. The outdoor unit shall be pre-charged with R-410a refrigerant for 70 feet of refrigerant tubing.

#### 1.5 COORDINATION

- A. Provide equipment supports and roof penetrations in accordance with Division 7.

#### 1.6 WARRANTY

- A. The units shall have a manufacturer's parts and defects warranty for a period five (5) years from date of installation. The compressor shall have an extended warranty of seven (7) years from date of installation. If, during this period, any part should fail to function properly due to defects in workmanship or material, it shall be replaced or repaired at the discretion of the manufacturer. This warranty will not include labor.

### PART 2 - PRODUCTS

#### 2.1 MANUFACTURERS

- A. Manufacturers: Subject to compliance with requirements, provide products by one of the following:
  - 1. Mitsubishi
  - 2. Samsung
  - 3. Fujitsu
  - 4. Trane
  - 5. Daikin

#### 2.2 DUCTLESS SPLITS

- A. Indoor Unit, Mitsubishi Model PKA:
  - 1. The indoor unit cabinet shall be wall mounted by means of a factory supplied mounting plate. The cabinet shall be formed from high strength molded plastic with front panel access for filter. Cabinet color shall be white. The indoor unit shall be factory assembled, wired and tested. Contained within the unit shall be all factory wiring and internal piping, control circuit board and fan motor.
  - 2. The unit in conjunction with the wired, wall mounted controller shall have a self-diagnostic function, 3-minute time delay mechanism, an auto restart function, and a test run switch. Indoor unit and refrigerant pipes shall be purged with dry nitrogen before shipment from the factory.
  - 3. The evaporator fan shall be high performance, double inlet, forward curve, direct drive sirocco fan. The fans shall be statically and dynamically balanced and run on a motor with permanently lubricated bearings. There shall be a motorized horizontal vane to



automatically direct air flow in a horizontal and downward direction for uniform air distribution. The horizontal vane shall significantly decrease downward air resistance for lower noise levels, and shall close the outlet port when operation is stopped. There shall also be a set of vertical vanes to provide horizontal swing airflow movement selected by remote control.

4. Return air shall be filtered by means of an easily removable washable filter.
5. The evaporator coil shall be of nonferrous construction with pre-coated aluminum strake fins on copper tubing. The multi-angled heat exchanger shall have a modified fin shape that reduces air resistance for a smoother, quieter airflow. All tube joints shall be brazed with PhosCopper or silver alloy. The coils shall be pressure tested at the factory. A condensate pan and drain shall be provided under the coil.
6. The electrical power of the unit shall be 208 volts or 230 volts, 1 phase, 60 hertz as scheduled. The system shall be capable of satisfactory operation within voltage limits of 198 volts to 253 volts. The power to the indoor unit shall have an option of being supplied from the outdoor unit, using Mitsubishi Electric A-Control system or separate power source for indoor and outdoor units.
7. The control system shall consist of two (2) microprocessors, one on each indoor and outdoor unit, interconnected by a single non-polar two-wire cable. Field wiring shall run directly from the indoor unit to the wall mounted controller with no splices. For A-Control, a three (3) conductor 14 ga. AWG wire with ground shall provide power feed and bi-directional control transmission between the outdoor and indoor units. Where separate power is supplied to the indoor and outdoor units, a two (2) 20 ga. AWG wire shall be run between the units to provide forbid-directional control communication..
8. The system shall be capable of automatic restart when power is restored after power interruption. The system shall have self-diagnostics ability, including total hours of compressor run time. Diagnostics codes for indoor and outdoor units shall be displayed on the wired controller panel.
9. The microprocessor located in the indoor unit shall have the capability of monitoring return air temperature and indoor coil temperature, receiving and processing commands from the wired controller, providing emergency operation and controlling the outdoor unit.
10. The indoor unit shall be connected to a wall mounted wired controller to perform input functions necessary to operate the system. The wired controller shall have a large multi-language DOT liquid crystal display (LCD). There shall be a built-in weekly timer with up to eight pattern settings per day. The controller shall consist of an On/Off button, Increase/Decrease Set Temperature buttons, a Cool/Dry/Fan mode selector, a Timer Menu button, a Timer On/Off button, Set Time buttons, a Fan Speed selector, a Vane Position selector, a Louver Swing button, a Ventilation button, a Test Run button, and a Check Mode button. The controller shall have a built-in temperature sensor. Temperature changes shall be by increments of 1°F with a range of 67°F to 87°F.
11. The wired controller shall display operating conditions such as set temperature, room temperature, pipe temperatures (i.e. liquid, discharge, indoor and outdoor), compressor operating conditions (including running current, frequency, input voltage, On/Off status and operating time), LEV opening pulses, sub cooling and discharge super heat.
12. Normal operation of the wired controller shall provide individual system control in which one wired controller and one indoor unit are installed in the same room. The controller shall have the capability of controlling up to a maximum of sixteen systems at a maximum developed control cable distance of 1,500 feet.

13. The control voltage from the wired controller to the indoor unit shall be 12 volts, DC. The control signal between the indoor and outdoor unit shall be pulse signal 24 volts DC. Up to two wired controllers shall be able to be used to control one unit.
14. Control system shall control the continued operation of the air sweep louvers, as well as provide On/Off and mode switching. The controller shall have the capability to provide sequential starting with up to fifty seconds delay.

B. Outdoor Unit

1. The outdoor unit shall be compatible with the three different types of indoor units (PKA - wall mounted, PCA - ceiling suspending, and PLA - four way ceiling cassette). The connected indoor unit must be of the same capacity as the outdoor unit. The outdoor unit shall be equipped with a control board that interfaces with the indoor unit to perform all necessary operation functions.
2. The outdoor unit shall be capable of operating at 0°F ambient temperature without additional low ambient controls.
  - a. Provide optional wind baffle.
3. The outdoor unit shall be able to operate with a maximum height difference of 100 feet indoor unit to outdoor unit,
4. System shall have a maximum refrigerant tubing length of 100 feet for the 12,000 and 18,000 and 165 feet for the 24,000, 30,000 and 36,000 between indoor and outdoor units without the need for line size changes, traps or additional oil.
5. Unit shall be pre-charged for a maximum of 70 feet of refrigerant tubing. The outdoor unit shall be completely factory assembled, piped, and wired. Each unit must be test run at the factory.
6. The casing shall be constructed from galvanized steel plate, coated with a finished with an electrostatically applied, thermally fused acrylic or polyester powder coating for corrosion protection. The fan grille shall be of ABS plastic.
7. The fan motor shall be of aerodynamic design for quiet operation, and the fan motor bearings shall be permanently lubricated. The outdoor unit shall have horizontal discharge airflow. The fan shall be mounted in front of the coil, pulling air across it from the rear and dispelling it through the front. The fan shall be provided with a raised guard to prevent contact with moving parts.
8. The L shaped condenser coil shall be of copper tubing with flat aluminum fins to reduce debris build up. The coil shall be protected with an integral metal guard. Refrigerant flow from the condenser shall be controlled by means of linear expansion valve (LEV) metering orifice. The LEV shall be control by a microprocessor controlled step motor.
9. There shall be a DC rotary compressor with Variable Compressor Speed Inverter Technology. The compressor shall be driven by inverter circuit to control compressor speed. The compressor speed shall dynamically vary to match the room load for significantly increasing the efficiency of the system which results in vast energy savings. To prevent liquid from accumulating in the compressor during the off cycle, a minimal amount of current shall be intermittently applied to the compressor motor to maintain enough heat. The outdoor unit shall have an accumulator and high pressure safety switch. The compressor shall be mounted to avoid the transmission of vibration.
10. The electrical power of the unit shall be 208volts or 230 volts, 1 phase, 60 hertz. The unit shall be capable of satisfactory operation within voltage limits of 198 volts to 253 volts. The outdoor unit shall be controlled by the microprocessor located in the indoor unit.

11. The control signal between the indoor unit and the outdoor unit shall be pulse signal 24 volts DC. The unit shall have Pulse Amplitude Modulation circuit to utilize 98% of input power supply.

### 2.3 OUTDOOR UNIT SUPPORT STANDS

- A. Provide for systems that provide year round operation.
- B. Quick-Sling Model QSMS, or approved equal.
  1. 14 gauge square steel tubing powder coated for outdoor use.
  2. 24" height; sized to match the condensing unit, adjustable.
  3. Each foot shall be 6"x6" 11 gauge steel, adjustable up to 1.25" in height. Provide four (4) 3/8" holes, bolt the unit to the subsurface support. Securely fasten to roof sleepers with corrosion resistant fasteners.
  4. Adjustable in height up to 1.25"
  5. 50 durometer pads on each foot
  6. Max capacity 400 lbs.
  7. 4 points of anti-vibration isolation washers
  8. 2 additional support arms included
  9. Provide all required hardware.

### 2.4 LINE SETS

- A. PDM Preinsulated Pipes; "Gelcopper", Mitsubishi Diamondback Linesets; or approved equal.
- B. Polyethylene closed cell foam: assures thermal insulation from surroundings.
  1. ASTM C 1427-07 compliant
  2. Type I (tubular)
  3. Grade I (insulation material for use on typical commercial system non-crosslinked).
  4. Low-density polyethylene foam: closed cells foam, CFC and HCFC gas free
  5. Water vapor permeability: ASTM E96-00 compliant
  6. Working temperature: ASTM C 1427-07 compliant
  7. Wall thickness: 1/2" and 3/4"
  8. Surface burning characteristics: UL 94, top rated – UL 723,
  9. ASTM E84 (25/50) compliant, flame and Spread Index less than 25 and Smoke Development Index less than 50 as tested according to UL 723.
  10. R-Value: between 6.0 and 3.0 (depending on pipe diameter)
- C. Copper: Manufactured according to ASTM B280; No. C122200 DHP (phosphorous deoxidized, high residual phosphorous), 99.90%. R410a approved.
- D. Outer Jacket: Additional white polyethylene jacket cover protects foam insulation from tearing during installation process. Marking: insulation incrementally marked by every foot to ensure accurate initial unit charge. UV resistant. Paintable: The insulation can be painted to match the surroundings.

- E. Line Set Covers: Mitsubishi, Rectorseal, or approved equal. Precision engineered system of prefabricated PVC duct and fittings which conceals and protects exposed refrigeration line sets, wiring, and drain pipes. Made from extruded PVC duct with a full range of injection molded Polypropylene fittings, all of which meet the requirements of the current UL -94V-0 specification. Color: white. Provide stainless steel screws, retainer clips, wall covers, sleeves, fittings, and hardware for a neat, finished installation.

## PART 3 - EXECUTION

### 3.1 INSTALLATION

- A. Install units level and plumb.
- B. Install evaporator-fan components using manufacturer's standard mounting devices securely fastened to building structure.
- C. Provide roof-mounting condensing unit support components on equipment supports in accordance with Division 7. Provide quick-sling support stands.
- D. Anchor units to supports with removable, cadmium-plated fasteners.
- E. Install and connect pre-charged refrigerant tubing to component's quick-connect fittings. Install tubing to allow access to unit.

### 3.2 CONNECTIONS

- A. Piping installation requirements are specified in other Division 23 Sections. Drawings indicate general arrangement of piping, fittings, and specialties.
- B. Install piping adjacent to unit to allow service and maintenance.
- C. Coordinate locations of indoor units with structure, ceiling grid, and other trades – must maintain heat pump manufacturer's recommended service clearances.
- D. Provide insulated refrigerant piping per heat pump manufacturer's recommendations. Provide and connect pre-charged refrigerant tubing to component's quick-connect fittings. Provide tubing to allow access to unit. Test and inspect refrigerant piping according to ASME B31.5, Chapter VI.
- E. Exterior piping and wiring shall be enclosed in line set covers.
- F. Route indoor unit condensate drains to sink traps, floor drains, plumbing code compliant, or other locations as indicated.
- G. Electrical Connections: Comply with requirements in Electrical Specification Sections for power wiring, switches, and motor controls.

### 3.3 FIELD QUALITY CONTROL

- A. Manufacturer's Field Service: Engage a factory-authorized service representative to inspect, test, and adjust field-assembled components and equipment installation, including connections. Report results in writing.
- B. Perform the following field tests and inspections and prepare test reports:
  - 1. Leak Test: After installation, charge system and test for leaks. Repair leaks and retest until no leaks exist.
  - 2. Operational Test: After electrical circuitry has been energized, start units to confirm proper motor rotation and unit operation.
  - 3. Test and adjust controls and safeties. Replace damaged and malfunctioning controls and equipment.
- C. Remove and replace malfunctioning units and retest as specified above.

### 3.4 STARTUP SERVICE

- A. Engage a factory-authorized service representative to perform startup service. Complete installation and startup checks according to manufacturer's written instructions.

### 3.5 DEMONSTRATION

- A. Engage a factory-authorized service representative to train Owner's maintenance personnel to adjust, operate, and maintain units.
- B. Refer to Division 1 for further requirements.

END OF SECTION 238130



## SECTION 261000 - BASIC ELECTRICAL REQUIREMENTS

### PART 1 - GENERAL

#### 1.1 RELATED DOCUMENTS

- A. Drawings and general provisions of the Contract, including General and Supplementary Conditions and Division 01 Specification Sections, apply to this Section.

#### 1.2 SUMMARY

- A. Alternates: Refer to Division 01 to determine extent of, if any, work of this section that will be affected by any alternates if accepted.
- B. Furnish all materials, equipment, labor, and supplies and perform all operations necessary to complete the electrical work in accordance with the intent of the drawings and these specifications.
- C. Temporary Power and Lighting:
  - 1. Power Distribution: Provide weatherproof, grounded circuits with ground-fault interruption features, with proper power characteristics and either permanently wired or plug-in connections as appropriate for intended use. Provide overload-protected disconnect switch for each circuit at distribution panel. Space 4-gang convenience outlets (20 amp circuit) so that every portion of work can be reached with 100' extension cord.
  - 2. Temporary Lighting: Provide lighting of intensity and quality sufficient for proper and safe performance of the work and for access thereto and security thereof. (Consult OSHA requirements.)

#### 1.3 QUALITY ASSURANCE

- A. All wiring shall be in accordance with the latest issue of the National Electrical Code.
- B. The Contractor shall show evidence, upon request, of having successfully completed at least five similar projects. Installation of each system shall be under the supervision of a factory-authorized organization.
- C. The Contractor shall show evidence, upon request, that he maintains a fully equipped service organization capable of furnishing adequate inspection and service to the system. The Contractor must have a service contract program for the maintenance of the system after the guarantee period.
- D. All electrical equipment shall be listed by Underwriters Laboratories, Inc. Each system shall be products of a single manufacturer of established reputation and experience. The Contractor

shall have supplied similar apparatus to comparable installations rendering satisfactory service for at least three years.

- E. For each system, the manufacturer shall furnish "gratis" to the Owner a one-year contract effective from the date of installation for maintenance and inspection services of the manufacturer's equipment with a minimum of two inspections during the contract year.
- F. Prior to submission for review of any item of equipment, determine whether or not it will fit in the space provided. Any changes in the size or location of the material or equipment supplied, which may be necessary in order to meet field conditions or in order to avoid conflicts between trades, shall be brought to the immediate attention of the Architect/Engineer and approval received before such alterations are made.

#### 1.4 EFFICIENCY MAINE

- A. This project intends to pursue Efficient Maine prescriptive and/or custom incentives. The contractor shall be an Efficiency Maine Qualified Partner and shall participate in the activities associated with Efficiency Maine incentive pre-approval and approval process including but not limited to; preparation and submission of required incentive application(s) and the tracking and submission of measure specific invoices to Efficiency Maine within 60 days of the completion of the work.
- B. The contractor shall also:
  - 1. Become familiar with the Efficiency Maine Business Program including available incentives and the application and review process.
  - 2. Review plans and specifications for compliance with Efficiency Maine standards for applicable systems and technologies.
  - 3. Review plans and specifications for any and all incentive opportunities, prescriptive and custom.
- C. The project schedule shall reflect and accommodate the time required to achieve application preapproval from EM. No equipment shall be purchased until preapproval is received from EM.
- D. All invoices shall be forwarded to EM within 60 days of the completion of work. This deliverable shall be shown on the project schedule as a milestone date and coordinated with all contractors to assure compliance with this requirement.
- E. Efficiency Maine is available to assist in the application process and can be reached at 866-376-2463.

#### 1.5 FIRE ALARM SYSTEM

- A. Modify and add to the existing fire alarm system to provide a complete and code compliant system including but not limited to: new smoke detectors, heat detectors and notification appliances in all areas required. Fire alarm systems shall generally comply with requirements of NFPA 72 except as supplemented by this specification. All units of equipment shall be listed



by Underwriters Laboratories and shall consist of a battery-backed fire alarm control station, with audio/visual and visual alarm indicating devices, heat detectors, smoke detectors, and pull stations. All equipment shall be located as shown on the plans and wired in accordance with the manufacturer's instructions to form a complete and workable emergency evacuation life safety system as hereinafter described.

## 1.6 SUBMITTALS

### A. In accordance with Division 01, furnish the following:

1. Manufacturer's descriptive literature: For each type of product indicated.
2. Submit shop drawings which include engineering drawings of the system with specification sheets covering all component parts of the system and interconnection diagrams.
3. Submit fire alarm battery calculations.
4. Certification:
  - a. Prior to final inspection, deliver to the Owner's Representative certification that the material is in accordance with the drawings and specifications and has been properly installed.
  - b. Submit certification of system operating test.
5. Manuals: Submit copies of complete set of operating instructions including circuit diagrams and other information of system components.

## 1.7 PROJECT CONDITIONS

### A. Regulatory Requirements:

1. Conform to the requirements of all laws and regulations applicable to the work.
2. Cooperate with all authorities having jurisdiction.
3. Compliance with laws and regulations governing the work on this project does not relieve the Contractor from compliance with more restrictive requirements contained in these specifications.
4. If the Contract Documents are found to be at variance with any law or regulation, the Contractor shall notify the Architect/Engineer promptly in writing. The Contractor shall assume full responsibility for any work contrary to law or regulation, and shall bear all costs for the corrections thereof.
5. Minimum Requirements: The National Electrical Code (NEC), Underwriters Laboratories, Inc. (UL), the National Fire Codes, and National Fire Protection Association (NFPA) are a minimum requirement for work under this section. Design drawings and other specification sections shall govern in those instances where requirements are greater than those required by code.

### B. Permits, Fees, and Inspections:

1. Secure and pay for all permits, fees, licenses, inspections, etc., required for the work under Division 26.

2. Schedule and pay for all legally required inspections and cooperate with inspecting officers.
3. Provide Certificates of Inspection and Approval from all regulatory authorities having jurisdiction over the work in Division 26.

C. Drawings:

1. Do not scale the drawings. The general location of the apparatus and the details of the work are shown on the drawings, which form a part of this specification. Exact locations are to be determined at the building as the work progresses, and shall be subject to the Architect/Engineer's approval. Actual field conditions shall govern all dimensions.
2. Anything shown on the drawings and not mentioned in the specifications or vice versa shall be provided as if it were both shown and specified.
3. It is not intended that the drawings shall show every wire, device, fitting, conduit or appliance, but it shall be a requirement to furnish without additional expense, all material and labor necessary to complete the systems in accordance with applicable codes and the best practice of the trade.

1.8 WARRANTY

- A. The Contractor shall guarantee all equipment and wiring free from inherent mechanical or electrical defects for one year from date of acceptance.

1.9 RELATED WORK

- A. Division 23 - Mechanical

PART 2 - PRODUCTS

2.1 MATERIALS

A. Switches

1. Toggle Switches: 20A, 277V, 1-pole, ivory specification grade, mount 4'-0" above finished floor at door entrance.
2. Push-Button Switches: Modular, momentary-contact, low-voltage type connected to lighting control panels. Use for all permanently installed luminaires unless otherwise noted. Mount 4'-0" above finished floor at door entrance.

- B. Switchbox type occupancy sensors: Adaptive-technology type, 120/277 V, adjustable time delay up to 20 minutes, 180-degree field of view, with a minimum coverage area of 900 sq. ft. Configure for manual-on/automatic-off operation.

## C. Dimmers

1. Compatible and listed for use with light source to be dimmed.
2. Control: Continuously adjustable slider; with single-pole or three-way switching. Comply with UL 1472.

## D. Indoor Occupancy Sensors

1. General Description: Wall- or ceiling-mounting, solid-state units with a separate relay unit.
  - a. Operation: Unless otherwise indicated, turn lights on when covered area is occupied and off when unoccupied; with a time delay for turning lights off, adjustable over a minimum range of 1 to 15 minutes.
  - b. Sensor Output: Contacts rated to operate the connected relay, complying with UL 773A. Sensor shall be powered from the relay unit.
  - c. Relay Unit: Dry contacts rated for 20-A ballast load at 120- and 277-V ac, for 13-A tungsten at 120-V ac, and for 1 hp at 120-V ac. Power supply to sensor shall be 24-V dc, 150-mA, Class 2 power source as defined by NFPA 70.
  - d. Mounting:
    - 1) Sensor: Suitable for mounting in any position on a standard outlet box.
    - 2) Relay: Externally mounted through a 1/2-inch (13-mm) knockout in a standard electrical enclosure.
    - 3) Time-Delay and Sensitivity Adjustments: Recessed and concealed behind hinged door.
  - e. Indicator: LED, to show when motion is being detected during testing and normal operation of the sensor.
  - f. Bypass Switch: Override the on function in case of sensor failure.
  - g. Automatic Light-Level Sensor: Adjustable from 2 to 200 fc (21.5 to 2152 lx); keep lighting off when selected lighting level is present.
2. Dual-Technology Type: Ceiling mounting; detect occupancy by using a combination of PIR and ultrasonic detection methods in area of coverage. Particular technology or combination of technologies that controls on-off functions shall be selectable in the field by operating controls on unit.
  - a. Sensitivity Adjustment: Separate for each sensing technology.
  - b. Detector Sensitivity: Detect occurrences of 6-inch- (150-mm-) minimum movement of any portion of a human body that presents a target of not less than 36 sq. in. (232 sq. cm), and detect a person of average size and weight moving not less than 12 inches (305 mm) in either a horizontal or a vertical manner at an approximate speed of 12 inches/s (305 mm/s).
  - c. Detection Coverage (Standard Room): Detect occupancy anywhere within a circular area of 1000 sq. ft. (93 sq. m) when mounted on a 96-inch- (2440-mm-) high ceiling.

- E. Receptacles shall be specification grade, mounted 18" above finished floor unless otherwise noted.

- F. Duplex Receptacles With Ground-Fault Interrupter shall be an integral unit suitable for mounting in a standard outlet box.
1. Ground-Fault Interrupter shall consist of a differential current transformer, solid state sensing circuitry and a circuit interrupter switch. It shall be rated for operation on a 60 Hz, 120-volt, 20-ampere branch circuit. Device shall have nominal sensitivity to ground leakage current of five milliamperes and shall function to interrupt the current supply for any value of ground leakage current above five milliamperes on the load side of the device. Device shall have a minimum nominal tripping time of 1/30th of a second.
  2. Receptacle shall be rated 20 amperes, 125 volts for indoor use and shall be the standard duplex, three-wire, grounding type.
- G. Weatherproof Receptacles shall consist of a duplex GFI receptacle, as specified, mounted in a weatherproof box with a gasketed, weatherproof, cast metal cover plate. The weatherproof integrity shall not be affected when heavy duty specification or hospital grade attachment plug caps are inserted. Cover plates on outlet boxes mounted flush in the wall shall be gasketed to the wall in a watertight manner.
- H. Plates shall be high-abuse nylon or thermoplastic.
- I. Boxes shall be steel minimum 2-1/2" deep.
- J. Light Fixtures: The light fixtures shall be as described on the drawings or approved equal.
- K. Disconnect Switches shall be heavy-duty type, horsepower rated.
- L. Motor Starters:
1. Manual motor starters shall be toggle-switch type with melting alloy thermal overload relay. Thermal units shall be one-piece construction and interchangeable. Starter shall be inoperative with thermal unit removed. Contacts shall be double break, silver alloy. Starters in finished areas shall be flush mounted over the light switch at 60" above finished floor. Starters shall be mounted behind stainless steel device plate and shall have adjacent pilot lights. Square D Class 2510 Type FS-1P-FL1 or approved equal. Starters in unfinished areas shall be surface mounted 60" above finished floor. Square D Class 2510 Type FG-5P or approved equal.
  2. Magnetic motor starters shall be combination circuit breaker or fused disconnect switch type, mounted in a common enclosure. Starters shall be three-pole with three melting alloy overload relays. Overload heaters shall be coordinated with Division 23. Thermal units shall be of one-piece construction and interchangeable. Starter shall be inoperative with any thermal unit removed. The disconnect operating handle shall be position indicating.
    - a. Provide a control device and pilot light on the cover of each combination starter. Control devices for motors with remote manual or automatic control shall be "hand-off-auto" switches. Control devices for locally controlled motors shall be "start-stop" pushbuttons.
    - b. 120-volt magnetic motor starters may consist of a circuit breaker or fused disconnect switch and a magnetic starter in separate enclosures mounted next to each other.

- c. Control circuits shall operate at a maximum of 120 volts. Provide control transformers as required.
3. Starters shall be mounted within NEMA-1 enclosures unless specified otherwise.
4. All starters shall be lockable in the "off" position.
5. Overload heaters shall be sized for the motor nameplate full-load amperes per the manufacturer's recommendations.

M. Wiring Materials:

1. Wiring shall be enclosed in electrical rigid galvanized steel, intermediate metal conduit, or electrical metallic tubing sized in accordance with code requirements for the conductors. Type MC cable may be used where concealed in walls or ceilings and allowed by code.
  - a. Conduit fittings shall be steel. Use set-screw type in dry locations and compression type in damp or wet locations.
  - b. Terminations for all conduit shall have insulated bushings or insulated throat connectors in accordance with code requirements.
  - c. All conduits shall be substantially supported with approved clips or hangers spaced not to exceed ten feet on center. Minimum conduit size shall be 1/2".
2. Surface Metal Raceway: UL 5 listed.
  - a. Boxes and fittings for surface metal raceways shall be as recommended by the manufacturer.
  - b. Support clips for surface metal raceways shall be the concealed type, with attachment screws concealed behind the raceway.
3. Flexible Metal Conduit shall be used for all connections to motors and vibrating equipment and shall comply with Fed. Spec. WW-C-566.
4. Liquid-Tight Flexible Metal Conduit shall consist of flexible steel conduit with a liquid-tight PVC jacket over the conduit.
  - a. Fittings shall incorporate a threaded grounding cone, a steel or plastic compression ring, and a gland for tightening.
  - b. Liquid-tight flexible metal conduit shall be used in damp or wet locations when flexible metal conduit would otherwise be used.
  - c. Liquid-tight flexible metal conduit shall not penetrate the roof or exterior walls, and shall not be installed in lengths exceeding 72" except where necessary for flexibility.
5. All Wiring shall be type THW, XHHW, or THWN, UL labeled, copper conductors with 600-volt insulation, except as otherwise noted. Minimum size wire shall be No. 12 AWG.
6. Type MC Cable shall have minimum No. 12 AWG type THWN or XHHW insulated copper conductors with an internal bare or insulated copper ground wire.

N. Fire-Stop Material:

1. Fire-stopping material shall maintain its dimension and integrity while preventing the passage of flame, smoke, and gases under conditions of installation and use when exposed to the ASTM E 119 time-temperature curve for a time period equivalent to the rating of the assembly penetrated. Cotton waste shall not ignite when placed in contact with the non-fire side during the test. Fire-stopping material shall be noncombustible as defined by ASTM E 136; and in addition for insulation materials, melt point shall be a minimum of 1700°F for one-hour protection and 1850°F for two-hour protection.
2. Seals for floor, exterior wall, and roof shall also be watertight.

O. Panelboards:

1. Provide standard manufacturer products. All components of panelboards shall be the product and assembly of the same manufacturer. All similar units of all panelboards shall be of the same manufacturer.
2. All panels shall be dead front safety type.
3. All panelboards shall be completely factory assembled with molded case circuit breakers.
4. Panels shall have main breaker or main lugs, bus size, voltage, phase, and flush or surface mounting all as scheduled on the drawings. Panelboards to be used as service equipment shall be listed for such use.
5. Panelboards shall have the following features:
  - a. Non-reduced size copper or aluminum bus bars and connection straps bolted together and rigidly supported on molded insulators. Bus bar taps shall be arranged for sequence phasing of branch circuit devices.
  - b. Full size neutral bar mounted on insulated supports.
  - c. Ground bar with sufficient terminals for all grounding wires. The ground bar shall be insulated and isolated where called for on the drawings.
  - d. Buses braced for the available short-circuit current, but not less than scheduled and never less than 10,000 amperes symmetrical. All panelboards shall be fully rated. Series rated assemblies are not acceptable.
  - e. All breakers arranged so that it will be possible to substitute a two-pole breaker for two single pole breakers or a three-pole breaker for three single pole breakers when frame size is 100 amperes or less.
  - f. Design interior so that protective devices can be replaced without removing adjacent units, main bus connectors and without drilling or tapping.
  - g. Where designated, on panel schedule as "space", include all necessary bussing, device supports and connections. Provide blank cover for each space.
  - h. Provide galvanized steel cabinets to house panelboards. Cabinets for panelboards may be factory primed and suitably treated with a corrosion-resisting paint finish meeting UL standard for outdoor applications.
  - i. Back and sides shall be of one-piece formed steel. Cabinets for panelboards may be of formed sheet steel with end and side panels welded, riveted or bolted as required.
  - j. Provide minimum of four interior mounted studs and necessary hardware for in and out adjustment of panel interior.
  - k. Fabricate trim of sheet steel consisting of frame with door attached by concealed hinges. Provide flush or surface trim as shown on the drawings.
  - l. Surface trim shall have the same width and height as the box.
  - m. Provide doors with flush type latch and manufacturer's standard lock.
  - n. In making switching devices accessible, doors shall not uncover any live parts.

- o. Provide concealed butt hinges welded to the doors and trims.
- p. Provide keyed alike system for all panelboards.
- q. Provide a directory card, metal holder, and transparent cover. Permanently mount holders on inside of doors.
- r. Circuit breakers in panelboards shall be bolt on type on phase bus bar or branch circuit bar. Molded case circuit breakers shall have automatic, trip free, non-adjustable, inverse time, and instantaneous magnetic trips.

P. Transient Voltage Surge Suppressors (TVSS):

- 1. Provide factory installed integral TVSS in panels where scheduled or indicated on the drawings. Field installed units shall not be acceptable.
- 2. UL Listed, UL1449.
- 3. Noise: less than 45 dBA at 5 feet.
- 4. 3 phase, 4 wire plus ground.
- 5. Dedication Modes:
  - a. Line to ground (L-G)
  - b. Line to Line (L-L)
  - c. Neutral to Ground (N-G)
  - d. Line to Neutral (L-N)
- 6. Category C with 8 x 20 microsecond waveform.
- 7. Joule rating shall meet or exceed ANSI/IEEE C62.41.
- 8. 5 year warranty from shipping data against part failure.
- 9. Quality Assurance
  - a. The specified system shall be thoroughly factory tested before shipment. Testing of each system shall include, but shall not be limited to, quality control checks, "Hi-Pot" tests at two times rated voltage plus 1000 volts per UL requirements, IEEE C62.41 Category B surge tests, UL ground leakage test, and operational and calibration tests.
  - b. The product shall be life cycle tested following suggested wait times as defined by ANSI/IEEE C62.45 and shall be capable of surviving 1000 sequential Category B surges of 10,000 Amps without failure.
  - c. The TVSS shall be provided with computer-generated graphs or oscillograms demonstrating the TVSS clamping voltage and operability. This test shall follow procedures outlined in ANSI/IEEE C62.45 for the installation category and applicable protection modes of the TVSS.

Q. Circuit Breakers: Circuit breakers to be added to existing panelboards shall match existing circuit breakers.

R. Grounding Conductors:

- 1. Grounding conductors shall be soft-drawn bare copper.
- 2. Insulated grounding wires shall be UL and NEC approved types, copper, with THWN or XHHW insulation color identified green, except where otherwise shown on the drawings or specified.
- 3. Wire shall not be less than shown on the drawings and not less than required by the NEC.

## S. Ground Clamps:

1. Ground clamps shall be cast bronze or cast copper and shall be UL listed for grounding connections.
2. Ground clamps shall be sized for the specific conductor and electrode to be clamped.

## T. Equipment Grounding Connections: Connections shall be of the compression type solderless connectors.

## U. Fire Alarm System Components:

1. Fire alarm system components shall be compatible and listed for use with the existing fire alarm system, and shall match existing similar devices or be the system manufacturer's current recommended replacement for existing similar devices.
2. Fire Alarm Control Panel: Provide all necessary common components, power supply, battery charger, batteries, programming, etc. as required to support the addition of components provided under this section for completion of a totally operational fire alarm panel.
3. Voice/Tone Notification Appliances:
  - a. Comply with UL 1480.
  - b. Speakers for Voice Notification: Locate speakers for voice notification to provide the intelligibility requirements of the "Notification Appliances" and "Emergency Communications Systems" chapters in NFPA 72.
  - c. High-Range Units: Rated 2 to 15 W.
  - d. Low-Range Units: Rated 1 to 2 W.
  - e. Mounting: Flush.
  - f. Matching Transformers: Tap range matched to acoustical environment of speaker location.
4. Strobe lights shall meet the requirements of the ADA, UL Standard 1971 and shall meet the following criteria:
  - a. Strobes shall be multi-candela rated and intensity shall be field selectable.
  - b. The maximum pulse duration shall be 2/10 of one second. Clear Lexan lens in housing.
  - c. Strobe intensity shall meet the requirements of UL 1971.
  - d. The flash rate shall meet the requirements of UL 1971.
  - e. Strobes in the same area shall be synchronized.
  - f. Outdoor units shall be weatherproof as well as any indicated on plans to be weatherproof that are inside the building.
5. Audible/Visual Combination Devices:
  - a. Shall meet the audibility requirements specified herein voice/tone notification appliances.



- b. Shall meet the visibility requirements specified for strobes.
6. Addressable Devices - General:
- a. Addressable devices shall provide an address-setting means using rotary decimal switches.
  - b. Addressable devices shall use simple to install and maintain decade (numbered 0 to 9) type address switches. Devices which use a binary address or special tools for setting the device address, such as a dip switch are not an allowable substitute.
  - c. Detectors shall be analog and addressable, and shall be capable of sensitivity adjustment through field programming of the system and automatically adjusted by the panel on a time-of-day basis.
  - d. Addressable smoke and thermal detectors shall provide dual (2) status LEDs. Both LEDs shall flash under normal conditions, indicating that the detector is operational and in regular communication with the control panel, and both LEDs shall be placed into steady illumination by the control panel, indicating that an alarm condition has been detected.
  - e. Using software in the FACP, detectors shall automatically compensate for dust accumulation and other slow environmental changes that may affect their performance. The detectors shall be listed by UL as meeting the calibrated sensitivity test requirements of NFPA Standard 72, Chapter 7.
  - f. The detectors shall be ceiling-mount and shall include a separate twist-lock base which includes a tamper proof feature.
  - g. The following auxiliary functions shall be provided where indicated on the drawings, and where required by code:
    - 1) Form-C Relay base rated 30VDC, 2.0A
    - 2) Auxiliary relay for HVAC shutdown.
  - h. The detectors shall provide a test means whereby they will simulate an alarm condition and report that condition to the control panel. Such a test may be initiated at the detector itself (by activating a magnetic switch) or initiated remotely on command from the control panel.
  - i. Detectors shall also store an internal identifying type code that the control panel shall use to identify the type of device (ION, PHOTO, THERMAL).
7. Addressable Pull Box (manual station):
- a. Addressable pull boxes shall, on command from the control panel, send data to the panel representing the state of the manual switch and the addressable communication module status. They shall use a key operated test-reset lock, and shall be designed so that after actual emergency operation, they cannot be restored to normal use except by the use of a key. Units shall be supplied with plastic tamper covers that produce an audible alarm when lifted.
  - b. All operated stations shall have a positive, visual indication of operation.
  - c. Manual stations shall be constructed of metal with clearly visible operating instructions provided on the cover. The word FIRE shall appear on the front of the stations in raised letters.

8. Intelligent Photoelectric Smoke Detector:
  - a. The detectors shall use the photoelectric (light-scattering) principal to measure smoke density and shall, on command from the control panel, send data to the panel representing the analog level of smoke density.
9. Intelligent Thermal Detectors:
  - a. Thermal detectors shall be intelligent addressable devices rated at 190 degrees Fahrenheit (except as otherwise indicated) and have a rate-of-rise element rated at 15 degrees F (9.4 degrees C) per minute. It shall connect via two wires to the fire alarm control panel signaling line circuit.
10. Intelligent Duct Smoke Detector:
  - a. The duct smoke detector housing shall accommodate an intelligent ionization detector that provides continuous analog monitoring and alarm verification from the panel.
  - b. When sufficient smoke is sensed, an alarm signal is initiated at the FACP, and appropriate action taken to change over air handling systems to help prevent the rapid distribution of toxic smoke and fire gases throughout the areas served by the duct system.
  - c. Provide sampling tubes as required by the ductwork.
  - d. Provide remote test/indicator stations where indicated. Provide engraved nameplate with HVAC unit designation for each station.
  - e. The detector shall use the photoelectric principal to sense products-of-combustion and report the measured level of such products to the control panel.
11. Provide addressable modules as required to monitor and control non-addressable devices such as solenoid valves, water flow switches, etc. indicated on the drawings and where required to provide a complete and operational system in accordance with the intent of the drawings and specifications. All shall be monitored separately.
12. Sprinkler and Standpipe Valve Supervisory Switches:
  - a. Valve supervisory switches shall be furnished and installed under Div. 21 and wired and connected under this section.
13. Conduit and Wire:
  - a. Wiring shall be in accordance with NEC Article 760, as shown on the drawings, and as recommended by the manufacturer of the fire alarm system. All wires shall be color-coded. Exposed wiring in unfinished areas shall be installed in metal conduit. Conduit fill shall not exceed 40 percent of interior cross sectional area. Number and size of conductors shall be as recommended by the fire alarm system manufacturer. Conduit shall be 1/2" minimum. Type FPLP cable shall be permitted where concealed and acceptable to the Authority Having Jurisdiction.

- b. Wires in junction boxes and cabinets shall be permanently tagged and identified with tags.
  14. Terminal Boxes, Junction Boxes and Cabinets:
    - a. Shall be galvanized steel in accordance with UL.
    - b. Paint red and identify with white markings as "Fire".
  15. Junction boxes shall have a volume 40 percent greater than required by the NEC. Minimum sized wire shall be considered as 14 AWG for calculation purposes.
- V. Dry Type Transformers:
1. Transformers shall have 150, 185 and 220<sup>0</sup> C insulation and be designed not to exceed 80, 115 and 150<sup>0</sup> C rise above 40<sup>0</sup> C ambient under full load conditions. Insulation systems shall be UL listed. Cores shall be manufactured from high-grade, non-aging, silicon steel with high magnetic permeabilities, low hysteresis and eddy current losses, and shall be clamped with structural angles and bolted to the enclosure to prevent damage during shipment or rough handling (remove clamping after installation). Coils shall be vacuum impregnated with non-hydroscopic thermosetting varnish and shall have a final wrap of electrical insulating material designed to prevent injury to the magnet wire. Transformers having coils with magnet wire visible will not be acceptable. Transformer shall have two 2-1/2% taps above and below normal voltage. Provide lugs to receive primary and secondary conductors.
  2. Ratings shall be as indicated on the drawings.

## PART 3 - EXECUTION

### 3.1 INSTALLATION

#### A. General:

1. All work shall be in accordance with the National Electrical Code's requirements as amended to date, with the local electric utility company's rules, the Fire Underwriter's requirements, and all local, state and federal laws and regulations.
2. In general, all wiring in finished areas shall be concealed in walls or above ceilings. Where wiring cannot be concealed due to existing construction, exposed wiring shall be installed in conduit or surface metal raceway as indicated on the drawings. Exposed wiring shall not be installed in finished areas without prior written authorization from the Engineer.
3. Conduits shall be of sizes required by the National Electrical Code. Exposed conduits shall be installed with runs parallel or perpendicular to walls and ceiling, with right-angle turns consisting of bends, fittings, or outlet boxes. No wire shall be installed until work that might cause damage to wires or conduits has been completed. Conduits shall be thoroughly cleaned of water or other foreign matter before wire is installed.

4. Where conduits, wireways and other electrical raceways pass through fire partitions, fire walls, or floor, install a fire-stop that provides an effective barrier against the spread of fire, smoke and gases. Fire-stop material shall be packed tight and completely fill clearances between raceways and openings. Floor, exterior wall, and roof seals shall also be made watertight.
5. Surface metal raceways shall be sized as required by the National Electrical code and as recommended by the manufacturer. Surface metal raceways shall be installed with runs parallel or perpendicular to walls and ceiling. Changes in direction shall only be made at device box locations or with fittings designed for the particular application. Installation shall be as visually unobtrusive as possible:
  - a. Surface metal raceways shall be painted to match wall finishes.
6. All splices shall be mechanically and electrically perfect, using crimp type wire connectors.
7. Provide all disconnect switches required by the N.E.C.
8. Locate motor starters as shown on drawings.
9. Mount disconnect switches and starters at a height of 60" above finished floor unless otherwise noted.
10. Provide all necessary hardware for mounting motor starters.
11. Locate panelboards so that the present and future conduits can be conveniently connected.
12. A typewritten schedule of circuits, approved by the Owner's Representative shall be on the panel directory cards. Type the room numbers and items served on the cards. Three-complete separate copies of all directories, neatly bound, shall be delivered to the Owner's Representative.
13. Revise existing panelboard directories. Furnish new cards as needed. Directories shall be typewritten or printed using a computer.
14. Mount the panelboard so that maximum height of circuit breakers above finished floor shall not exceed 78".
15. Circuit numbers indicated on the drawings are the actual numbers assigned to the circuit in the panelboard and shall not be varied without the consent of the Architect/Engineer.
16. Provide all necessary hardware for mounting panelboards.
17. Feeder circuit wiring shall be in conduit or EMT.
18. In general, conductors shall be the same size from the last protective device to the load and shall have an ampacity the same as or greater than the ampacity of the protective device where the wire size is not shown on the drawings. Use the 60°C ampacity rating for wire sizes No. 12 through No. 1. For 120V circuits, home runs longer than 100 feet shall be minimum No. 10 AWG, longer than 200 feet shall be minimum No. 8 AWG.

B. Grounding:

1. The entire electrical system shall be permanently and effectively grounded in accordance with Code requirements.
2. Connections to junction boxes, equipment frames, etc., shall be bolted.
3. Conduit Systems:
  - a. Ground all metallic conduit systems.

- b. Conduit systems shall contain a grounding conductor sized per NEC Table 250-122 or as shown on the drawings. Increase conduit size where necessary to accommodate the grounding conductor.
  4. Feeders and Branch Circuits: Install green grounding conductors with all feeders and branch circuits.
  5. Lighting Fixtures: Conduits shall not be used for grounding fixtures. Green equipment grounding conductor must be bonded to all fixtures.
- C. Alterations:
  1. The Contractor shall study all drawings and specifications, visit the site, and acquaint himself with the existing conditions and the requirements of the plans and specifications. No claim will be recognized for extra compensation due to the failure of the Contractor to familiarize himself with the conditions and extent of the proposed work.
  2. The Contractor shall execute all alterations, additions, removals, relocations or new work, etc., as indicated or required to provide a complete installation in accordance with the intent of the drawing and specifications.
  3. Reconnect existing circuits to remain. Remove existing equipment to be discontinued.
  4. Any existing work disturbed or damaged by the alterations or new work shall be repaired or replaced to the Engineer's satisfaction.
  5. Equipment relocated or removed and reinstalled shall be cleaned and repaired to a first-class condition before reinstallation.
- D. Fire Alarm System Installation:
  1. Installation shall be in accordance with the NEC Article 760, and the Americans with Disabilities Act and as shown on the drawings.
  2. Installation shall be as shown on the drawings and on the manufacturer's wiring diagrams, and shall be performed under the supervision of a factory-trained representative.
  3. All wiring shall be one wire per terminal to insure supervision. Crimp-on connectors shall not be used.
  4. All wiring shall be color-coded and tagged and shall be checked for continuity, short circuiting, and resistance to ground.
  5. All fire alarm wiring shall be installed in raceways.
  6. A factory-trained technician shall be present during testing and final inspection and shall instruct the Owner in system operation.
  7. Splices and taps: Use numbered terminal strips in junction, pull, and outlet boxes; cabinets; or equipment enclosures where circuit connections are made.
  8. Mounting Heights:
    - a. Manual Stations: 48" AFF
    - b. Visual Units: 80" above the highest floor level within the space or 6 in (152 mm) below the ceiling, whichever is lower.
  9. Tests:
    - a. Provide the service of a competent, factory-trained engineer or technician authorized by the manufacturer of the fire alarm equipment to technically

- supervise and participate during all of the adjustments and tests for the system. Make all adjustments and tests in the presence of the Owner's Representative.
- b. When the systems have been completed and prior to the final inspection, furnish testing equipment and perform the following tests in the presence of the Owner's Representative.
- 1) Before energizing the cables and wires, check for correct connections and test for short circuits, ground faults, continuity, and insulation.
  - 2) Test the insulation on all installed cable and wiring by standard methods as recommended by the equipment manufacturer.
  - 3) Open fire alarm detector circuits to see if trouble signal actuates.
  - 4) Check installation, supervision, operation and sensitivity of smoke detectors as recommended by the manufacturer to ascertain that they will avoid false alarm signals and will function as specified.
  - 5) Perform any other tests recommended by the equipment manufacturer.
10. Final Inspection: At the final inspection a factory-trained representative of the manufacturer of the existing equipment shall demonstrate that the systems function properly in every respect. The demonstration shall be made in the presence of the Architect/Engineer.
- E. Continuity of Services: Arrange to execute work at such times and in such locations to provide uninterrupted service to the building or any of its sections. If necessary, temporary power shall be installed to provide for this condition. Authorization for interrupting service shall be obtained in writing from the Owner. Any interruption of normal supply shall be performed during an overtime period to be scheduled with the Owner. Cost for overtime work shall be included in the bid.
- F. Identification:
1. Provide tags on each end of all pulled wires giving location of other end.
  2. Provide phenolic nameplates for all panelboards, motor starters, disconnect switches (except switches located at motors), and duct smoke detector remote test/alarm-indicating stations.
  3. Label each receptacle faceplate using machine-printed thermal adhesive labels to indicate source panel and branch circuit. For receptacles connected to normal power, labels shall be white with black letters. For receptacles connected to circuits from operational standby (OS) panels, labels shall be red with white letters.
- G. Record Drawings: The Contractor shall keep on the job a set of prints showing any changes to the installation. These shall be given to the Engineer at the completion of the work.
- H. Testing and Adjusting:
1. The entire installation shall be free from short-circuits and improper grounds. Tests shall be made in the presence of the Engineer or his representatives.
  2. Each individual lighting circuit shall be tested at the panel; and in testing for insulation resistance to ground, the lighting equipment shall be connected for proper operation. In no case shall the insulation resistance be less than that required by the National Electrical Code. Failures shall be corrected in a manner satisfactory to the Architect/Engineer.

3. Each system shall be completely tested and shall be adjusted for proper operation as required by the Engineer.
  - I. Instruction: Furnish the services of a competent instructor for not less than four hours on site for instructing personnel in the operation and maintenance of the fire alarm system.

END OF SECTION 261000





# DUO T-Bar

Verrill Dana Offices

**ARON™**

Light Delivered™

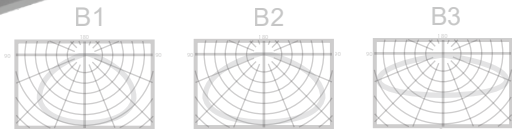
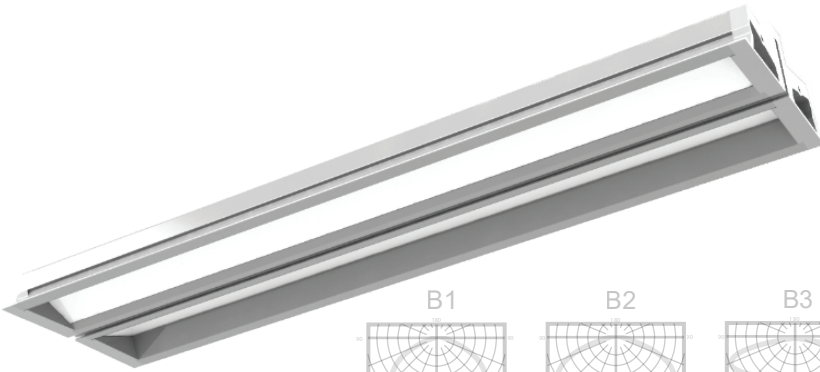
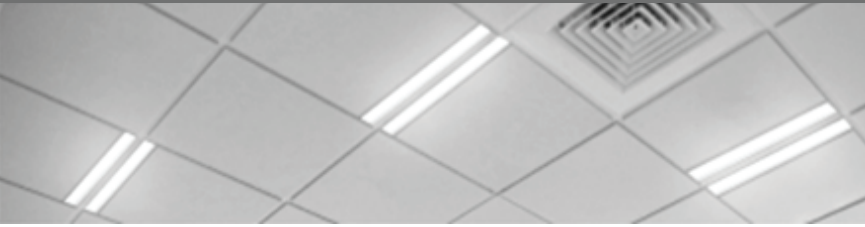

Date:

Job Name:

Type:

**DUO T-Bar**, recessed fixture. Designed with architectural appeal, high efficacy levels, perfected beam performance and easy installation. The DUO T-Bar recessed fixture simplifies installation with a light weight design using only a 6" emitting area and shallow depth for easy integration onto an existing T-Bar grid system.

5 Year Warranty  
IP, Patent Pending



## Ordering Code:

## Ordering Guide

Sample Number: DuoT1-2FA-2500-B1-3000K-80-UNV-DM

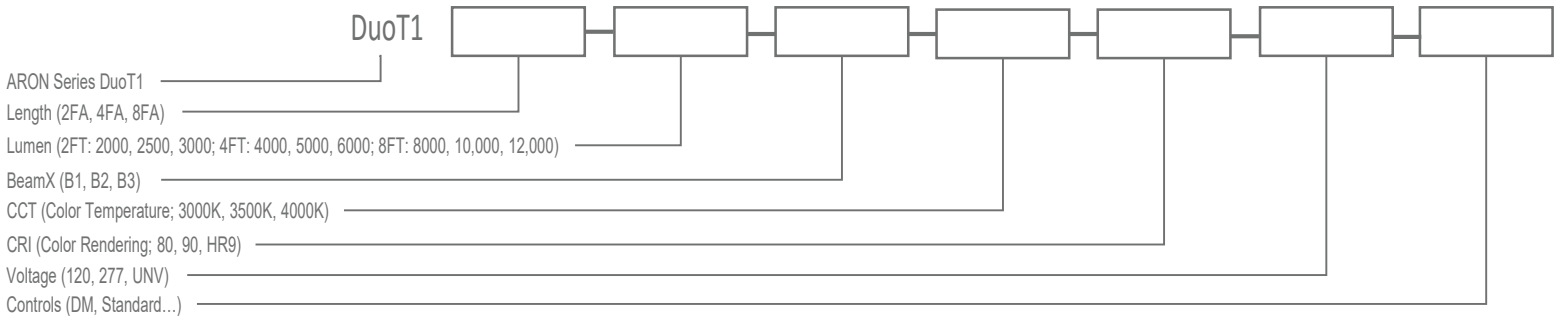

## Construction

- Extruded aluminum housing
- Injection Molded ABS endcaps
- Powder coated paint
- Designed to mate with 9/16, 15/16 and T-Slot grid ceiling system

## Optical

- Choice of multiple beam distributions using BeamX™ platform
- MicroTEK™ PMMA light guide
- Minimum 80 or 90 CRI
- ColorSure™ - Choice of CCT, high CRI and R9, with 3 step or less MacAdam ellipse.

## Electrical

- Class 2 constant current driver
- 0-10V dimming standard
- Additional dimming options:
- 0-10V Dimming (1%)
- 0-10 Dimming (10%-5%)
- Lutron Hi-Lume A Series (E1-E2)
- IOTA EM ILB-SL-CP10
- IOTA EM ILB-SL-CP12

Designed and manufactured in USA  
ARON Lighting//www.aronlighting.com

April 13, 2016  
2016 ARON Lighting

**ARON™**

**Greg Day Lighting**

Disclaimer: ARON Lighting reserves the right to make any design changes for continuous improvement which will not affect the overall appearance, pricing. All ceilings are to be adequately reinforced by others before installation. All fixtures are to be wired by a Type A electrician. This information is property of ARON Lighting and the information it contains may not be used without any written consent from ARON Lighting.

# DUO T-Bar

Verrill Dana Offices

# ARON™

Light Delivered™

## Optical Performance

### BeamX™ Distribution

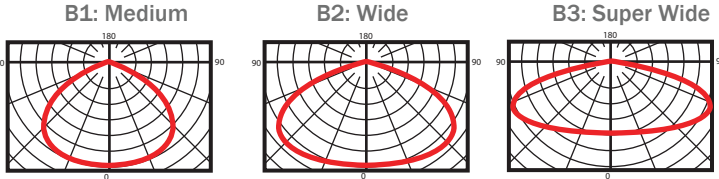

Lumens	Watts	Efficacy
2000	18 W	107 lm/W
2500	25 W	105 lm/W
3000	30 W	105 lm/W
4000	36 W	105 lm/W
5000	44 W	105 lm/W
6000	56 W	107 lm/W
8000	79 W	101 lm/W
10000	102 W	98 lm/W
12000	121 W	96 lm/W

## Example Application

**Model:** DuoT1-2FA-2500-B2-3000K-80-DM

2x2 Fluorescent troffer replacement

**Total Lumens:** 2547 lm

**Input Watts:** 24.69 W

**Efficacy:** 103.2 lm/W

**CCT/CRI:** 3105K/82.5

**L70 Reported** >36,000

**L70 Projected** 229,000+

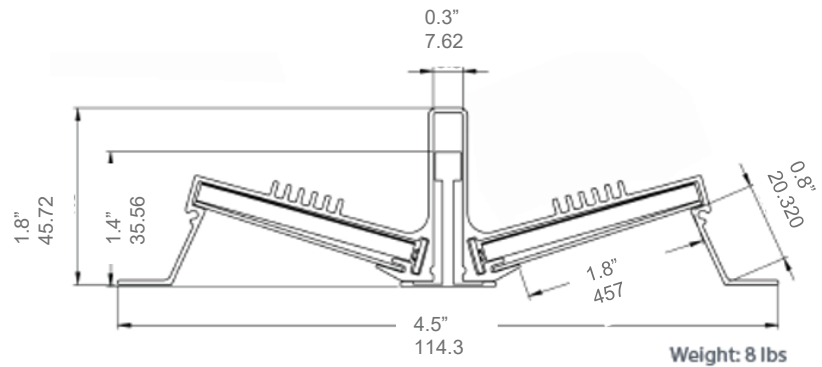

## Application Sizes

### Sizes

2FA = 23.75"

4FA = 47.75"

8FA = 95.75"

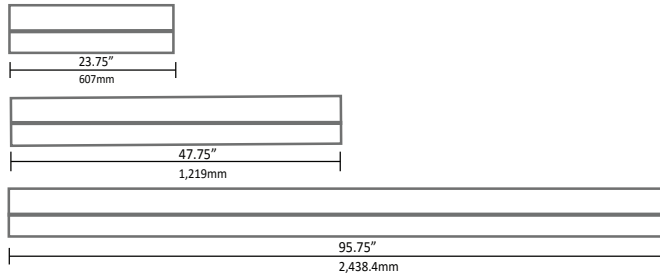

### Zonal Lumen

Zone	Lumens	% of Luminaire
0-40	909	35.7%
0-60	1805	70.9%
0-90	2547	100.0%
90-180	0	0.0%

### Candela

Zone	Lumens	% of Luminaire	Zone	Lumens	% of Luminaire
0-5	15.4	0.6%	60-65	219.7	8.6%
5-10	46.0	1.8%	65-70	198.4	7.8%
10-15	75.9	3.0%	70-75	163.0	6.4%
15-20	104.5	4.1%	75-80	110.6	4.3%
20-25	131.6	5.2%	80-85	41.5	1.6%
25-30	156.6	6.1%	85-90	8.8	0.3%
30-35	179.4	7.0%	90-95	0	0.0%
35-40	199.3	7.8%	95-100	0	0.0%
40-45	214.7	8.4%	100-105	0	0.0%
45-50	224.7	8.8%	105-110	0	0.0%
50-55	229.2	9.0%	110-115	0	0.0%
55-60	228.0	9.0%	115-120	0	0.0%

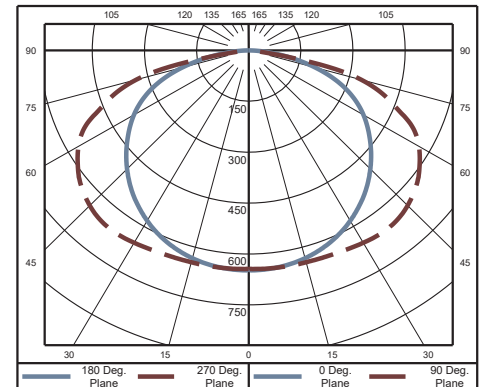

Featured Beam2 Wide (120°)

### Cone of Light Tabulation

Mounting Height (Ft)	Footcandles at Nadir	Diameter (Ft)
4.00	40.3	5.75
6.00	17.9	8.63
8.00	10.1	11.5
10.0	6.44	14.4
12.0	4.48	17.3
14.0	3.29	20.1
16.0	2.52	23.0

### Spacing Criteria

0-180	1.34
90-270	1.34

Designed and manufactured in USA  
ARON Lighting // www.aronlighting.com

Testing was performed in accordance with LM-79-08

April 13, 2016  
2016 ARON Lighting

ARON™

Greg Day Lighting

Disclaimer: ARON Lighting reserves the right to make any design changes for continuous improvement which will not affect the overall appearance, performance, or safety of the product. All ceilings are to be adequately reinforced by others before installation. All fixtures are to be wired by a certified electrician. This information is property of ARON Lighting and the information it contains may not be used without any written consent from ARON Lighting.

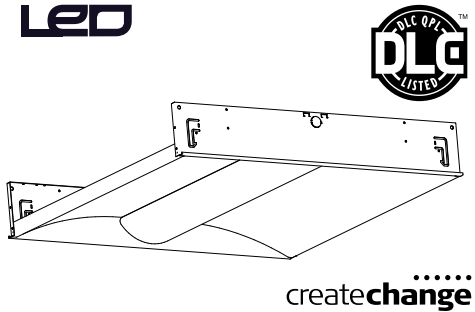

createchange

**FEATURES**

- Attractive architectural center lens
- High efficiency acrylic center lens features linear prisms for high performance without pixelation
- Appropriate for offices, schools, medical, and public spaces
- High performance reflector with matte white paint standard
- 60,000 hour LEDs at L80 (up to 150,000 projected life) for reduced maintenance
- Four LED color choices and 80 CRI
- Six lumen packages
- Multiple driver options to satisfy different applications
- LED modules and electrical accessible from below
- Optional architecturally styled integration of daylight and occupancy sensor(s)
- QR code traceability
- Integral battery pack optional on most models
- Compatible with Dual-Lite inverters
- Recessed, surface or cable mount
- Air return option
- DesignLights Consortium® (DLC) qualified
- Five year warranty (Terms and Conditions apply)

**PROJECT INFORMATION**

Project Name \_\_\_\_\_

Type \_\_\_\_\_

Catalog No. \_\_\_\_\_

Date \_\_\_\_\_

**CONSTRUCTION**

Luminaire housing, reflectors and end caps are die formed code gauge cold rolled steel. High transmission extruded acrylic enclosed lens features linear prisms with custom frost for high efficacy without pixelation.

**SHIELDING**

Removable lens for easy access to LED module and electrical components.

**FINISH**

All reflective surfaces are finished after fabrication with unique formula high reflectivity matte white paint for soft, uniform indirect illumination.

**INSTALLATION**

An access plate is furnished with each luminaire for fast wiring access without the necessity to open the fixture or wireway.

**CEILING COMPATIBILITY**

Luminaire fits recessed exposed Grid ceilings (G); four integral NEC compliant T-bar clips are standard. Can be placed in Slot Grid (SG) style ceiling with regress 3/8" above ceiling plane. A Flange Kit (FK) accessory is available for recessed hard ceiling applications. Surface Mount (SM) option allows placement below ceiling plane. Cable Mount (CM) option allows product suspension below ceiling plane.

**CERTIFICATION**

All luminaires are built to UL1598 and 2108 standards, and bear appropriate CSA labels. Damp location label standard. Emergency-equipped fixtures labeled UL 924 and Dry Location unless specified. Adheres to LM79, LM80, and TM21 industry standards. DesignLights Consortium® (DLC) qualified. Please refer to the DLC website for specific product qualifications at www.designlights.org.

**IC RATING**

IC label is standard for recessed products. Note that IC label is void if product is installed on site with a combination of both step-dimming (ESD) driver plus through wiring or for air return fixtures.

**WARRANTY**

Five year warranty (Terms and Conditions apply).

**ORDERING INFORMATION**

**EXAMPLE LCAT22-35HLG-ESDU**

LCAT		22	-	-	-	U	-	
MODEL	COLOR TEMPERATURE	SIZE	LUMEN OUTPUT	CEILING TYPE	AIR FUNCTION	VOLTAGE	OPTIONS	
LCAT LED Contemporary Architectural Troffer	30 3000K 35 3500K 40 4000K 50 5000K	22 2' x 2'	VW Very Low Watt MW Medium Watt LW Low Watt ML Medium Lumen HL High Lumen VL Very High Lumen	G Grid Lay-in <sup>1</sup> SM Surface Mount <sup>2</sup> CM Cable Suspended Mount <sup>2,3</sup>	Blank Static A Air Return Side Slots	U 120V-277V 347 347V	ELL14 Emergency Battery Pack Installed, 1400 Lumens <sup>4,5</sup> C388 3-Wire Flex C488 4-Wire Flex C588 5-Wire Flex GLR Fast Blow Fuse NYC NYC Compliant EOR End of Row (SM and CM only. Provides end wiring access for continuous row mounting.) <sup>2</sup> INT Intermediate (SM and CM only. Provides ends with wiring access for continuous row mounting.) <sup>2</sup> CP Chicago Plenum ODP Occupancy and Daylight Sensors, Philips <sup>4,6</sup>	
<b>DRIVER</b>								
E Fixed Output ESD Step Dimming <sup>4</sup> ED 0-10V Dimming ED1 0-10V 1% Dimming <sup>5</sup> LUTH Lutron H Series 1% Dimming <sup>4,5</sup> LUT5 Lutron 5 Series 5% Dimming <sup>4,5</sup>								
<b>PRODUCT AVAILABILITY</b>								
SIZE	LUMEN PACKAGE	NOMINAL LUMENS	NOMINAL WATTS	LUMENS PER WATT				
22	VW	1600-1750	16	100-109				
22	MW	2150-2300	22	100-107				
22	LW	2650-3050	25	107-123				
22	ML	3200-3400	30	107-115				
22	HL	3550-4050	35	100-115				
22	VL	4000-4600	42	96-110				
<b>ACCESSORIES (ORDER SEPARATELY)</b>								
FK22 2' x 2' Single Flange Kit (Shipped separately)								
CM48Y2SC3F-KIT 48" Cable Mount Kit for 2' wide Cable Mount fixtures, 3 Wire								

See Product Availability Table below.

DRIVER AVAILABILITY TABLE						
	VW	MW	LW	ML	HL	VL
E	X	X	X	X	X	X
ED	X	X	X	X	X	X
ED1	X	X	X	X	X	X
ESD			X	X	X	X
LUT5		X	X	X	X	
LUTH		X	X	X	X	

Nominal lumen range represents 3000K through 5000K. Lumens vary according to color temperatures and other factors. See specific photometric test(s).

<sup>1</sup> For drywall, order G with Flange Kit Accessory.  
<sup>2</sup> Not available with Air Return (A) air function  
<sup>3</sup> Order hanger accessories separately.  
<sup>4</sup> Not available in 347V  
<sup>5</sup> For compatibility with Dual-Lite LiteGear® inverters, contact Hubbell Lighting Representative.  
<sup>6</sup> Only available with 0-10V Dimming (ED) Driver Option.  
For questions about configuration options, contact Hubbell Representative

**PHOTOMETRIC DATA**

Test LCAT22-35LWG-EDU 15681 Test Date 1/9/2015

**LUMINAIRE DATA**

Luminaire	LCAT22-35LWG-EDU LCAT Led Architectural Troffer, Recessed Architectural 2 x 2 led with frosted linear prism lens
Ballast	XI040C110V054BPT1
Ballast Factor	1.00
Lamp	LED
Fixture Lumens	2784
Watts	25.00
Mounting	Recessed
Shielding Angle	0° = 90 90° = 90
Spacing Criterion	0° = 1.20 90° = 1.33
Luminous Opening in Feet	Length: 1.92 Width: 1.92 Height: 0.00

**ZONAL LUMEN SUMMARY**

Zone	Lumens	% Lamp	% Fixt.
0-30	706	25.4	25.4
0-40	1158	41.6	41.6
0-60	2067	74.2	74.2
0-90	2784	100.0	100.0
0-180	2784	100.0	100.0

**ENERGY DATA**

Total Luminaire Efficiency	100.0%
Total Lumens per Watt	111
IESNA RP-1-2004 Compliance	Non-Compliant
Comparative Yearly Lighting Energy Cost per 1000 Lumens	\$2.16 based on 3000 hrs. and \$0.08 per KWH

**INDOOR CANDELA PLOT**

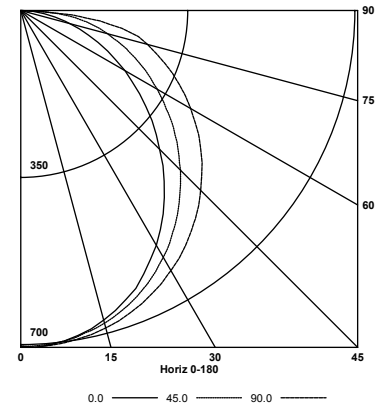

**LUMINAIRE DATA**

Luminaire	LCAT22-35MLG-EDU LCAT Led Architectural Troffer, Recessed Architectural 2 x 2 led with frosted linear prism lens
Ballast	D10CC55UNVTZ-C
Ballast Factor	1.00
Lamp	LED
Fixture Lumens	3261
Watts	30.20
Mounting	Recessed
Shielding Angle	0° = 90 90° = 90
Spacing Criterion	0° = 1.20 90° = 1.32
Luminous Opening in Feet	Length: 1.92 Width: 1.90 Height: 0.00

**ZONAL LUMEN SUMMARY**

Zone	Lumens	% Lamp	% Fixt.
0-30	825	25.3	25.3
0-40	1352	41.4	41.4
0-60	2415	74.0	74.0
0-90	3261	100.0	100.0
0-180	3261	100.0	100.0

**ENERGY DATA**

Total Luminaire Efficiency	100.0%
Total Lumens per Watt	108
IESNA RP-1-2004 Compliance	Non-Compliant
Comparative Yearly Lighting Energy Cost per 1000 Lumens	\$2.20 based on 3000 hrs. and \$0.08 per KWH

Test LCAT22-35MLG-EDU Test Date 1/20/2015

**INDOOR CANDELA PLOT**

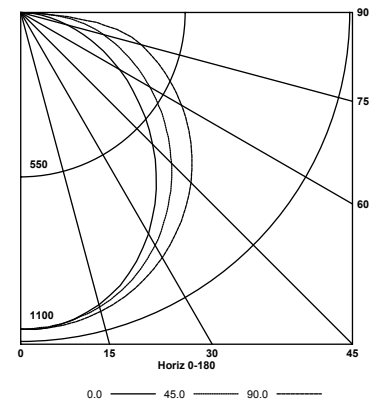

**LUMINAIRE DATA**

Luminaire	LCAT22-35HLG-EDU LCAT Led Architectural Troffer, Recessed Architectural 2 x 2 led with frosted linear prism lens
Ballast	D10CC55UNVTZ-C
Ballast Factor	1.00
Lamp	LED
Fixture Lumens	3685
Watts	35.40
Mounting	Recessed
Shielding Angle	0° = 90 90° = 90
Spacing Criterion	0° = 1.20 90° = 1.32
Luminous Opening in Feet	Length: 1.90 Width: 1.90 Height: 0.00

**ZONAL LUMEN SUMMARY**

Zone	Lumens	% Lamp	% Fixt.
0-30	934	25.3	25.3
0-40	1530	41.5	41.5
0-60	2732	74.1	74.1
0-90	3685	100.0	100.0
0-180	3685	100.0	100.0

**ENERGY DATA**

Total Luminaire Efficiency	100.0%
Total Lumens per Watt	104
ANSI/IESNA RP-1-2004 COMPLIANCE:	Non-Compliant
Comparative Yearly Lighting Energy Cost per 1000 Lumens	\$2.29 based on 3000 hrs. and \$0.08 per KWH

Test LCAT22-35HLG-EDU Test Date 2/13/2015

**INDOOR CANDELA PLOT**

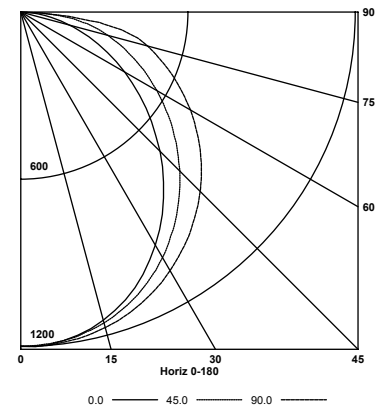

**DIMENSIONAL DATA — GRID, STATIC**

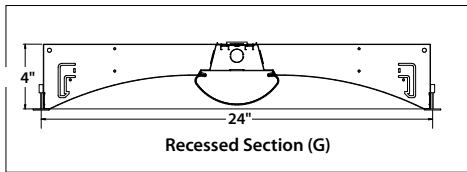

**GRID, STATIC**

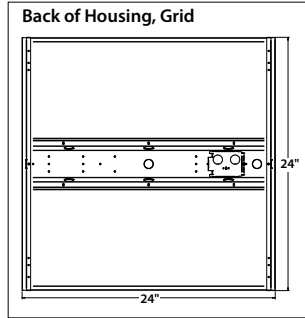
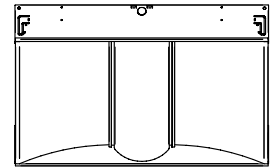
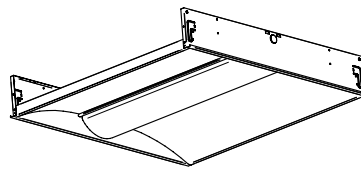

**GRID, AIR RETURN**

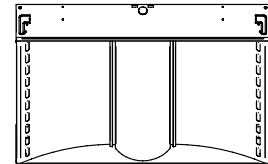
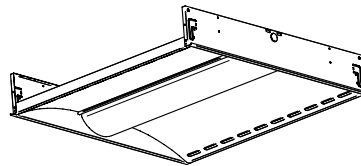

**CEILING COMPATIBILITY**

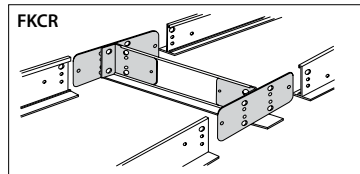
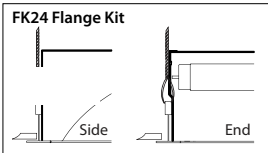
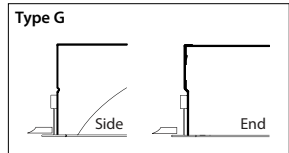

For lay-in installation in exposed grid ceilings. Maximum tee widths of 1" and maximum tee heights of 2" allowed.

For hard ceiling applications, order FK22 flange kit. Flange kit wires directly into concealed ceiling opening for a clean, finished appearance.

For flanged fixtures in row configurations, the FKCR adapter bracket kit is required in addition to the FK22 kit. Order one less FKCR than the total number of fixtures in row. (Example: Row of two, order (2) FK22 & (1) FKCR)

Row cut out dimensions using FK22s & FKCR adapters:  
Width 24<sup>3</sup>/<sub>8</sub>", Length [24" × (# in row)] + <sup>3</sup>/<sub>8</sub>".  
Example: (24" × 2) + <sup>3</sup>/<sub>8</sub>" = 48<sup>3</sup>/<sub>8</sub>"

**Flange kit cut out dimension for single unit only: 24<sup>3</sup>/<sub>8</sub>" × 24<sup>3</sup>/<sub>8</sub>"**

**DIMENSIONAL DATA — SURFACE MOUNT & CABLE MOUNT, STATIC ONLY**

**Surface Section (SM)**

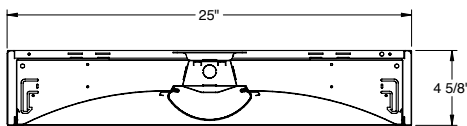

**Back of Housing, Surface Mount (SM) and Cable Mount (CM)**

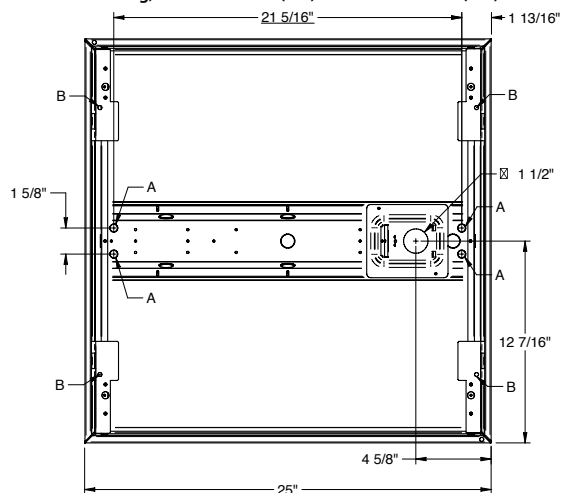

**Surface Mount:**

Order SM ceiling type. Mounting collar required for surface mounting. (4) Mounting knock-outs, <sup>3</sup>/<sub>8</sub>", provided in center channel as indicated at left, marked A.

**Cable Mount:**

Order CM ceiling type. Use CM48Y2SC3F-KIT 48" Cable Mount Kit for 2' wide CM fixtures. Mounting holes are provided in diagonal straps shown at left, marked B.

\* For Cable Mount a 2" x 3" access plate with (4) <sup>7</sup>/<sub>8</sub>" KOs provided in place of Mounting Collar shown.

**NOTE:** All dimensions are in inches; dimensions and specifications are subject to change without notice. Please consult factory or check sample for verification.

IC - RATED

LED



Verrill Dana Offices

# FINELITE

## High Performance 4" Aperture (HP-4) - Recessed



Date

Project

Type

Comments



### DESCRIPTION

High Performance 4" Aperture Recessed (HP-4 R) is a patented, linear LED luminaire. HP-4 R is the first recessed linear LED luminaire to feature On-Grid™ mounting for standard lengths, making installation quick and easy.

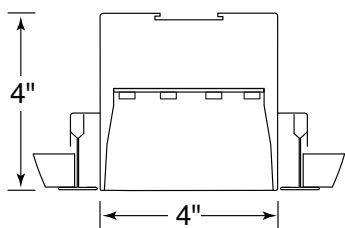

Flush Diffuser (Standard)

### DIMENSIONS & DIFFUSER

Glare-free experience is attained with mid-power LEDs and a precise diffuser to eliminate pixilation.

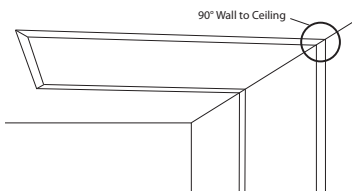

### MITERED ANGLES

Fully illuminated corners have internal secondary diffusers to ensure against light leaks. Custom angles are available.

# Tailored Lighting 10 working days

### TAILORED LIGHTING

Any length greater than 2 feet, in increments down to 1/16th-inch (± 1/32") and 90-degree mitered corners in a single plane.

### ORDERING GUIDE

Sample Number: HP-4 R - 32' - S - 8 - 35 - F - 120V - SC - C1 - OBO



### Finelite Series HP-4 R

Length (Minimum 2', increments accurate to 1/16th" (± 1/32"), standard)

Light Output (S - Standard Output, B - Boosted Standard Output, H - High Output, V - Very High Output)

LED CRI (8 - 80 CRI Min (standard), 9 - 90 CRI Min (optional))

LED Color Temperature (30 - 3000K, 35 - 3500K, 40 - 4000K)

Downlight Diffuser Option (F - Flush (standard))

Voltage (120V, 277V)

Circuiting (SC - Single Circuit)\*

Mounting (C1 - 1" T-Bar, C2 - 9/16" T-Bar, C3 - Screw Slot, C3F - Flush Screw Slot, VF - Visible Flange,

C2T - 9/16" Tegular, C1T - 1" Tegular, SF - Spackle Flange, TZ6 (C1, C2, C2T, C3, C3T) - Tech Zone 6")

Integrated Sensor (OBO - Occupancy Sensor, OBD - Daylight)

\*Contact factory for switching options.

Protected by one or more US Patents: 8915613; D702,391; D702,390; D700,732

Finelite, Inc. • 30500 Whipple Road • Union City, CA 94587-1530 • 510 / 441-1100 • Fax: 510 / 441-1510 • www.finelite.com

Due to continuing product improvements, Finelite reserves the right to change specifications without notice. Please visit www.finelite.com for most current data.





# FINELITE

## High Performance 4" Aperture (HP-4) - Recessed

### PHOTOMETRY

Very High Output - 4' Luminaire

Efficacy (Lumen per watt): 102.1

Total luminaire output: 3726 Lumens (932 lumens/foot)  
37.7 Watts (9.4 watts/foot)

Peak Candela Value: 1442 @ 0°

CCT: 3500K

ITL LM79 Report 85128

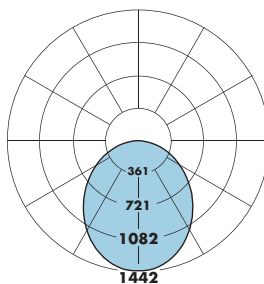

CANDLEPOWER SUMMARY

	0.0	22.5	45	67.5	90	Flux
0	1442	1442	1442	1442	1442	
5	1434	1434	1433	1433	1434	136
15	1369	1360	1365	1364	1359	384
25	1241	1226	1232	1225	1219	566
35	1064	1053	1055	1043	1037	657
45	864	853	851	840	834	655
55	650	644	640	631	626	571
65	441	436	433	428	425	428
75	238	237	238	237	236	252
85	70	69	70	72	71	78
90	0	0	0	0	0	

#### Total Light Output, 3500K, 80 CRI (Lumens) - 4' Luminaire

S*	B*	H*	V**
1525	1917	2898	3726

#### Light Output, 3500K, 80 CRI (Lumens Per Foot)

S*	B*	H*	V**
381	479	725	932

#### Power (Watts Per Foot)

S*	B*	H*	V**
3.6	4.6	7.1	9.3

#### Efficacy, 3500K, 80 CRI (Lumens Per Watt)

S*	B*	H*	V**
105.1	104.1	102.2	100.7

**S - Standard Output, B - Boosted Standard Output, H - High Output, V - Very High Output**

\* Family Correlation based on 4' luminaire 3500K Very High Output (V) test - 120V.

\*\* Correlation based on ITL report: 85128

#### Lumen Adjustment Factors - 80 CRI

<b>3000K</b>	0.985
<b>3500K</b>	1.000
<b>4000K</b>	1.032

#### Lumen Adjustment Factors - 90 CRI

<b>3000K</b>	0.746
<b>3500K</b>	0.760
<b>4000K</b>	0.789

Apply a lumen adjustment factor to calculate lumens for the desired CCT and CRI.

#### SAMPLE LUMEN ADJUSTMENT CALCULATION

Recessed (H), 4000K, 90 CRI

Lumen Adjustment Factor = 0.789

$$\text{Total Light Output} = 2898 \text{ lm} \times 0.789 = 2287 \text{ lm}$$

$$\text{Total Light Output per Foot} = 725 \text{ lm/ft} \times 0.789 = 572 \text{ lm/ft}$$

$$\text{watts/foot} = 7.1 \text{ W/ft}$$

$$\text{Efficacy} = \frac{572 \frac{\text{lm}}{\text{ft}}}{7.1 \frac{\text{W}}{\text{ft}}} = 80.1 \text{ lm/W}$$

Protected by one or more US Patents: 8915613; D702,391; D702,390; D700,732

Finelite, Inc. • 30500 Whipple Road • Union City, CA 94587-1530 • 510 / 441-1100 • Fax: 510 / 441-1510 • www.finelite.com

Due to continuing product improvements, Finelite reserves the right to change specifications without notice. Please visit www.finelite.com for most current data.



# FINELITE

## High Performance 4" Aperture (HP-4) - Recessed

### SPECIFICATIONS

**CONSTRUCTION:** Precision-cut 6061-T6 extruded aluminum body. Internal joiner system, plug-together wiring, standard. Housing is powder coated.

**ENDCAPS:** Flat endcaps add 0.05" to each end of luminaire.

**MITERED CORNERS:** Illuminated 90° corners in a single plane, with Flush downlight diffuser, standard. Custom angles are available (90° minimum on inside corners), contact factory.

**REFLECTORS:** Die-formed 20-gauge cold-rolled steel reflectors are finished in 96 LG high reflectance matte white powder coat paint.

**DOWNLIGHT DIFFUSER:** 12" maximum lens length. Flush frost white snap-in lens standard, 73% transmissive, 99% diffusion. Internal secondary diffusers at corners ensure visually seamless, uniform, continuous illumination. Frost white snap-in lens option, 73% transmissive, 99% diffusion.

**LIGHT OUTPUT:** Four lumen packages available, Standard Output (S), Boosted Standard Output (B), High Output (H), and Very High Output (V). A separate chart summarizes lumen distribution and wattage. Light engines are replaceable.

**LUMEN MAINTENANCE:** 90% of initial light output (L90) at 100,000+ hours; 70% of initial light output (L70) at 200,000+ hours.

**DRIVER:** Replaceable 120V/277V Constant Current Reduction dimming driver standard. Can be wired dimming or non-dimming. 0-10V dimming controls with a range of 10%- 100%. Dimming to 1% available; consult factory. Driver is fully accessible from below the ceiling. Power Factor:  $\geq 0.9$ . Total Harmonic Distortion (THD)  $< 20\%$ . Expected driver lifetime: 100,000 hours.

**LUTRON DRIVER OPTIONS:** Lut3W-3-wire, LutES-EcoSystem, Lut2W-2-wire.

**ELECTRICAL:** Optional emergency to generator/inverter wiring, internal generator transfer switch, nightlight wiring, step-dimming driver, backup battery. Factory-choice low-profile backup battery available. 8' minimum fixture length for low profile battery pack. Bodine BSL722 battery pack also available; 4' minimum fixture length. Backup battery delivers 1300 lumens. Half of a 4' section will be illuminated in emergency mode.



**INTEGRATED SENSORS:** Integrated PIR (Passive Infrared) occupancy and/or daylight sensors available with Flush downlight diffusers. Refer to Occupancy Sensor and Daylight Sensor tech sheets for more info.

**MOUNTING:** Standard bracket design works with most lay-in ceiling types. Brackets secure luminaire to the ceiling grid from above. Tie-in T-Bar brackets. Connect luminaire to T-Bar for securing to structure. Consult local codes for tie-wire recommendations.

**FEED:** Standard with one 18-gauge/5-conductor single-circuit feed. 14-gauge feed used when fixture current exceeds 5 amps. Optional 6' flex conduit whips available.

**LENGTHS:** Any length, 2-foot minimum, in increments down to 1/16th-inch ( $\pm 1/32$ ").

**LABELS:** Fixture and electrical components are ETL-listed conforming to UL 1598 in the U.S.A. and CAN/CSA C22.2 No. 250.0 in Canada. In accordance with NEC Code 410.73 (G), this luminaire contains an internal driver disconnect. Damp Location. IC-Rated. Finelite products use electronic components that are RoHS compliant, and the mechanical components of the luminaire have been verified to not knowingly contain any restricted substances listed per RoHS Directive 2002/95/EC.

**WEIGHT:** 2.8 lb/ft.

**WARRANTY:** 10-year performance-based warranty on all standard components. Optional accessories such as emergency battery packs are covered by their individual manufacturer warranties.

Protected by one or more US Patents: 8915613; D702,391; D702,390; D700,732

Finelite, Inc. • 30500 Whipple Road • Union City, CA 94587-1530 • 510 / 441-1100 • Fax: 510 / 441-1510 • [www.finelite.com](http://www.finelite.com)

Due to continuing product improvements, Finelite reserves the right to change specifications without notice. Please visit [www.finelite.com](http://www.finelite.com) for most current data.



# FINELITE

## High Performance 4" Aperture (HP-4) - Recessed

### MOUNTING TYPES: T-BAR

Rough-In Dimensions

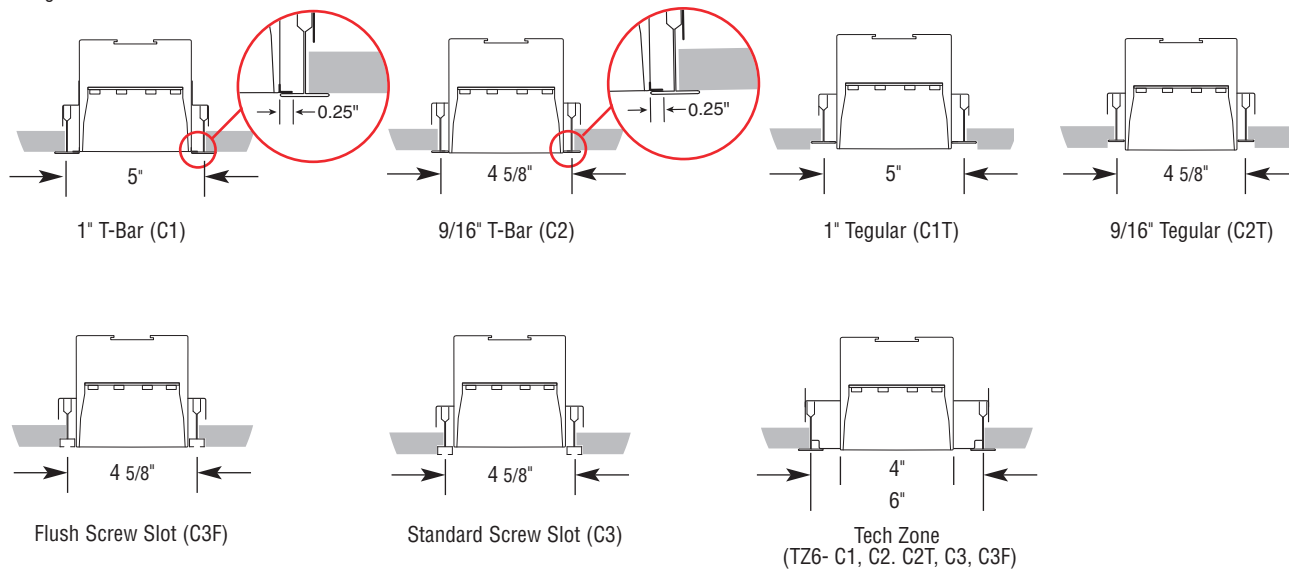

### MOUNTING TYPES: CUTOUT DIMENSIONS

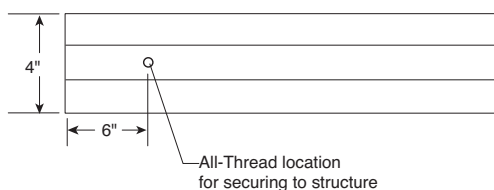
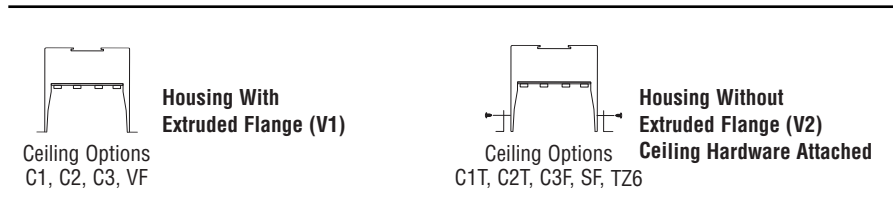
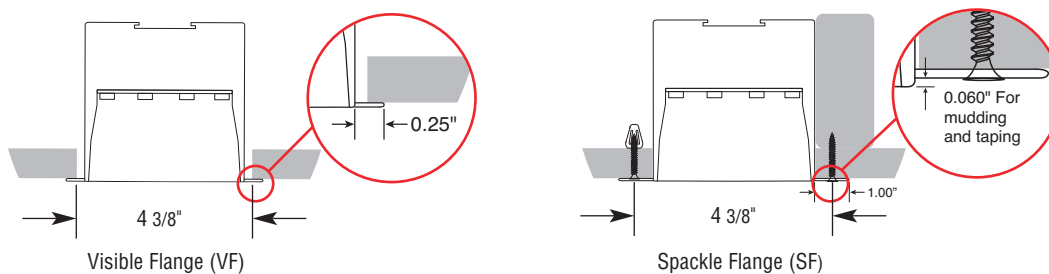

### SHEET ROCK INSTALLATION:

Flex conduit is secured to top of fixture. Support to structure using All-Thread. All-Thread support holes are located on each end of the fixture.

### T-BAR INSTALLATION:

HP-4 R for T-Bar installations comes standard with a splice plate at the end of the luminaire. Mounting brackets (supplied) secure the fixture to T-Bar and provide support to structure location. All starter/independent fixtures are 1 1/8" shorter than nominal. All joiner/ender fixture are normal length.

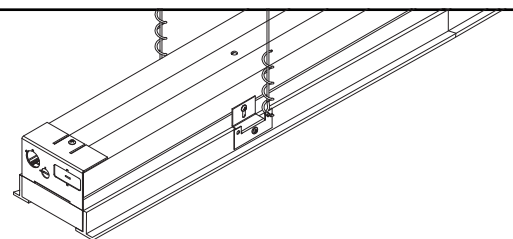

Protected by one or more US Patents: 8915613; D702,391; D702,390; D700,732

Finelite, Inc. • 30500 Whipple Road • Union City, CA 94587-1530 • 510 / 441-1100 • Fax: 510 / 441-1510 • www.finelite.com

Due to continuing product improvements, Finelite reserves the right to change specifications without notice. Please visit www.finelite.com for most current data.

**LED**

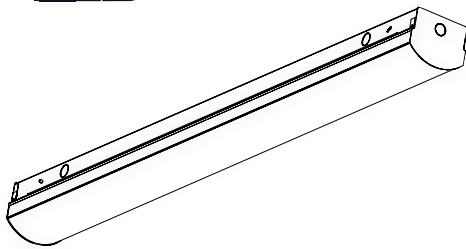

**FEATURES**

- LED technology in a lensed striplight
- Long life 50,000 hour LEDs at L80 for reduced maintenance
- Up to 110 lumens per watt
- Choice of four LED color temperatures
- Superior color consistency within a 3-step MacAdam ellipse and greater than 80 CRI
- Choice of four lumen packages per size
- Available in 2', 4' or 8' lengths
- Optional integral emergency battery pack
- Heavy die-formed steel channel
- Fully assembled fixture for quick installation
- LED boards and driver accessible for future maintenance or upgrades
- Modular replaceable LED components
- Surface mount or suspended
- Five year warranty

**PROJECT INFORMATION**

Project Name \_\_\_\_\_

Type \_\_\_\_\_

Catalog No. \_\_\_\_\_

Date \_\_\_\_\_

**CONSTRUCTION**

Housing, wireway, and ends are formed from code-gauge steel. Housing components act as heat sink for LED heat dissipation. Knockouts are provided for electrical access and mounting. Shielded with 100% frosted prismatic acrylic lens.

**CERTIFICATION**

All luminaires are built to UL 1598 and 2108 standards, and bear appropriate CSA c/US labels. Damp location labeling is standard. Emergency equipped fixtures labeled UL924. Adheres to LM70, LM80, and TM21 industry standards.

**FINISH**

White painted parts are treated with a five-stage phosphate bonding process and finished with high reflectance baked enamel. For a post-painted housing finish select PAF option.

**WARRANTY**

Five year warranty (Terms and Conditions apply).

**ELECTRICAL**

Long-life LEDs are rated for 50,000 hours at L80 lumen maintenance. Driver options include fixed output for on/off function, step dimming (high/low/off) or continuous 0-10V dimming.

**ORDERING INFORMATION**

**EXAMPLE LCL4-40HL-EU**

LCL					U	
MODEL	SIZE	COLOR TEMP	LUMEN OUTPUT	DRIVER	VOLTAGE	OPTIONS
LCL LED Striplight	2 2'	30 3000K	LW Low Watt	E Fixed Output	U 120V-277V	ELL14 Emergency Battery Pack, 1400 Lumens <sup>1,2</sup>
	4 4'	35 3500K	ML Medium Lumen	ESD Step Dimming		GLR Fast Blow Fuse
	8 8'	40 4000K	HL High Lumen	ED 0-10V Dimming		PAF Paint After Fabrication
		50 5000K	VL Very High Lumen			NYC NYC Compliant

See Product Availability Table below.

**ACCESSORIES (ORDER SEPARATELY)**

S18	18" Stem, Canopy
SS18	18" Swivel Stem—45° Swivel
CSHC	Chain Hanger Assembly

**PRODUCT AVAILABILITY**

SIZE	LUMEN PACKAGE	NOMINAL LUMENS (4000K)	NOMINAL EFFICACY WATTS	
2'	ML	2,500	26 100	
	4'	LW	2,500	25 100
		ML	5,000	48 104
HL		6,100	55 110	
8'	VL	10,100	96 105	
	LW	5,000	48 104	
	ML	10,100	96 105	
	HL	12,200	111 110	
	VL	20,100	193 104	

Lumens vary according to color temperature and other factors. See specific photometric test(s).

<sup>1</sup> For compatibility with Dual-Lite LiteGear<sup>®</sup> inverters in lieu of installed battery pack, contact Hubbell Lighting representative.  
<sup>2</sup> Not available in 2 ft size.

**PHOTOMETRIC DATA**

**LUMINAIRE DATA**

Luminaire	LCL4-40HL-ED LCL Led Lensed Utility Channel, Industrial 48" x 4½ x 3 13/16" LED with acrylic formed lens
Ballast	D15CC55UNVTC
Ballast Factor	1.00
Lamp	LED
Fixture Lumens	6078
Watts	54.70
Shielding Angle	0° = 90 90° = 90
Spacing Criterion	0° = 1.24 90° = 1.28
Luminous Opening in Feet	Length: 4.00 Width: 0.40 Height: 0.00

**ZONAL LUMEN SUMMARY**

Zone	Lumens	Lamp	Fixt.
0-30	1649	27.1	27.1
0-40	2679	44.1	44.1
0-60	4574	75.2	75.2
0-90	5860	96.4	96.4
0-180	6078	100.0	100.0

**ENERGY DATA**

Total Luminaire Efficiency	100.0
Total Lumens per Watt	111
ANSI/IESNA RP-1-2004 Compliance	Noncompliant
Comparative Yearly Lighting Energy Cost per 1000 Lumens	\$2.16 based on 3000 hrs. and \$0.08 per KWH

Test ITL15383 Test Date 7/14/14

**INDOOR CANDELA PLOT**

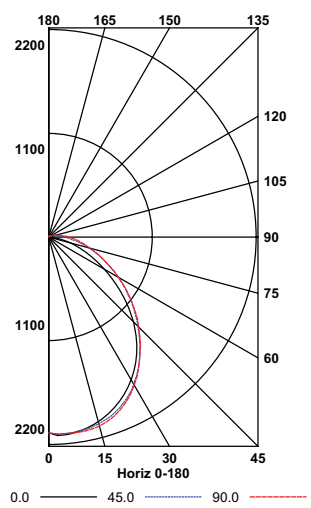

**DIMENSIONAL DATA**

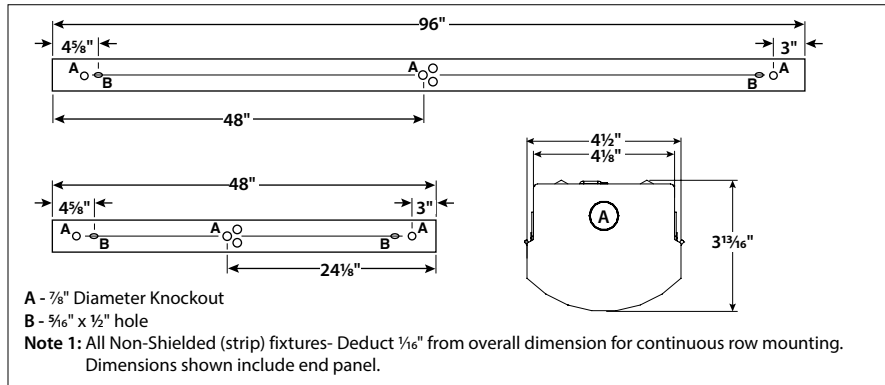

**MOUNTING ACCESSORIES**

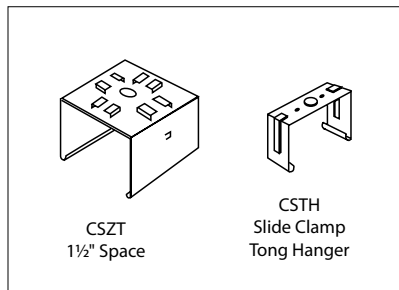

**NOTE:** All dimensions are in inches; dimensions and specifications are subject to change without notice. Please consult factory or check sample for verification.



# id+ 4.5" x 4.5"

LED DOWNLIGHT



white flange



black flange



titanium silver flange



clear diffuse



warm diffuse

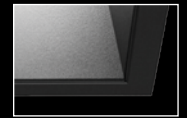

black reflector



white reflector



trimless companion

## DIMENSIONAL DATA

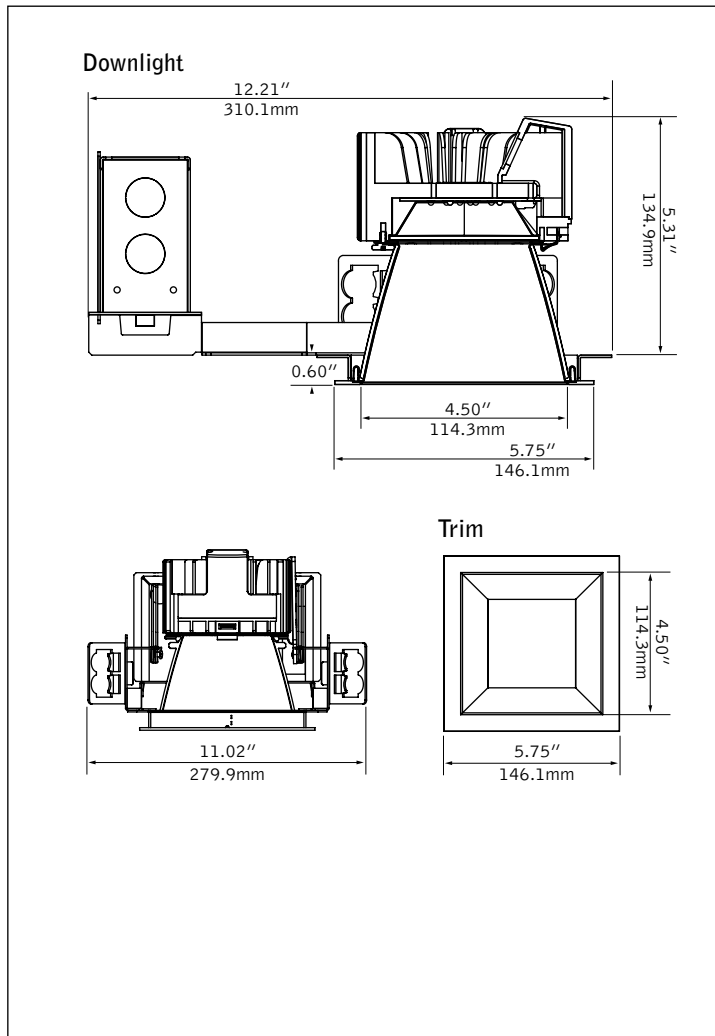

## FEATURES

ChromaSure: Color consistency resulting in a 2-step MacAdam ellipse across the entire ID+ product line.

Field adjustability of ceiling thickness from 0.5" - 2.5".

Shallow housing.

50 degree cutoff to light source and its image.

Selection of dimming drivers available.

Right Light: Standard delivered lumen outputs 1000, 1500, 2000, 2500 and 3000.

## PERFORMANCE

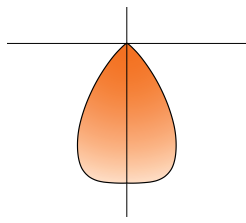

**PRODUCT OVERVIEW**

Lumen Output: 1000-3000lm

Wattage: 13-45W

LPW: 67-78

Spacing Criteria: 1.07- 1.11

SDCM: 2

Lumen Maintenance: L70 @ 63,000hrs

**Delivered Lumens: 2000lm**

**Total System Watts: 26W**

Photometric performance is measured in accordance with IESNA LM-79. Visit focalpointlights.com for complete photometric data. Visit energystar.gov for model specifics.

**HOUSING DETAILS**

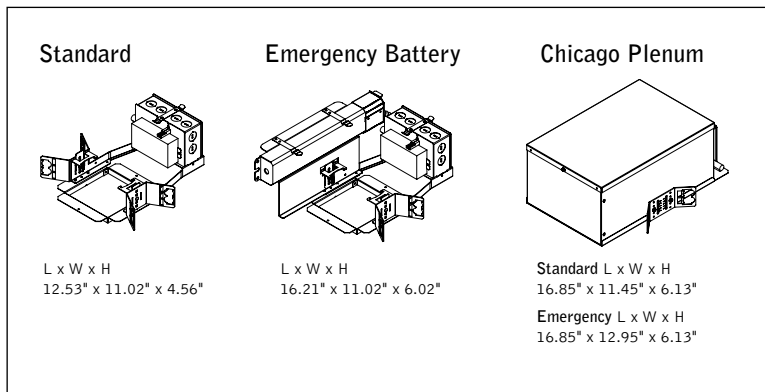

**HOUSING SPECIFICATIONS**

**Construction**

Thermally protected housing for new construction applications. Insulation to be kept 3" away from housing. Butterfly brackets allow mounting to 1/2 emt. Order bar hangers as an accessory. Die-cast aluminum heat sink designed for maximum thermal dissipation. Die-formed housing and integral junction box with (7) 1/2" pry outs. UL & cUL listed for (6) #14 AWG (3 in, 3 out) 90°C conductors and feed through-branch wiring. Accommodates ceiling thicknesses up to 0.5" standard, field adjustable up to 2.5" thickness. For thicker ceiling consult factory. Order TZB option for TechZone compatible housing brackets. Fixture will not exceed 5 lb.

**Electrical**

Choice of constant current dimming drivers. Power factor > .9 typical.

**Emergency**

Emergency Battery Pack: Bodine BSL17C-C2. Emergency output —7W for 90 minutes. Maximum mounting height: 23.3ft. (Black reflector color: 18.1ft.)

**Labels**

UL and cUL listed. Suitable for Dry or Damp Locations, indoor use only. Specify wet listed (WL) for recessed ceiling applications in indoor and outdoor locations. Lutron Drivers not recommended for outdoor environments below 0°C.

**Lumen Maintenance**

Reported: L70 at >63,000 hours  
Derived from EPA TM-21 calculator

**Warranty**

LED System rated for operation in ambient environments up to 25°C. 5 year limited warranty.

**TRIM & LED SPECIFICATIONS**

**LED System**

Proprietary array incorporates premium LEDs on a robust platform. May be specified in 2700K, 3000K, 3500K or 4000K, CRI>80. Color accuracy within 2 SDCM. Aluminum heat sink provides appropriate thermal management.

**Aesthetics**

Die-formed aluminum reflector ensures glare free optics. Reflector attaches to die-cast, seamless flange and may be removed for field painting. Torsion springs pull trim tight to the ceiling with no visible fasteners within the trim.

**Optics**

55-degree cut-off to light source and its image.

**PERFORMANCE CHART**

Delivered Lumens	System Watts	LPW
1000	13	76
1500	21	73
2000	26	78
2500	36	69
3000	45	67

\*Based on 3000/3500K. Clear Diffuse reflector cone. 80CRI Multipliers: 2700K: 0.94, 4000K: 0.1.06. 90CRI Multipliers: 2700K: 0.71, 3000/3500K: 0.83, 4000K: 0.89. Black Multiplier: 0.56. White Multiplier: 1.13. Lumen output may vary +/- 5%. Actual wattage may vary +/- 5%.

**HOUSING ORDERING**

<b>Housing Series</b>	FLC44D	<b>FLC44D</b>
ID+ 4.5" Square Downlight		
<b>Trim Type</b>		<b>SO</b>
Square Overlap	SO	
(Click to view trimless cutsheet)		
<b>Lumen Output</b>		
1000 Lumens	1000L	
1500 Lumens	1500L	
2000 Lumens	2000L	
2500 Lumens	2500L	
3000 Lumens	3000L	
<b>Voltage</b>		
120V	120	
277V**	277	
<b>Driver</b>		
0-10V - 1% Dimming	L11	
0-10V - 10% Dimming	LD1	
Lutron A-Series	L3D	
1% EcoSystem Digital		
(Consult factory for 3-wire control)		
DALI - 1% Dimming	D11	
<b>Housing Type</b>		<b>T</b>
Thermally Protected, Non-IC	T	
<b>Factory Options</b>		
Bar Hangers	BH	
Chicago Plenum / National Plenum	CP	
Emergency Battery	EM	
(Must order LC44EM trim)		
TechZone Brackets	TZB	

**TRIM & LED MODULE**

<b>Aperture</b>		
4.5" Square Reflector	LC44	
4.5" Square Reflector - Emergency	LC44EM	
(Required for "EM" option)		
<b>Trim Type</b>		<b>SQ</b>
Square	SQ	
<b>Lumen Output</b>		
1000 Lumens	1000L	
1500 Lumens	1500L	
2000 Lumens	2000L	
2500 Lumens	2500L	
3000 Lumens	3000L	
<b>Color Temperature</b>		
2700K	27K	
2700K, 90CRI	927K	
3000K	30K	
3000K, 90CRI	930K	
3500K	35K	
3500K, 90CRI	935K	
4000K	40K	
4000K, 90CRI	940K	
<b>Optic</b>		<b>DN</b>
Downlight	DN	
<b>Color</b>		
Clear Diffuse	CD	
Warm Diffuse	WD	
Black	BK	
White	WH	
<b>Flange Finish</b>		
Black	BK	
White	WH	
Titanium Silver	TS	
Aluminum Raw	AL	
<b>Factory Options</b>		
Wet Listed	WL	
(Not available with 90CRI)		

A complete unit consists of two line items, housing and trim  
Example: FLC44D-SO-1500L-120-LD1-T | LC44-SQ-1500L-35K-DN-CD-WH



\*For more information visit focalpointlights.com/reference or consult factory.

\*\*1500 and 2000 lumen outputs add 2 watts to system

Quickship is a limited offering, visit focalpointlights.co

# id+ 4.5" x 4.5"

LED DOWNLIGHT

## FLC44D-SO-1000L-120-L11-T / LC44-SO-1000L-35K/40K-DN-CD-NP

Filename: FLC44DSO1000L\_35K\_40K\_DNCD.IES  
Test #: 1100918

Lumens: 1004lm  
System Watts: 13W  
LPW: 77

### CANDLEPOWER DISTRIBUTION

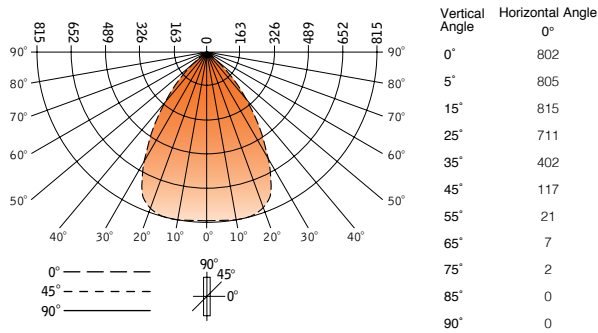

### LUMEN SUMMARY

Zone	Lumens	% Fixture
0-30°	628	62.5
0-40°	877	87.3
0-60°	994	99.0
0-90°	1004	100.0
<b>Total Luminaire</b>	<b>0-180°</b>	<b>1004</b>

### FOOTCANDLE VALUES

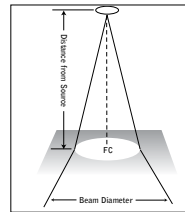

0° aiming angle - horizontal surface

Distance from source	Beam Diameter	Center Beam (FC)
4'	5.0'	50
6'	7.5'	22
8'	10.0'	13
10'	12.5'	8

Footcandle results based on AGI32; Reflectances=0/0/0; LLF=1

Go to [www.focalpointlights.com](http://www.focalpointlights.com) for additional photometric data.

# id+ 4.5" x 4.5"

LED DOWNLIGHT

## FLC44D-SO-1500L-120-L11-T / LC44-SO-1500L-35K/40K-DN-CD-NP

Filename: FLC44DSO1500L\_35K\_40K\_DNCD.IES  
Test #: 1100920

Lumens: 1545lm  
System Watts: 21W  
LPW: 74

### CANDLEPOWER DISTRIBUTION

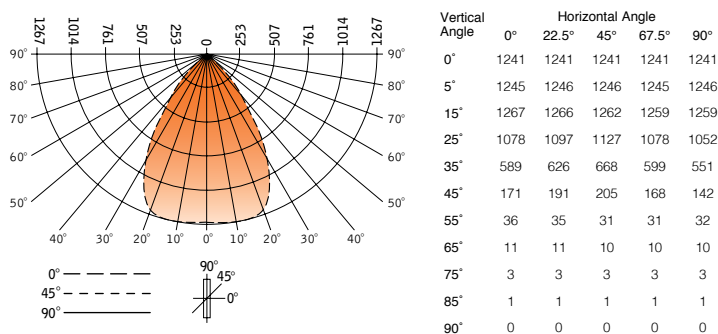

### LUMEN SUMMARY

Zone	Lumens	% Fixture
0-30°	968	62.7
0-40°	1350	87.4
0-60°	1530	99.0
0-90°	1545	100.0
<b>Total Luminaire</b>	<b>0-180°</b>	<b>1545</b>

### FOOTCANDLE VALUES

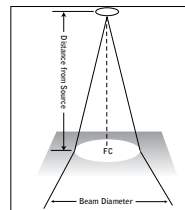

0° aiming angle - horizontal surface

Distance from source	Beam Diameter	Center Beam (FC)
4'	5.4'	78
6'	8.2'	34
8'	10.9'	19
10'	13.6'	12

Footcandle results based on AGI32; Reflectances=0/0/0; LLF=1

Go to [www.focalpointlights.com](http://www.focalpointlights.com) for additional photometric data.

# id+ 4.5" x 4.5"

LED DOWNLIGHT

## FLC44D-SO-2000L-120-L11-T / LC44-SO-2000L-35K/40K-DN-CD-NP

Filename: FLC44DSO2000L\_35K\_40K\_DNCD.IES  
Test #: 1117173

Lumens: 2078  
System Watts: 27W  
LPW: 77

### CANDLEPOWER DISTRIBUTION

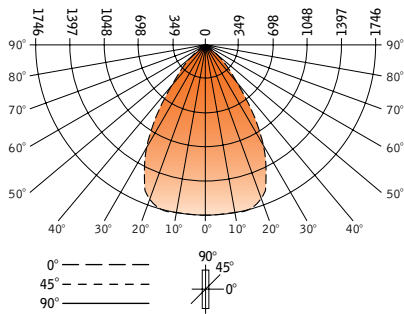

Vertical Angle	Horizontal Angle				
	0°	22.5°	45°	67.5°	90°
0°	1740	1740	1740	1740	1740
5°	1744	1741	1742	1742	1746
15°	1743	1733	1728	1730	1737
25°	1443	1466	1515	1456	1428
35°	775	823	880	803	745
45°	210	240	269	225	190
55°	46	44	40	42	44
65°	15	14	13	14	14
75°	4	4	4	4	4
85°	1	2	1	2	1
90°	0	0	0	0	0

### LUMEN SUMMARY

Zone	Lumens	% Fixture
0-30°	1318	63.4
0-40°	1824	87.8
0-60°	2058	99.0
0-90°	2078	100.0
<b>Total Luminaire 0-180°</b>	<b>2078</b>	<b>100.0</b>

### FOOTCANDLE VALUES

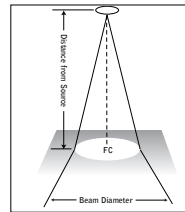

0° aiming angle - horizontal surface

Distance from source	Beam Diameter	Center Beam (FC)
4'	5.3'	109
6'	8.0'	48
8'	10.6'	27
10'	13.3'	17

Footcandle results based on AGI32; Reflectances=0/0/0; LLF=1

Go to [www.focalpointlights.com](http://www.focalpointlights.com) for additional photometric data.

# id+ 4.5" x 4.5"

LED DOWNLIGHT

## FLC44D-SO-2500L-120-L11-T / LC44-SO-2500L-35K/40K-DN-CD-NP

Filename: FLC44DSO2500L\_35K\_40K\_DNCD.IES  
Test #: 1117171

Lumens: 2617  
System Watts: 38W  
LPW: 69

### CANDLEPOWER DISTRIBUTION

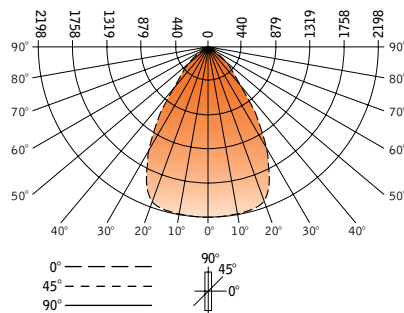

Vertical Angle	Horizontal Angle				
	0°	22.5°	45°	67.5°	90°
0°	2191	2191	2191	2191	2191
5°	2198	2193	2194	2194	2198
15°	2197	2184	2176	2179	2188
25°	1822	1848	1908	1835	1798
35°	981	1036	1104	1011	937
45°	262	302	337	283	238
55°	58	56	50	53	55
65°	18	18	17	18	18
75°	5	5	6	5	5
85°	1	2	1	2	1
90°	0	0	0	0	0

### LUMEN SUMMARY

Zone	Lumens	% Fixture
0-30°	1660	63.4
0-40°	2297	87.8
0-60°	2591	99.0
0-90°	2617	100.0
<b>Total Luminaire 0-180°</b>	<b>2617</b>	<b>100.0</b>

### FOOTCANDLE VALUES

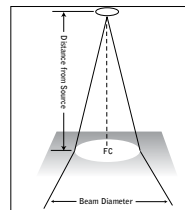

0° aiming angle - horizontal surface

Distance from source	Beam Diameter	Center Beam (FC)
4'	5.4'	137
6'	8.2'	61
8'	10.9'	34
10'	13.6'	22

Footcandle results based on AGI32; Reflectances=0/0/0; LLF=1

Go to [www.focalpointlights.com](http://www.focalpointlights.com) for additional photometric data.

# id+ 4.5" x 4.5"

LED DOWNLIGHT

## FLC44D-SO-3000L-120-L11-T / LC44-SO-3000L-35K/40K-DN-CD-NP

Filename: FLC44DSO3000L\_35K\_40K\_DNCD.IES  
Test #: 1117172

Lumens: 3014  
System Watts: 45W  
LPW: 67

### CANDLEPOWER DISTRIBUTION

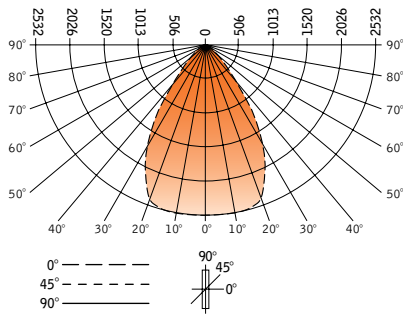

Vertical Angle	Horizontal Angle				
	0°	22.5°	45°	67.5°	90°
0°	2523	2523	2523	2523	2523
5°	2528	2526	2527	2527	2532
15°	2527	2516	2506	2510	2519
25°	2097	2127	2198	2115	2072
35°	1127	1189	1269	1166	1082
45°	301	346	389	327	275
55°	66	65	58	61	63
65°	21	21	19	20	21
75°	6	6	6	6	6
85°	1	2	1	3	2
90°	0	0	0	0	0

### LUMEN SUMMARY

Zone	Lumens	% Fixture
0-30°	1912	63.4
0-40°	2645	87.7
0-60°	2984	99.0
0-90°	3014	100.0
<b>Total Luminaire 0-180°</b>	<b>3014</b>	<b>100.0</b>

### FOOTCANDLE VALUES

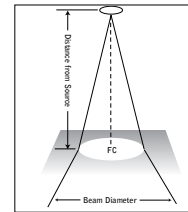

0° aiming angle - horizontal surface

Distance from source	Beam Diameter	Center Beam (FC)
4'	5.4'	158
6'	8.2'	70
8'	10.9'	39
10'	13.6'	25

Footcandle results based on AGI32; Reflectances=0/0/0; LLF=1

Go to [www.focalpointlights.com](http://www.focalpointlights.com) for additional photometric data.





# Covert®

LED

RL

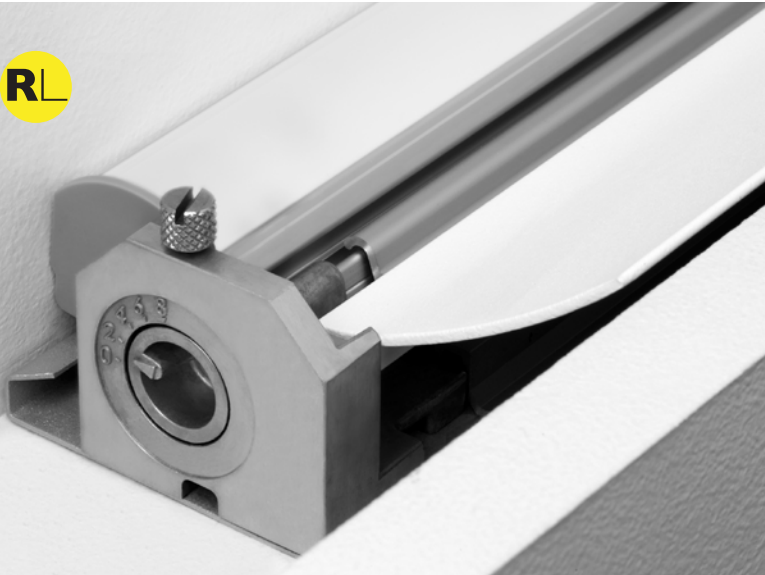

## DIMENSIONAL DATA

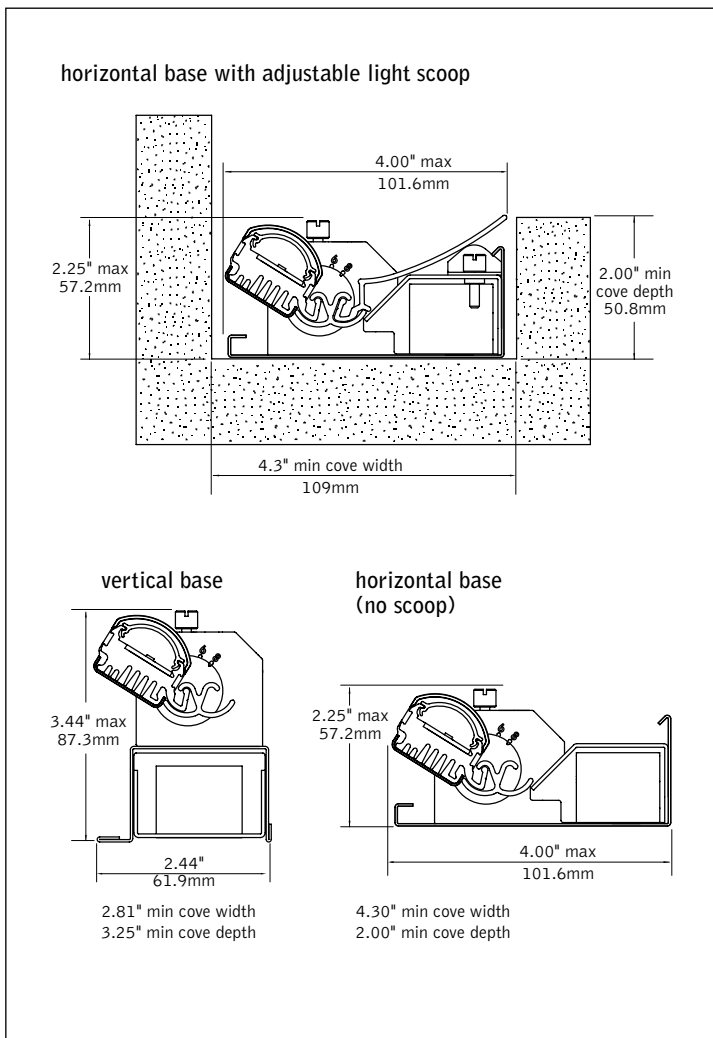

## FEATURES

Small profile indirect LED luminaire designed for concealed cove applications.

Adjustable Light Bar and Light Scoop aim to optimize distribution in any cove application.

Luminaires are provided with quick connect thru-wire harness for ease of installation in continuous runs.

Continuous runs may be specified in 1' increments.

Covert™ provides pleasing and shadow-free illumination that highlights architectural details.

## PERFORMANCE

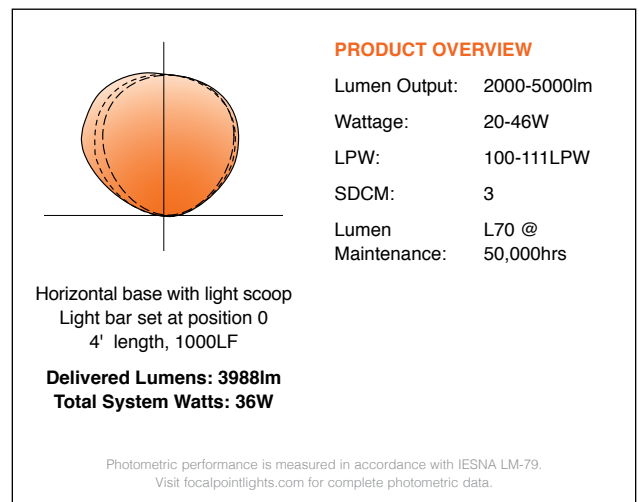

**DETAILS**

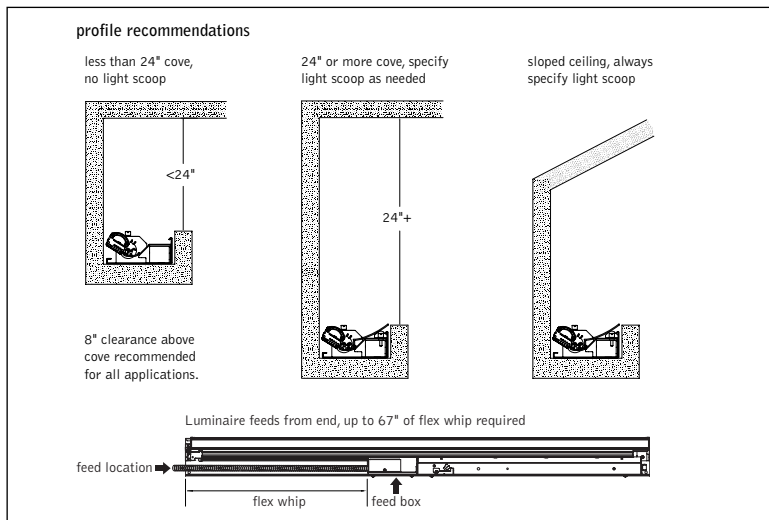

**SPECIFICATIONS**

**LED System**

Proprietary linear LED module incorporates premium LEDs on a robust platform to achieve excellent thermal management. LEDs are placed to promote a uniform appearance. Available in 3000K, 3500K or 4000K with CRI>80, 3SDCM. 0-10V dimming driver standard. LED modules and drivers are replaceable.

**Construction**

.07" thick extruded aluminum LED module housing. 20 Ga. steel driver compartment and outer housing. Optional adjustable light scoop of .07" thick extruded aluminum. 4' unit weight: 9.5lbs

**Optic**

Continuous illumination enabled by linear LED modules shielded by extruded acrylic lens. Light Bar and Light Scoop adjust and lock to aim peak candela and/or shape overall distribution.

**Electrical**

Standard 120-277V driver includes 0-10V analog dimming. Dimming range 100% - 10%. Power factor > .9. Optional EcoSystem dimming drivers from Lutron available.

**Labels**

ETL listed in accordance with UL standards. Suitable for Dry or Damp Locations, indoor use only.

**Lumen Maintenance**

L70 at 50,000 hours.

**Warranty**

LED system rated for operation in ambient environments up to 25°C. 5 year limited warranty.

**4' PERFORMANCE CHART**

Profile	Lumens per Foot	Light Bar Adjustment Settings	Delivered Lumens	Total System Watts	Peak Candela
HS	500LF	0*	2000	20	675@165°
	750LF	0*	3000	28	1012@165°
	1000LF	0*	3988	36	1352@165°
	1250LF	0*	5000	46	1687@165°

\*light scoop in fully open position.

**ORDERING**

Luminaire Series	FCOL	FCOL
Covert - Adjustable LED Cove Light	FCOL	_____
<b>Profile</b>		
Horizontal base	HN	_____
Horizontal base wth light scoop	HS	_____
Vertical base	VN	_____
<b>LED System</b>		
500 Lumens per foot	500LF	_____
750 Lumens per foot	750LF	_____
1000 Lumens per foot	1000LF	_____
1250 Lumens per foot	1250LF	_____
<small>(not available with L3D Driver)</small>		
<b>Color Temperature</b>		
3000K	30K	_____
3500K	35K	_____
4000K	40K	_____
<b>Circuits</b>		
Single Circuit	1C	_____
<b>Voltage</b>		
120 Volt	120	_____
277 Volt	277	_____
UNV	UNV	_____
<b>Driver</b>		
0-10V - 10% Dimming	LD1	_____
Lutron A-Series	L3D	_____
1% EcoSystem Digital		_____
<small>(Not available with 1250 lumens per foot. Consult factory for 3-wire dimming)</small>		
<b>Mounting</b>		
Cove	CV	_____
<b>Nominal Luminaire Length</b>		
Specify in 1' increments	XX	_____

(Consult factory for limitations regarding 2' units, corners, patterns & curved cove applications. Multiple feeds may be required beyond 64'. Consult factory for specifics.)

# Covert™

LED HORIZONTAL BASE WITH LIGHT SCOOP

**FCOL-HS-1000LF-L30-1C-120-LD1-CV-4'**

Filename: FCOLHS1000LF35K.IES  
Test #: 18259.0

Lumens: 3998lm  
System Watts: 36W  
LPW: 111

## CANDLEPOWER DISTRIBUTION

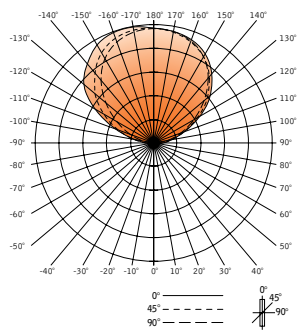

Vertical Angle	Horizontal Angle										Zonal Lumens
	0°	22.5°	45°	67.5°	90°	112.5°	135°	157.5°	180°		
0°	0	0	0	0	0	0	0	0	0	0	0
5°	0	0	0	0	0	0	0	0	0	0	0
15°	0	0	0	0	0	0	0	0	0	0	0
25°	2	1	0	0	0	0	0	0	0	0	0
35°	6	6	4	0	0	0	0	0	0	0	1
45°	10	9	6	0	0	0	0	0	0	0	2
55°	16	12	7	1	0	0	0	0	0	0	3
65°	18	13	9	1	0	0	0	0	0	0	4
75°	40	3	13	1	0	0	0	0	0	0	9
85°	72	68	48	16	0	0	0	0	0	0	23
90°	101	101	74	40	3	2	0	0	0	0	2
95°	148	145	120	82	38	97	102	32	123	97	
105°	249	270	258	220	186	265	329	285	347	275	
115°	438	468	450	423	405	484	554	548	624	477	
125°	704	709	678	645	617	690	784	823	938	643	
135°	921	914	879	846	836	904	963	1038	1128	717	
145°	1091	1072	1048	1042	1046	1091	1129	1179	1244	689	
155°	1209	1199	1186	1168	1184	1207	1243	1271	1328	561	
165°	1274	1275	1265	1252	1268	1289	1300	1312	1352	363	
175°	1301	1301	1295	1295	1301	1314	1316	1309	1329	125	
180°	1310	1310	1310	1310	1310	1310	1310	1310	1310		

## LUMEN SUMMARY

Zone	Lumens	% Fixture
0°-30°	0	0
0°-90°	41	1.0
90°-130°	1492	37.4
90°-180°	3946	99.0
<b>Total Luminaire</b>	<b>3998</b>	<b>100.0</b>

Go to [www.focalpointlights.com](http://www.focalpointlights.com) for additional photometric data.



**DIMENSIONAL DATA**

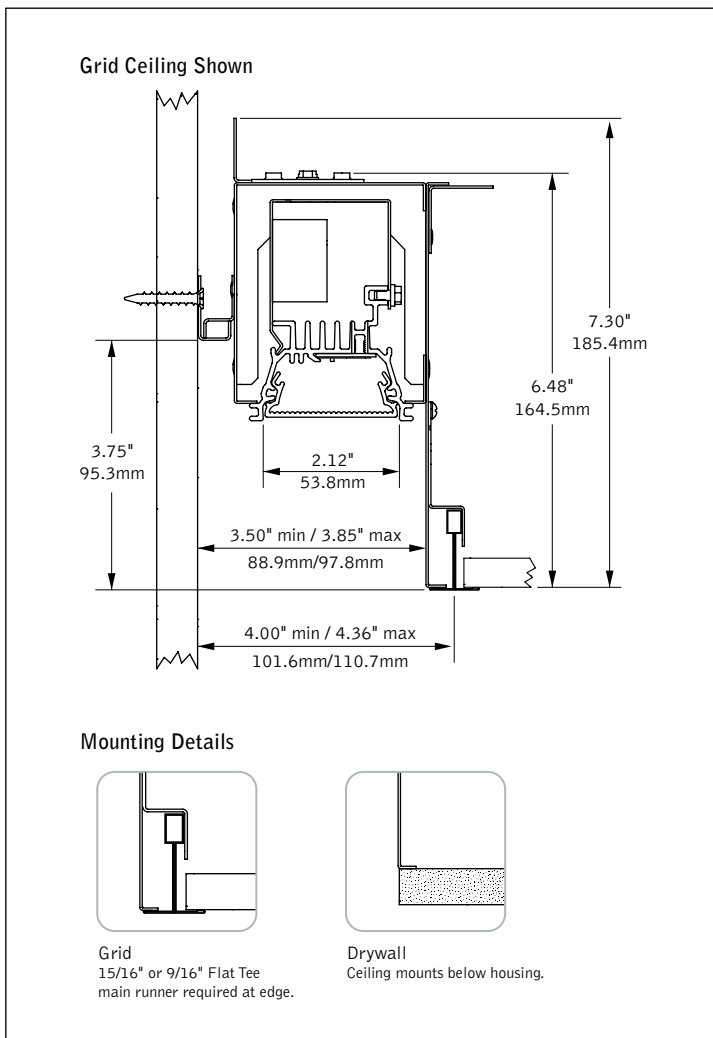

**FEATURES**

- Low wattage LED slot provides glowing transition between wall and ceiling.
- Frosted lens with linear micro prism pattern obscures visibility to LED's and provides continuous, shadow-free illumination.
- Housing creates 3" architectural slot.
- Premium LEDs operate efficiently on a solid-core module platform to achieve excellent thermal management and reliable operation.
- L70 at 50,000 hours

**PERFORMANCE**

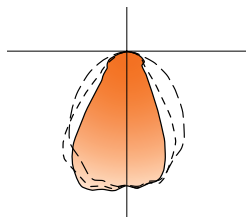

**PRODUCT OVERVIEW**

Lumen Output:	1207lm
Wattage:	23W per 4'
LPW:	53
SDCM:	3
Lumen Maintenance:	L70 @ 50,000hrs

**4' Luminaire**

**Delivered Lumens: 1207lm**

**Total System Watts: 22.9W**

Photometric performance is measured in accordance with IESNA LM-79. Visit focalpointlights.com for complete photometric data.

**DETAILS**

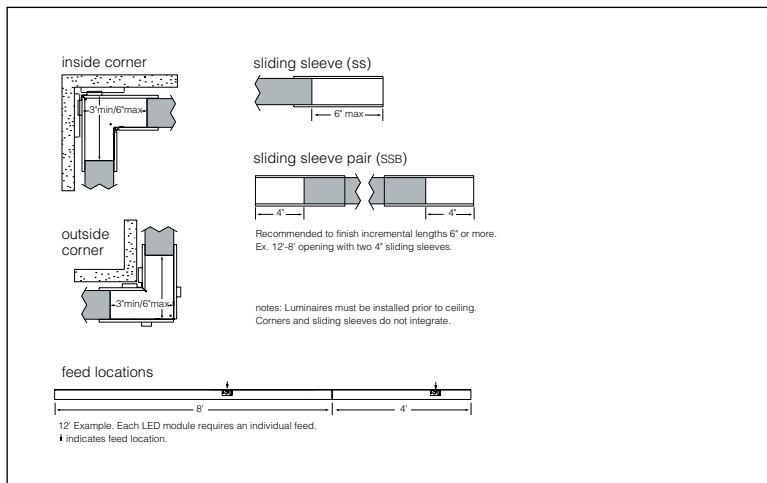

**SPECIFICATIONS**

**LED System**

Proprietary linear LED module incorporates premium LEDs on a solid-core platform to achieve excellent thermal management. Module is available in 3000K, 3500K or 4000K with CRI > 80. 0-10V dimming driver standard. LED module and driver are replaceable from below.

**Construction**

One piece .07" thick LED module housing of extruded aluminum. 20 Ga. steel outer housing creates floating ceiling effect and adjusts for alignment with walls. 20 Ga. steel internal bulkheads. 20 Ga. steel sliding sleeves and corners. 4' unit weight: 26 lbs.

**Optic**

Continuous illumination enabled by linear LED modules shielded by ribbed extruded frosted acrylic lens .06" thick with opal satin finish. Extended outer housing provides cutoff to illuminated lens.

**Electrical**

Standard 120-277V driver includes 0-10V analog dimming. Power factor > .9.

**Labels**

UL and cUL listed. Suitable for Dry or Damp Locations, indoor use only. Suitable for wood ceiling applications.

**Finish**

Polyester powder coat applied over a 5-stage pre-treatment.

**Lumen Maintenance**

L70 at 50,000 hours.

**Warranty**

LED system rated for operation in ambient environments up to 25°C. 5 year limited warranty.

**ORDERING**

<b>Luminaire Series</b>		<b>FTRL</b>
Trace	FTRL	_____
<b>Shielding</b>		<b>AC</b>
Frosted Acrylic Diffuser	AC	_____
<b>LED System</b>		<b>LL1</b>
Standard Output	LL1	_____
<b>Color Temperature</b>		_____
3000K	30K	_____
3500K	35K	_____
4000K	40K	_____
<b>Circuits</b>		<b>1C</b>
Single Circuit	1C	_____
<b>Voltage</b>		_____
120 Volt	120	_____
277 Volt	277	_____
UNV	UNV	_____
<b>Driver</b>		<b>LD1</b>
0-10V - 10% Dimming	LD1	_____
<b>Mounting</b>		_____
Grid	G	_____
Drywall	XF	_____
<b>Factory Options</b>		_____
Chicago Plenum	CP	_____
Emergency Circuit*	EC	_____
Flanged Ends	FL	_____
<small>(Recommended for applications where luminaire does not terminate at a wall or with Sliding Sleeve)</small>		
HLR/GLR Fuse	FU	_____
Sliding Sleeve	SS	_____
Sliding Sleeve Pair	SSB	_____
<small>(3' minimum length)</small>		
<b>Finish</b>		<b>WH</b>
Matte White Housing	WH	_____
<b>Luminaire Length</b>		_____
Specify luminaire/row length in 1' increments	XX'	_____
<small>(2' minimum)</small>		
<b>Corner Options</b>		_____
90-degree Inside Corner	FTRL-IC90	_____
90-degree Outside Corner	FTRL-OC90	_____

# FINELITE

## High Performance 2" Aperture (HP-2) - Recessed



Date

Project

Type

Comments



### DESCRIPTION

High Performance 2" Aperture Recessed (HP-2 R) is a patented linear LED luminaire for offices, schools, retail and healthcare facilities. The micro shape delivers excellent performance in a 2" aperture by using advanced optical design and mid-power LEDs. This long-life luminaire is free of socket shadows and can be specified for rows or configurations.

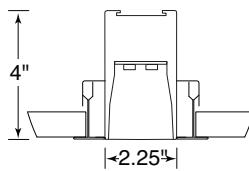

### DIMENSIONS & LIGHT ENGINE:

A glare-free experience is attained with mid-powered LEDs properly distributed and paired with a precise diffuser to eliminate pixilation. Aperture: 2.25"\*

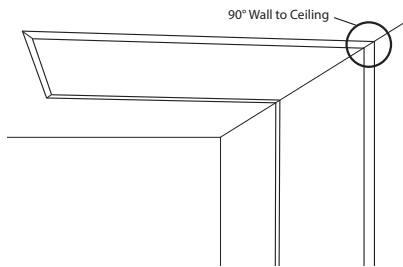

### MITERED ANGLES:

Illuminated 90° corners and wall-to-ceiling configuration are seamless without socket shadows. Custom angles are available (90° minimum on inside corners). Contact factory.

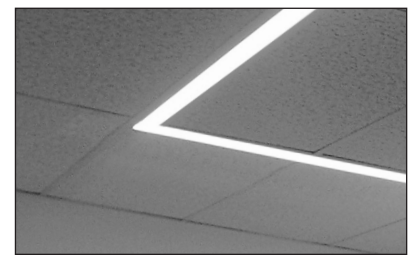

### SEAMLESS ILLUMINATION:

The optical design features seamless lenses up to 12' in length and eliminates socket shadows at joints and corners.

### ORDERING GUIDE

Sample Number: HP-2 R - 32' - H0 - 3500K - 120V - SC - C1 - OBO

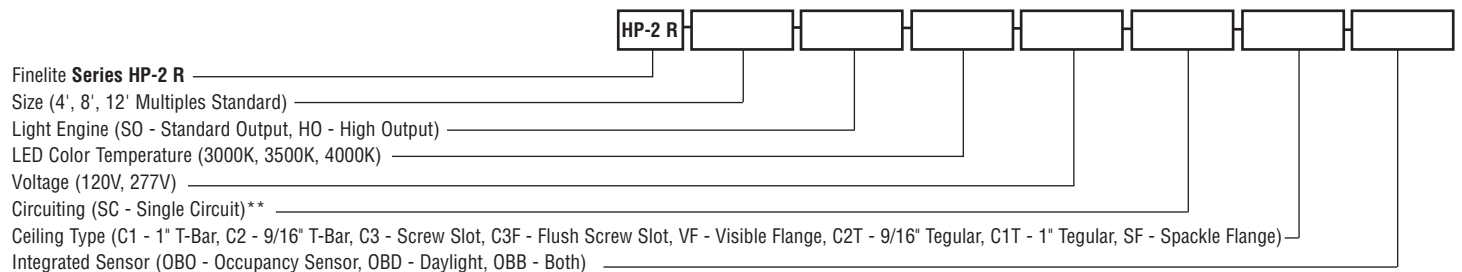

\*See page 3 for cutout dimensions.  
\*\* Contact factory for switching options.

Protected by one or more US Patents: 8915613; D702,391; D702,390; D700,732

Finelite, Inc. • 30500 Whipple Road • Union City, CA 94587-1530 • 510 / 441-1100 • Fax: 510 / 441-1510 • www.finelite.com

Due to continuing product improvements, Finelite reserves the right to change specifications without notice. Please visit www.finelite.com for most current data.

# FINELITE

## High Performance 2" Aperture (HP-2) - Recessed

### PHOTOMETRY

Standard Output  
Efficacy: 62 lumen per watt  
Total luminaire output: 1148 lumens (287 lumens/foot)  
18.5 watts (4.6 watts/foot)  
Peak Candela Value: 420 @ 0°  
CCT: 3500K  
Source Report 81641  
(Family Correlation)

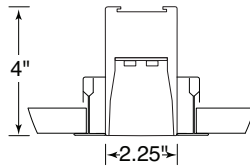

High Output  
Efficacy: 56.9 lumen per watt  
Total luminaire output: 2083 lumens (521 lumens/foot)  
36.6 watts (9.1 watts/foot)  
Peak Candela Value: 763 @ 0°  
CCT: 3500K  
ITL LM79 Report 81641

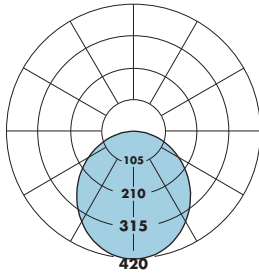
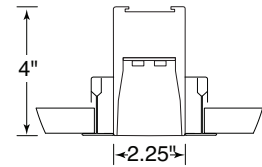

CANDLEPOWER SUMMARY						
	0.0	22.5	45	67.5	90	Flux
0	420	420	420	420	420	
5	418	417	417	417	417	40
15	401	398	400	400	398	113
25	366	362	364	363	362	167
35	319	315	316	314	314	197
45	263	261	261	259	258	201
55	203	201	201	199	198	179
65	141	139	139	138	138	138
75	82	80	80	79	79	85
85	26	26	26	26	25	28
90	0	0	0	0	0	

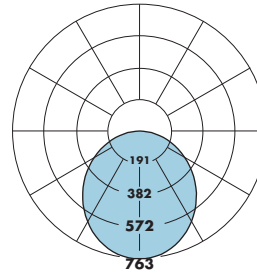

CANDLEPOWER SUMMARY						
	0.0	22.5	45	67.5	90	Flux
0	763	763	763	763	763	
5	760	757	757	758	756	72
15	727	723	726	725	723	204
25	664	657	661	658	656	303
35	578	572	574	570	569	358
45	478	473	473	470	469	364
55	368	365	364	361	360	325
65	256	253	253	251	251	250
75	148	146	145	144	144	154
85	48	47	47	47	46	51
90	0	0	0	0	0	

### SPECIFICATIONS

**CONSTRUCTION:** Precision cut 6061-T6 extruded aluminum body. Internal joiner system, plug-together wiring standard. Housing is powder coated.

**ENDCAPS:** Flat endcap at each end of run adds 0.1" to overall length.

**REFLECTORS:** Die-formed 24-gauge cold-rolled steel reflectors are finished in 96 LG high reflectance matte white powder coat paint.

**DOWNLIGHT DIFFUSER:** Frost white snap-in lens, 73% transmissive, 99% diffusion.

**LIGHT ENGINE:** Available in two lumen packages- High output and Standard Output. High Output (HO) 3000K delivers 499 lumens per foot (36.6W per 4' luminaire)\*. Standard Output (SO) 3000K delivers 275 lumens per foot (18.5W per 4' luminaire)\*. High Output (HO) 3500K delivers 521 lumens per foot (36.6W per 4' luminaire). Standard Output (SO) 3500K delivers 287 lumens per foot (18.5W per 4' luminaire)\*. High Output (HO) 4000K delivers 541 lumens per foot (36.6W per 4' luminaire)\*. Standard Output (SO) 4000K delivers 297 lumens per foot (18.5W per 4' luminaire)\*.

**LED COLOR TEMPERATURE:** Available in 3000K, 3500K, and 4000K.

**DRIVER:** High performance Constant Current Reduction (CCR) driver standard. 120V/277V. Can be wired as dimming or non-dimming. Dimming is compatible with 0-10V controls with a range of 10%-100%. Driver is fully accessible from below the ceiling. Power Factor: ≥0.9. Total Harmonic Distortion (THD) <20%. Expected driver lifetime: 100,000 hours. Lutron driver options: Lut3W- 3-wire driver, LutES - EcoSystem driver, Lut2W - 2-wire driver.

**ELECTRICAL:** 120V or 277V prewired. Emergency to generator/inverter wiring, internal generator transfer switch, nightlight wiring, battery backup. Low profile battery backup available. Battery backup delivers 1000 lumens. Minimum fixture length for battery Pack: 8'. Half of the luminaire will be illuminated in the 4' section controlled.

**INTEGRATED SENSORS:** HP-2 R can be specified with integrated PIR (Passive Infrared) occupancy sensors or daylight sensors. Refer to Occupancy Sensor and Daylight Sensor tech sheets for more info.

**MOUNTING:** Standard bracket design works with most layout-in ceiling types. Brackets secure luminaire to ceiling grid from above. Tie-in T-Bar brackets. Connect luminaire to T-Bar for securing to structure. Consult local code for appropriate tie-wire recommendations.

**FEED:** Standard with (5) 18 gauge wires. 14 gauge wires used when fixture current exceeds 5 amps. Optional 6' flex conduit whips available.

**LENGTHS:** 4', 8', and 12' section lengths can be combined to make longer runs. Contact factory for lengths in increments of 1' or down to the 1/16 inch.

**LABELS:** Label: Fixture and electrical components are ETL listed conforming to UL 1598 in the U.S.A., and Canada; ETL listed to certified CAN/CSA C22.2 No. 250.0. In accordance with NEC Code 410.73 (G), this luminaire contains an internal driver disconnect. Damp location.

**WEIGHT:** Fixture weight = 2.3 lb/ft.

**WARRANTY:** HP-2 R comes standard with a 10-year warranty on all standard components. Optional accessories are covered by their individual manufacturer warranties.

	Lumen Output Per Foot					
	3000K		3500K		4000K	
	SO*	HO*	SO*	HO	SO*	HO*
<b>Total Lumens Per Foot</b>	275	499	287	521	297	541
<b>Total Watts Per Foot</b>	4.6	9.2	4.6	9.2	4.6	9.2
<b>Efficacy (LPW)</b>	59.5	54.5	62.1	56.9	64.2	59.1

SO - Standard Output, HO - High Output

\* Family Correlation

Protected by one or more US Patents: 8915613; D702,391; D702,390; D700,732

Finelite, Inc. • 30500 Whipple Road • Union City, CA 94587-1530 • 510 / 441-1100 • Fax: 510 / 441-1510 • www.finelite.com

Due to continuing product improvements, Finelite reserves the right to change specifications without notice. Please visit www.finelite.com for most current data.



# FINELITE

## High Performance 2" Aperture (HP-2) - Recessed

### MOUNTING TYPES: T-Bar

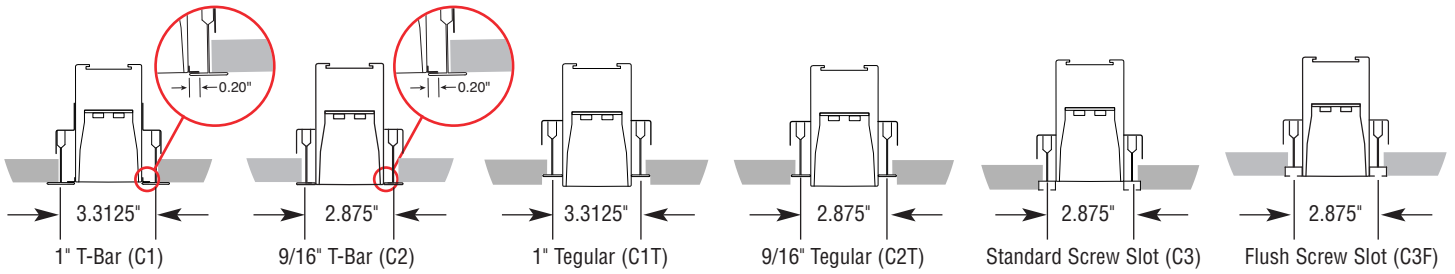

### MOUNTING TYPES: CUTOUT DIMENSIONS

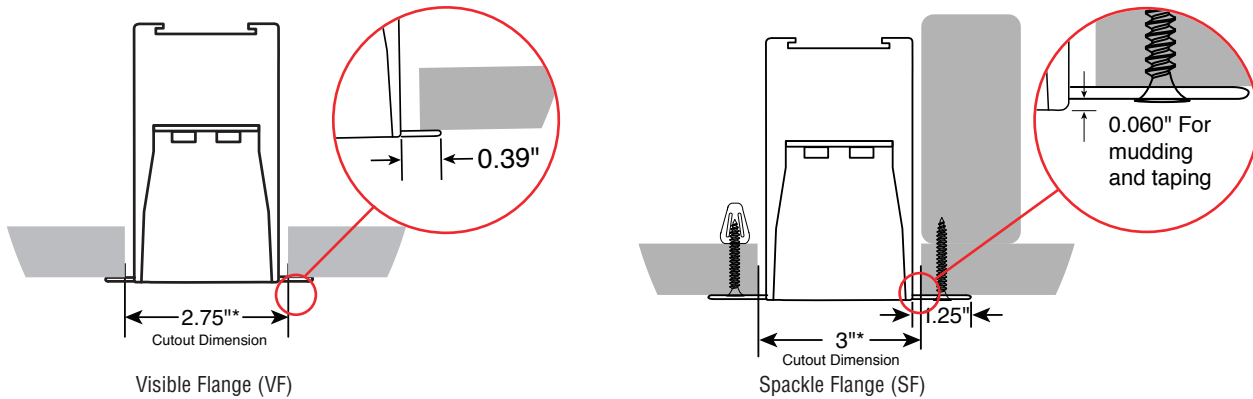

\* Note: +/- 1/16"

Protected by one or more US Patents: 8915613; D702,391; D702,390; D700,732

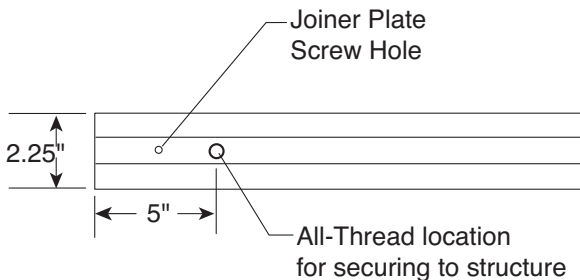

#### SHEET ROCK INSTALLATION:

Flex conduit is secured at the end cap. Support to structure using All-Thread. All-Thread support holes are located on each end of the fixture.

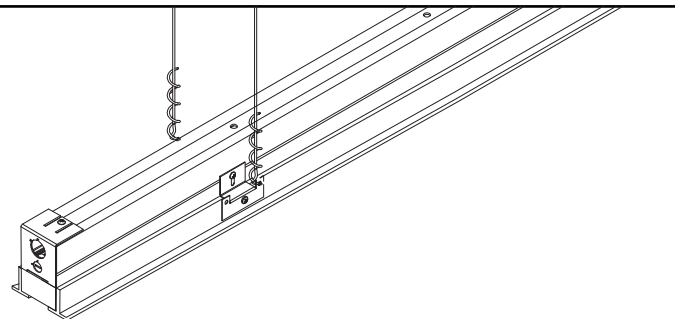

#### T-BAR INSTALLATION:

HP-2 R for T-Bar installations comes standard with a splice plate at the end of the luminaire. Mounting brackets (supplied) secure the fixture to T-Bar and provide support to structure location. All starter/independent fixtures are 11/8" shorter than nominal. All joiner/ender fixtures are normal length.



## Novo I - Dimmable LED Strip 250 lm/ft Package

### Details

- 120V input
- 120 degree beam angle
- 250lm/ft package indoor non-bendable LED strips are available in 8" / 12" / 18" / 24" / 32" lengths
- Dimmable with most standard incandescent dimmers
- Modular design for maximum flexibility and quick installation
- Allows up to 400W maximum power to be connected at once using the optional internal straight connector end-to-end or jumper cords
- Features 2 adjustable mounting clips (0-90 degree)
- Mounting clips(P/N: 555MC) and end-to-end connector(P/N: 55500) are included with each strip
- External occupancy sensor available as an option
- 50,000 hour lifetime, 5 year warranty
- Energy Star rated
- Go to Novo Accessories for other options. (Must order Power Cord or J-box)
- Warranty Information: See our Terms and Conditions for further details

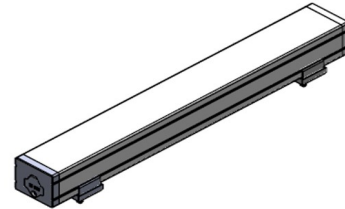
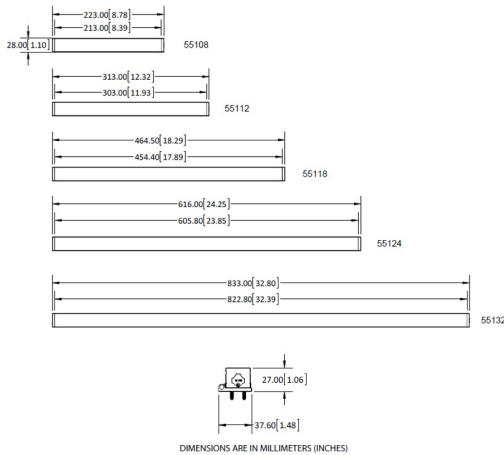
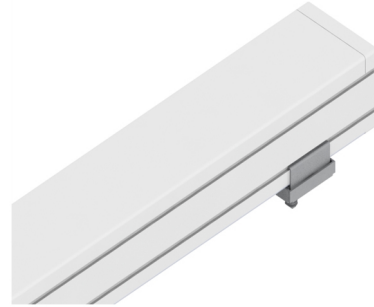

**Catalog No. \***

(55132) Novo I - 32" Dimmable LED Strip - 10.8W

**Hardware Finish \***

(WH) White

**Lamp Type \***

(30K) LED 3000K Warm White Module Included

Order is incomplete. Refer to description.

## Important Technical Information

.....

It is suggested to use a dedicated circuit for Prima's low voltage systems and LED related products especially under the remodel applications. Do not mix circuits with any fluorescent lighting systems with low power factor ballast. The harmonic distortion may create heat and damage the secondary side of the transformers, drivers, and low voltage fixtures.

It is also important to control Prima lighting systems from individual dedicated switches or suitable dimmers. Do not toggle the power from the breakers in the main electrical panel. This is to ensure a safe environment for system maintenance and longevity reason.

It is also not recommended to use any of our low voltage system or individual fixtures including LED related products with occupancy sensor or any motion sensor related device.

Low voltage lighting systems produce level of high heat during the normal operations. Therefore, always turn the power off prior to performing any re-lamping, cleaning, or maintenance related work. Prima Lighting is not responsible for any damage or personal harm caused by irresponsible or improper handling of low voltage lighting systems.

Products that have been used improperly and not according to our instructions will not be replaced and all warranties will be void. Prima Lighting always includes lamps for each fixture we ship. The lamps we include are top quality and well-known name brands. We will normally send up to 50W halogen MR16, 7W LED MR16 for spotlights and 35W Xelogen G6.35 lamp for pendants, unless otherwise specified differently in the catalog.

Furthermore, most of our halogen or Xelogen lamps are rated at 10,000 hours lamp life. Prima will also ship according to customer's specific lamp type or wattage per order. Lamps are complimentary, thus we will not offer free replacement, nor will we issue any credit for lamps. However, customers may purchase lamps from us and receive standard lamp warranty. We always encourage our customers to purchase replacement lamps directly from us when replacements are needed.

We recommend the use of our transformers or LED drivers with our lighting systems, as they have been tested to work with our products. If systems are ordered without our transformers, all warranties are void and complimentary lamps will not be supplied.

Due to the nature of the manufacturing process of blown glass, no two glass pieces are exactly alike. Each piece of hand blown glass has its own unique characteristics that make it an individual work of art. Prima cannot guarantee the exact same color or texture between multiple pieces of the same type of glass.

If a low voltage lamp fails at any time, it should be replaced immediately to prevent further damage to other lamps in the system by excessive voltage. For applications which is using any of Prima low voltage halogen or Xelogen fixtures for more than 10-12 hours per day, customer must use a proper low voltage dimmer to slightly reduce the input voltage. This will help to extend not only the overall lamp life but also the system longevity. The interchangeable fixtures in our catalog and website are for decorative, accent, and task illumination purposes. These products are not ideal for general illumination purpose.

Any damages caused by the long hours running without a proper dimming system in place, Prima will reserve the right to warrant the products. In the event of light bulb 'flickering', system outage or bad electrical contact issues, always refer to the Prima Installation guide that was included with the original system shipment.

This guide will have troubleshooting steps that you may take to rectify the problem in most cases. If the system becomes non-operational, do not try to tap it with objects for fixing it. These sorts of actions will likely make the condition of a non-operational system even worse. The most important thing to do is test the voltage and temperature 30 to 60 minutes after the installation, this step is MANDATORY. Fail to provide such step may result in void of warranty. The ideal range at any of Prima 12V low voltage system power feed should be at 11.3 ~ 11.7 volts and 80 ~ 95 degrees Fahrenheit. Always follow Prima instruction sheets for detailed troubleshooting procedures. Please consult Prima Customer Service for troubleshooting either before or after installation.

LEDs are semiconductors with a very long lifespan. However, after approximately 75,000-100,000 hours of use at the ambient temperature, the brightness may lessen due to the silicon part where the light passes through eventually darkens. In addition, the lens may turn yellow after time and could also change the shade of the light. The reflector may also oxidize and reduce the reflection. With regular thermal cycles of turning the power on and off, the practical lamp life is 50,000 hours. LED fixtures must be wired correctly according to Prima instructions or you may risk causing irreparable damage to the transformer or LED driver. We recommend the use of our LED drivers and transformers with our light systems as they have been tested to work with our products. Avoid installing LED lights in areas of high heat as it may lessen the life of the lamp. Proper ventilation is very important to the LED fixtures. Be advised that the brightness of the light is not only determined by wattage but also is a combination of the lumens and the wattage of which the value shows the emitted light. Our products are ROHS compliant and have passed all tests prior to shipment. All product information including specifications is current as per the print date. We will try our best to update website information whenever there is changes, however, we reserves the right to change the details of specification, dimensions, color, and finishes without prior notice.



# FINELITE

## E1-Indirect Configuration Technical Sheet



Date

Project

Type

Comments

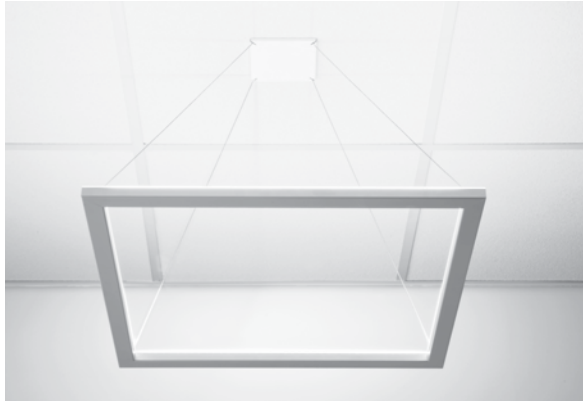

### DESCRIPTION

Patent Pending

Openness and clean lines define the aesthetic of E1-I. E1-I uses mid-power LEDs and a high performance optical design to spread light evenly, yielding a comfortable and energy efficient design. E1-I uses 0-10V dimmable drivers, is easily serviceable and available in an array of configurations to meet the specific needs of the designer.

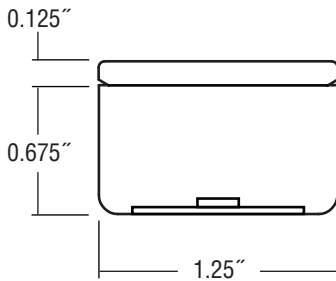

### DIMENSIONS/LIGHT ENGINE:

E1-I uses mid-power LEDs evenly distributed and paired with a precise diffuser to eliminate pixilation from viewable angles. Overall Dimensions: 0.80"H x 1.25"W.



### CONDUCTIVE CABLE:

Thin conductive cables bring power to and suspend E1-I, yielding a luminaire that appears to float in the space.

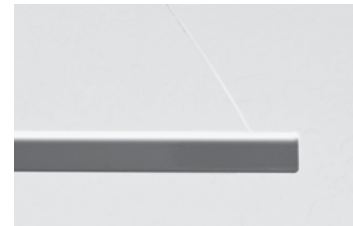

### TOP GLOW™ DIFFUSER:

The diffuser provides a uniform glow above the luminaire for a clean architectural element.

### ORDERING GUIDE

Sample Number: E1-I - C - 1'x1' - S - 8 - 35 - 277V - SC - C1

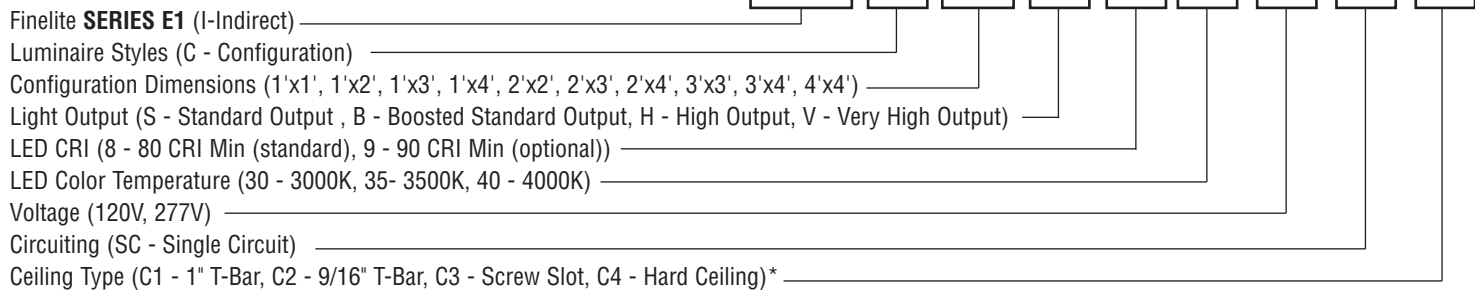

\* See page 3 for mounting information.



# FINELITE

## E1-Indirect Configuration Technical Sheet

### PHOTOMETRY

Very High Output - 2'x2'  
 Efficacy (lumens per watt): 124.5  
 Total luminaire output: 4642 lumens / 37.3 watts  
 CCT: 3500K; CRI: 80  
 ITL LM79 Report 85175

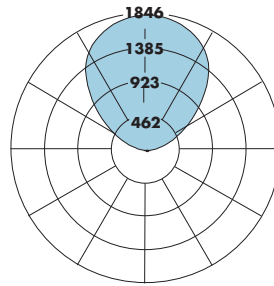

CANDLEPOWER SUMMARY						
	0	22.5	45.0	67.5	90.0	Flux
0	0	0	0	0	0	
5	2	2	2	1	1	0
15	7	7	8	7	6	2
25	10	11	12	13	10	5
35	12	14	17	17	13	10
45	13	17	21	19	15	14
55	13	18	22	19	15	16
65	13	19	22	19	15	18
75	13	19	22	19	15	20
85	16	20	23	21	17	21
90	14	16	17	15	11	
95	62	65	62	63	59	71
105	212	191	169	190	211	204
115	434	400	360	409	444	403
125	734	720	706	737	750	652
135	1108	1120	1152	1119	1102	864
145	1460	1459	1459	1454	1452	908
155	1658	1649	1651	1648	1655	761
165	1780	1770	1769	1767	1775	500
175	1836	1835	1835	1835	1835	174
180	1846	1846	1846	1846	1846	

Total Light Output, 3500K, 80 CRI (Lumens) - 2' x 2'			
S*	B*	H*	V**
1900	2389	3610	4642

Total Power, 3500K (Watts)			
S*	B*	H*	V**
14.6	18.6	28.6	37.3

Efficacy, 3500K, 80 CRI (Lumens Per Watt)			
S*	B*	H*	V**
129.9	128.6	126.4	124.5

S - Standard Output, B - Boosted Standard Output, H - High Output, V - Very High Output

\* Family Correlation based on 4' luminaire 3500K Very High Output (V) test - 120V.

\*\* Correlation based on ITL report: 85175

Lumen Adjustment Factors - 80 CRI	
3000K	0.985
3500K	1.000
4000K	1.032

Lumen Adjustment Factors - 90 CRI	
3000K	0.746
3500K	0.760
4000K	0.789

Apply a lumen adjustment factor to calculate lumens for the desired CCT and CRI.

### SAMPLE LUMEN ADJUSTMENT CALCULATION

Standard Output (S), 4000K, 90 CRI

$$\text{Lumen Adjustment Factor} = 0.789$$

$$\begin{aligned} \text{Total Light Output} &= \\ 1900 \text{ lm} \times 0.789 &= 1499 \text{ lm} \end{aligned}$$

$$\text{Efficacy} = \frac{1499 \frac{\text{lm}}{\text{ft}}}{14.6 \frac{\text{W}}{\text{ft}}} = 102.7 \text{ lm/W}$$

# FINELITE

## E1-Indirect Configuration Technical Sheet

### EASY INSTALLATION:

Specially designed mounting hardware and a unique canopy design makes E1-I easy to install and maintain. Designed to mount cleanly in the center of ceiling tile or sheetrock ceiling.

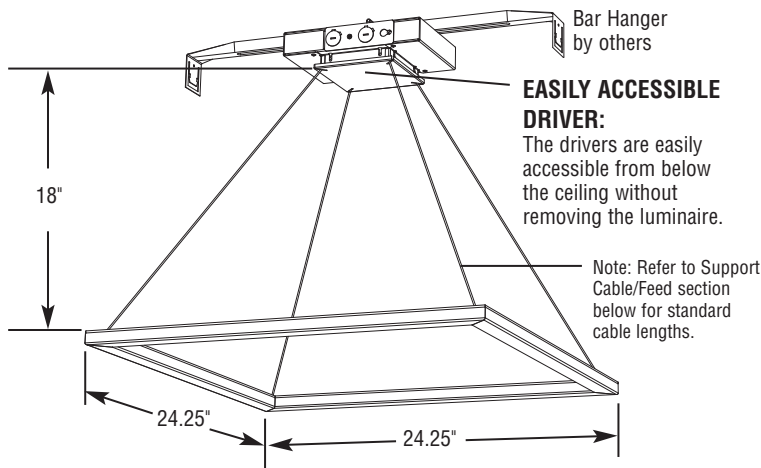

### STANDARD CONFIGURATION DIMENSIONS

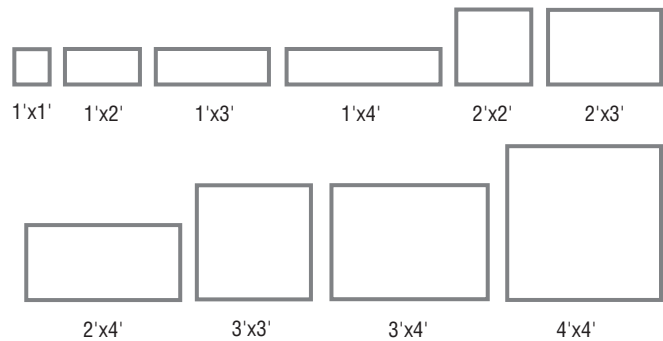

### SPECIFICATIONS

**CONSTRUCTION:** Precision cut 6061-T6 extruded aluminum body with mitered corners. Top Glow™ diffuser snaps into place and is easily removed for service.

**UPLIGHT DIFFUSER:** The Top Glow™ diffuser is frosted white standard, 89% transmissive, 99% diffusion. Coupled with light engine design, the diffuser spreads the light evenly for enhanced ceiling uniformity.

**LIGHT OUTPUT:** Four lumen packages available, Standard Output (S), Boosted Standard Output (B), High Output (H), and Very High Output (V). A separate chart summarizes lumen distribution and wattage. Light engines are replaceable.

**LIGHT ENGINE:** The light engine is made up of high performance mid-power LEDs and is designed to distribute heat properly to maximize the life of the LEDs and the driver.

**LUMEN MAINTENANCE:** 90% of initial light output (L90) at 100,000+ hours; 70% of initial light output (L70) at 200,000+ hours.

**DRIVER:** Replaceable 120V/277V Constant Current Reduction dimming driver standard. Can be wired dimming or non-dimming. 0-10V dimming controls

with a range of 10% - 100%. Dimming to 1% available; consult factory. Driver is fully accessible from below the ceiling. Power Factor:  $\geq 0.9$ . Total Harmonic Distortion (THD)  $< 20\%$ . Step-dimming driver (limited programmable outputs. Contact Factory). Expected driver lifetime: 100,000 hours.

**ELECTRICAL:** 120V or 277V prewired. Emergency to generator/ inverter wiring, internal generator transfer switch, nightlight wiring. Please note: Battery backup not available.

**MOUNTING:** Mounting hardware supplied by Finelite includes  $\frac{1}{4}$  - 20 hardware. Retention arm (bar hanger) for connection to ceiling grid or joists is by others. LED drivers are 100% accessible from below ceiling by simply lowering canopy.

**FINISH:** Finelite Signal White powder coat finish standard. Optional adds: 185 colors available using Tiger Drylac's RAL color chart.

**SUPPORT CABLE/FEED:** Conductive feed/suspension cable standard. Standard suspension for 1'x1', 1'x2', 1'x3', 1'x4', and 2'x2' configurations is 18" from canopy to top of fixture. Standard suspension for 2'x3', 2'x4', 3'x3', 3'x4', and 4'x4' configurations is 24". Contact factory for additional lengths.

**STANDARD CONFIGURATIONS:** Available in 1'x1', 1'x2', 1'x3', 1'x4', 2'x2', 2'x3', 2'x4', 3'x3', 3'x4', and 4'x4' configurations.

**WEIGHT:** 2'x2' E1-I weighs 6 lbs (including power supply).

**LABELS:** Fixture and electrical components are ETL-listed conforming to UL 1598 in the U.S.A. and CAN/CSA C22.2 No. 250.0 in Canada. In accordance with NEC Code 410.73 (G), this luminaire contains an internal driver disconnect. Damp Location. Finelite products use electronic components that are RoHS compliant, and the mechanical components of the luminaire have been verified to not knowingly contain any restricted substances listed per RoHS Directive 2002/95/EC.

**WARRANTY:** E1-I C comes standard with a 10-year performance-based warranty on all components.

Patent Pending

Finelite, Inc. • 30500 Whipple Road • Union City, CA 94587-1530 • 510 / 441-1100 • Fax: 510 / 441-1510 • www.finelite.com

Due to continuing product improvements, Finelite reserves the right to change specifications without notice. Please visit www.finelite.com for most current data.

# Skydome™

LED STEM/CABLE MOUNT

Verrill Dana



FOCAL POINT®

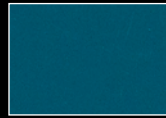

bay blue - gloss



fabulous fuchsia - gloss



golf green - gloss

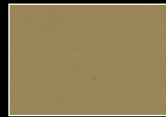

modest mushroom - gloss

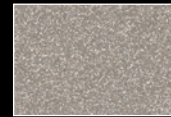

titanium silver



matte black



cable mount canopy detail



surface mount companion



recessed companion

## DIMENSIONAL DATA

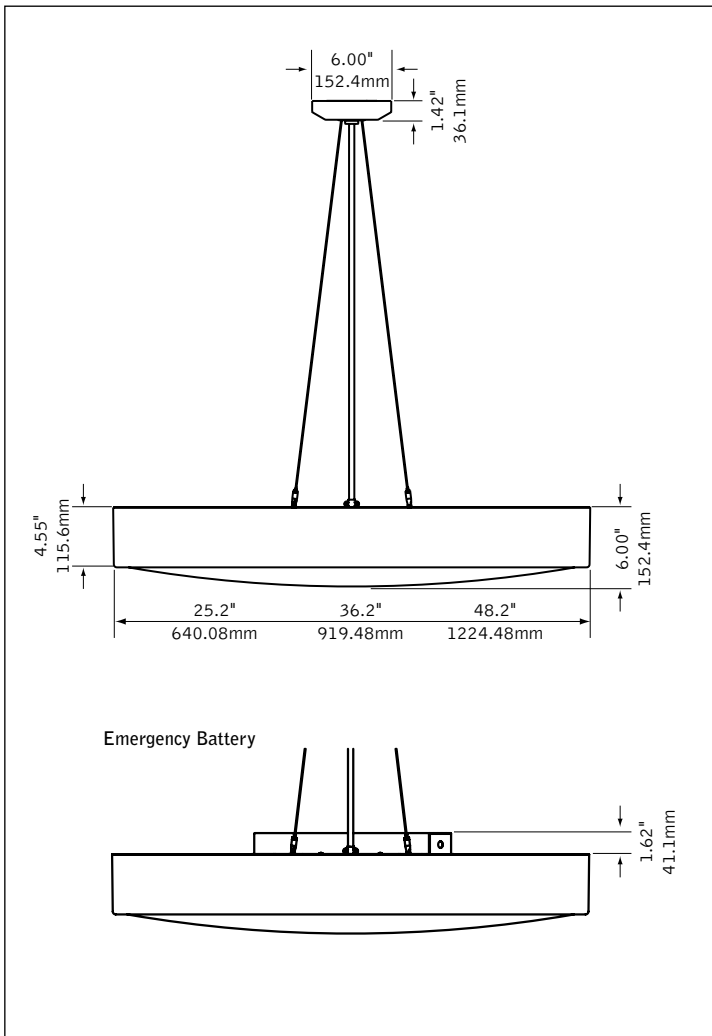

## FEATURES

Pendant mount LED round dome with acrylic diffuser.

Nominal 2', 3' or 4' diameter housings are available.

Shallow 4.5" deep housing maintains low profile.

Convex lens design ensures an evenly illuminated diffuser.

Skydome™ is a good choice for open public spaces such as airport concourses, large lobbies, reception areas, schools and meeting rooms.

## PERFORMANCE

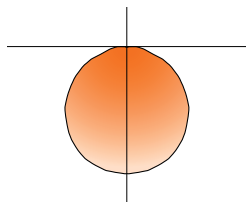

**PRODUCT OVERVIEW**

Lumen Output: 2000-17000lm

Wattage: 25-194W

LPW: 71-90

SDCM: 3

Lumen Maintenance: L70 @ 76,000hrs

4' Diameter  
7000 Lumen Nominal Output  
**Delivered Lumens: 7000lm**  
**Total System Watts: 77W**

Photometric performance is measured in accordance with IESNA LM-79. Visit focalpointlights.com for complete photometric data.

fixture:

project:

**STEM MOUNTING INFORMATION**

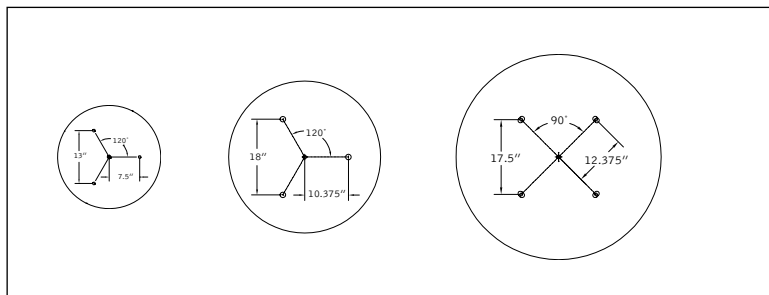

**SPECIFICATIONS**

**LED System**

LED module incorporates premium LEDs on a robust platform to achieve excellent thermal management. LEDs are placed to promote a uniform appearance. Available in 3000K, 3500K or 4000K with CRI>80. LED modules and drivers are replaceable from below.

**Construction**

18 Ga. spun steel housing. 18 Ga. spun steel mounting pan. Housing available in 25.2", 36.12" or 48.2" diameter x 4.5"H. Housing secured to mounting pan by torsion springs. 12" minimum suspension. 2' unit weight: 23lbs, 3' unit weight: 50lbs, 4' unit weight: 72lbs.

**Optic**

20 Ga. steel reflector finished in High Reflectance White powder coat. Convex lens of .125" thick white acrylic is secured to housing and removed with torsion springs.

**Electrical**

Standard 120-277V driver includes 0-10V analog dimming. Power factor > .9. Optional EcoSystem™ driver from Lutron available.

**Emergency Battery**

Bodine BSL310-CAN. Emergency output—10 watts for 90 minutes.

**Labels**

UL and cUL listed. Suitable for Dry or Damp Locations, indoor use only.

**Finish**

Polyester powder coat applied over a 5-stage pre-treatment.

**Lumen Maintenance**

Calculated: L70 at 76,000 hours      Reported: L70 at >54,000 hours  
 Derived from EPA TM-21 calculator

**Warranty**

LED system rated for operation in ambient environments up to 25°C. 5 year limited warranty.

**PERFORMANCE CHART**

Nominal Size	Delivered Lumens	Tested System Watts	LPW
2'	2000	25	80
	3000	39	77
	4000	56	71
3'	4000	48	83
	5000	61	82
	7000	87	80
4'	9000	117	77
	7000	77	91
	9000	100	90
4'	11000	123	89
	14000	159	88
	17000	194	88

\*Lumen output may vary +/- 5%. Actual wattage may vary +/- 5%

**ORDERING**

Luminaire Series	FSDL	FSDL
Skydome LED	FSDL	_____
<b>Nominal Size</b>		_____
2' Diameter	22	_____
3' Diameter	33	_____
4' Diameter	44	_____
<b>Shielding</b>		<b>CX</b> _____
Frosted Lens	CX	_____
<b>Lumen Output</b>		_____
2' Diameter		_____
2000 Lumen	2000L	_____
3000 Lumen	3000L	_____
4000 Lumen	4000L	_____
3' Diameter		_____
4000 Lumen	4000L	_____
5000 Lumen	5000L	_____
7000 Lumen	7000L	_____
9000 Lumen	9000L	_____
4' Diameter		_____
7000 Lumen	7000L	_____
9000 Lumen	9000L	_____
11,000 Lumen	11000L	_____
14,000 Lumen	14000L	_____
17,000 Lumen	17000L	_____
<b>Color Temperature</b>		_____
3000K	30K	_____
3500K	35K	_____
4000K	40K	_____
<b>Circuit</b>		<b>1C</b> _____
Single Circuit	1C	_____
<b>Voltage</b>		_____
120 Volt	120	_____
277 Volt	277	_____
UNV Volt	UNV	_____
<small>(Cannot be specified with EM option)</small>		
<b>Driver</b>		_____
0-10V - 1% Dimming	L11	_____
0-10V - 10% Dimming	LD1	_____
Lutron A-Series	L3D	_____
1% EcoSystem Digital		_____
<small>(Consult factory for 3-wire control)</small>		
<b>Mounting</b>		_____
24" Aircraft Cable	C24	_____
48" Aircraft Cable	C48	_____
96" Aircraft Cable	C96	_____
12" Rigid Stem	S12	_____
18" Rigid Stem	S18	_____
24" Rigid Stem	S24	_____
36" Rigid Stem	S36	_____
48" Rigid Stem	S48	_____
<small>(White stems and canopies supplied standard. For non-white housings: to match stem and housing color, add M to ordering code (S12M). To match stem, canopy and housing color, add MC to ordering code (S12MC) (Consult factory for other lengths)</small>		
<b>Factory Options</b>		_____
Emergency Battery*	EM	_____
Solid Top Cover Plate	TC	_____
<small>(Painted to match housing. Not available with EM.)</small>		
<b>Finish</b>		_____
Matte Satin White	WH	_____
Gloss White	HW	_____
Titanium Silver	TS	_____
Matte Black	BK	_____
Bay Blue - Gloss	BB	_____
Fabulous Fuschia - Gloss	FF	_____
Golf Green - Gloss	GG	_____
Modest Mushroom - Gloss	MM	_____



# Skydome™

LED - 2' SUSPENDED

FSDL-22-2000L-35K-LD1-120-SM-CX-WH

Filename: FSDL222000L35KSM.IES

Lumens: 2000lm

System Watts: 25W

LPW: 80

### CANDLEPOWER DISTRIBUTION

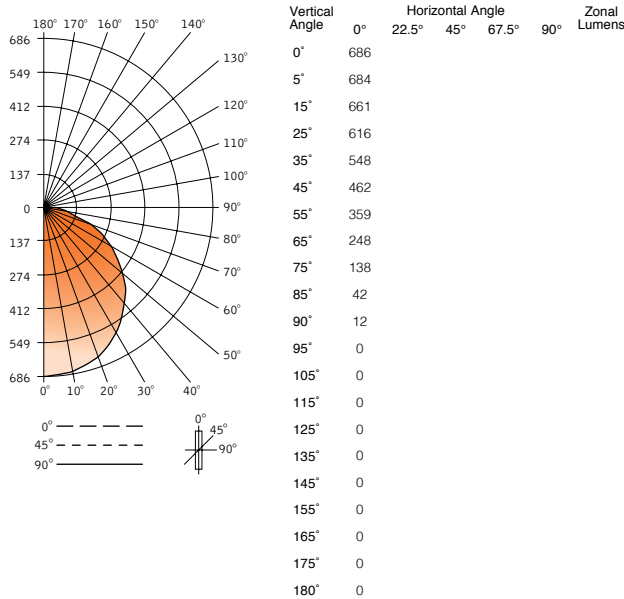

### LUMEN SUMMARY

Zone	Lumens	% Lamp	% Fixture
0-30°	536	26.8	
0-40°	878	43.9	
0-60°	1555	77.8	
0-90°	1997	99.8	
<b>Total Luminaire</b>	<b>0-180°</b>	<b>2000</b>	<b>100.0</b>

### LUMINANCE DATA (CD/M²)

Vertical Angle	0°	45°	90°
45°	2320	2320	2320
55°	2180	2180	2180
65°	1982	1982	1982
75°	1677	1677	1677
85°	1145	1145	1145

Go to [www.focalpointlights.com](http://www.focalpointlights.com) for additional photometric data.

# Skydome™

LED - 2' SUSPENDED

FSDL-22-4000L-35K-LD1-120-SM-CX-WH

Filename: FSDL224000L35KSM.IES

Lumens: 4000lm

System Watts: 56W

LPW: 71

### CANDLEPOWER DISTRIBUTION

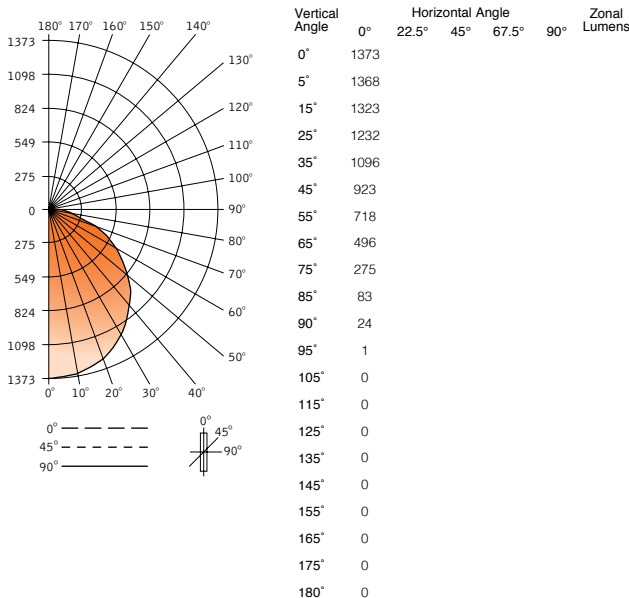

### LUMEN SUMMARY

Zone	Lumens	% Fixture	
0-30°	1071	26.8	
0-40°	1757	43.9	
0-60°	3111	77.8	
0-90°	3993	99.8	
<b>Total Luminaire</b>	<b>0-180°</b>	<b>4000</b>	<b>100.0</b>

### LUMINANCE DATA (CD/M²)

Vertical Angle	0°	45°	90°
45°	4640	4640	4640
55°	4360	4360	4360
65°	3964	3964	3964
75°	3354	3354	3354
85°	2289	2289	2289

Go to [www.focalpointlights.com](http://www.focalpointlights.com) for additional photometric data.



# Skydome™

LED - 3' SUSPENDED

FSDL-33-4000L-35K-LD1-120-SM-CX-WH

Filename: FSDL334000L35KSM.IES

Lumens: 4000lm

System Watts: 48W

LPW: 83

## CANDLEPOWER DISTRIBUTION

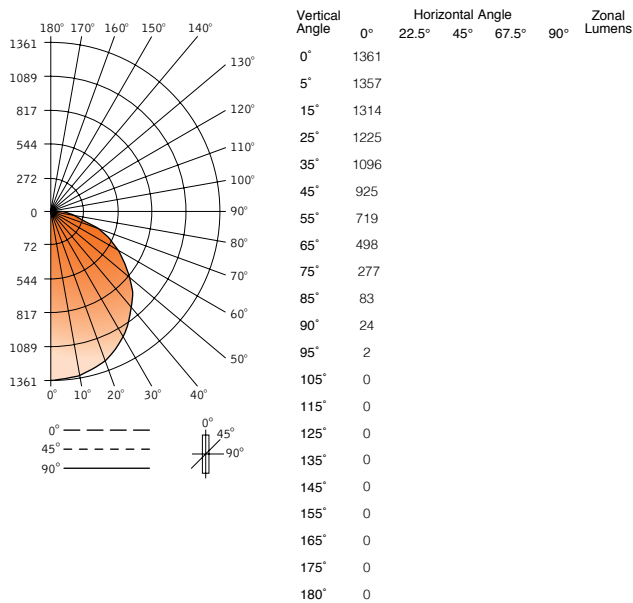

## LUMEN SUMMARY

Zone	Lumens	% Lamp	% Fixture
0-30°	1064	26.6	
0-40°	1750	43.7	
0-60°	3106	77.7	
0-90°	3992	99.8	
<b>Total Luminaire 0-180°</b>	<b>4000</b>	<b>100.0</b>	

## LUMINANCE DATA (CD/M<sup>2</sup>)

Vertical Angle	0°	45°	90°
45°	2132	2132	2132
55°	2006	2006	2006
65°	1828	1828	1828
75°	1554	1554	1554
85°	1053	1053	1053

Go to [www.focalpointlights.com](http://www.focalpointlights.com) for additional photometric data.

# Skydome™

LED - 3' SUSPENDED

FSDL-33-9000L-35K-LD1-120-SM-CX-WH

Filename: FSDL339000L35KSM.IES

Lumens: 9000lm

System Watts: 117W

LPW: 77

## CANDLEPOWER DISTRIBUTION

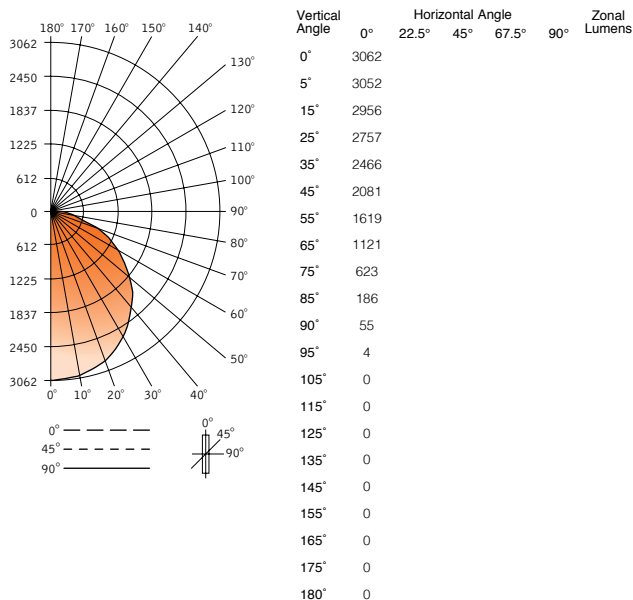

## LUMEN SUMMARY

Zone	Lumens	% Fixture
0-30°	2395	26.6
0-40°	3937	43.7
0-60°	6989	77.7
0-90°	8983	99.8
<b>Total Luminaire 0-180°</b>	<b>9000</b>	<b>100.0</b>

## LUMINANCE DATA (CD/M<sup>2</sup>)

Vertical Angle	0°	45°	90°
45°	4798	4798	4798
55°	4513	4513	4513
65°	4114	4114	4114
75°	3497	3497	3497
85°	2370	2370	2370

Go to [www.focalpointlights.com](http://www.focalpointlights.com) for additional photometric data.

# Skydome™

LED - 4' SUSPENDED

FSDL-44-7000L-35K-LD1-120-SM-CX-WH

Filename: FSDL447000L35KSM.IES

Lumens: 7000lm

System Watts: 77W

LPW: 91

### CANDLEPOWER DISTRIBUTION

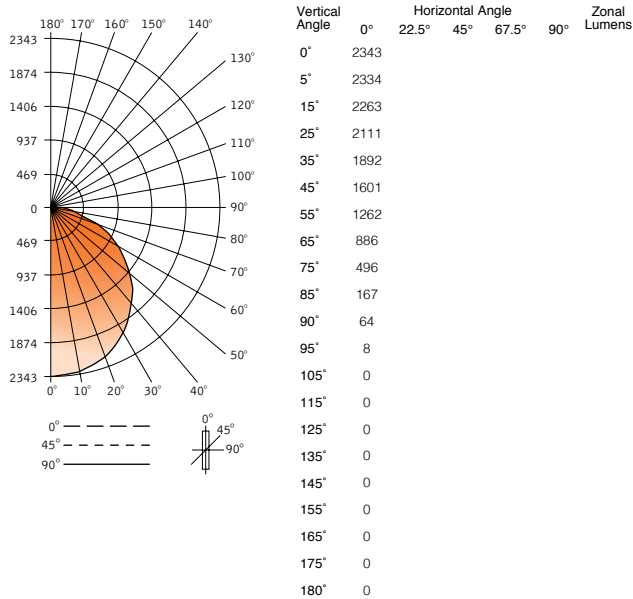

### LUMEN SUMMARY

Zone	Lumens	% Lamp	% Fixture
0-30°	1834	26.2	
0-40°	3017	43.1	
0-60°	5380	76.9	
0-90°	6978	99.7	
<b>Total Luminaire 0-180°</b>	<b>7000</b>	<b>100.0</b>	

Go to [www.focalpointlights.com](http://www.focalpointlights.com) for additional photometric data.

# Skydome™

LED - 4' SUSPENDED

FSDL-44-17000L-35K-LD1-120-SM-CX-WH

Filename: FSDL4417000L35KSM.IES

Lumens: 17000lm

System Watts: 194W

LPW: 88

### CANDLEPOWER DISTRIBUTION

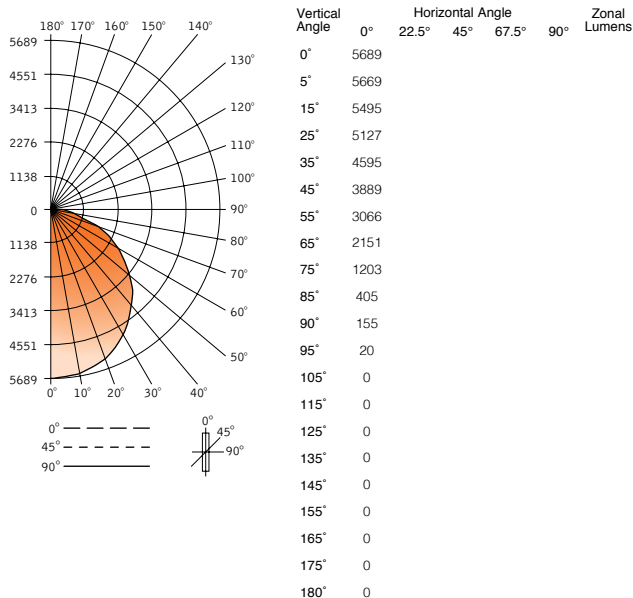

### LUMEN SUMMARY

Zone	Lumens	% Fixture
0-30°	4454	26.2
0-40°	7327	43.1
0-60°	13066	76.9
0-90°	16946	99.7
<b>Total Luminaire 0-180°</b>	<b>17000</b>	<b>100.0</b>

Go to [www.focalpointlights.com](http://www.focalpointlights.com) for additional photometric data.

# Skydome™

LED STEM/CABLE MOUNT

Verrill Dana



FOCAL POINT®

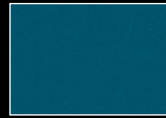

bay blue - gloss



fabulous fuchsia - gloss



golf green - gloss

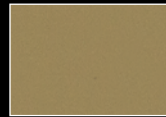

modest mushroom - gloss

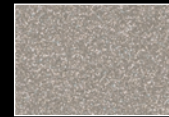

titanium silver



matte black



cable mount canopy detail



surface mount companion



recessed companion

## DIMENSIONAL DATA

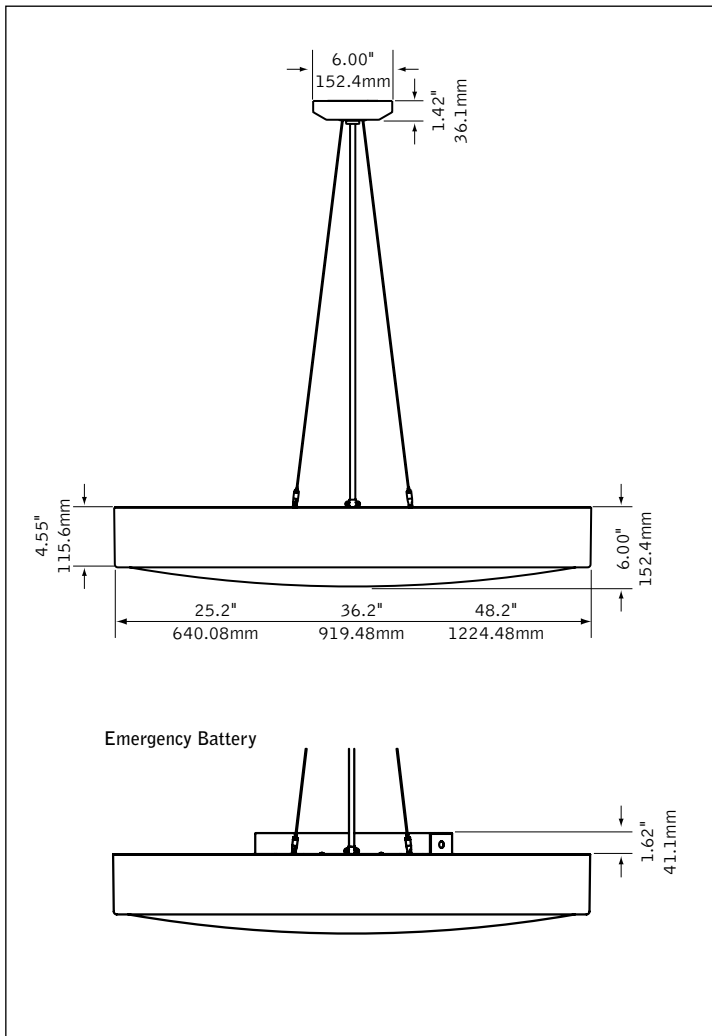

## FEATURES

Pendant mount LED round dome with acrylic diffuser.

Nominal 2', 3' or 4' diameter housings are available.

Shallow 4.5" deep housing maintains low profile.

Convex lens design ensures an evenly illuminated diffuser.

Skydome™ is a good choice for open public spaces such as airport concourses, large lobbies, reception areas, schools and meeting rooms.

## PERFORMANCE

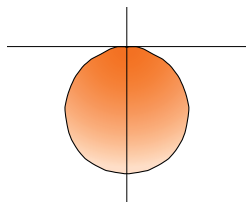

**PRODUCT OVERVIEW**

Lumen Output: 2000-17000lm

Wattage: 25-194W

LPW: 71-90

SDCM: 3

Lumen Maintenance: L70 @ 76,000hrs

4' Diameter  
7000 Lumen Nominal Output  
**Delivered Lumens: 7000lm**  
**Total System Watts: 77W**

Photometric performance is measured in accordance with IESNA LM-79. Visit focalpointlights.com for complete photometric data.

fixture:

project:

**STEM MOUNTING INFORMATION**

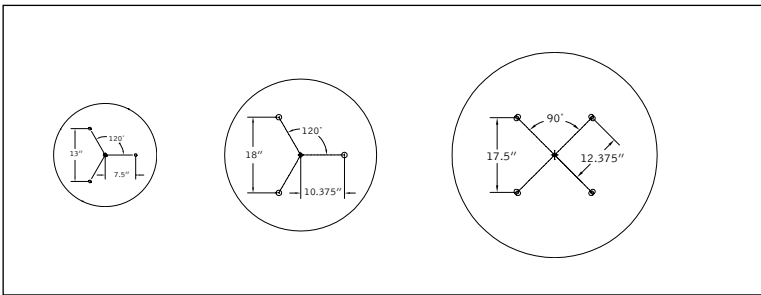

**SPECIFICATIONS**

**LED System**

LED module incorporates premium LEDs on a robust platform to achieve excellent thermal management. LEDs are placed to promote a uniform appearance. Available in 3000K, 3500K or 4000K with CRI>80. LED modules and drivers are replaceable from below.

**Construction**

18 Ga. spun steel housing. 18 Ga. spun steel mounting pan. Housing available in 25.2", 36.12" or 48.2" diameter x 4.5"H. Housing secured to mounting pan by torsion springs. 12" minimum suspension. 2' unit weight: 23lbs, 3' unit weight: 50lbs, 4' unit weight: 72lbs.

**Optic**

20 Ga. steel reflector finished in High Reflectance White powder coat. Convex lens of .125" thick white acrylic is secured to housing and removed with torsion springs.

**Electrical**

Standard 120-277V driver includes 0-10V analog dimming. Power factor > .9. Optional EcoSystem™ driver from Lutron available.

**Emergency Battery**

Bodine BSL310-CAN. Emergency output—10 watts for 90 minutes.

**Labels**

UL and cUL listed. Suitable for Dry or Damp Locations, indoor use only.

**Finish**

Polyester powder coat applied over a 5-stage pre-treatment.

**Lumen Maintenance**

Calculated: L70 at 76,000 hours      Reported: L70 at >54,000 hours  
Derived from EPA TM-21 calculator

**Warranty**

LED system rated for operation in ambient environments up to 25°C. 5 year limited warranty.

**PERFORMANCE CHART**

Nominal Size	Delivered Lumens	Tested System Watts	LPW
2'	2000	25	80
	3000	39	77
	4000	56	71
3'	4000	48	83
	5000	61	82
	7000	87	80
	9000	117	77
4'	7000	77	91
	9000	100	90
	11000	123	89
	14000	159	88
	17000	194	88

\*Lumen output may vary +/- 5%. Actual wattage may vary +/- 5%

**ORDERING**

Luminaire Series	FSDL	FSDL
Skydome LED	FSDL	_____
<b>Nominal Size</b>		_____
2' Diameter	22	_____
3' Diameter	33	_____
4' Diameter	44	_____
<b>Shielding</b>		<b>CX</b> _____
Frosted Lens	CX	_____
<b>Lumen Output</b>		_____
2' Diameter		_____
2000 Lumen	2000L	_____
3000 Lumen	3000L	_____
4000 Lumen	4000L	_____
3' Diameter		_____
4000 Lumen	4000L	_____
5000 Lumen	5000L	_____
7000 Lumen	7000L	_____
9000 Lumen	9000L	_____
4' Diameter		_____
7000 Lumen	7000L	_____
9000 Lumen	9000L	_____
11,000 Lumen	11000L	_____
14,000 Lumen	14000L	_____
17,000 Lumen	17000L	_____
<b>Color Temperature</b>		_____
3000K	30K	_____
3500K	35K	_____
4000K	40K	_____
<b>Circuit</b>		<b>1C</b> _____
Single Circuit	1C	_____
<b>Voltage</b>		_____
120 Volt	120	_____
277 Volt	277	_____
UNV Volt	UNV	_____
<small>(Cannot be specified with EM option)</small>		
<b>Driver</b>		_____
0-10V - 1% Dimming	L11	_____
0-10V - 10% Dimming	LD1	_____
Lutron A-Series	L3D	_____
1% EcoSystem Digital		_____
<small>(Consult factory for 3-wire control)</small>		
<b>Mounting</b>		_____
24" Aircraft Cable	C24	_____
48" Aircraft Cable	C48	_____
96" Aircraft Cable	C96	_____
12" Rigid Stem	S12	_____
18" Rigid Stem	S18	_____
24" Rigid Stem	S24	_____
36" Rigid Stem	S36	_____
48" Rigid Stem	S48	_____
<small>(White stems and canopies supplied standard. For non-white housings: to match stem and housing color, add M to ordering code (S12M). To match stem, canopy and housing color, add MC to ordering code (S12MC) (Consult factory for other lengths)</small>		
<b>Factory Options</b>		_____
Emergency Battery*	EM	_____
Solid Top Cover Plate	TC	_____
<small>(Painted to match housing. Not available with EM.)</small>		
<b>Finish</b>		_____
Matte Satin White	WH	_____
Gloss White	HW	_____
Titanium Silver	TS	_____
Matte Black	BK	_____
Bay Blue - Gloss	BB	_____
Fabulous Fuschia - Gloss	FF	_____
Golf Green - Gloss	GG	_____
Modest Mushroom - Gloss	MM	_____

# Skydome™

LED - 2' SUSPENDED

FSDL-22-2000L-35K-LD1-120-SM-CX-WH

Filename: FSDL222000L35KSM.IES

Lumens: 2000lm

System Watts: 25W

LPW: 80

### CANDLEPOWER DISTRIBUTION

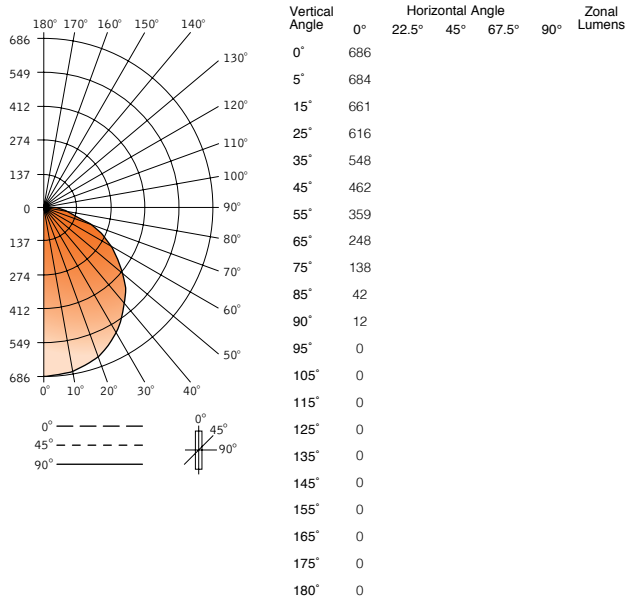

### LUMEN SUMMARY

Zone	Lumens	% Lamp	% Fixture
0-30°	536	26.8	
0-40°	878	43.9	
0-60°	1555	77.8	
0-90°	1997	99.8	
<b>Total Luminaire</b>	<b>0-180°</b>	<b>2000</b>	<b>100.0</b>

### LUMINANCE DATA (CD/M²)

Vertical Angle	0°	45°	90°
45°	2320	2320	2320
55°	2180	2180	2180
65°	1982	1982	1982
75°	1677	1677	1677
85°	1145	1145	1145

Go to [www.focalpointlights.com](http://www.focalpointlights.com) for additional photometric data.

# Skydome™

LED - 2' SUSPENDED

FSDL-22-4000L-35K-LD1-120-SM-CX-WH

Filename: FSDL224000L35KSM.IES

Lumens: 4000lm

System Watts: 56W

LPW: 71

### CANDLEPOWER DISTRIBUTION

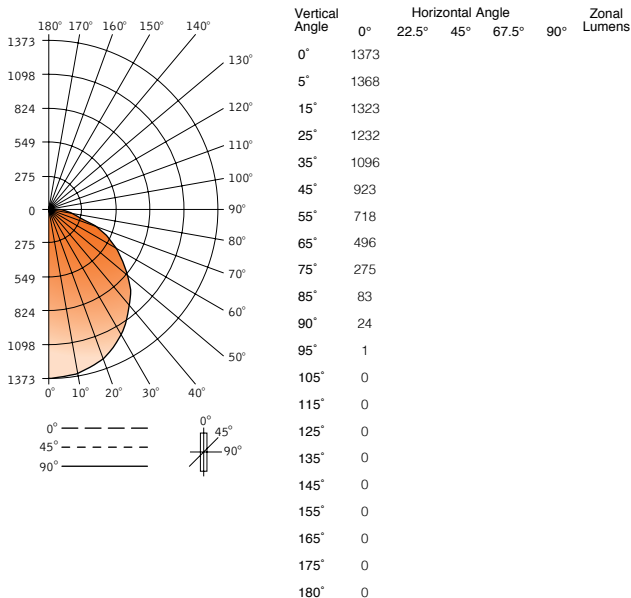

### LUMEN SUMMARY

Zone	Lumens	% Fixture	
0-30°	1071	26.8	
0-40°	1757	43.9	
0-60°	3111	77.8	
0-90°	3993	99.8	
<b>Total Luminaire</b>	<b>0-180°</b>	<b>4000</b>	<b>100.0</b>

### LUMINANCE DATA (CD/M²)

Vertical Angle	0°	45°	90°
45°	4640	4640	4640
55°	4360	4360	4360
65°	3964	3964	3964
75°	3354	3354	3354
85°	2289	2289	2289

Go to [www.focalpointlights.com](http://www.focalpointlights.com) for additional photometric data.

# Skydome™

LED - 3' SUSPENDED

FSDL-33-4000L-35K-LD1-120-SM-CX-WH

Filename: FSDL334000L35KSM.IES

Lumens: 4000lm

System Watts: 48W

LPW: 83

## CANDLEPOWER DISTRIBUTION

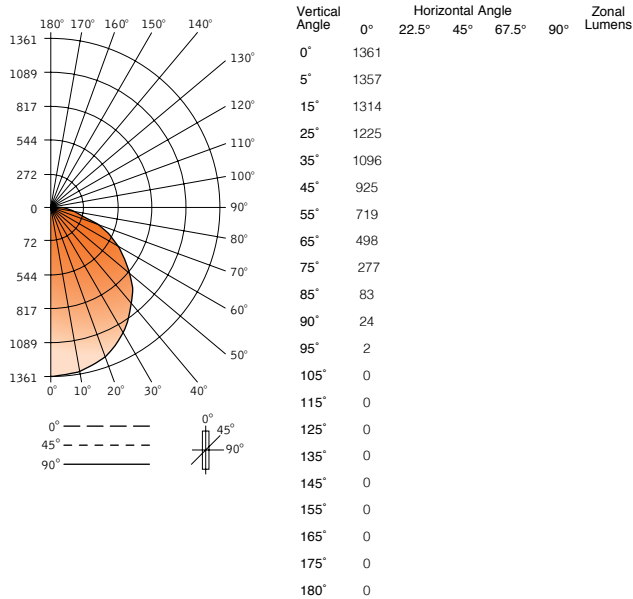

## LUMEN SUMMARY

Zone	Lumens	% Lamp	% Fixture
0-30°	1064	26.6	
0-40°	1750	43.7	
0-60°	3106	77.7	
0-90°	3992	99.8	
<b>Total Luminaire 0-180°</b>	<b>4000</b>	<b>100.0</b>	

## LUMINANCE DATA (CD/M²)

Vertical Angle	0°	45°	90°
45°	2132	2132	2132
55°	2006	2006	2006
65°	1828	1828	1828
75°	1554	1554	1554
85°	1053	1053	1053

Go to [www.focalpointlights.com](http://www.focalpointlights.com) for additional photometric data.

# Skydome™

LED - 3' SUSPENDED

FSDL-33-9000L-35K-LD1-120-SM-CX-WH

Filename: FSDL339000L35KSM.IES

Lumens: 9000lm

System Watts: 117W

LPW: 77

## CANDLEPOWER DISTRIBUTION

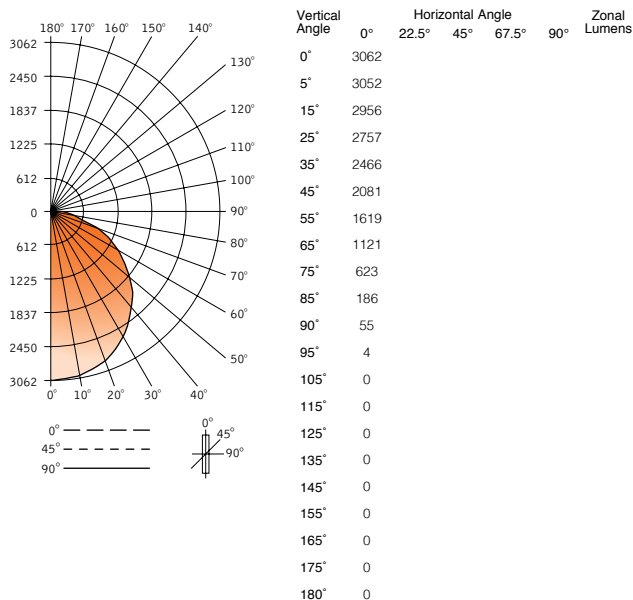

## LUMEN SUMMARY

Zone	Lumens	% Fixture
0-30°	2395	26.6
0-40°	3937	43.7
0-60°	6989	77.7
0-90°	8983	99.8
<b>Total Luminaire 0-180°</b>	<b>9000</b>	<b>100.0</b>

## LUMINANCE DATA (CD/M²)

Vertical Angle	0°	45°	90°
45°	4798	4798	4798
55°	4513	4513	4513
65°	4114	4114	4114
75°	3497	3497	3497
85°	2370	2370	2370

Go to [www.focalpointlights.com](http://www.focalpointlights.com) for additional photometric data.

# Skydome™

LED - 4' SUSPENDED

FSDL-44-7000L-35K-LD1-120-SM-CX-WH

Filename: FSDL447000L35KSM.IES

Lumens: 7000lm

System Watts: 77W

LPW: 91

## CANDLEPOWER DISTRIBUTION

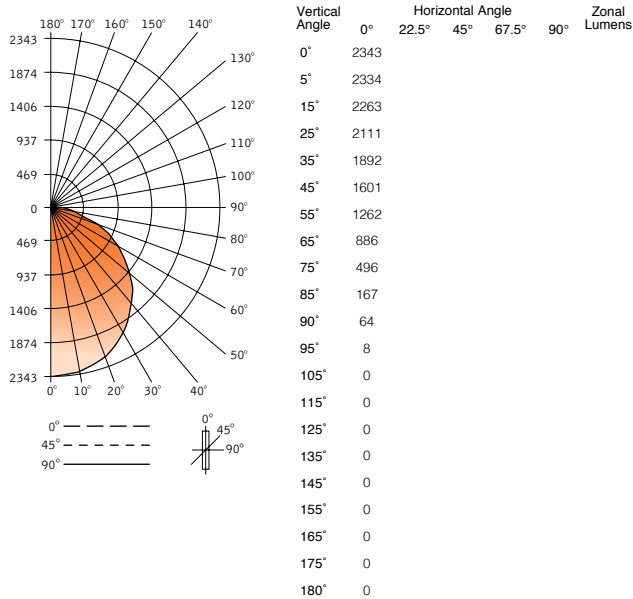

## LUMEN SUMMARY

Zone	Lumens	% Lamp	% Fixture
0-30°	1834	26.2	
0-40°	3017	43.1	
0-60°	5380	76.9	
0-90°	6978	99.7	
<b>Total Luminaire</b>	<b>0-180°</b>	<b>7000</b>	<b>100.0</b>

Go to [www.focalpointlights.com](http://www.focalpointlights.com) for additional photometric data.

# Skydome™

LED - 4' SUSPENDED

FSDL-44-17000L-35K-LD1-120-SM-CX-WH

Filename: FSDL4417000L35KSM.IES

Lumens: 17000lm

System Watts: 194W

LPW: 88

## CANDLEPOWER DISTRIBUTION

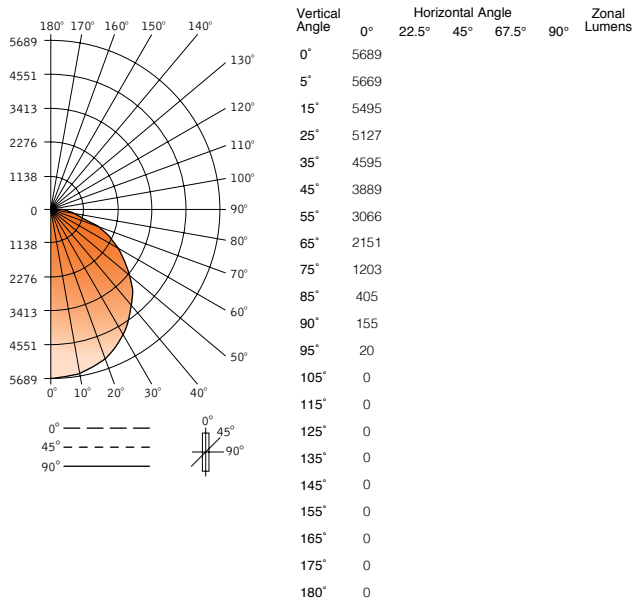

## LUMEN SUMMARY

Zone	Lumens	% Lamp	% Fixture
0-30°	4454	26.2	
0-40°	7327	43.1	
0-60°	13066	76.9	
0-90°	16946	99.7	
<b>Total Luminaire</b>	<b>0-180°</b>	<b>17000</b>	<b>100.0</b>

Go to [www.focalpointlights.com](http://www.focalpointlights.com) for additional photometric data.

# FINELITE

## High Performance 2" Aperture (HP-2) - Direct



Date

Project

Type

Comments

Signal White is standard finish

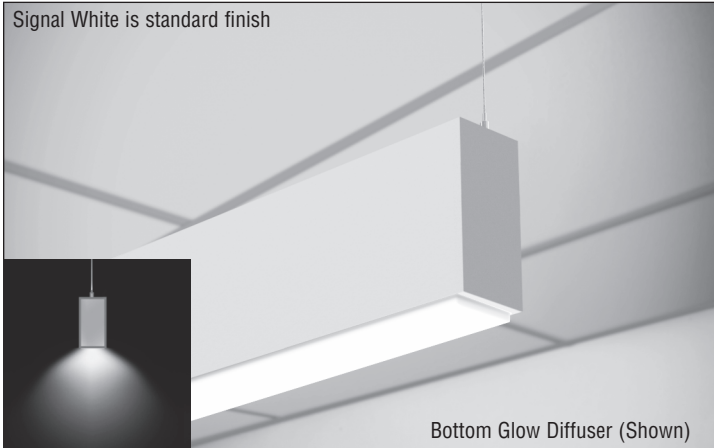

Bottom Glow Diffuser (Shown)

### DESCRIPTION

High Performance 2" Aperture Direct (HP-2 D) is a patented, linear LED luminaire with Flush and Bottom Glow™ options for the downlight. The micro shape delivers excellent performance using an advanced optical design and mid-power LEDs to achieve 90% of initial light output at 100,000 hours.

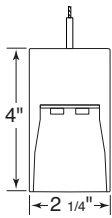

Flush Downlight Diffuser (Standard)

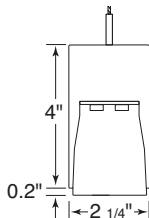

Bottom Glow Diffuser (Optional)

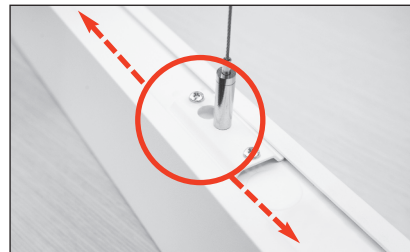

### FLEXIBLE MOUNTING

The flexible mounting bracket adjusts the suspension points along the length of the luminaire to accommodate existing architecture. Suspension points adjust up to 2' in from the end of 8' or 12' fixture lengths and up to 1' in on shorter lengths.

## Tailored Lighting 10 working days

### TAILORED LIGHTING

Any length greater than 2 feet, in increments down to 1/16th-inch (± 1/32") and 90-degree mitered corners in a single plane.

### ORDERING GUIDE

Sample Number: HP-2 D - 32' - H - 8 - 35 - F - 120V - FA - SC - C1 - OBO



#### Finelite Series HP-2 D

Length (Minimum 2', increments accurate to 1/16th" (± 1/32"), Standard) \_\_\_\_\_

Light Output (S - Standard Output, B - Boosted Standard Output, \_\_\_\_\_  
H - High Output, V - Very High Output)

LED CRI (8 - 80 CRI Min (standard), 9 - 90 CRI Min (optional)) \_\_\_\_\_

LED Color Temperature (30 - 3000K, 35 - 3500K, 40 - 4000K) \_\_\_\_\_

Downlight Diffuser (F - Flush (standard), BG - Bottom Glow (optional)) \_\_\_\_\_

Voltage (120V, 277V) \_\_\_\_\_

Mounting (FA - Fully Adjustable, FM - Flexible Mounting) \_\_\_\_\_

Circuiting (SC - Single Circuit)\* \_\_\_\_\_

Ceiling Type (C1 - 1" T-Bar, C2 - 9/16" T-Bar, C3 - Screw Slot, C4 - Hard Ceiling) \_\_\_\_\_

Integrated Sensor (OBO - Occupancy Sensor, OBD - Daylight) \_\_\_\_\_

\*Contact factory for switching options.

Protected by one or more US Patents: 8915613; D702,391; D702,390; D700,732; D727,554 S; D727,550 S, D727,551 S

Finelite, Inc. • 30500 Whipple Road • Union City, CA 94587-1530 • 510 / 441-1100 • Fax: 510 / 441-1510 • www.finelite.com

Due to continuing product improvements, Finelite reserves the right to change specifications without notice. Please visit www.finelite.com for most current data.



# FINELITE

## High Performance 2" Aperture (HP-2) - Direct

### PHOTOMETRY

Very High Output - 4' Luminaire

Efficacy: 87.1 lumen per watt

Total luminaire output: 3215 lumens (804 lumens/foot)  
36.9 watts (9.2 watts/foot)

Peak Candela Value: 1334 @ 0°

CCT: 3500K

ITL LM79 Report 85136

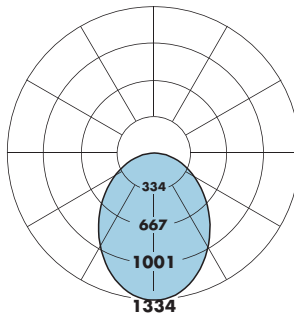

### CANDLEPOWER SUMMARY

	0.0	22.5	45	67.5	90	Flux
0	1334	1334	1334	1334	1334	
5	1327	1326	1326	1325	1324	126
15	1263	1252	1251	1244	1236	352
25	1133	1117	1109	1088	1075	508
35	958	942	923	896	887	576
45	762	747	725	697	686	558
55	563	551	532	509	500	475
65	374	365	351	337	331	349
75	206	201	195	188	184	207
85	62	61	59	57	57	66
90	0	0	0	0	0	

### Total Light Output, 3500K, 80 CRI (Lumens) - 4' Luminaire

S*	B*	H*	V**
1316	1655	2501	3215

### Light Output, 3500K, 80 CRI (Lumens Per Foot)

S*	B*	H*	V**
329	414	625	804

### Power, 3500K (Watts Per Foot)

S*	B*	H*	V**
3.6	4.6	7.1	9.2

### Efficacy, 3500K, 80 CRI (Lumens Per Watt)

S*	B*	H*	V**
91.1	90.2	88.3	87.1

S - Standard Output, B - Boosted Standard Output, H - High Output, V - Very High Output

\* Family Correlation based on 4' luminaire 3500K Very High Output (V) test - 120V.

\*\* Correlation based on ITL report: 85136

### Lumen Adjustment Factors - 80 CRI

3000K	0.985
3500K	1.000
4000K	1.032

### Lumen Adjustment Factors - 90 CRI

3000K	0.746
3500K	0.760
4000K	0.789

Apply a lumen adjustment factor to calculate lumens for the desired CCT and CRI.

### SAMPLE LUMEN ADJUSTMENT CALCULATION

High Output (H), 4000K, 90 CRI

Lumen Adjustment Factor = 0.789

$$\text{Total Light Output} = 2501 \text{ lm} \times 0.789 = 1973 \text{ lm}$$

$$\text{Total Light Output per Foot} = 625 \text{ lm/ft} \times 0.789 = 493 \text{ lm/ft}$$

$$\text{watts/foot} = 7.1 \text{ W/ft}$$

$$\text{Efficacy} = \frac{493 \frac{\text{lm}}{\text{ft}}}{7.1 \frac{\text{W}}{\text{ft}}} = 69.4 \text{ lm/W}$$

Protected by one or more US Patents: 8915613; D702,391; D702,390; D700,732; D727,554 S; D727,550 S, D727,551 S

Finelite, Inc. • 30500 Whipple Road • Union City, CA 94587-1530 • 510 / 441-1100 • Fax: 510 / 441-1510 • www.finelite.com

Due to continuing product improvements, Finelite reserves the right to change specifications without notice. Please visit www.finelite.com for most current data.



BUY AMERICAN ACT

Verrill Dana  
OF 2009 COME LIGHT

# FINELITE

## High Performance 2" Aperture (HP-2) - Direct

### SPECIFICATIONS

**CONSTRUCTION:** Precision-cut 6061-T6 extruded aluminum body. Internal joiner system, plug-together wiring, standard.

**ENDCAPS:** Flat diecast aluminum endcaps add 0.25" to each end of luminaire.

**MITERED CORNER:** Illuminated 90° corners in a single plane, with Flush downlight diffuser, standard. Custom angles are available (90° minimum on inside corners), contact factory.

**REFLECTORS:** Die-formed 24-gauge cold-rolled steel reflectors are finished in 96 LG high reflectance matte white powder coat paint.

**DOWNLIGHT DIFFUSER:** 12' maximum lens length. Flush frost white snap-in lens standard, 73%transmissive, 99% diffusion. Internal secondary diffusers at corners ensure visually seamless, uniform, continuous illumination. Optional: Bottom Glow™ frost white snap-in lens option, 73% transmissive, 99% diffusion.

**LIGHT OUTPUT:** Four lumen packages available, Standard Output (S), Boosted Standard Output (B), High Output (H), and Very High Output (V). A separate chart summarizes lumen distribution and wattage. Light engines are replaceable.

**LUMEN MAINTENANCE:** 90% of initial light output (L90) at 100,000+ hours; 70% of initial light output (L70) at 200,000+ hours.

**DRIVER:** Replaceable 120V/277V Constant Current Reduction dimming driver standard. Can be wired dimming or non-dimming. 0-10V dimming controls with a range of 10%- 100%. Dimming to 1% available; consult factory. Driver is fully accessible from below the ceiling. Power Factor: ≥0.9. Total Harmonic Distortion (THD) <20%. Expected driver lifetime: 100,000 hours.

**LUTRON DRIVER OPTIONS:** Lut3W-3-wire, LutES-EcoSystem, Lut2W-2-wire.

**ELECTRICAL:** Optional emergency to generator/inverter wiring, internal generator transfer switch, nightlight wiring, step-dimming driver, backup battery. Factory-choice low-profile backup battery available. 8' minimum fixture length for low profile battery pack. Backup batteries deliver 1000 lumens. Half of a 4' section will be illuminated in emergency mode.



**INTEGRATED SENSORS:** Integrated PIR (Passive Infrared) occupancy and/or daylight sensors available with Flush and Bottom Glow downlight diffusers. Refer to Occupancy Sensor and Daylight Sensor tech sheets for more info.

**MOUNTING:** 50" Fully Adjustable (FA) plated steel aircraft cable with safety stop hardware standard. Contact factory for additional lengths up to 150". The Flexible Mounting Bracket (FM) adjusts the suspension points to accommodate existing architecture. Suspension points adjust up to 2' in from the end of 8' or 12' fixture lengths and up to 1' in on shorter lengths.

**FINISHES:** Finelite Signal White powder coat standard. Optional Adders: 185 Tiger Drylac's RAL colors.

**FEED:** Standard with one 18-gauge/5-conductor single-circuit feed. 14-gauge feed used when fixture current exceeds 5 amps.

**LENGTHS:** Any length, 2-foot minimum, in increments down to 1/16th-inch (± 1/32").

**LABELS:** Fixture and electrical components are ETL-listed conforming to UL 1598 in the U.S.A. and CAN/CSA C22.2 No. 250.0 in Canada. In accordance with NEC Code 410.73 (G), this luminaire contains an internal driver disconnect. Damp Location. Finelite products use electronic components that are RoHS compliant, and the mechanical components of the luminaire have been verified to not knowingly contain any restricted substances listed per RoHS Directive 2002/95/EC.

**WEIGHT:** 2.3 lb/ft.

**WARRANTY:** 10-year performance-based warranty on all standard components. Optional accessories such as emergency battery packs are covered by their individual manufacturer warranties.

Protected by one or more US Patents: 8915613; D702,391; D702,390; D700,732; D727,554 S; D727,550 S, D727,551 S

Finelite, Inc. • 30500 Whipple Road • Union City, CA 94587-1530 • 510 / 441-1100 • Fax: 510 / 441-1510 • www.finelite.com

Due to continuing product improvements, Finelite reserves the right to change specifications without notice. Please visit www.finelite.com for most current data.

# FINELITE

## High Performance 2" Aperture (HP-2) - Direct



Date

Project

Type

Comments

Signal White is standard finish

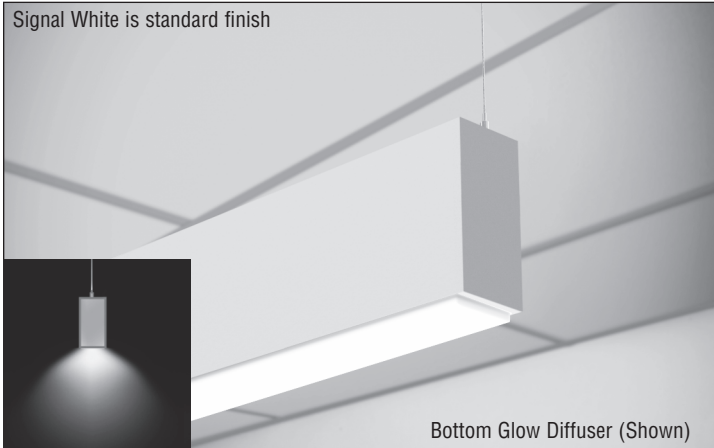

Bottom Glow Diffuser (Shown)

### DESCRIPTION

High Performance 2" Aperture Direct (HP-2 D) is a patented, linear LED luminaire with Flush and Bottom Glow™ options for the downlight. The micro shape delivers excellent performance using an advanced optical design and mid-power LEDs to achieve 90% of initial light output at 100,000 hours.

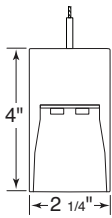

Flush Downlight Diffuser (Standard)

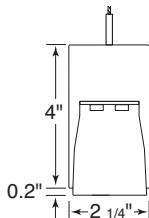

Bottom Glow Diffuser (Optional)

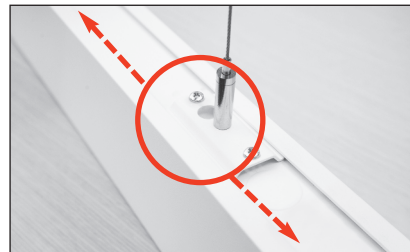

### FLEXIBLE MOUNTING

The flexible mounting bracket adjusts the suspension points along the length of the luminaire to accommodate existing architecture. Suspension points adjust up to 2' in from the end of 8' or 12' fixture lengths and up to 1' in on shorter lengths.

## Tailored Lighting 10 working days

### TAILORED LIGHTING

Any length greater than 2 feet, in increments down to 1/16th-inch (± 1/32") and 90-degree mitered corners in a single plane.

### ORDERING GUIDE

Sample Number: HP-2 D - 32' - H - 8 - 35 - F - 120V - FA - SC - C1 - OBO



#### Finelite Series HP-2 D

Length (Minimum 2', increments accurate to 1/16th" (± 1/32"), Standard) \_\_\_\_\_

Light Output (S - Standard Output, B - Boosted Standard Output, \_\_\_\_\_  
H - High Output, V - Very High Output)

LED CRI (8 - 80 CRI Min (standard), 9 - 90 CRI Min (optional)) \_\_\_\_\_

LED Color Temperature (30 - 3000K, 35 - 3500K, 40 - 4000K) \_\_\_\_\_

Downlight Diffuser (F - Flush (standard), BG - Bottom Glow (optional)) \_\_\_\_\_

Voltage (120V, 277V) \_\_\_\_\_

Mounting (FA - Fully Adjustable, FM - Flexible Mounting) \_\_\_\_\_

Circuiting (SC - Single Circuit)\* \_\_\_\_\_

Ceiling Type (C1 - 1" T-Bar, C2 - 9/16" T-Bar, C3 - Screw Slot, C4 - Hard Ceiling) \_\_\_\_\_

Integrated Sensor (OBO - Occupancy Sensor, OBD - Daylight) \_\_\_\_\_

\*Contact factory for switching options.

Protected by one or more US Patents: 8915613; D702,391; D702,390; D700,732; D727,554 S; D727,550 S, D727,551 S

Finelite, Inc. • 30500 Whipple Road • Union City, CA 94587-1530 • 510 / 441-1100 • Fax: 510 / 441-1510 • www.finelite.com

Due to continuing product improvements, Finelite reserves the right to change specifications without notice. Please visit www.finelite.com for most current data.

# FINELITE

## High Performance 2" Aperture (HP-2) - Direct

### PHOTOMETRY

Very High Output - 4' Luminaire

Efficacy: 87.1 lumen per watt

Total luminaire output: 3215 lumens (804 lumens/foot)  
36.9 watts (9.2 watts/foot)

Peak Candela Value: 1334 @ 0°

CCT: 3500K

ITL LM79 Report 85136

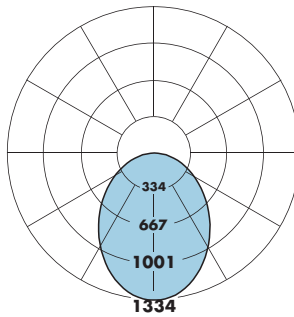

### CANDLEPOWER SUMMARY

	0.0	22.5	45	67.5	90	Flux
0	1334	1334	1334	1334	1334	
5	1327	1326	1326	1325	1324	126
15	1263	1252	1251	1244	1236	352
25	1133	1117	1109	1088	1075	508
35	958	942	923	896	887	576
45	762	747	725	697	686	558
55	563	551	532	509	500	475
65	374	365	351	337	331	349
75	206	201	195	188	184	207
85	62	61	59	57	57	66
90	0	0	0	0	0	

### Total Light Output, 3500K, 80 CRI (Lumens) - 4' Luminaire

S*	B*	H*	V**
1316	1655	2501	3215

### Light Output, 3500K, 80 CRI (Lumens Per Foot)

S*	B*	H*	V**
329	414	625	804

### Power, 3500K (Watts Per Foot)

S*	B*	H*	V**
3.6	4.6	7.1	9.2

### Efficacy, 3500K, 80 CRI (Lumens Per Watt)

S*	B*	H*	V**
91.1	90.2	88.3	87.1

S - Standard Output, B - Boosted Standard Output, H - High Output, V - Very High Output

\* Family Correlation based on 4' luminaire 3500K Very High Output (V) test - 120V.

\*\* Correlation based on ITL report: 85136

### Lumen Adjustment Factors - 80 CRI

3000K	0.985
3500K	1.000
4000K	1.032

### Lumen Adjustment Factors - 90 CRI

3000K	0.746
3500K	0.760
4000K	0.789

Apply a lumen adjustment factor to calculate lumens for the desired CCT and CRI.

### SAMPLE LUMEN ADJUSTMENT CALCULATION

High Output (H), 4000K, 90 CRI

Lumen Adjustment Factor = 0.789

$$\text{Total Light Output} = 2501 \text{ lm} \times 0.789 = 1973 \text{ lm}$$

$$\text{Total Light Output per Foot} = 625 \text{ lm/ft} \times 0.789 = 493 \text{ lm/ft}$$

$$\text{watts/foot} = 7.1 \text{ W/ft}$$

$$\text{Efficacy} = \frac{493 \frac{\text{lm}}{\text{ft}}}{7.1 \frac{\text{W}}{\text{ft}}} = 69.4 \text{ lm/W}$$

Protected by one or more US Patents: 8915613; D702,391; D702,390; D700,732; D727,554 S; D727,550 S, D727,551 S

Finelite, Inc. • 30500 Whipple Road • Union City, CA 94587-1530 • 510 / 441-1100 • Fax: 510 / 441-1510 • www.finelite.com

Due to continuing product improvements, Finelite reserves the right to change specifications without notice. Please visit www.finelite.com for most current data.



# FINELITE

## High Performance 2" Aperture (HP-2) - Direct

### SPECIFICATIONS

**CONSTRUCTION:** Precision-cut 6061-T6 extruded aluminum body. Internal joiner system, plug-together wiring, standard.

**ENDCAPS:** Flat diecast aluminum endcaps add 0.25" to each end of luminaire.

**MITERED CORNER:** Illuminated 90° corners in a single plane, with Flush downlight diffuser, standard. Custom angles are available (90° minimum on inside corners), contact factory.

**REFLECTORS:** Die-formed 24-gauge cold-rolled steel reflectors are finished in 96 LG high reflectance matte white powder coat paint.

**DOWNLIGHT DIFFUSER:** 12' maximum lens length. Flush frost white snap-in lens standard, 73%transmissive, 99% diffusion. Internal secondary diffusers at corners ensure visually seamless, uniform, continuous illumination. Optional: Bottom Glow™ frost white snap-in lens option, 73% transmissive, 99% diffusion.

**LIGHT OUTPUT:** Four lumen packages available, Standard Output (S), Boosted Standard Output (B), High Output (H), and Very High Output (V). A separate chart summarizes lumen distribution and wattage. Light engines are replaceable.

**LUMEN MAINTENANCE:** 90% of initial light output (L90) at 100,000+ hours; 70% of initial light output (L70) at 200,000+ hours.

**DRIVER:** Replaceable 120V/277V Constant Current Reduction dimming driver standard. Can be wired dimming or non-dimming. 0-10V dimming controls with a range of 10%- 100%. Dimming to 1% available; consult factory. Driver is fully accessible from below the ceiling. Power Factor: ≥0.9. Total Harmonic Distortion (THD) <20%. Expected driver lifetime: 100,000 hours.

**LUTRON DRIVER OPTIONS:** Lut3W-3-wire, LutES-EcoSystem, Lut2W-2-wire.

**ELECTRICAL:** Optional emergency to generator/inverter wiring, internal generator transfer switch, nightlight wiring, step-dimming driver, backup battery. Factory-choice low-profile backup battery available. 8' minimum fixture length for low profile battery pack. Backup batteries deliver 1000 lumens. Half of a 4' section will be illuminated in emergency mode.



**INTEGRATED SENSORS:** Integrated PIR (Passive Infrared) occupancy and/or daylight sensors available with Flush and Bottom Glow downlight diffusers. Refer to Occupancy Sensor and Daylight Sensor tech sheets for more info.

**MOUNTING:** 50" Fully Adjustable (FA) plated steel aircraft cable with safety stop hardware standard. Contact factory for additional lengths up to 150". The Flexible Mounting Bracket (FM) adjusts the suspension points to accommodate existing architecture. Suspension points adjust up to 2' in from the end of 8' or 12' fixture lengths and up to 1' in on shorter lengths.

**FINISHES:** Finelite Signal White powder coat standard. Optional Adders: 185 Tiger Drylac's RAL colors.

**FEED:** Standard with one 18-gauge/5-conductor single-circuit feed. 14-gauge feed used when fixture current exceeds 5 amps.

**LENGTHS:** Any length, 2-foot minimum, in increments down to 1/16th-inch (± 1/32").

**LABELS:** Fixture and electrical components are ETL-listed conforming to UL 1598 in the U.S.A. and CAN/CSA C22.2 No. 250.0 in Canada. In accordance with NEC Code 410.73 (G), this luminaire contains an internal driver disconnect. Damp Location. Finelite products use electronic components that are RoHS compliant, and the mechanical components of the luminaire have been verified to not knowingly contain any restricted substances listed per RoHS Directive 2002/95/EC.

**WEIGHT:** 2.3 lb/ft.

**WARRANTY:** 10-year performance-based warranty on all standard components. Optional accessories such as emergency battery packs are covered by their individual manufacturer warranties.

Protected by one or more US Patents: 8915613; D702,391; D702,390; D700,732; D727,554 S; D727,550 S, D727,551 S

Finelite, Inc. • 30500 Whipple Road • Union City, CA 94587-1530 • 510 / 441-1100 • Fax: 510 / 441-1510 • www.finelite.com

Due to continuing product improvements, Finelite reserves the right to change specifications without notice. Please visit www.finelite.com for most current data.

# FINELITE

## High Performance 2" Aperture (HP-2) - Indirect/Direct



Date

Project

Type

Comments

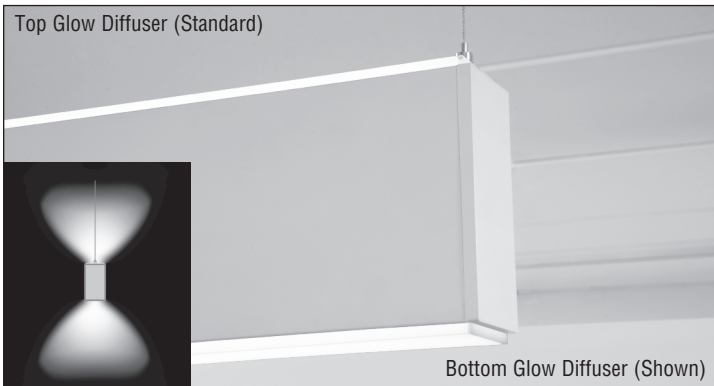

### DESCRIPTION

High Performance 2" aperture Indirect/Direct (HP-2 ID) is a patented, linear LED luminaire with Flush, Top Glow™ and Bottom Glow™ options for up- and downlight. The micro shape delivers excellent performance using an advanced optical design and mid-power LEDs to achieve 90% of initial light output at 100,000 hours.

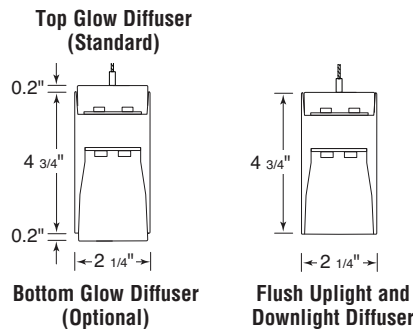

### BOTTOM GLOW DIFFUSER

The optional Bottom Glow diffuser adds a clean line of light along the downlight element.

## Tailored Lighting 10 working days

### TAILORED LIGHTING

Any length greater than 2 feet, in increments down to 1/16th-inch (± 1/32") and 90-degree mitered corners in a single plane.

### DIMENSIONS & DIFFUSER

A glare-free experience is attained with mid-power LEDs and a precise diffuser to eliminate pixilation.

### ORDERING GUIDE

Sample Number: HP-2 ID - 32' - S - H - 8 - 35 - TG - F - 120V - FA - SC - C1 - OBO

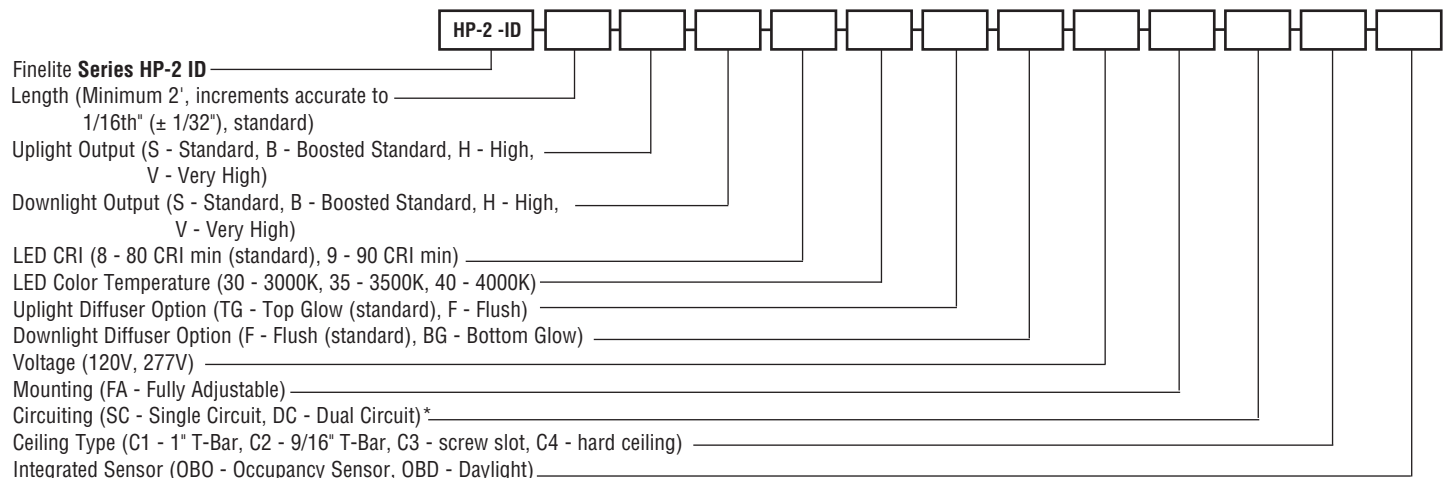

\* Contact factory for switching options.

Protected by one or more US Patents: 8915613; D702,391; D702,390; D700,732; D727,554 S; D727,550 S, D727,551 S

Finelite, Inc. • 30500 Whipple Road • Union City, CA 94587-1530 • 510 / 441-1100 • Fax: 510 / 441-1510 • www.finelite.com

Due to continuing product improvements, Finelite reserves the right to change specifications without notice. Please visit www.finelite.com for most current data.



# FINELITE

## High Performance 2" Aperture (HP-2) - Indirect/Direct

### PHOTOMETRY

Very High Output / Very High Output - 4' Luminaire  
 Distribution: 55% Up (V) / 45% Down (V)  
 Efficacy: 94.7 lumens per watt  
 Uplight: 3813 lumens (953 lumens/foot)  
 Downlight: 3175 lumens (794 lumens/foot)  
 Total luminaire output: 6988 lumens (1747 lumens/foot)  
 73.8 watts (18.5 watts/foot)  
 CCT: 3500K  
 ITL LM79 Report 85132

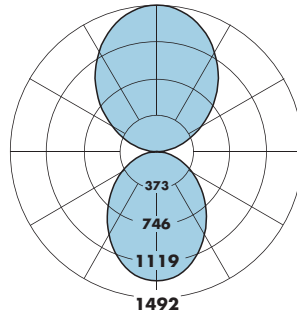

	0.0	22.5	45	67.5	90	Flux
0	1314	1314	1314	1314	1314	
5	1306	1307	1305	1304	1304	124
15	1241	1233	1231	1225	1220	346
25	1114	1098	1089	1076	1064	501
35	942	925	910	887	877	568
45	749	734	718	693	683	552
55	553	542	526	506	499	470
65	368	360	349	337	332	346
75	203	198	192	187	184	204
85	60	59	58	57	55	64
90	0	0	0	0	0	
95	71	68	68	69	70	77
105	244	241	236	235	234	252
115	442	439	437	427	425	431
125	661	649	653	643	638	581
135	884	871	875	866	866	673
145	1099	1084	1088	1084	1077	679
155	1283	1268	1275	1269	1263	585
165	1415	1405	1408	1406	1403	396
175	1482	1482	1482	1482	1481	141
180	1492	1492	1492	1492	1492	

↑ Indirect      ↓ Direct

	↑S*	↑B*	↑H*	↑V**
↓S*	2861 [↑55%   45%↓]	3262 [↑60%   40%↓]	4265 [↑70%   30%↓]	5113 [↑75%   25%↓]
↓B*	3195 [↑49%   51%↓]	3596 [↑55%   45%↓]	4600 [↑65%   35%↓]	5447 [↑70%   30%↓]
↓H*	4030 [↑39%   61%↓]	4432 [↑44%   56%↓]	5435 [↑55%   45%↓]	6282 [↑61%   39%↓]
↓V*	4736 [↑33%   67%↓]	5137 [↑38%   62%↓]	6141 [↑48%   52%↓]	6988 [↑55%   45%↓]

3000K	0.985
3500K	1.000
4000K	1.032

3000K	0.746
3500K	0.760
4000K	0.789

Apply a lumen adjustment factor to calculate lumens for the desired CCT and CRI.

	↑S*	↑B*	↑H*	↑V**
↓S*	715	815	1066	1278
↓B*	799	899	1150	1362
↓H*	1008	1108	1359	1571
↓V*	1184	1284	1535	1747

	↑S*	↑B*	↑H*	↑V**
↓S*	7.2	8.2	10.7	12.8
↓B*	8.2	9.2	11.7	13.8
↓H*	10.7	11.6	14.2	16.3
↓V*	12.8	13.8	16.3	18.5

	↑S*	↑B*	↑H*	↑V**
↓S*	98.8	99.4	99.8	99.6
↓B*	97.4	97.8	98.6	98.6
↓H*	94.3	95.2	96.0	96.3
↓V*	92.2	93.0	94.2	94.7

\* Family Correlation based on 4' luminaire 3500K Very High Output (V) test - 120V.  
 \*\* Correlation based on ITL report: 85132  
 S - Standard Output, B - Boosted Standard Output, H - High Output, V - Very High Output

Protected by one or more US Patents: 8915613; D702,391; D702,390; D700,732; D727,554 S; D727,550 S, D727,551 S

Finelite, Inc. • 30500 Whipple Road • Union City, CA 94587-1530 • 510 / 441-1100 • Fax: 510 / 441-1510 • www.finelite.com

Due to continuing product improvements, Finelite reserves the right to change specifications without notice. Please visit www.finelite.com for most current data.



# FINELITE

## High Performance 2" Aperture (HP-2) - Indirect/Direct

### SPECIFICATIONS

**CONSTRUCTION:** Precision-cut 6061-T6 extruded aluminum body. Internal joiner system, plug-together wiring, standard.

**ENDCAPS:** Flat diecast aluminum endcaps add 0.25" to each end of luminaire.

**MITERED CORNER:** Illuminated 90° corners in a single plane, with Top Glow™ or Flush uplight diffuser, and/or Flush downlight diffuser, standard. Custom angles are available (90° minimum on inside corners), contact factory.

**REFLECTORS:** Die-formed 24-gauge cold-rolled steel reflectors are finished in 96 LG high reflectance matte white powder coat paint.

**UPLIGHT DIFFUSER:** 12' maximum lens length. Top Glow frost white lens standard, 73% transmissive, 99% diffusion. Internal secondary diffusers at corners ensure visually seamless, uniform, continuous illumination. Optional: Flush frost white snap-in lens, 73% transmissive, 99% diffusion.

**DOWNLIGHT DIFFUSER:** 12' maximum lens length. Flush frost white snap-in lens standard, 73% transmissive, 99% diffusion. Internal secondary diffusers at corners ensure visually seamless, uniform, continuous illumination. Optional: Bottom Glow™ frost white snap-in lens option, 73% transmissive, 99% diffusion.

**LIGHT OUTPUT:** Four lumen packages available, Standard Output (S), Boosted Standard Output (B), High Output (H), and Very High Output (V). For lengths 3 feet and greater, the uplight and downlight can be specified with different lumen packages and dual controls. A separate chart summarizes lumen distribution and wattage. Light engines are replaceable.

**LUMEN MAINTENANCE:** 90% of initial light output (L90) at 100,000+ hours; 70% of initial light output (L70) at 200,000+ hours.

**DRIVER:** Replaceable 120V/277V Constant Current Reduction dimming driver standard. Can be wired dimming or non-dimming. 0-10V dimming controls with a range of 10%- 100%. Dimming to 1% available; consult factory. For lengths 3 feet and greater, separate dimming for uplight and downlight available. Driver is fully accessible from below the ceiling. Power Factor: ≥0.9. Total Harmonic Distortion (THD) <20%. Expected driver lifetime: 100,000 hours.

**LUTRON DRIVER OPTIONS:** Lut3W-3-wire, LutES-EcoSystem, Lut2W-2-wire.

**ELECTRICAL:** Optional emergency to generator/inverter wiring, internal generator transfer switch, nightlight wiring, step-dimming driver, backup battery. Factory-choice low-profile backup battery available. 12' minimum luminaire length for low profile battery pack. Backup batteries deliver 1000 lumens. Half of a 4' section will be illuminated in emergency mode.

**INTEGRATED SENSORS:** Integrated PIR (Passive Infrared) occupancy and/or daylight sensors available with Flush and Bottom Glow downlight diffusers. Refer to Occupancy Sensor and Daylight Sensor tech sheets for more info.

**MOUNTING:** 50" Fully Adjustable (FA) plated steel aircraft cable with safety stop hardware standard. Contact factory for additional lengths up to 150".

**FINISHES:** Finelite Signal White powder coat standard. Optional Adders: 185 Tiger Drylac's RAL colors.

**FEED:** Standard with one 18-gauge/5-conductor single-circuit feed controlling uplight and downlight together (power and dimming). Specify dual feeds for independent control of uplight and downlight. 14-gauge feed used when luminaire current exceeds 5 amps.

**LENGTHS:** Any length, 2-foot minimum, in increments down to 1/16th-inch (± 1/32"). 12-foot maximum section length.

**LABELS:** Luminaire and electrical components are ETL-listed conforming to UL 1598 in the U.S.A. and CAN/CSA C22.2 No. 250.0 in Canada. In accordance with NEC Code 410.73 (G), this luminaire contains an internal driver disconnect. Damp Location. Finelite products use electronic components that are RoHS compliant, and the mechanical components of the luminaire have been verified to not knowingly contain any restricted substances listed per RoHS Directive 2002/95/EC.

**WEIGHT:** 2.9 lb/ft.

**WARRANTY:** 10-year performance-based warranty on all standard components. Optional accessories such as emergency battery packs are covered by their individual manufacturer warranties.



Protected by one or more US Patents: 8915613; D702,391; D702,390; D700,732; D727,554 S; D727,550 S, D727,551 S

Finelite, Inc. • 30500 Whipple Road • Union City, CA 94587-1530 • 510 / 441-1100 • Fax: 510 / 441-1510 • www.finelite.com

Due to continuing product improvements, Finelite reserves the right to change specifications without notice. Please visit www.finelite.com for most current data.



# FINELITE

## High Performance 2" Aperture (HP-2) - Direct



Date

Project

Type

Comments

Signal White is standard finish

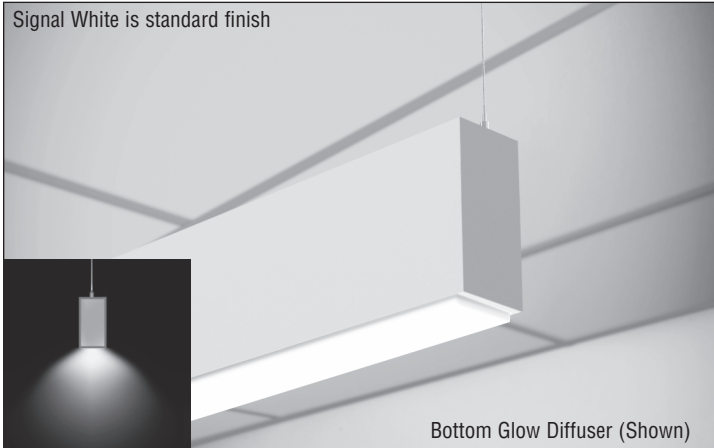

Bottom Glow Diffuser (Shown)

### DESCRIPTION

High Performance 2" Aperture Direct (HP-2 D) is a patented, linear LED luminaire with Flush and Bottom Glow™ options for the downlight. The micro shape delivers excellent performance using an advanced optical design and mid-power LEDs to achieve 90% of initial light output at 100,000 hours.

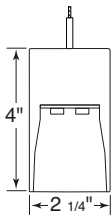

Flush Downlight Diffuser (Standard)

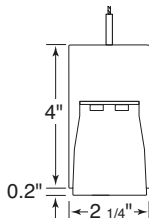

Bottom Glow Diffuser (Optional)

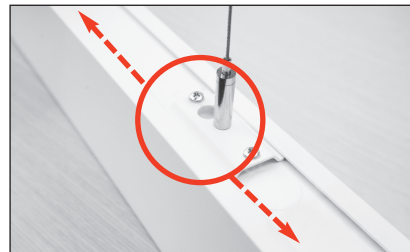

### FLEXIBLE MOUNTING

The flexible mounting bracket adjusts the suspension points along the length of the luminaire to accommodate existing architecture. Suspension points adjust up to 2' in from the end of 8' or 12' fixture lengths and up to 1' in on shorter lengths.

## Tailored Lighting 10 working days

### TAILORED LIGHTING

Any length greater than 2 feet, in increments down to 1/16th-inch (± 1/32") and 90-degree mitered corners in a single plane.

### ORDERING GUIDE

Sample Number: HP-2 D - 32' - H - 8 - 35 - F - 120V - FA - SC - C1 - OBO

Finelite <b>Series HP-2 D</b>	<input type="text" value="HP-2 D"/>
Length (Minimum 2', increments accurate to 1/16th" (± 1/32"), Standard)	<input type="text"/>
Light Output (S - Standard Output, B - Boosted Standard Output, H - High Output, V - Very High Output)	<input type="text"/>
LED CRI (8 - 80 CRI Min (standard), 9 - 90 CRI Min (optional))	<input type="text"/>
LED Color Temperature (30 - 3000K, 35 - 3500K, 40 - 4000K)	<input type="text"/>
Downlight Diffuser (F - Flush (standard), BG - Bottom Glow (optional))	<input type="text"/>
Voltage (120V, 277V)	<input type="text"/>
Mounting (FA - Fully Adjustable, FM - Flexible Mounting)	<input type="text"/>
Circuiting (SC - Single Circuit)*	<input type="text"/>
Ceiling Type (C1 - 1" T-Bar, C2 - 9/16" T-Bar, C3 - Screw Slot, C4 - Hard Ceiling)	<input type="text"/>
Integrated Sensor (OBO - Occupancy Sensor, OBD - Daylight)	<input type="text"/>

\*Contact factory for switching options.

Protected by one or more US Patents: 8915613; D702,391; D702,390; D700,732; D727,554 S; D727,550 S, D727,551 S

Finelite, Inc. • 30500 Whipple Road • Union City, CA 94587-1530 • 510 / 441-1100 • Fax: 510 / 441-1510 • www.finelite.com

Due to continuing product improvements, Finelite reserves the right to change specifications without notice. Please visit www.finelite.com for most current data.

# FINELITE

## High Performance 2" Aperture (HP-2) - Direct

### PHOTOMETRY

Very High Output - 4' Luminaire  
 Efficacy: 87.1 lumen per watt  
 Total luminaire output: 3215 lumens (804 lumens/foot)  
 36.9 watts (9.2 watts/foot)  
 Peak Candela Value: 1334 @ 0°  
 CCT: 3500K  
 ITL LM79 Report 85136

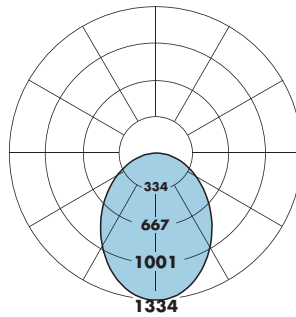

CANDLEPOWER SUMMARY						
	0.0	22.5	45	67.5	90	Flux
0	1334	1334	1334	1334	1334	
5	1327	1326	1326	1325	1324	126
15	1263	1252	1251	1244	1236	352
25	1133	1117	1109	1088	1075	508
35	958	942	923	896	887	576
45	762	747	725	697	686	558
55	563	551	532	509	500	475
65	374	365	351	337	331	349
75	206	201	195	188	184	207
85	62	61	59	57	57	66
90	0	0	0	0	0	

Total Light Output, 3500K, 80 CRI (Lumens) - 4' Luminaire			
S*	B*	H*	V**
1316	1655	2501	3215

Light Output, 3500K, 80 CRI (Lumens Per Foot)			
S*	B*	H*	V**
329	414	625	804

Power, 3500K (Watts Per Foot)			
S*	B*	H*	V**
3.6	4.6	7.1	9.2

Efficacy, 3500K, 80 CRI (Lumens Per Watt)			
S*	B*	H*	V**
91.1	90.2	88.3	87.1

S - Standard Output, B - Boosted Standard Output, H - High Output, V - Very High Output  
 \* Family Correlation based on 4' luminaire 3500K Very High Output (V) test - 120V.  
 \*\* Correlation based on ITL report: 85136

Lumen Adjustment Factors - 80 CRI	
3000K	0.985
3500K	1.000
4000K	1.032

Lumen Adjustment Factors - 90 CRI	
3000K	0.746
3500K	0.760
4000K	0.789

Apply a lumen adjustment factor to calculate lumens for the desired CCT and CRI.

**SAMPLE LUMEN ADJUSTMENT CALCULATION**  
 High Output (H), 4000K, 90 CRI  
 Lumen Adjustment Factor = 0.789

$$\text{Total Light Output} = 2501 \text{ lm} \times 0.789 = 1973 \text{ lm}$$

$$\text{Total Light Output per Foot} = 625 \text{ lm/ft} \times 0.789 = 493 \text{ lm/ft}$$

$$\text{watts/foot} = 7.1 \text{ W/ft}$$

$$\text{Efficacy} = \frac{493 \frac{\text{lm}}{\text{ft}}}{7.1 \frac{\text{W}}{\text{ft}}} = 69.4 \text{ lm/W}$$

Protected by one or more US Patents: 8915613; D702,391; D702,390; D700,732; D727,554 S; D727,550 S, D727,551 S

Finelite, Inc. • 30500 Whipple Road • Union City, CA 94587-1530 • 510 / 441-1100 • Fax: 510 / 441-1510 • www.finelite.com

Due to continuing product improvements, Finelite reserves the right to change specifications without notice. Please visit www.finelite.com for most current data.



# FINELITE

## High Performance 2" Aperture (HP-2) - Direct

### SPECIFICATIONS

**CONSTRUCTION:** Precision-cut 6061-T6 extruded aluminum body. Internal joiner system, plug-together wiring, standard.

**ENDCAPS:** Flat diecast aluminum endcaps add 0.25" to each end of luminaire.

**MITERED CORNER:** Illuminated 90° corners in a single plane, with Flush downlight diffuser, standard. Custom angles are available (90° minimum on inside corners), contact factory.

**REFLECTORS:** Die-formed 24-gauge cold-rolled steel reflectors are finished in 96 LG high reflectance matte white powder coat paint.

**DOWNLIGHT DIFFUSER:** 12' maximum lens length. Flush frost white snap-in lens standard, 73%transmissive, 99% diffusion. Internal secondary diffusers at corners ensure visually seamless, uniform, continuous illumination. Optional: Bottom Glow™ frost white snap-in lens option, 73% transmissive, 99% diffusion.



**LIGHT OUTPUT:** Four lumen packages available, Standard Output (S), Boosted Standard Output (B), High Output (H), and Very High Output (V). A separate chart summarizes lumen distribution and wattage. Light engines are replaceable.

**LUMEN MAINTENANCE:** 90% of initial light output (L90) at 100,000+ hours; 70% of initial light output (L70) at 200,000+ hours.

**DRIVER:** Replaceable 120V/277V Constant Current Reduction dimming driver standard. Can be wired dimming or non-dimming. 0-10V dimming controls with a range of 10%- 100%. Dimming to 1% available; consult factory. Driver is fully accessible from below the ceiling. Power Factor: ≥0.9. Total Harmonic Distortion (THD) <20%. Expected driver lifetime: 100,000 hours.

**LUTRON DRIVER OPTIONS:** Lut3W-3-wire, LutES-EcoSystem, Lut2W-2-wire.

**ELECTRICAL:** Optional emergency to generator/inverter wiring, internal generator transfer switch, nightlight wiring, step-dimming driver, backup battery. Factory-choice low-profile backup battery available. 8' minimum fixture length for low profile battery pack. Backup batteries deliver 1000 lumens. Half of a 4' section will be illuminated in emergency mode.

  **INTEGRATED SENSORS:** Integrated PIR (Passive Infrared) occupancy and/or daylight sensors available with Flush and Bottom Glow downlight diffusers. Refer to Occupancy Sensor and Daylight Sensor tech sheets for more info.

**MOUNTING:** 50" Fully Adjustable (FA) plated steel aircraft cable with safety stop hardware standard. Contact factory for additional lengths up to 150". The Flexible Mounting Bracket (FM) adjusts the suspension points to accommodate existing architecture. Suspension points adjust up to 2' in from the end of 8' or 12' fixture lengths and up to 1' in on shorter lengths.

**FINISHES:** Finelite Signal White powder coat standard. Optional Adders: 185 Tiger Drylac's RAL colors.

**FEED:** Standard with one 18-gauge/5-conductor single-circuit feed. 14-gauge feed used when fixture current exceeds 5 amps.

**LENGTHS:** Any length, 2-foot minimum, in increments down to 1/16th-inch (± 1/32").

**LABELS:** Fixture and electrical components are ETL-listed conforming to UL 1598 in the U.S.A. and CAN/CSA C22.2 No. 250.0 in Canada. In accordance with NEC Code 410.73 (G), this luminaire contains an internal driver disconnect. Damp Location. Finelite products use electronic components that are RoHS compliant, and the mechanical components of the luminaire have been verified to not knowingly contain any restricted substances listed per RoHS Directive 2002/95/EC.

**WEIGHT:** 2.3 lb/ft.

**WARRANTY:** 10-year performance-based warranty on all standard components. Optional accessories such as emergency battery packs are covered by their individual manufacturer warranties.

Protected by one or more US Patents: 8915613; D702,391; D702,390; D700,732; D727,554 S; D727,550 S, D727,551 S

Finelite, Inc. • 30500 Whipple Road • Union City, CA 94587-1530 • 510 / 441-1100 • Fax: 510 / 441-1510 • www.finelite.com

Due to continuing product improvements, Finelite reserves the right to change specifications without notice. Please visit www.finelite.com for most current data.



# id+ 4.5" x 4.5"

LED WALL WASH



white flange



black flange



titanium silver flange



clear diffuse



warm diffuse



trimless companion

## DIMENSIONAL DATA

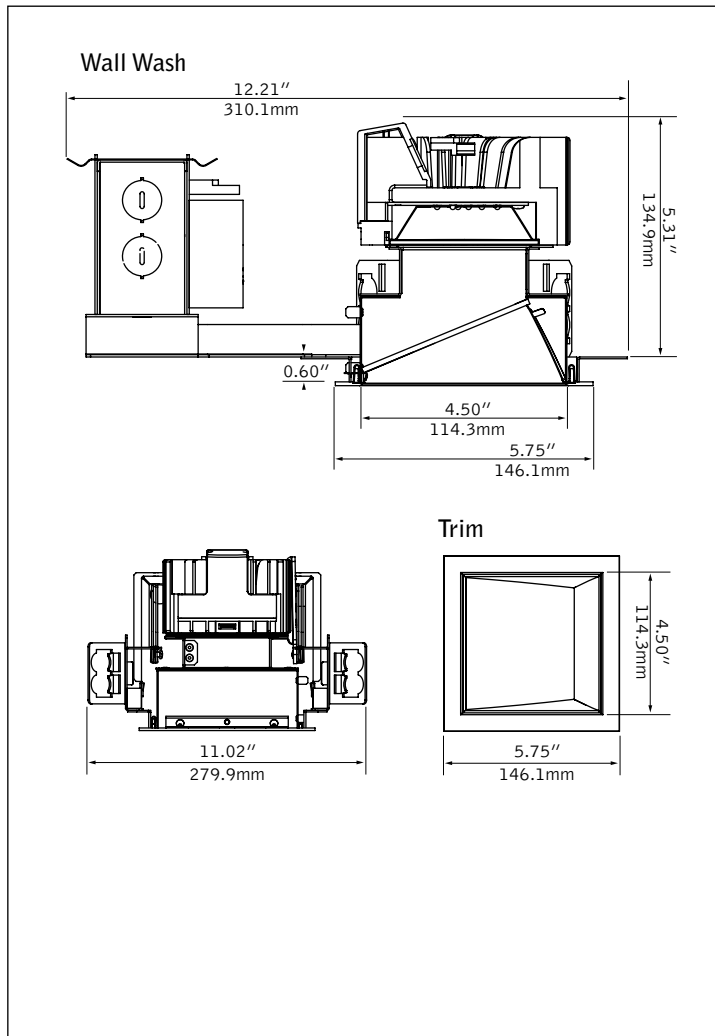

## FEATURES

ChromaSure: Color consistency resulting in a 2-step MacAdam ellipse across the entire ID+ product line.

Field adjustability of ceiling thickness from 0.5" - 2.5".

Shallow housing.

50 degree cutoff to light source and its image.

Selection of dimming drivers available.

Right Light: Standard delivered lumen outputs 500, 1000, 1500, and 2000.

## PERFORMANCE

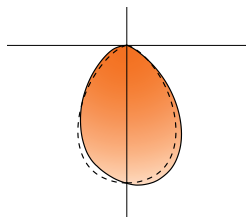

**PRODUCT OVERVIEW**

Lumen Output: 500-2000lm

Wattage: 8-37W

LPW: 54-62

Spacing Criteria: 1.02

SDCM: 2

Lumen Maintenance: L70 @ 63,000hrs

**Clear Diffuse Reflector 3500k**

**Delivered Lumens: 1500lm**

**Total System Watts: 24W**

Photometric performance is measured in accordance with IESNA LM-79. Visit focalpointlights.com for complete photometric data.

**HOUSING DETAILS**

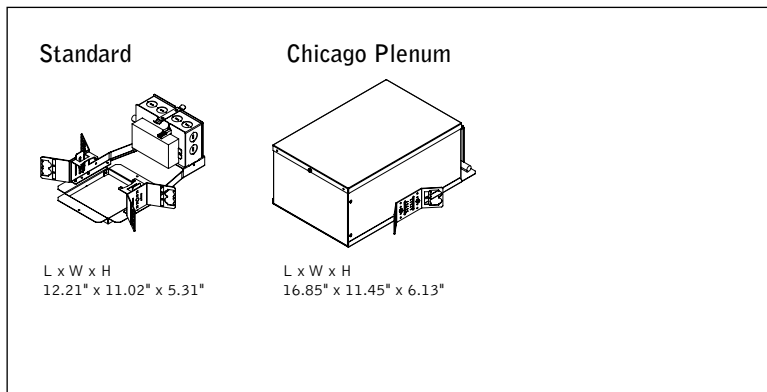

**HOUSING SPECIFICATIONS**

**Construction**

Thermally protected housing for new construction applications. Insulation to be kept 3" away from housing. Butterfly brackets allow mounting to 1/2 emt. Order bar hangers as an accessory. Die-cast aluminum heat sink designed for maximum thermal dissipation. Die-formed housing and integral junction box with (7) 1/2" pry outs. UL & cUL listed for (6) #14 AWG (3 in, 3 out) 90°C conductors and feed through-branch wiring. Accommodates ceiling thicknesses up to 0.5" standard, field adjustable up to 2.5" thickness. For thicker ceiling consult factory. Order TZB option for TechZone compatible housing brackets. Fixture will not exceed 5 lb.

**Electrical**

Choice of constant current dimming drivers. Power factor > .9 typical.

**Labels**

UL and cUL listed. Suitable for Dry or Damp Locations, indoor use only. Specify wet listed (WL) for recessed ceiling applications in indoor and outdoor locations. Lutron Drivers not recommended for outdoor environments below 0°C.

**Lumen Maintenance**

Reported: L70 at >63,000 hours  
Derived from EPA TM-21 calculator

**Warranty**

LED System rated for operation in ambient environments up to 25°C. 5 year limited warranty.

**TRIM & LED SPECIFICATIONS**

**LED System**

Proprietary array incorporates premium LEDs on a robust platform. May be specified in 2700K, 3000K, 3500K or 4000K, CRI>80. Color accuracy within 2 SDCM. Aluminum heat sink provides appropriate thermal management.

**Aesthetics**

Die-formed aluminum reflector ensures glare free optics. Reflector attaches to die-cast, seamless flange and may be removed for field painting. Torsion springs pull trim tight to the ceiling with no visible fasteners within the trim.

**Optics**

55-degree cut-off to light source and its image. Wall wash features acrylic diffuser to provide smooth illumination down the wall.

**PERFORMANCE CHART**

Delivered Lumens	System Watts	LPW
500**	8	60
1000	18	56
1500	24	62
2000	37	54

\*Based on 3000/3500K, Clear Diffuse reflector cone, 80CRI Multipliers: 2700K: 0.94, 4000K: 0.1.06, 90CRI Multipliers: 2700K: 0.71, 3000/3500K: 0.83, 4000K: 0.89, Black Multiplier: 0.56, White Multiplier: 1.13. Lumen output may vary +/- 5%. Actual wattage may vary +/- 5%. \*\*Lutron A-Series 1% EcoSystem Dimming (L3D) delivers 550lm at 11.5W.

**HOUSING ORDERING**

<b>Housing Series</b>	<b>FLC44W</b>
ID+ 4.5" Square Wall Wash	FLC44W
<b>Trim Type</b>	<b>SO</b>
Square Overlap <small>(Click to view trimless cutsheet)</small>	SO
<b>Lumen Output</b>	
500 Lumens	500L
1000 Lumens	1000L
1500 Lumens	1500L
2000 Lumens	2000L
<b>Voltage</b>	
120V	120
277V**	277
<b>Driver</b>	
0-10V - 1% Dimming	L11
0-10V - 10% Dimming	LD1
Lutron A-Series	L3D
1% EcoSystem Digital <small>(Consult factory for 3-wire control)</small>	
DALI - 1% Dimming	D11
<b>Housing Type</b>	<b>T</b>
Thermally Protected, Non-IC	T
<b>Factory Options</b>	
Bar Hangers	BH
Chicago Plenum / National Plenum	CP
TechZone Brackets	TZB
<b>TRIM &amp; LED MODULE</b>	
<b>Aperture</b>	<b>LC44</b>
4.5" Square Reflector	LC44
<b>Trim Type</b>	<b>SQ</b>
Square	SQ
<b>Lumen Output</b>	
500 Lumens	500L
1000 Lumens	1000L
1500 Lumens	1500L
2000 Lumens	2000L
<b>Color Temperature</b>	
2700K	27K
2700K, 90CRI	927K
3000K	30K
3000K, 90CRI	930K
3500K	35K
3500K, 90CRI	935K
4000K	40K
4000K, 90CRI	940K
<b>Optic</b>	<b>WW</b>
Wall Wash	WW
<b>Color</b>	
Clear Diffuse	CD
Warm Diffuse	WD
<b>Flange Finish</b>	
Black	BK
White	WH
Titanium Silver	TS
Aluminum Raw	AL
<b>Factory Options</b>	
Wet Listed <small>(Not available with 90CRI)</small>	WL

A complete unit consists of two line items, housing and trim  
Example: FL44W-SO-1500L-30K-120-LD1-T | L44-SQ-DN-CD-WH



# id+ 4.5" x 4.5"

LED WALL WASH

## FLC44W-SO-1500L-120-L11-T / LC44-SO-1500L-35K-WW-CD-NP

Filename: FLC44WSO1500L\_35K\_40K\_WWCD.IES

Lumens: 1500lm

Test #: 1134956

System Watts: 24W

LPW: 63

### CANDLEPOWER DISTRIBUTION

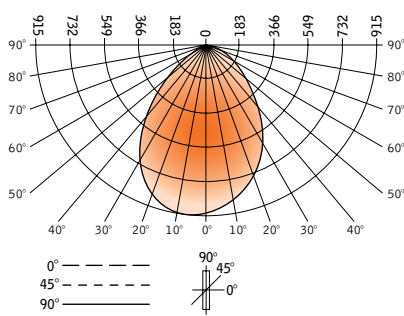

Vertical Angle	Horizontal Angle				
	0°	45°	90°	135°	180°
0°	898	898	898	898	898
5°	874	877	893	906	915
15°	796	805	843	876	887
25°	664	692	710	766	778
35°	499	518	505	567	589
45°	340	340	299	332	364
55°	216	200	148	135	152
65°	135	112	58	29	35
75°	79	51	15	6	5
85°	12	6	2	3	1
90°	0	0	0	0	0

### LUMEN SUMMARY

Zone	Lumens	% Fixture
0-30°	651	43.4
0-40°	984	65.6
0-60°	1391	92.8
0-90°	1500	100.0
<b>Total Luminaire 0-180°</b>	<b>1500</b>	<b>100.0</b>

Go to [www.focalpointlights.com](http://www.focalpointlights.com) for additional photometric data.