

DISPLAY THIS CARD ON PRINCIPAL FRONTAGE OF WORK



# CITY OF PORTLAND BUILDING PERMIT



This is to certify that

PICKWICK PROPERTIES OF MAINE LLC/Norris, Inc.

Located at

536 CONGRESS ST

PERMIT ID: 2012-49761

CBL: 037 H005001

has permission to **Install a fire alarm system**

provided that the person or persons, firm or corporation accepting this permit shall comply with all of the provisions of the Statues of Maine and of the Ordinances of the City of Portland regulating the construction, maintenance and use of the buildings and structures, and of the application on file in the department.

Notification of inspection and written permission procured before this building or part thereof is lathed or otherwise closed-in. 48 HOUR NOTICE IS REQUIRED.

A final inspection must be completed by owner before this building or part thereof is occupied. If a certificate of occupancy is required, it must be procured prior to occupancy.

*Bjorn Wald*

58

Fire Prevention Officer

Code Enforcement Officer / Plan Reviewer

**THIS CARD MUST BE POSTED ON THE STREET SIDE OF THE PROPERTY  
THERE IS A PENALTY FOR REMOVING THIS CARD**

**City of Portland, Maine - Building or Use Permit Application**

389 Congress Street, 04101 Tel: (207) 874-8703, FAX: (207) 8716

|  |   |  |                                    |
|--|---|--|------------------------------------|
| Job No:<br>2012-10-5295-FAFS<br><i>201249761</i>                 | Date Applied:<br>10/29/2012   | CBL:<br>037- H-005-001   |                                    |
| Location of Construction:<br>534, 536, 538 CONGRESS ST           | Owner Name:<br>PICKWICK PROPERTIES OF MAINE, LLC  | Owner Address:<br>PO BOX 17502<br>PORTLAND, ME 04112   | Phone:                             |
| Business Name:   | Contractor Name:<br>Eldee Associates  | Contractor Address:  | Phone:<br>332-1497                 |
| Lessee/Buyer's Name:   | Phone:  | Permit Type:<br>FIRE ALARM   | Zone:<br>B-3                       |
| Past Use:<br><br>Retail 1 <sup>st</sup> floor with offices above | Proposed Use:<br><br>Same: retail 1 <sup>st</sup> floor with offices above – to install fire alarm for 3 tenants on 1 <sup>st</sup> floor at #534, 536, & 538 | Cost of Work:<br>\$9,000.00  | CEO District:                      |
|  |   | Fire Dept:<br><input checked="" type="checkbox"/> Approved <i>w/ conditions</i><br><input type="checkbox"/> Denied<br><input type="checkbox"/> N/A | Inspection:<br>Use Group:<br>Type: |
|  |   | Signature: <i>Björnsdóttir</i> (58)  | Signature:                         |
| Proposed Project Description:<br>Install a fire Alarm            |   | Pedestrian Activities District (P.A.D.)  |                                    |
| Permit Taken By: Lannie  |   | <b>Zoning Approval</b>   |                                    |

|   |  |  |  |
|---|--|--|--|
| <p>1. This permit application does not preclude the Applicant(s) from meeting applicable State and Federal Rules.</p> <p>2. Building Permits do not include plumbing, septic or electrical work.</p> <p>3. Building permits are void if work is not started within six (6) months of the date of issuance. False informatin may invalidate a building permit and stop all work.</p> | <p><b>Special Zone or Reviews</b></p> <p><input type="checkbox"/> Shoreland</p> <p><input type="checkbox"/> Wetlands</p> <p><input type="checkbox"/> Flood Zone</p> <p><input type="checkbox"/> Subdivision</p> <p><input type="checkbox"/> Site Plan</p> <p>___ Maj ___ Min ___ MM</p> <p>Date: <i>10/29/12</i></p> | <p><b>Zoning Appeal</b></p> <p><input type="checkbox"/> Variance</p> <p><input type="checkbox"/> Miscellaneous</p> <p><input type="checkbox"/> Conditional Use</p> <p><input type="checkbox"/> Interpretation</p> <p><input type="checkbox"/> Approved</p> <p><input type="checkbox"/> Denied</p> <p>Date:</p> | <p><b>Historic Preservation</b></p> <p><input type="checkbox"/> Not in Dist or Landmark</p> <p><input type="checkbox"/> Does not Require Review</p> <p><input type="checkbox"/> Requires Review</p> <p><input type="checkbox"/> Approved</p> <p><input type="checkbox"/> Approved w/Conditions</p> <p><input type="checkbox"/> Denied</p> <p>Date:</p> |
|   | <b>CERTIFICATION</b>   |  |  |

I hereby certify that I am the owner of record of the named property, or that the proposed work is authorized by the owner of record and that I have been authorized by the owner to make this application as his authorized agent and I agree to conform to all applicable laws of this jurisdiction. In addition, if a permit for work described in the application is issued, I certify that the code official's authorized representative shall have the authority to enter all areas covered by such permit at any reasonable hour to enforce the provision of the code(s) applicable to such permit.

|   |         |      |       |
|---|---------|------|-------|
| SIGNATURE OF APPLICANT                      | ADDRESS | DATE | PHONE |
|   |         |      |       |
| RESPONSIBLE PERSON IN CHARGE OF WORK, TITLE |         | DATE | PHONE |
|   |         |      |       |

**BUILDING PERMIT INSPECTION PROCEDURES**  
Please call 874-8703 (ONLY)  
or email: [buildinginspections@portlandmaine.gov](mailto:buildinginspections@portlandmaine.gov)

With the issuance of this permit, the owner, builder or their designee is required to provide adequate notice to the city of Portland Inspections Services for the following inspections. Appointments must be requested 48 to 72 hours in advance of the required inspection. The inspection date will need to be confirmed by this office.

- **Please read the conditions of approval that is attached to this permit!! Contact this office if you have any questions.**
- **Permits expire in 6 months. If the project is not started or ceases for 6 months.**
- **If the inspection requirements are not followed as stated below additional fees may be incurred due to the issuance of a "Stop Work Order" and subsequent release to continue.**

**REQUIRED INSPECTIONS:**

Final - Fire

The project cannot move to the next phase prior to the required inspection and approval to continue, REGARDLESS OF THE NOTICE OF CIRCUMSTANCES.

IF THE PERMIT REQUIRES A CERTIFICATE OF OCCUPANCY, IT MUST BE PAID FOR AND ISSUED TO THE OWNER OR DESIGNEE BEFORE THE SPACE MAY BE OCCUPIED.

**City of Portland, Maine - Building or Use Permit**

389 Congress Street, 04101 Tel: (207) 874-8703, Fax: (207) 874-8716

|                         |                                 |                     |
|-------------------------|---------------------------------|---------------------|
| Permit No:<br>201249761 | Date Applied For:<br>10/29/2012 | CBL:<br>037 H005001 |
|-------------------------|---------------------------------|---------------------|

|  |  |  |                         |
|--|--|--|-------------------------|
| Location of Construction:<br>536 CONGRESS ST | Owner Name:<br>PICKWICK PROPERTIES OF MA | Owner Address:<br>PO BOX 17502                           | Phone:                  |
| Business Name:                               | Contractor Name:<br>Norris, Inc.         | Contractor Address:<br>2257 W Broadway, PO Box 2551 Sout | Phone<br>(207) 883-3473 |
| Lessee/Buyer's Name                          | Phone:                                   | Permit Type:<br>Fire Alarm System                        |                         |

|                                       |  |
|---------------------------------------|--|
| Proposed Use:<br>Install a fire Alarm | Proposed Project Description:<br>Install a fire alarm system |
|---------------------------------------|--|

|              |                  |                           |  |
|--------------|------------------|---------------------------|--|
| Dept: Zoning | Status: Approved | Reviewer: Marge Schmuckal | Approval Date: 11/05/2012                        |
| Note:        |                  |                           | Ok to Issue: <input checked="" type="checkbox"/> |

|   |                               |                          |  |
|---|-------------------------------|--------------------------|--|
| Dept: Fire  | Status: Approved w/Conditions | Reviewer: Ben Wallace Jr | Approval Date: 12/19/2012                        |
| Note:   |                               |                          | Ok to Issue: <input checked="" type="checkbox"/> |
| <ol style="list-style-type: none"> <li>1) System acceptance and commissioning must be coordinated with alarm and suppression system contractors and the Fire Department. Call 874-8703 to schedule.</li> <li>2) Installation of a Fire Alarm system requires a Knox Box to be installed per city ordinance.</li> <li>3) The fire alarm system shall be certified by a master fire alarm company and have a new fire alarm inspection sticker.</li> <li>4) All fire alarm records required by NFPA 72 should be stored in an approved cabinet located at the FACP labeled "FIRE ALARM RECORDS".</li> <li>5) Records cabinet, FACP, annunciator(s), and pull stations shall be keyed alike.</li> <li>6) In field installation shall be installed per code as conditions dictate.</li> <li>7) Manual Pull Stations are required per NFPA 101:30.3.4.2.1 at all exit doorways and within 200 feet of travel.</li> <li>8) Fire Alarm system shall be maintained. If system is to be off line over 4 hours a fire watch shall be in place. Dispatch notification required 874-8576.</li> <li>9) Central Station monitoring for addressable fire alarm systems shall be by point.</li> <li>10 The installation shall comply with the following:<br/> City of Portland Chapter 10, Fire Prevention and Protection;<br/> NFPA 1, Fire Code (2009 edition), as amended by City Code;<br/> NFPA 101, Life Safety Code (2009 edition), as amended by City Code;<br/> City of Portland Fire Department Rules and Regulations;<br/> NFPA 72, National Fire Alarm and Signaling Code (2010 edition), as amended by Fire Department Rules and Regulations; and<br/> NFPA 70, National Electrical Code (2011 edition) as amended by the State of Maine.</li> <li>11 All smoke detectors shall be photoelectric.</li> </ol> |                               |                          |  |

2012-10-29 5



# Fire Alarm Permit

If you or the property owner owes real estate or property taxes or user charges on any property within the city, payment arrangements must be made before permits of any kind are accepted.

Installation address: 536 Congress St. CBL: 37-11-5

Exact location: (within structure) basement of 536 congress

Type of occupancy(s) (NFPA & ICC): business

Building owner: Christopher Campbell / Redwick Properties of Maine, LLC

System Designer (point of contact): Norris Inc.-- Melissa Peters

Designer phone: 883-3473 x1104 E-mail: melissap@norrisinc.com

Installing contractor: Eldee Associates Certificate of Fitness No: M1008

Contractor phone: 332-1497 E-mail: dflynn11@maine.rr.com

This is a new application: YES  NO  New AES Master Box: YES  NO   
(Include Master Box approval form)

Amendment to an existing permit: YES  NO  Permit no: \_\_\_\_\_

The following documents shall be provided with this application:

- Floor plans
- Wiring diagram
- Annunciator details
- Input/ Output Matrix
- Equipment data sheets
- Electrical Permit Pulled (check alarm/com)
- Scope of Work
- 11 1/2 x 17s
- pdf copy (may be e-mailed)
- Designer qualifications
- Battery/ voltage drop calcs

Master box approval only: YES  NO   
(If yes check *New AES Master Box* above)

COST OF WORK: 9000.00

PERMIT FEE: 110.00  
(\$10 PER \$1,000 + \$30 FOR THE FIRST \$1,000)

+ 50 Hist.

**RECEIVED**  
**OCT 29 2012**  
Dept. of Building Inspections  
CITY OF PORTLAND, MAINE

The designer shall be the responsible party for this application. Download a new copy of this application form at [www.portlandmaine.gov/fire](http://www.portlandmaine.gov/fire) for every submittal. Submit all plans in electronic PDF in addition to readable 11 1/2 x 17s to the Building Inspections Department, 389 Congress Street, Room 315, Portland, Maine 04101.

Prior to acceptance of any fire alarm system, a complete commissioning and acceptance test must be coordinated with all fire system contractors and the Fire Department, and proper documentation of such test(s) provided.

All installation(s) must comply with the *City of Portland Technical Standard for Signaling Systems for the Protection of Life and Property*, available at [www.portlandmaine.gov/fire](http://www.portlandmaine.gov/fire).

Applicant signature: [Signature] Date: 10/28/12



PO Box 2551  
2257 West Broadway  
South Portland, ME 04106

1.800.370.3473  
fax 207.879.0540

[www.norrisinc.com](http://www.norrisinc.com)

10/25/12

Scope of Work: Space Gallery—536 Congress St.

Eldee Associates to install new addressable fire alarm system per city requirements. The system will cover 3 tenant spaces—534, 536 and 538 Congress St. The panel will be located in the basement of 536 Congress St. There will be an annunciator panel at the main entrance of each tenant space along with a knock box. The building will be fully sprinkled and the sprinkler system will be monitored via a digital communicator.

Norris Inc. will provide fire alarm equipment, submittal documents, fire alarm permits, final connections and testing per City of Portland requirements.



PO Box 2551  
2257 West Broadway  
South Portland, ME 04106

1.800.370.3473  
fax 207.879.0540

[www.norrisinc.com](http://www.norrisinc.com)

# ***SUBMITTAL PACKAGE***

**Project: Space Gallery**

**System: Fire Alarm System**

**Submitted  
By: Norris Inc.  
2257 West Broadway  
South Portland, Maine 04106  
Telephone: (800) 370-3473**

**Date: October 8, 2012**



PO Box 2551  
2257 West Broadway  
South Portland, ME 04106

1.800.370.3473  
fax 207.879.0540

[www.norrisinc.com](http://www.norrisinc.com)

## Company Profile

*"We are extremely proud to represent the highest quality manufacturers integrating life safety, alarm and communication systems throughout northern New England."*

**-- Bradford Norris, President --**

## Mission Statement

Provide quality engineered systems, exceptional service.

## Goal

Learn...Continually Improve...Exceed Expectations

Founded in 1979 Norris Inc. has grown to become Northern New England's leading integrated system contracting and supply company. Norris Inc. is an innovated proactive organization with extensive experience in integration interdisciplinary building management systems. Our local and national affiliations assure that your project will be done properly regardless of size representing leading manufacturers our comprehensive products provide outstanding quality reliability and performance... surpassing customer application requirements and exceeding the stringent requirements of Underwriters Laboratories, National Fire Protection Association and other codes. We maintain an exceptional level of quality and provide the highest levels of customer service. Our knowledgeable technical support will insure the great service you deserve. Whether your needs involve industrial, commercial, institutional, or educational applications, you can trust that Norris Inc. has the complete resources it takes to provide the right solution right away.





## **OUR CONTINUOUS COMMITMENT TO OUR ENVIRONMENT**

At Norris, Inc. we are proudly committed to continuous environmental improvement for a sustainable future and to develop strong partnerships within our community.

Our mission while running our operations is to do everything within our power to improve the environmental quality of our world and to work together to create a clean and safe place to live in and work in for future generations.

We will incorporate and promote green practices within our operations with policies to support it, a system of rewarding those that fully embrace it and then will regularly review our practices for continuous improvement.

We will establish policies, make investments in technologies and set the example in our own operations to include our ongoing commitment to go paperless and making it a requirement to Reuse, Reduce & Recycle, to turn off unneeded lights, to not allow our vehicles to idle, to encourage carpooling and to utilize practical energy efficient transportation.

We will always be 100% compliant with all applicable environmental laws and regulations and will report any violations.

We will remain committed to working locally and whenever possible to sell and use locally manufactured products.

We will insist that every purchase we make will include a review of its environmental impact with a very high priority to selecting the greenest products and services available.

We will remain committed to selling low energy products. This includes promoting wireless technologies, using existing wire infrastructures in our installations, promoting solar powered devices, using our Remote Services in lieu of on-site service calls and performing calculations to minimize power supply and battery needs.

We will educate our employees and customers to illustrate that green practices and purchases are almost always less costly in the long run.

We will support and give priority to organizations that show the strongest commitment to the environment.

We will actively encourage and promote the same responsible green practices that we utilize in the work place to our employees for use in their everyday personal lives.



PO Box 2551  
2257 West Broadway  
South Portland, ME 04106

1.800.370.3473  
fax 207.879.0540

[www.norrisinc.com](http://www.norrisinc.com)

## **LIMITED WARRANTY**

Norris, Inc. warrants that the products of its manufacturers shall be free from defects in materials or workmanship as warranted by the manufacturer which is typically for a one (1) year period from the completed installation date, but not always. The completed installation date will be the date when the end-user was able to begin using or started using the product(s) or the system, whether partially or in its entirety. For projects that have a specification or bid instructions to follow which contains specific warranty requirements, Norris Inc. will always honor the warranty terms exactly as specified in the project's specifications or bid documents, which may be more or less in coverage and duration than the manufacturer's warranty. In performing hundreds of projects per year with thousands of different products it is impossible for Norris, Inc. to track the terms and details of specified or individual product warranties. Therefore Norris, Inc. will request that the owner's representative provide these special warranty details when the warranty work is requested; otherwise a standard one year warranty on the equipment will be honored. The manufacturer's warranty is for equipment only and does not include any labor and/or shipping costs. All warranties provided by Norris, Inc. are limited with the same limitations included with the manufacturer's warranty which is included in the manuals of the products being provided.

The warranty will apply only if such goods have been properly installed, are subject to normal proper use and have not been modified in any manner whatsoever. Upon return of the defective product, Norris, Inc. will, at its sole discretion, either repair or replace, at no cost, such goods determined to have a defect in materials or workmanship. In cases of a warranty repair, Norris, Inc. will use its sole discretion to determine if a suitable replacement part can be provided on loan while the repairs are being performed.

All warranty work is performed during regular business hours. If emergency warranty work is required, the customer will pay the difference between the emergency service bill and our normal hourly charges.

Norris, Inc.'s limited warranty does not apply to those products that are damaged due to misuse, abuse, negligence, exposure to adverse environmental conditions, acts of God or have been modified in any manner whatsoever.

Norris, Inc.'s Standard terms and conditions are provided with our invoices. Those Terms and Conditions shall be provided upon request.

**NORRIS, INC. SHALL NOT UNDER ANY CIRCUMSTANCES BE LIABLE FOR ANY INCIDENTAL OR CONSEQUENTIAL DAMAGES ARISING FROM LOSS OF LIFE &/OR PROPERTY OR OTHER DAMAGE OR LOSSES OWING TO THE FAILURE OF NORRIS INC. PRODUCTS BEYOND THE COST OF REPAIR OR REPLACEMENT OF ANY DEFECTIVE PRODUCTS.**

**NORRIS, INC. MAKES NO WARRANTY OF FITNESS OR MERCHANTABILITY AND NO OTHER WARRANTY, ORAL OR WRITTEN, EXPRESS OR IMPLIED AS ALLOWED TO THE FULLEST EXTENT OF THE LAW.**

**NSCA**  
BUILDING CONTRACTORS ASSOCIATION

NATIONAL SYSTEMS CONTRACTORS ASSOCIATION

# NSCA Membership Certificate

This is to certify that

**Norris Inc**

is an official member of the

**National Systems Contractors Association**

Your membership is valid through:

*January 2013*

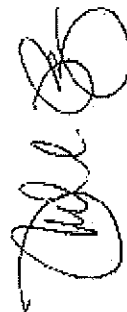

**Ron Pusey**  
President

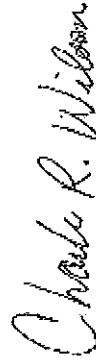

**Chuck Wilson**  
Executive Director



*NFPA recognizes:*

NORRIS INC

*as a member in good standing, entitled  
to all rights and privileges of membership.*

  
James M. Shannon, *President*

January 22, 2003  
Date of Issue

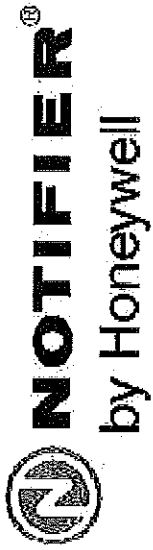

*This is to certify that*

**NORRIS, INC.**

*is an authorized Engineered Systems Distributor for NOTIFIER*

*During the year of 2012*

*Signed for and on behalf of NOTIFIER*

*Vice President Domestic Sales*

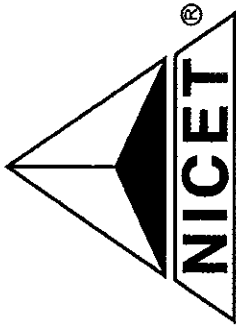

# NATIONAL INSTITUTE FOR CERTIFICATION IN ENGINEERING TECHNOLOGIES®

*Providing Certification Programs Since 1961*

BE IT KNOWN THAT

**David S. Gagnon**

IS HEREBY AWARDED CERTIFICATION AT

**LEVEL IV**

**IN FIRE PROTECTION ENGINEERING TECHNOLOGY  
FIRE ALARM SYSTEMS**

BASED UPON SUCCESSFUL DEMONSTRATION OF REQUISITE KNOWLEDGE,  
EXPERIENCE AND WORK PERFORMANCE AS SET FORTH BY THIS INSTITUTE.

Certification Valid through April 1, 2014

CERTIFICATION NUMBER 88203

CHAIRMAN OF THE NICET BOARD OF GOVERNORS

A DIVISION OF THE NATIONAL SOCIETY OF PROFESSIONAL ENGINEERS

**Norris Inc**  
2257 West Broadway  
South Portland, ME 04106  
1-800-370-3473

**310222SP**  
**Equipment List :**  
Page: 1

### Space Gallery

#### Description

NOTIFIER-NFW2-100, Addressable fire alarm control panel. Black  
ADI-IM-12180, 12V,18AH Battery  
ADI-MO-804R2, MOD TO MOD 8C 2'RADIONICS CORD  
ADI-MO-RJ31X, SFS MT 8C RJ31X UL (917UL)  
NOTIFIER-N-ANN-80, Remote LCD annunciator, Black  
NOTIFIER-NOT-BG12LX, Addressable Pull Station  
NOTIFIER-NP-100, Intelligent Addressable Photo detector, with base.  
NOTIFIER-NMM-100P, Addressable Mini Mod (sprinkler)  
NOTIFIER-HSR, Horn Strobe, Red, Wall, 2 wire, 12/24V, multi-candela  
NOTIFIER-STR, Strobe, Red, Wall, 2 wire, 12/24V, multi-candela  
Strobe Flashing, 24VDC Red -Edwards 48FINRG12  
SPAAGEELE-SSU00685, fire alarm record storage cabinet red  
SPAAGEELE-IE0091, Notifier Lock

# FireWarden-100-2(E) Rev 3

## Intelligent Addressable FACP

 **NOTIFIER**<sup>®</sup>  
by Honeywell

**Addressable Fire Alarm Control Panel**

### General

The Notifier FireWarden-100-2 Rev 3 (NFW2-100) with Version 5.0 firmware is a combination FACP (Fire Alarm Control Panel) and DACT (Digital Alarm Communicator/Transmitter) all on one circuit board. This compact intelligent addressable control panel has an extensive list of powerful features.

The SLC (Signaling Line Circuit) of the FireWarden-100-2 Rev 3 operates using a Rapid Group Polling communication protocol technology that polls multiple devices simultaneously for a quicker device response time. This patented technology allows a fully-loaded panel with up to 198 devices to report an incident and activate the notification circuits in under 10 seconds. With this improved polling, devices can be wired on standard twisted, unshielded wire up to a distance of 10,000 feet.

The quick-remove chassis protects the electronics during construction. The backbox can be installed allowing field wiring to be pulled. When construction is completed, the electronics can be quickly installed with just two bolts.

New features for Rev 3 with Version 5.0 firmware include removable terminal blocks, improved transient protection, additional secondary ANN-BUS, and increased power for the resettable and remote sync outputs.

Available accessories include ANN-BUS devices as well as ACS LED, graphic and LCD annunciators, and reverse polarity/city box transmitter.

The integral DACT transmits system status (alarms, supervises, troubles, AC loss, etc.) to a Central Station via the public switched telephone network. It also allows remote and local programming of the control panel using the PS-Tools Upload/Download utility. In addition, the control panel may be programmed or interrogated off-site via the public switched telephone network. Any personal computer with Windows® XP or greater, a compatible modem, and PS-Tools—the Upload/Download software kit—may serve as a Service Terminal. This allows download of the entire program or upload of the entire program, history file, walktest data, current status and system voltages. The panel can also be programmed through the FACP's keypad or via a standard PS-2 computer keyboard, which can be plugged directly into the printed circuit board. This permits easy typing of address labels and other programming information.

Version 5.0 firmware supports the following: Primary and Secondary ANN-bus devices, NP-A100, USB port, NAC circuit diagnostics, a new report has been added to the walk-test that lists untested devices, new device types added: audio telephone type code for NFV-25/50ZST, Photo Supervisory and auto-resettable Drill (non-latching).

The FireWatch Series internet monitoring modules IPDACT-2 and IPDACT-2UD permit monitoring of alarm signals over the Internet saving the monthly cost of two dedicated business telephone lines. Although not required, the secondary telephone line may be retained providing backup communication over the public switched telephone line.

**NOTE:** Unless otherwise specified, the term "FireWarden-100-2" is used in this document to refer to both the FireWarden-100-2 and the FireWarden-100-2E FACPs (Fire Alarm Control Panels). Likewise, "NFW2-100" refers to NFW2-100E as well.

### Features

- Listed to UL standard 864, 9th edition.
- On-board DACT.

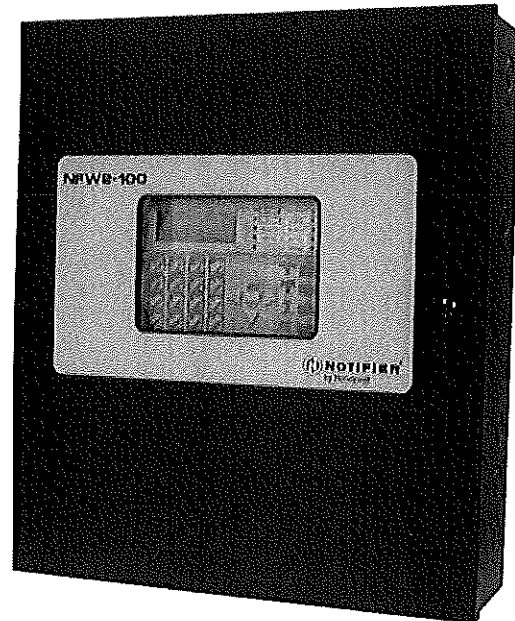

- Remote site or local USB port upload/download, using PS-Tools.
- Four (4) Style Y (Class B) NAC circuits, which can be converted to four (4) Style Z (Class A) circuits with optional ZNAC-92 converter module. (Up to 6.0 amps total NAC power when using optional XRM-24B.)
- Selectable strobe synchronization for System Sensor, Wheelock, and Gentex devices.
- Remote Acknowledge, Silence, Reset and Drill via addressable monitor modules or FDU-80, N-ANN-80 or Legacy ACS Annunciators.
- ANN-BUS for connection to following optional modules (cannot be used if ACS annunciators are used):
  - N-ANN-80(-W) Remote LCD Annunciator
  - N-ANN-I/O LED Driver
  - N-ANN-S/PG Printer Module
  - N-ANN-RLY Relay Module
  - N-ANN-LED Annunciator Module
  - N-ANN-RLED Annunciator Module alarms only
  - ROME Relay Option Module Enclosure
- ACS & Terminal-mode Annunciators:
  - ACS Annunciators: Up to 32 Legacy ACM Series annunciators (ACM-16AT or ACM-32 series). Cannot be used if ANN-BUS devices are used.
  - Terminal-mode Annunciators: Up to 32 Legacy FDU-80 annunciators.
- EIA-232 printer/PC interface (variable baud rate) on main circuit board, for use with optional UL-listed printer PRN-6.
- Integral 80-character LCD display with backlighting.
- Real-time clock/calendar with automatic daylight savings control.
- Detector sensitivity test capability (NFPA 72 compliant).



- History file with 1,000-event capacity.
- Maintenance alert warns when smoke detector dust accumulation is excessive.
- Automatic device type-code verification.
- One person audible or silent walk test with walk-test log and printout.
- Point trouble identification.
- Waterflow (nonsilenceable) selection per monitor point.
- System alarm verification selection per detector point.
- PAS (Positive Alarm Sequence) and presignal delay per point (NFPA 72 compliant).

**NOTE:** Only detectors may participate in PAS.

#### **SLC LOOP:**

- SLC can be configured for NFPA Style 4, 6, or 7 operation.
- SLC supports up to 198 addressable devices per loop (99 detectors and 99 monitor, control, or relay modules).
- SLC loop maximum length 10,000 ft. (3,000 m.).  
See *installation manual for wire tables.*

#### **NOTIFICATION APPLIANCE CIRCUITS (NACS):**

- Four onboard NACs with additional NAC capability using output control modules (NC-100). The four Class B NACs can be converted to four Class A NACs with optional ZNAC-92 converter module.
- Silence Inhibit and Auto Silence timer options.
- Continuous, March Time, Temporal or California code for main circuit board NACs with two-stage capability.
- Selectable strobe synchronization per NAC.
- 2.5 amps maximum per each NAC circuit.

**NOTE:** Maximum 24VDC system power output is shared among all NAC circuits and 24VDC special-application auxiliary power outputs. Total available output is 3.0 amps. Using the optional XRM-24B transformer increases 24VDC output to 6.0 amps.

#### **PROGRAMMING AND SOFTWARE:**

- Autoprogram (learn mode) reduces installation time.
- Custom English labels (per point) may be manually entered or selected from an internal library file.
- Three Form-C relay outputs (two programmable).
- 99 software zones.
- Continuous fire protection during online programming at the front panel.
- Program Check automatically catches common errors not linked to any zone or input point.
- **OFFLINE PROGRAMMING:** Create the entire program in your office using a Windows®-based software package (NFW2-100 requires PS-Tools Programming software, available on [www.magni-fire.com](http://www.magni-fire.com)). Upload/download system programming locally to the NFW2-100 Rev 3 in less than one minute.
- USB upload/download programming with standard Male-A to Male-B cable.

## **User Interface**

#### **LED INDICATORS**

- AC Power (green)
- Fire Alarm (red)
- Supervisory (yellow)
- Alarm Silenced (yellow)
- System Trouble (yellow)
- Maintenance/Presignal (yellow)
- Disabled (yellow)
- Battery Fault (yellow)

- Ground Fault (yellow)

#### **KEYPAD CONTROLS**

- Acknowledge/Step
- Alarm Silence
- Drill
- System Reset (lamp test)
- 16-key alpha-numeric pad (similar to telephone keypad)
- 4 cursor keys
- Enter

## **Product Line Information**

**NFW2-100:** FireWarden-100-2 Rev 3 198-point addressable Fire Alarm Control Panel, one SLC loop. Includes 80-character LCD display, single printed circuit board mounted on chassis, and cabinet. 120 VAC operation.

**NFW2-100R:** Same as NFW2-100, except in a red backbox.

**NFW2-100E:** Same as NFW2-100, except with 240 VAC operation.

**4XTM Reverse Polarity Transmitter Module:** Provides supervised output for local energy municipal box transmitter, alarm, and trouble.

**ZNAC-92:** Optional converter module which converts four (4) Style Y (Class B) NAC circuits to four (4) Style Z (Class A) circuits.

**PS Tools:** Programming software for Windows®-based PC computer (cable not included), available on [www.firelite.com](http://www.firelite.com).

**DP-9692B:** Optional dress panel for FireWarden-100-2 Rev 3.

**TR-CE-B:** Optional trim Ring for semi-flush mounting.

**BB-26:** Battery backbox, holds up to two 26 AH batteries and CHG-75.

**NFS-LBB:** Battery box, houses two 55 AH batteries.

**CHG-75:** Battery charger for lead-acid batteries with a rating of 25 to 75 AH.

**CHG-120:** Remote battery charging system for lead-acid batteries with a rating of 55 to 120 AH. Requires additional NFS-LBB for mounting.

**NOTE:** CHG-120 or CHG-75 required for batteries larger than 18AH.

**BAT Series:** Batteries, see data sheet DN-6933.

**XRM-24B(E):** Optional transformer. Increases system power output to 6.0 amps. Use XRM-24BE with FireWarden-100-2E Rev 3.

**PRT/PK-CABLE:** Cable printer/personal computer interface cable; required for printer or for local upload/download programming and updating panel firmware.

**PRN-6:** UL listed compatible event printer. Uses tractor-fed paper.

**IPDACT-2/2UD, IPDACT Internet Monitoring Module:** Mounts in bottom of enclosure with optional mounting kit (PN IPBRKT). Connects to primary and secondary DACT telephone output ports for internet communications over customer provided ethernet internet connection. Requires compatible Teldat VisorALARM Central Station Receiver. Can use DHCP or static IP. (See data sheet DN-60408 for more information.)

**IPBRKT:** Mounting kit for IPDACT-2/2UD in common enclosure.

**IPSPLT:** Y-adaptor option allows connection of both panel dialer outputs to one IPDACT-2/2UD cable input.

#### **COMPATIBLE ANNUNCIATORS**

**N-ANN-80(-W):** LCD Annunciator is a remote LCD annunciator that mimics the information displayed on the FACP LCD display. Recommended wire type is un-shielded. (Basic model is black; order -W version for white; see DN-7114.)

**N-ANN-LED:** Annunciator Module provides three LEDs for each zone: Alarm, Trouble and Supervisory. Ships with red or black enclosure (see DN-60242).

**N-ANN-RLLED:** Provides alarm (red) indicators for up to 30 input zones or addressable points. (See DN-60242).

**N-ANN-RLY:** Relay Module, which can be mounted inside the cabinet, provides 10 programmable Form-C relays. (See DN-7107.)

**ROME-B:** Relay Option Module Enclosure (order ROME-B for black or ROME for red). Provides one **N-ANN-RLY** Relay Module already installed. The ROME Series provides mounting space for one additional Relay Module or one addressable Multi-module. (See *Installation Sheet PN 53530*.)

**N-ANN-S/PG:** Serial/Parallel Printer Gateway module provides a connection for a serial or parallel printer. (See DN-7103.)

**N-ANN-I/O:** LED Driver Module provides connections to a user supplied graphic annunciator. (See DN-7105.)

**ACM-8R:** Relay module provides 8 Form-C 5.0 amp relays.

**ACM Annunciator Series:** LED-type fire annunciators capable of providing up to 99 software zones of annunciation. Available in increments of 16 or 32 points to meet a variety of applications.

**LDM Graphic Series:** Lamp Driver Module series for use with custom graphic annunciators.

**FDU-80 (Liquid Crystal Display) point annunciator:** 80-character, backlit LCD-type fire annunciators capable of displaying English-language text.

**NOTE:** For more information on *Compatible Annunciators for use with the FireWarden-100-2 Rev 3*, see the following data sheets (document numbers) **ACM-8R (DN-3558)**, **ACS/ACM Series (DN-0524)**, **LDM Series (DN-0551)**, **FDU-80 (DN-6820)**.

#### **COMPATIBLE ADDRESSABLE DEVICES**

All feature a polling LED and rotary switches for addressing.

**NI-100:** Addressable low-profile ionization smoke detector.

**NP-100:** Addressable low-profile photoelectric smoke detector.

**NP-100T:** Addressable low-profile photoelectric smoke detector with thermal sensor.

**NP-100R:** Addressable remote test capable detector for use with DNR(W) duct smoke detector housings.

**NH-100:** Fast-response, low-profile heat detector.

**NH-100R:** Fast-response, low-profile heat detector with rate-of-rise option.

**NH-100H:** Fixed high-temperature detector that activates at 190F/88C.

**NP-A100:** Addressable low-profile multi-sensor detector.

**DNR:** Innovair Flex low-flow non-relay duct-detector housing. Order NP-100R separately.

**DNRW:** Innovair Flex low-flow non-relay duct-detector housing, with NEMA-4 rating. Watertight. (Order NP-100R separately.)

**NMM-100:** Addressable Monitor Module for one zone of normally-open dry-contact initiating devices. Mounts in standard 4.0" (10.16 cm.) box. Includes plastic cover plate and end-of-line resistor. Module may be configured for either a Style B (Class B) or Style D (Class A) IDC.

**NDM-100:** Dual Monitor Module. Same as NMM-100 except it provides two Style B (Class B) only IDCs.

**NMM-100P:** Miniature version of NMM-100. Excludes LED and Style D option. Connects with wire pigtails. May mount in device backbox.

**NZM-100:** Similar to NMM-100, but may monitor up to 20 conventional two-wire detectors. Requires resettable 24 VDC power. Consult factory for compatible smoke detectors.

**NC-100:** Addressable Control Module for one Style Y/Z (Class B/A) zone of supervised polarized Notification Appliances. Mounts directly to a 4.0" (10.16 cm.) electrical box. Notification

Appliance Circuit option requires external 24 VDC to power notification appliances.

**NC-100R:** Addressable relay module containing two isolated sets of Form-C contacts, which operate as a DPDT switch. Mounts directly to a 4.0" (10.16 cm.) box, surface mount using the SMB500.

**NOT-BG12LX:** Addressable manual pull station with interface module mounted inside.

**N100-ISO:** Fault Isolator Module. This module isolates the SLC loop from short circuit conditions (required for Style 6 or 7 operation).

**SMB500:** Used to mount all modules except the NMM-100P.

**NMM-100-10:** Ten-Input monitor module. Mount one or two modules in a BB-XP cabinet (optional). Mount up to six modules on a CHS-6 chassis in a BB-25.

**NZM-100-6:** Six-zone interface module for compatible conventional two-wire detectors. Mount one or two modules in a BB-XP cabinet (optional). Mount up to six modules on a CHS-6 chassis in a BB-25.

**NOTE:** For more information on *Compatible Addressable Devices for use with the FireWarden-100-2 Rev 3*, see the following data sheets (document numbers): **N100-ISO (DN-6994)**, **NP-100 series (DN-6995)**, **NI-100 (DN-6996)**, **NH-100 series (DN-6997)**, **ND-100 series (DN-7006)**, **NP-A100 (DN-6998)**, **NMM-100/NMM-100P/NDM-100/NZM-100 (DN-6999)**, **NC-100/NC-100R (DN-7000)**, **NOT-BG12LX (DN-7001)**, **NMM-100-10 (DN-6990)**, and **NZM-100-6 (DN-60150)**.

#### **Wiring Requirements**

While shielded wire is not required, it is recommended that all SLC wiring be twisted-pair to minimize the effects of electrical interference. Wire size should be no smaller than 18 AWG (0.78 mm<sup>2</sup>) and no larger than 12 AWG (3.1 mm<sup>2</sup>). The wire size depends on the length of the SLC circuit. Refer to the panel manual for wiring details.

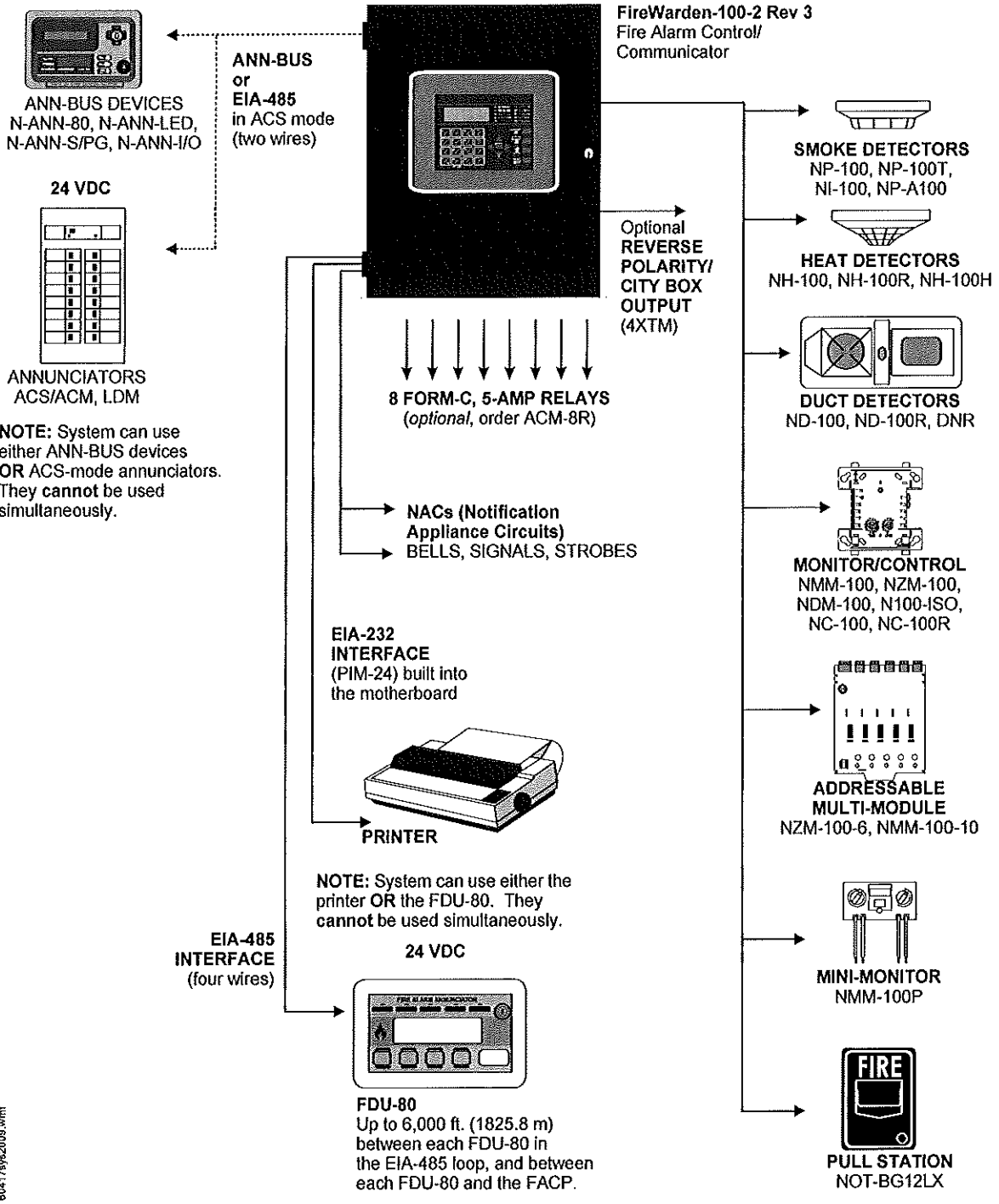

60417sys2009.wmf



# SYSTEM SPECIFICATIONS

## System Capacity

- Intelligent Signalling Line Circuits..... 1
- Addressable device capacity ..... 198
- Programmable software zones ..... 99
- ACS Annunciators ..... 32
- ANN-bus devices ..... 16

## Electrical Specifications

**AC Power:** FireWarden-100-2 Rev 3: 120 VAC, 60 Hz, 3.0 amps. FireWarden-100-2 Rev 3(E): 240 VAC, 50 Hz, 1.5 amps. Wire size: minimum 14 AWG (2.00 mm<sup>2</sup>) with 600 V insulation.

**Battery charger capacity:** 7 AH - 18 AH batteries. Up to two 18 AH batteries can be housed in the FACP cabinet. Larger batteries require an external battery charger such as the CHG-75 or CHG-120, and a separate battery cabinet such as the BB-26 or NFS-LBB.

**Communication Loop:** Supervised and power-limited.

**Notification Appliance Circuits:** Each terminal block provides connections for two Style Y (Class B) for a total of four Style Y (Class B) or with an optional ZNAC-92 module converts to four Style Z (Class A) NACs. Maximum signaling current per circuit: 2.5 amps. End-of-Line Resistor: 4.7K ohm, 1/2 watt (P/N 71252 UL listed) for Style Y (Class B) NAC. Refer to panel documentation and *Notifier Device Compatibility Document* for listed compatible devices.

**Two Programmable Relays and One Fixed Trouble Relay:** Contact rating: 2.0 amps @ 30 VDC (resistive), 0.5 amps @ 30 VAC (resistive). Form-C relays.

**Special Application Non-resettable Power (24 VDC Nominal):** Jumper selectable (JP4) for conversion to resettable power output. Up to 1.0 amp total DC current available from each output. Power-limited.

**Special Application Resettable Power (24 VDC nominal):** Jumper selectable (JP6) for conversion to non-resettable power. Up to 1.0 amp total DC current available. Refer to the *Notifier Device Compatibility Document* for listed compatible devices.

**Remote Sync Output:** Remote power supply synchronization output. Nominal special application power: 24 VDC. Maximum current: 300 mA. End-of-Line Resistor: 4.7K ohm. Output linked to NAC 1 control. Supervised and power-limited.

**Telephone Interface:** Unless used with Teldat VISORALARM, requires dedicated business telephone number with a minimum of 5 volts DC (off-hook voltage). Obtain dedicated phone line directly from your local phone company. Do not use shared phone lines or PBX (digital) type phone line extensions.

## Cabinet Specifications

**Door:** 19.26" (48.92 cm.) high x 16.82" (42.73 cm.) wide x 0.12" (.30 cm.) deep. **Backbox:** 19.00" (48.26 cm.) high x 16.65"

(42.29 cm.) wide x 5.20" (13.34 cm.) deep. **Trim Ring (TR-CE-B):** 22.00" (55.88 cm.) high x 19.65" (49.91 cm.) wide.

## Shipping Specifications

**Weight:** 26.9 lbs. (12.20 kg.) **Dimensions:** 20.00" (50.80 cm.) high x 22.5" (57.15 cm.) wide x 8.5" (21.59 cm.) deep.

## Temperature and Humidity Ranges

This system meets NFPA requirements for operation at 0 – 49°C/32 – 120°F and at a relative humidity 93% ± 2% RH (non-condensing) at 32°C ± 2°C (90°F ± 3°F). However, the useful life of the system's standby batteries and the electronic components may be adversely affected by extreme temperature ranges and humidity. Therefore, it is recommended that this system and its peripherals be installed in an environment with a normal room temperature of 15 – 27°C/60 – 80°F.

## NFPA Standards

The FireWarden-100-2 Rev 3 complies with the following NFPA 72 Fire Alarm Systems requirements:

- **LOCAL** (Automatic, Manual, Waterflow and Sprinkler Supervisory).
- **AUXILIARY** (Automatic, Manual and Waterflow) (requires 4XTM).
- **REMOTE STATION** (Automatic, Manual, Waterflow and Sprinkler Supervisory) (Where a DACT is not accepted, the alarm, trouble and supervisory relays may be connected to UL 864 listed transmitters. For reverse polarity signaling of alarm and trouble, 4XTM is required.)
- **PROPRIETARY** (Automatic, Manual, Waterflow and Sprinkler Supervisory).
- **CENTRAL STATION** (Automatic, Manual, Waterflow and Sprinkler Supervisory).
- **OT, PSDN** (Other Technologies, Packet-switched Data Network)

## Agency Listings and Approvals

The listings and approvals below apply to the basic FireWarden-100-2 Rev 3 control panel. In some cases, certain modules may not be listed by certain approval agencies, or listing may be in process. Consult factory for latest listing status.

- **UL Listed:** S635
- **FM approved**
- **CSFM:** 7165-0028:0235
- **MEA:** 120-06-E, Volume 2

For ULC-listed version, see DN-60600.

NOTIFIER® is a registered trademark of Honeywell International Inc. Wheelock® is a registered trademark of and Exceder™ is a trademark of Cooper Notification.  
©2010 by Honeywell International Inc. All rights reserved. Unauthorized use of this document is strictly prohibited.



This document is not intended to be used for installation purposes.  
We try to keep our product information up-to-date and accurate.  
We cannot cover all specific applications or anticipate all requirements.  
All specifications are subject to change without notice.



Made in the U.S.A.

# BAT Series Batteries

## Sealed Lead-Acid or Gell Cell



**Power Supplies**

### General

BAT Series Batteries feature a new part-numbering/listing system — providing an improved method of delivery for NOTIFIER-approved sealed lead-acid batteries for all your fire alarm system needs. Multiple brands of batteries are now offered under generic part numbers, reducing backorder situations and permitting us to deliver these products in a more timely fashion. NOTIFIER has approved the multiple brands listed below as possible product shipped for a given part number. Please note that any incoming orders for "PS Series" batteries will be converted to the equivalent BAT Series part numbers.

### Features

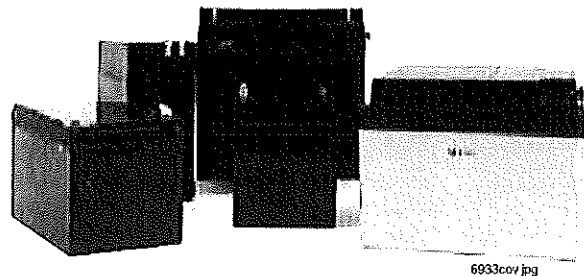
- Provide secondary power for control panels.
- Sealed and maintenance-free.
- Overcharge protected.
- Easy handling with leakproof construction.
- Ruggedly constructed, high-impact case (ABS, polystyrene, or polypropylene, depending on models).
- Long service life.
- Compact design.



6933cov.jpg

### Agency Listings and Approvals

The listings and approvals below apply to BAT Series Batteries. In some cases, certain modules may not be listed by certain approval agencies, or listing may be in process. Consult factory for latest listing status.

- **UL Recognized Components:** files MH19884 (*B & B Battery*), MH20567 (*UPG, previously Jolt*), MH20845 (*Power-Sonic*).

### Part Number Reference

| CURRENT Part Number | BATTERY DESCRIPTION      | ALTERNATES APPROVED: manufacturers and P/Ns shipped under BAT P/Ns                               |
|---------------------|--------------------------|--|
| BAT-1250            | 12 V, 5 AH, sealed.      | BP5-12 (B&B Battery); PS-1250 (Power-Sonic); SA1250 (Jolt) to be replaced with UB1250 (UPG).     |
| BAT-1250            | 12 V, 5 AH, sealed.      | BP5-12 (B&B Battery); PS-1250 (Power-Sonic); SA1250 (Jolt) to be replaced with UB1250 (UPG).     |
| BAT-1270            | 12 V, 7 AH, sealed.      | BP7-12 (B&B Battery); PS-1270 (Power-Sonic); SA1272 (Jolt) to be replaced with UB1270 (UPG).     |
| BAT-12120           | 12 V, 12 AH, sealed.     | BP12-12 (B&B Battery); PS-12120 (Power-Sonic); SA12120 (Jolt) to be replaced with UB12120 (UPG). |
| BAT-12180           | 12 V, 18 AH, sealed.     | PS-12180 (Power-Sonic); SA12180 (Jolt) to be replaced with UB12180 (UPG).                        |
| BAT-12180           | 12 V, 18 AH, sealed.     | PS-12180 (Power-Sonic); SA12180 (Jolt) to be replaced with UB12180 (UPG).                        |
| BAT-12260           | 12 V, 26 AH, sealed.     | BP26-12 (B&B Battery); PS-12260 (Power-Sonic); SA12260 (Jolt) to be replaced with UB12260 (UPG). |
| BAT-12550           | 12 V, 55 AH, sealed.     | PS-12550 (Power-Sonic); XSA12550 (Jolt) to be replaced with UB12550 (UPG).                       |
| BAT-12550           | 12 V, 55 AH, sealed.     | PS-12550 (Power-Sonic); XSA12550 (Jolt) to be replaced with UB12550 (UPG).                       |
| BAT-121000          | 12 V, 100 AH, gell cell. | PS-121000 (Power-Sonic); XSA121000A (Jolt) to be replaced with UB121000 (UPG).                   |

# POWER-SONIC

110911.tbl

## Part Number Reference

| MODEL     | Nominal Voltage V | Nominal Capacity @ 20 hr. rate A.H. | Discharge Current @20 hr. rate mA | DIMENSIONS |     |       |     |        |     |                      |     |        |      |
|-----------|-------------------|-------------------------------------|-----------------------------------|------------|-----|-------|-----|--------|-----|----------------------|-----|--------|------|
|           |                   |                                     |                                   | Width      |     | Depth |     | Height |     | Height over terminal |     | Weight |      |
|           |                   |                                     |                                   | in.        | mm  | in.   | mm  | in.    | mm  | in.                  | mm  | lb.    | kg.  |
| PS-1250   | 12                | 5                                   | 250                               | 3.54       | 90  | 2.76  | 70  | 4.02   | 102 | 4.21                 | 107 | 4.1    | 1.9  |
| PS-1270   | 12                | 7                                   | 325                               | 5.94       | 151 | 2.56  | 65  | 3.7    | 94  | 3.86                 | 98  | 5.7    | 2.6  |
| PS-12120  | 12                | 12                                  | 600                               | 5.94       | 151 | 3.86  | 98  | 3.7    | 94  | 3.86                 | 98  | 8.8    | 4    |
| PS-12180  | 12                | 18                                  | 875                               | 7.13       | 181 | 2.99  | 76  | 6.57   | 167 | 6.57                 | 167 | 12.8   | 5.8  |
| PS-12250  | 12                | 25                                  | 1300                              | 6.89       | 175 | 6.54  | 166 | 4.92   | 125 | 4.92                 | 125 | 18.7   | 8.5  |
| PS-12550  | 12                | 55                                  | 3000                              | 10.25      | 260 | 6.6   | 168 | 8.2    | 208 | 9.45                 | 240 | 39.7   | 18   |
| PS-121000 | 12                | 100                                 | 5000                              | 12         | 305 | 6.6   | 168 | 8.2    | 208 | 9.45                 | 240 | 65.7   | 29.8 |

**Characteristic Discharge Curves**

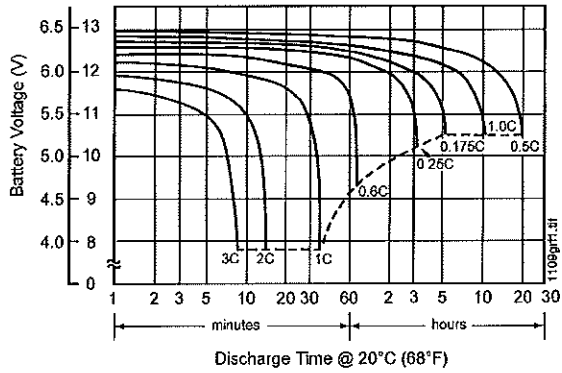

**Effect of Temperature on Capacity**

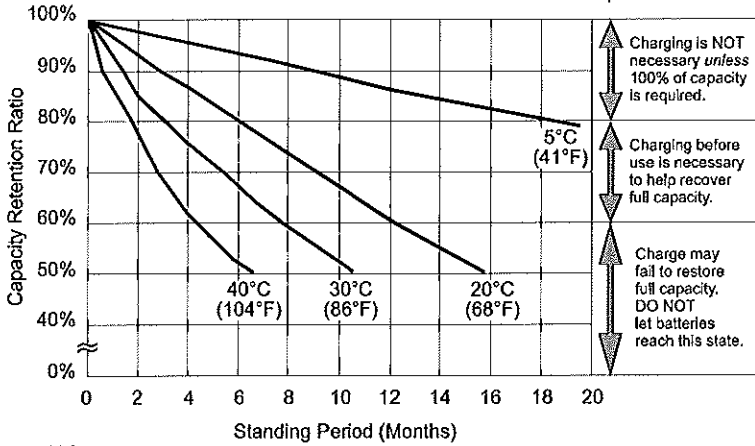
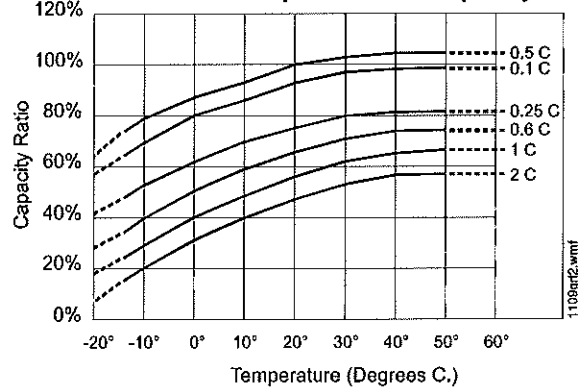

Charging is NOT necessary unless 100% of capacity is required.

Charging before use is necessary to help recover full capacity.

Charge may fail to restore full capacity. DO NOT let batteries reach this state.

at left:  
**PS-121000**  
**Shelf-Life**  
**and Storage**

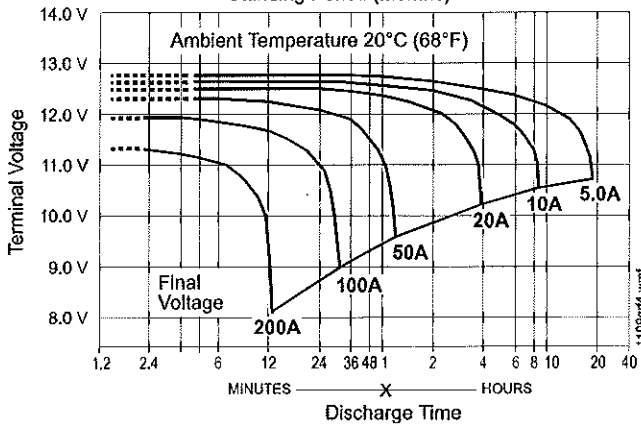

at left:  
**PS-1210000**  
**Discharge**  
**Characteristics**

## B & B BATTERY

| Model   | V  | Nominal Capacity (AH) |       |       |       | Weight |       | Terminal |      |          |      | Dimensions |      |     |      |     |      |     |      |
|---------|----|-----------------------|-------|-------|-------|--------|-------|----------|------|----------|------|------------|------|-----|------|-----|------|-----|------|
|         |    |                       |       |       |       |        |       | Standard |      | Optional |      | L          |      | W   |      | H   |      | TH  |      |
|         |    | 20 hr                 | 10 hr | 5 hr  | 1 hr  | kg     | lbs   | Type     | Pos. | Type     | Pos. | mm         | in   | mm  | in   | mm  | in   | mm  | in   |
| BP5-12  | 12 | 5.00                  | 4.75  | 4.25  | 3.00  | 1.86   | 4.10  | T1       | 3    | T2       |      | 90         | 3.54 | 70  | 2.76 | 102 | 4.02 | 106 | 4.17 |
| BP7-12  | 12 | 7.00                  | 6.65  | 5.95  | 4.20  | 2.60   | 5.73  | T2       | 5    | T1       |      | 151        | 5.94 | 65  | 2.56 | 93  | 3.66 | 98  | 3.86 |
| BP12-12 | 12 | 12.00                 | 11.40 | 10.20 | 7.20  | 4.03   | 8.89  | B1       | 5    | T1       |      | 151        | 5.94 | 98  | 3.86 | 94  | 3.70 | 98  | 3.86 |
| BP26-12 | 12 | 26.00                 | 24.70 | 22.10 | 15.60 | 9.40   | 20.73 | B1       | 7    | T2.11    | 9    | 175        | 6.89 | 166 | 6.54 | 125 | 4.92 | 125 | 4.92 |

### Charging Procedure

| Application              | Charging method   | Charging voltage at 20°C (V/cell) | Temperature compensation coefficient of charging voltage (mV/°C/cell) | Maximum charging current (CA) | Charging time 0.1 CA, 20°C (h) |               | Temp (°C)                |
|--------------------------|---|-----------------------------------|---|-------------------------------|--------------------------------|---------------|--------------------------|
|                          |   |                                   |   |                               | 100% discharge                 | 50% discharge |                          |
| For standby power source | Constant voltage and constant current charging (with current restriction) | 2.25 ~ 2.30                       | -3  | 0.3                           | 24                             | 20            | 0 ~ 40°C<br>(32 ~ 104°F) |
| For cycle service        |   | 2.40 ~ 2.50                       | -4  | 0.3                           | 16                             | 10            |                          |

Temperature compensation of charging voltage is not needed when using the batteries within 5°C to 35°C range.

| Final Voltage | Discharge Time: for Model BP5-12           |        |        |        |       |       |       |       |       |
|---------------|--|--------|--------|--------|-------|-------|-------|-------|-------|
|               | 5 min                                      | 10 min | 15 min | 30 min | 1 hr  | 3 hr  | 5 hr  | 10 hr | 20 hr |
|               | Battery Output Power (W): for Model BP5-12 |        |        |        |       |       |       |       |       |
| 10.80 V       | 180.8                                      | 133.1  | 106.6  | 63.5   | 36.39 | 14.57 | 10.05 | 5.62  | 2.94  |
| 10.50 V       | 209.2                                      | 144.2  | 111.5  | 65.9   | 37.48 | 14.87 | 10.20 | 5.70  | 3.00  |
| 10.20 V       | 222.3                                      | 149.4  | 115.0  | 67.4   | 38.16 | 15.00 | 10.26 | 5.73  | 3.01  |
| 9.90 V        | 232.3                                      | 152.9  | 117.6  | 68.3   | 38.61 | 15.10 | 10.29 | 5.75  | 3.02  |
| 9.60 V        | 240.0                                      | 156.0  | 120.0  | 69.0   | 39.0  | 15.20 | 10.32 | 5.75  | 3.02  |

**Constant Power Discharge Characteristics at 25°C/77°F for BP5-12**

| Final Voltage | Discharge Time: for Model BP7-12           |        |        |        |       |       |       |       |       |
|---------------|--|--------|--------|--------|-------|-------|-------|-------|-------|
|               | 5 min                                      | 10 min | 15 min | 30 min | 1 hr  | 3 hr  | 5 hr  | 10 hr | 20 hr |
|               | Battery Output Power (W): for Model BP7-12 |        |        |        |       |       |       |       |       |
| 10.80 V       | 253.1                                      | 186.3  | 149.3  | 88.8   | 50.95 | 20.40 | 14.07 | 7.86  | 4.11  |
| 10.50 V       | 292.9                                      | 201.8  | 156.2  | 92.2   | 52.47 | 20.81 | 14.28 | 7.98  | 4.20  |
| 10.20 V       | 311.2                                      | 209.1  | 161.0  | 94.3   | 53.42 | 21.00 | 14.36 | 8.02  | 4.22  |
| 9.90 V        | 325.2                                      | 214.1  | 164.7  | 95.6   | 54.06 | 21.15 | 14.41 | 8.04  | 4.23  |
| 9.60 V        | 336.0                                      | 218.4  | 168.0  | 96.6   | 54.60 | 21.27 | 14.45 | 8.04  | 4.23  |

**Constant Power Discharge Characteristics at 25°C/77°F for BP7-12**

| Final Voltage | Discharge Time: for Model BP12-12           |        |        |        |       |       |       |       |       |
|---------------|---|--------|--------|--------|-------|-------|-------|-------|-------|
|               | 5 min                                       | 10 min | 15 min | 30 min | 1 hr  | 3 hr  | 5 hr  | 10 hr | 20 hr |
|               | Battery Output Power (W): for Model BP12-12 |        |        |        |       |       |       |       |       |
| 10.80 V       | 433.9                                       | 319.4  | 256.0  | 152.3  | 87.34 | 34.98 | 24.12 | 13.48 | 7.05  |
| 10.50 V       | 502.2                                       | 346.0  | 267.7  | 158.1  | 89.96 | 35.68 | 24.48 | 13.68 | 7.20  |
| 10.20 V       | 533.6                                       | 358.5  | 276.0  | 161.7  | 91.57 | 36.00 | 24.61 | 13.75 | 7.23  |
| 9.90 V        | 557.5                                       | 367.1  | 282.4  | 164.0  | 92.67 | 36.25 | 24.70 | 13.79 | 7.25  |
| 9.60 V        | 576.0                                       | 374.4  | 288.0  | 165.6  | 93.60 | 36.47 | 24.77 | 13.79 | 7.25  |

**Constant Power Discharge Characteristics at 25°C/77°F for BP12-12**

| Final Voltage | Discharge Time: for Model BP26-12           |        |        |        |        |       |       |       |       |
|---------------|---|--------|--------|--------|--------|-------|-------|-------|-------|
|               | 5 min                                       | 10 min | 15 min | 30 min | 1 hr   | 3 hr  | 5 hr  | 10 hr | 20 hr |
|               | Battery Output Power (W): for Model BP26-12 |        |        |        |        |       |       |       |       |
| 10.80 V       | 940.0                                       | 692.0  | 554.6  | 330.0  | 189.23 | 75.79 | 52.25 | 29.20 | 15.26 |
| 10.50 V       | 1088.0                                      | 749.7  | 580.0  | 342.5  | 194.91 | 77.30 | 53.04 | 29.64 | 15.60 |
| 10.20 V       | 1156.0                                      | 776.7  | 598.0  | 350.3  | 198.41 | 78.00 | 53.33 | 29.79 | 15.67 |
| 9.90 V        | 1208.0                                      | 795.3  | 611.8  | 355.2  | 200.79 | 78.54 | 53.52 | 29.88 | 15.71 |
| 9.60 V        | 1248.0                                      | 811.2  | 624.0  | 358.8  | 202.80 | 79.01 | 53.68 | 29.88 | 15.71 |

**Constant Power Discharge Characteristics at 25°C/77°F for BP26-12**



# B & B BATTERY

**BP5-12 Battery Discharge Characteristics (25°C/77°F)**

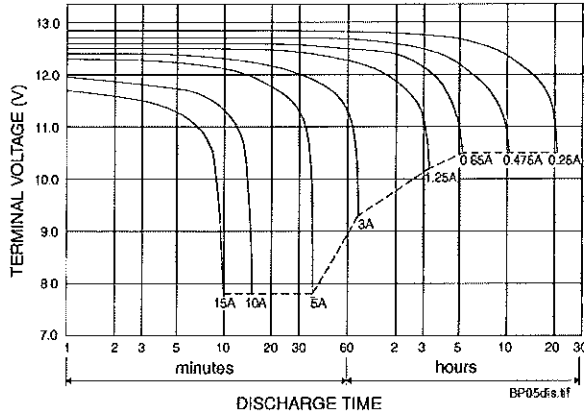

**BP7-12 Battery Discharge Characteristics (25°C/77°F)**

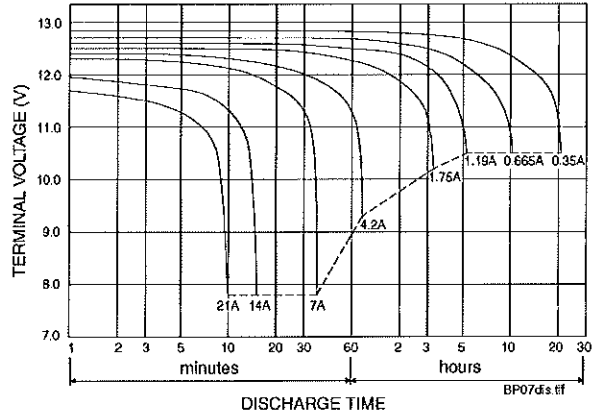

**BP12-12 Battery Discharge Characteristics (25°C/77°F)**

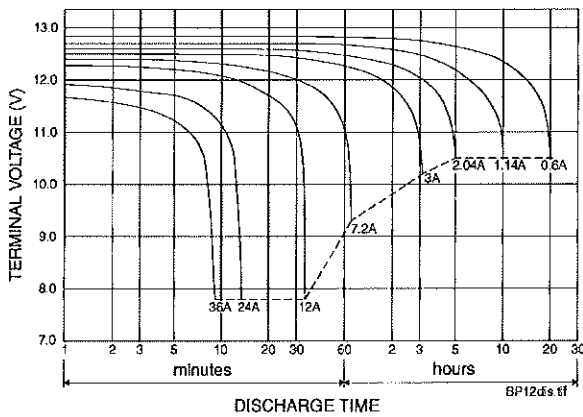

**BP26-12 Battery Discharge Characteristics (25°C/77°F)**

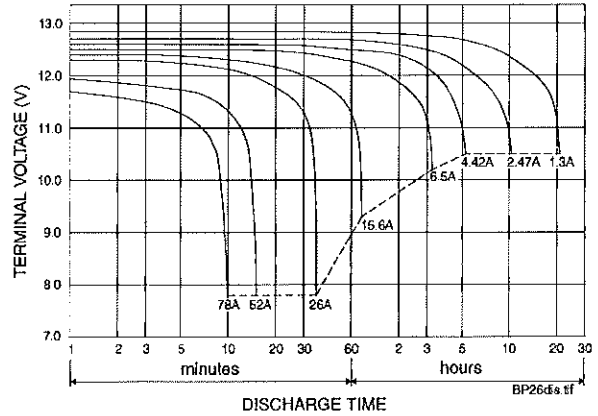

**BP05-12**



**BP12-12**

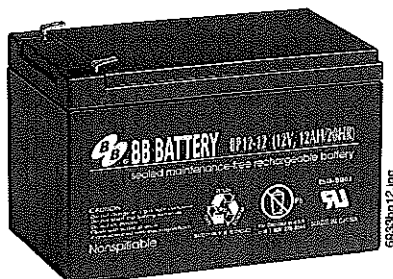

**BP26-12**



# UPG BATTERY

UB1250 has the same specifications as previous Jolt SA1250; SA1272 to be replaced with UB1270 (specs/diagrams pending).

## UB1250 (previously SA1250) Diagrams

UB1250/SA1250 discharge current vs. time

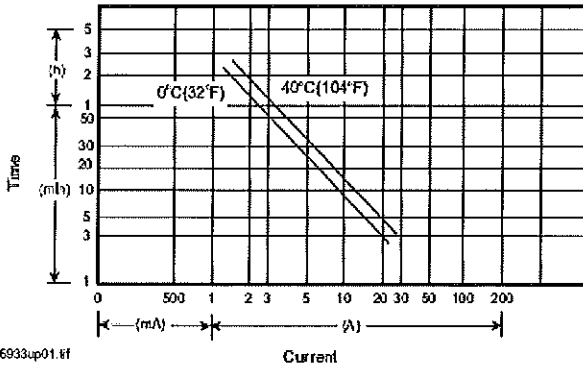

6933up01.tif

UB1250/SA1250 discharge characteristics (25°C/77°F)

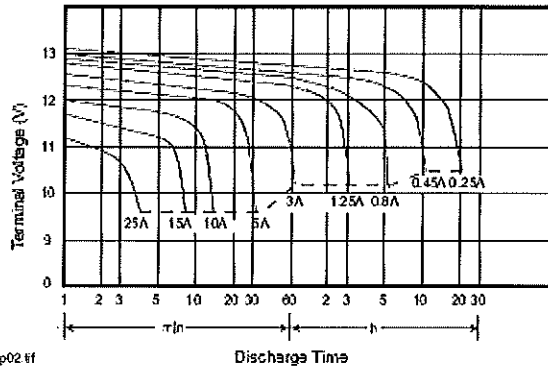

6933up02.tif

## UB1250, SA1250 Specifications

- Nominal voltage: 12 V.
- Nominal capacity (20 hr): 5.0 AH.
- Dimensions: total height 107 mm (4.21"); container height 101 mm (3.98"); length 90 mm (3.54"); width 70 mm (2.76").
- Weight: approximately 1.83 kg (4.03 lbs).
- Container material: UL94HB ABS, UL94V-0 ABS.
- Internal resistance (25°C, 77°F): ~ 32 m.
- Discharge capacity under different temperatures:
  - 40°C: ~ 102%
  - 25°C: ~ 100%
  - 0°C: ~ 85%
- Capacity 25°C/77°F:
  - 20 hr @ 0.25 A: 5.0 AH.
  - 5 hr @ 0.8 A: 4.0 AH.
  - 1 hr @ 3.0 A: 3.0 AH.
  - 1 C @ 5.0 A: 2.5 AH.
- Charging voltage (25°C, 77°F):
  - Standby use: 13.65 V ± 0.15 V.
  - Cycle use: 14.7 V ± 0.3 V.
- Maximum discharge current: 60 A (5 sec).
- Maximum charging current: 1.5 A.
- Self-discharge residual capacity (25°C, 77°F):
  - After 3 months: ~ 90%.
  - After 6 months: ~ 82%.
  - After 12 months: ~ 70%.

## SA1272 Diagrams

SA1272 discharge current vs. time

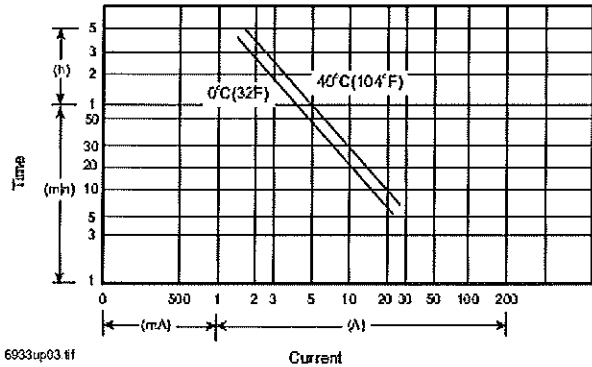

6933up03.tif

SA1272 discharge characteristics (25°C/77°F)

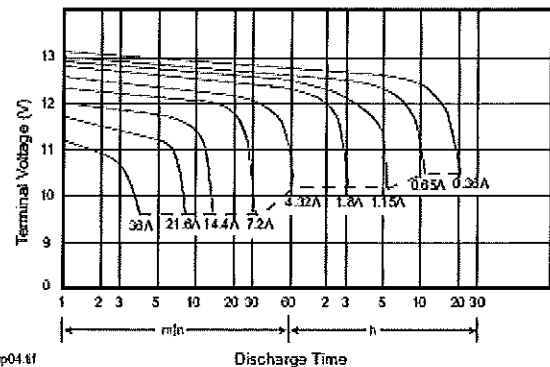

6933up04.tif

## SA1272 Specifications

- Nominal voltage: 12 V.
- Nominal capacity (20 hr): 7.2 AH.
- Dimensions: total height 100 mm (3.94"); container height 94 mm (3.70"); length 151 mm (5.95"); width 65 mm (2.56").
- Weight: approximately 2.66 kg (5.85 lbs).
- Container material: UL94HB ABS, UL94V-0 ABS.
- Internal resistance (25°C, 77°F): ~ 22 m.
- Discharge capacity under different temperatures:
  - 40°C: ~ 102%
  - 25°C: ~ 100%
  - 0°C: ~ 85%
- Capacity 25°C/77°F:
  - 20 hr @ 0.36 A: 7.2 AH.
  - 5 hr @ 1.15 A: 5.76 AH.
  - 1 hr @ 4.32 A: 4.32 AH.
  - 1 C @ 7.2 A: 3.6 AH.
- Charging voltage (25°C, 77°F):
  - Standby use: 13.65 V ± 0.15 V.
  - Cycle use: 14.7 V ± 0.3 V.
- Maximum discharge current: 90 A (5 sec).
- Maximum charging current: 2.16 A.
- Self-discharge residual capacity (25°C, 77°F):
  - After 3 months: ~ 90%.
  - After 6 months: ~ 82%.
  - After 12 months: ~ 70%.

# UPG BATTERY

Same specifications as previous Jolt models; packaging and part numbers are the only changes.

## UB12120 (was SA12120) Diagrams

UB12120/SA12120 discharge current vs. time

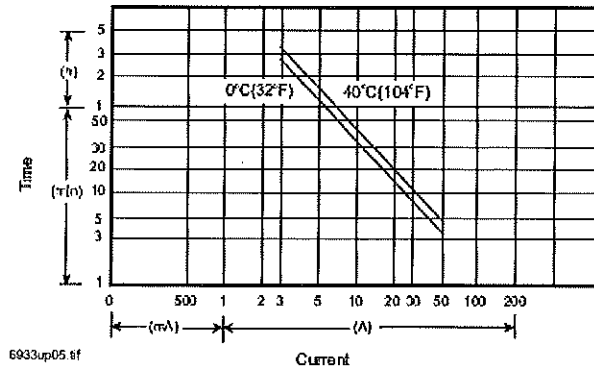

UB12120/SA12120 discharge characteristics (25°C/77°F)

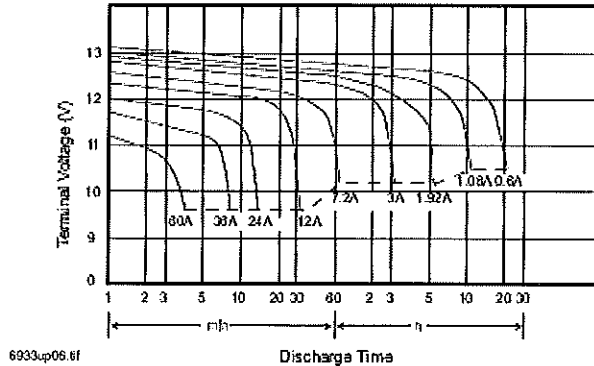

## UB12180 (was SA12180) Diagrams

UB12180/SA12180 discharge current vs. time

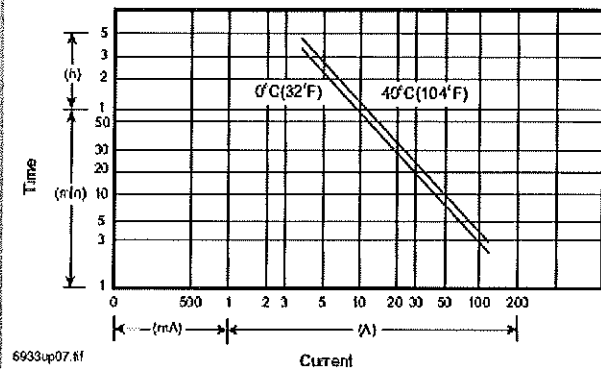

UB12180/SA12180 discharge characteristics (25°C/77°F)

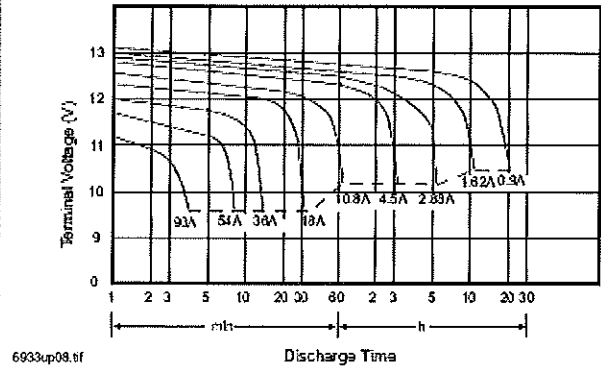

## UB12120, SA12120 Specifications

- Nominal voltage: 12 V.
  - Nominal capacity (20 hr): 12.0 AH.
  - Dimensions: total height 100 mm (3.94"); container height 94 mm (3.70"); length 151 mm (5.95"); width 98 mm (3.86").
  - Weight: approximately 4.10 kg (9.04 lbs).
  - Container material: UL94HB ABS, UL94V-0 ABS.
  - Internal resistance (25°C, 77°F): ~ 14 m.
  - Discharge capacity under different temperatures:
    - 40°C: ~ 102%
    - 25°C: ~ 100%
    - 0°C: ~ 85%
  - Capacity 25°C/77°F:
    - 20 hr @ 0.6 A: 12.0 AH.
    - 5 hr @ 1.92 A: 9.6 AH.
    - 1 hr @ 7.2 A: 7.2 AH.
    - 1 C @ 12.0 A: 6.0 AH.
  - Charging voltage (25°C, 77°F):
    - Standby use: 13.65 V ± 0.15 V.
    - Cycle use: 14.7 V ± 0.3 V.
- Maximum discharge current: 120 A (5 sec).  
 Maximum charging current: 3.6 A.  
 Self-discharge residual capacity (25°C, 77°F):  
 After 3 months: ~ 90%.  
 After 6 months: ~ 82%.  
 After 12 months: ~ 70%.

## UB12180, SA12180 Specifications

- Nominal voltage: 12 V.
  - Nominal capacity (20 hr): 18.0 AH.
  - Dimensions: total height 167 mm (6.58"); container height 167 mm (6.58"); length 181 mm (7.13"); width 76 mm (2.99").
  - Weight: approximately 6.06 kg (13.36 lbs).
  - Container material: UL94HB ABS, UL94V-0 ABS.
  - Internal resistance (25°C, 77°F): ~ 13 m.
  - Discharge capacity under different temperatures:
    - 40°C: ~ 102%
    - 25°C: ~ 100%
    - 0°C: ~ 85%
  - Capacity 25°C/77°F:
    - 20 hr @ 0.9 A: 18.0 AH.
    - 5 hr @ 2.88 A: 14.4 AH.
    - 1 hr @ 10.8 A: 10.8 AH.
    - 1 C @ 18.0 A: 9.0 AH.
  - Charging voltage (25°C, 77°F):
    - Standby use: 13.65 V ± 0.15 V.
    - Cycle use: 14.7 V ± 0.3 V.
- Maximum discharge current: 300 A (5 sec).  
 Maximum charging current: 5.4 A.  
 Self-discharge residual capacity (25°C, 77°F):  
 After 3 months: ~ 90%.  
 After 6 months: ~ 82%.  
 After 12 months: ~ 70%.

# UPG BATTERY

Same specifications as previous Jolt models;  
packaging and part numbers are the only changes.

## UB12260 (was SA12260) Diagrams

UB12260/SA12260 discharge current vs. time

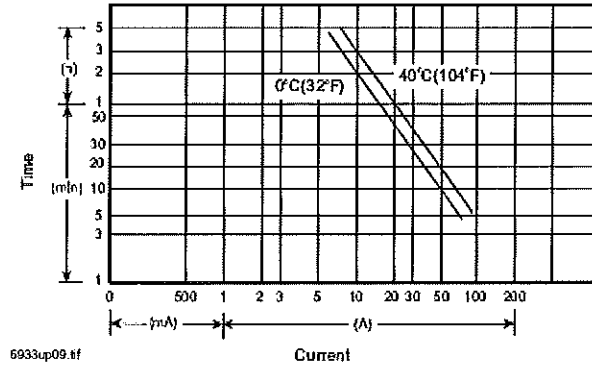

6933up09.tif

UB12260/SA12260 discharge characteristics (25°C/77°F)

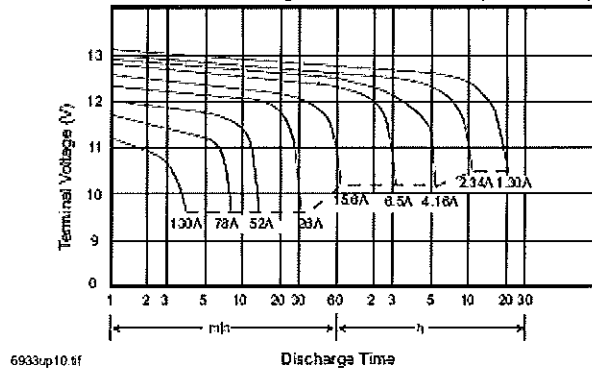

6933up10.tif

## UB12260, SA12260 Specifications

- Nominal voltage: 12 V.
- Nominal capacity (20 hr): 26.0 AH.
- Dimensions: total height 125 mm (4.92"); container height 125 mm (4.92"); length 166 mm (6.54"); width 175 mm (6.89").
- Weight: approximately 8.80 kg (19.40 lbs).
- Container material: UL94HB ABS, UL94V-0 ABS.
- Internal resistance (25°C, 77°F): ~ 10 m.
- Discharge capacity under different temperatures:
  - 40°C: ~ 102%
  - 25°C: ~ 100%
  - 0°C: ~ 85%
- Capacity 25°C/77°F:
  - 20 hr @ 1.3 A: 26.0 AH.
  - 5 hr @ 4.16 A: 20.8 AH.
  - 1 hr @ 15.6 A: 15.6 AH.
  - 1 C @ 26.0 A: 13.0 AH.
- Charging voltage (25°C, 77°F):
  - Standby use: 13.65 V ± 0.15 V.
  - Cycle use: 14.7 V ± 0.3 V.
- Maximum discharge current: 300 A (5 sec).
- Maximum charging current: 7.8 A.
- Self-discharge residual capacity (25°C, 77°F):
  - After 3 months: ~ 90%.
  - After 6 months: ~ 82%.
  - After 12 months: ~ 70%.

## UB12550 (was SA12550) Diagrams

UB12550/SA12550 discharge current vs. time

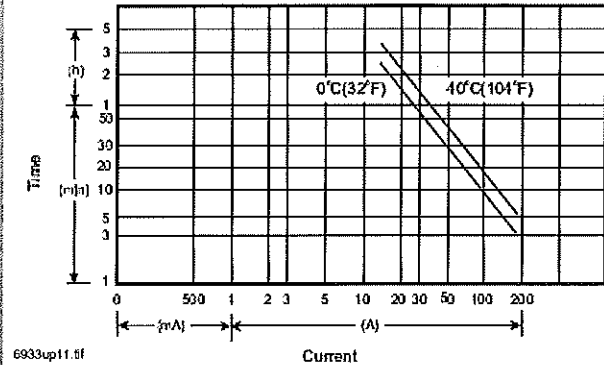

6933up11.tif

UB12550/SA12550 discharge characteristics (25°C/77°F)

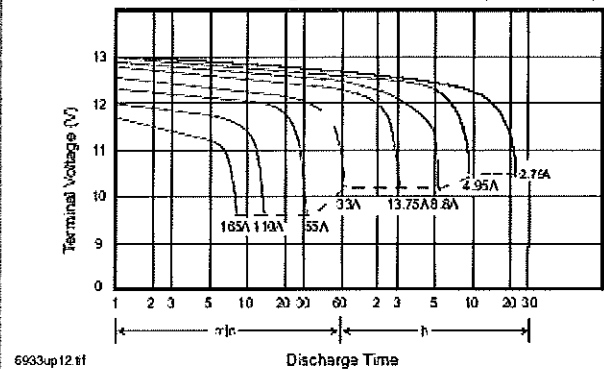

6933up12.tif

## UB12550, SA12550 Specifications

- Nominal voltage: 12 V.
- Nominal capacity (20 hr): 55.0 AH.
- Dimensions: total height 234.5 mm (9.23"); container height 216.5 mm (8.52"); length 229 mm (9.02"); width 138 mm (5.43").
- Weight: approximately 19.0 kg (41.8 lbs).
- Container material: UL94HB ABS, UL94V-0 ABS.
- Internal resistance (25°C, 77°F): ~ 8 m.
- Discharge capacity under different temperatures:
  - 40°C: ~ 102%
  - 25°C: ~ 100%
  - 0°C: ~ 85%
- Capacity 25°C/77°F:
  - 20 hr @ 2.75 A: 55.0 AH.
  - 5 hr @ 8.8 A: 44.0 AH.
  - 1 hr @ 33.0 A: 33.0 AH.
  - 1 C @ 55.0 A: 27.5 AH.
- Charging voltage (25°C, 77°F):
  - Standby use: 13.65 V ± 0.15 V.
  - Cycle use: 14.7 V ± 0.3 V.
- Maximum discharge current: 600 A (5 sec).
- Maximum charging current: 16.5 A.
- Self-discharge residual capacity (25°C, 77°F):
  - After 3 months: ~ 90%.
  - After 6 months: ~ 82%.
  - After 12 months: ~ 70%.

# UPG BATTERY

Same specifications as previous Jolt models; packaging and part numbers are the only changes.

## UB121000 (XSA121000A) Diagrams

UB121000/XSA121000A discharge current vs. time

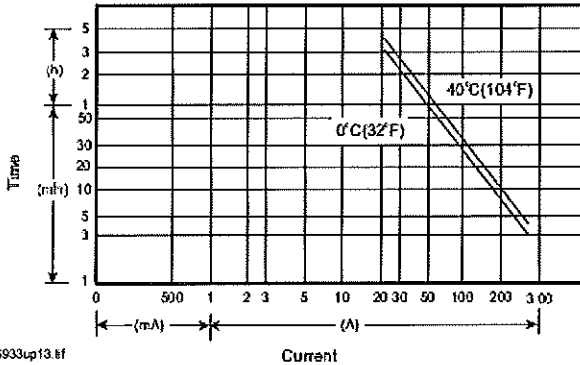

UB121000/XSA121000A discharge characteristics (25°C/77°F)

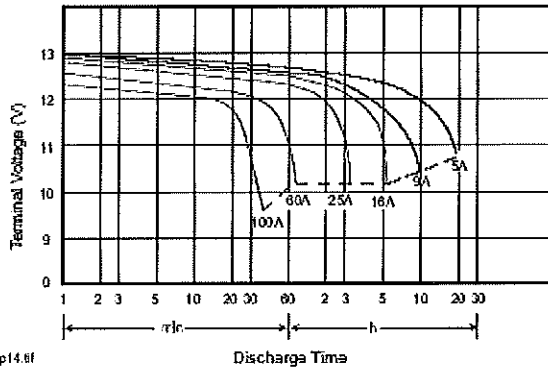

## UB121000 (XSA121000A) Diagrams

- Nominal voltage: 12 V.
- Nominal capacity (20 hr): 100.0 AH.
- Dimensions: total height 221 mm (8.70"); container height 214 mm (8.43"); length 329 mm (12.95"); width 172 mm (6.77").
- Weight: approximately 34.00 kg (74.8 lbs).
- Container material: UL94HB ABS, UL94V-0 ABS.
- Internal resistance (25°C, 77°F): ~ 6.5 m.
- Discharge capacity under different temperatures:
  - 40°C: ~ 102%
  - 25°C: ~ 100%
  - 0°C: ~ 85%
- Capacity 25°C/77°F:
  - 20 hr @ 5.0 A: 100.0 AH.
  - 5 hr @ 16.0 A: 80.0 AH.
  - 1 hr @ 60.0 A: 60.0 AH.
  - 1 C @ 100.0 A: 50.0 AH.
- Charging voltage (25°C, 77°F):
  - Standby use: 13.65 V ± 0.15 V.
  - Cycle use: 14.7 V ± 0.3 V.
- Maximum discharge current: 600 A (5 sec).
- Maximum charging current: 30 A.
- Self-discharge residual capacity (25°C, 77°F):
  - After 3 months: ~ 90%.
  - After 6 months: ~ 82%.
  - After 12 months: ~ 70%.

## UPG Summary Diagrams

Summary discharge characteristics

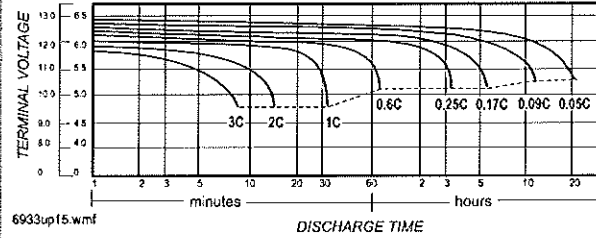

Summary discharge current vs. time curve (25°C/77°F)

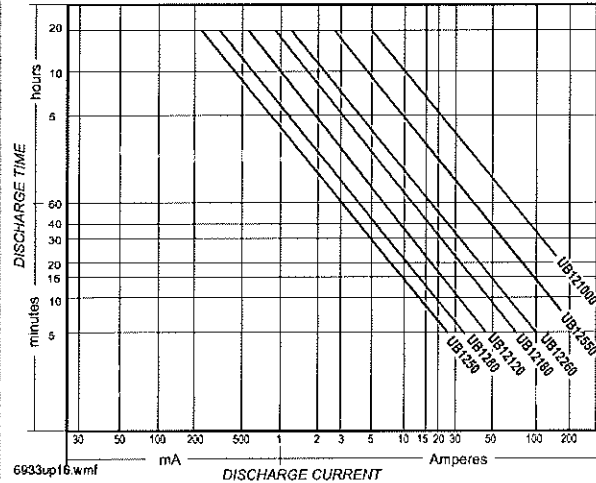

## UPG BATTERY

Same specifications as previous Jolt models;  
packaging and part numbers are the only changes.

### Charging Procedure: UPG Battery

| Application              | Charging method   | Charging voltage at 25°C (V/cell) | Temperature compensation coefficient of charging voltage (mV/°C/cell) | Maximum charging current (CA) | Charging time 0.1 CA, 25°C (h) |                   | Temp (°C)                |
|--------------------------|---|-----------------------------------|---|-------------------------------|--------------------------------|-------------------|--------------------------|
|                          |   |                                   |   |                               | 100% discharge                 | 50% discharge     |                          |
| For standby power source | Constant voltage and constant current charging (with current restriction) | 2.25 ~ 2.30                       | -3.3<br>(-1.8 mV/°F/cell)   | 0.3                           | T <sup>3</sup> 24              | T <sup>3</sup> 20 | 0 - 40°C<br>(32 - 104°F) |
| For cycle service        |   | 2.40 ~ 2.50                       | -5<br>(-2.8 mV/°F/cell)   | 0.3                           | 16 < T < 24                    | 10 < T < 24       |                          |

Temperature compensation of charging voltage is not needed when using the batteries within 5°C to 35°C range.

---

**NOTIFIER®** is a registered trademark of Honeywell International Inc.  
Batteries display trademarks of the manufacturer.  
©2009 by Honeywell International Inc. All rights reserved. Unauthorized use  
of this document is strictly prohibited.

---



This document is not intended to be used for installation purposes.  
We try to keep our product information up-to-date and accurate.  
We cannot cover all specific applications or anticipate all requirements.  
All specifications are subject to change without notice.

# N-ANN-80

## 80-Character LCD Serial Annunciator

 **NOTIFIER**<sup>®</sup>  
by Honeywell

**Annunciators**

### General

The N-ANN-80 annunciator is a compact, backlit, 80-character LCD fire annunciator that mimics the Fire Alarm Control Panel (FACP) display. It provides system status indicators for AC Power, Alarm, Trouble, Supervisory, and Alarm Silenced conditions. The N-ANN-80 and the FACP communicate over a two-wire serial interface employing the ANN-BUS communication format. Connected devices are powered, via two additional wires, by either the host FACP or a remote UL-listed, filtered power supply. N-ANN-80 is black; for white order N-ANN-80-W.

The N-ANN-80 displays English-language text of system point information including device type, zone, independent point alarm, trouble or supervisory status, as well as any custom alpha labels programmed into the control panel. It includes control switches for remote control of critical system functions. (A keyswitch prevents unauthorized operation of the control switches.)

Up to eight N-ANN-80s may be connected to the ANN-BUS of each FACP. Minimal programming is required, which saves time during system commissioning. The N-ANN-80 is compatible with NOTIFIER FACPs with an ANN-BUS, such as the NFW-50.

### Features

- Listed to UL Standard 864, 9th Edition.
- Backlit 80-character LCD display (20 characters x 4 lines).
- Mimics all display information from the host panel.
- Control switches for System Acknowledge, Signal Silence, Drill, and Reset.
- Control switches can be independently enabled or disabled at the FACP.
- Keyswitch enables/disables control switches and mechanically locks annunciator enclosure
- Keyswitch can be enabled or disabled at the FACP.
- Enclosure supervised for tamper.
- System status LEDs for AC Power, Alarm, Trouble, Supervisory, and Alarm Silence.
- Local sounder can be enabled or disabled at the FACP.
- N-ANN-80 connects to the ANN-BUS terminal on the FACP and requires minimal panel programming.
- Displays device type identifiers, individual point alarm, trouble, supervisory, zone, and custom alpha labels.
- Time-and date display field.
- Surface mount directly to wall or to single, double, or 4" square electrical box.
- Semi-flush mount to single, double, or 4" square electrical box. Use ANN-SB80KIT for angled view mounting.
- Can be remotely located up to 6,000 feet (1,800 m) from the panel.
- Backlight turns off during AC loss to conserve battery power but will turn back on if an alarm condition occurs.
- May be powered by 24 VDC from the host FACP or by remote power supply (requires 24 VDC).
- Up to eight N-ANN-80s can be connected on the ANN-BUS.

### Controls and Indicators

- AC Power
- Alarm



7114cqv.jpg

- Trouble
- Supervisory
- Alarm Silenced

### Specifications

- **Operating voltage range:** 18 VDC to 28 VDC.
- **Current consumption @ 24 VDC nominal (filtered and non-resettable):** 40 mA maximum.
- **Ambient temperature:** 32°F to 120°F (0°C to 49°C).
- **Relative humidity:** 93% ± 2% RH (noncondensing) at 32°C ± 2°C (90°F ± 3°F).
- 5.375" (13.65 cm.) high x 6.875" (17.46 cm.) wide x 1.375" (3.49 cm.) deep.
- For use indoors in a dry location.
- All connections are power-limited and supervised.

### Agency Listings and Approvals

The listings and approvals below apply to the N-ANN-80. In some cases, certain modules may not be listed by certain approval agencies, or listing may be in process. Consult factory for latest listing status.

- **UL:** S635
- **FM approved**
- **CSFM:** 7120-0028:240
- **MEA:** 442-06-E Vol. 2

### The ANN-BUS

#### POWERING THE DEVICES ON THE ANN-BUS FROM AUXILIARY POWER SUPPLY

The ANN-BUS can be powered by an auxiliary power supply when the maximum number of ANN-BUS devices exceeds the ANN-BUS power requirements. See the FACP manual for more information.



### ANN-BUS DEVICE ADDRESSING

Each ANN-BUS device requires a unique address (ID Number) in order to communicate with the FACP. A maximum of 8 devices can be connected to the FACP ANN-BUS communication circuit. See the FACP manual for more information.

### WIRE REQUIREMENTS: COMMUNICATIONS CIRCUIT

The N-ANN-80 connects to the FACP ANN-BUS communications circuit. To determine the type of wire and the maximum wiring distance that can be used with FACP ANN-BUS accessory modules, it is necessary to calculate the total worst case current draw for all modules on a single 4-conductor bus. The total worst case current draw is calculated by adding the individual worst case currents for each module.

**NOTE:** For total worst case current draw on a single ANN-BUS refer to appropriate FACP manual.

After calculating the total worst case current draw, the following table specifies the maximum distance the modules can be located from the FACP on a single wire run. The table ensures 6.0 volts of line drop maximum. In general, the wire length is limited by resistance, but for heavier wire gauges, capacitance is the limiting factor.

These cases are marked in the chart with an asterisk (\*). Maximum length can never be more than 6,000 feet (1,800 m), regardless of gauge used. See table below.

### WIRE REQUIREMENTS: POWER CIRCUIT

- 14 to 18 AWG (0.75 - 2.08 mm<sup>2</sup>) wire for 24 VDC power circuit is acceptable.
- All connections are power-limited and supervised.
- A maximum of eight N-ANN-80 modules may be connected to this circuit.

| Communication Pair Wiring Distance: FACP to Last ANN-BUS Module |           |           |             |            |
|---|-----------|-----------|-------------|------------|
| Total Worst Case Current Draw (amps)                            | 22 Gauge  | 18 Gauge  | 16 Gauge    | 14 Gauge   |
| 0.100   | 1,852 ft. | 4,688 ft. | * 6,000 ft. | *6,000 ft. |
| 0.200   | 926 ft.   | 2,344 ft. | 3,731 ft.   | 5,906 ft.  |
| 0.300   | 617 ft.   | 1,563 ft. | 2,488 ft.   | 3,937 ft.  |
| 0.400   | 463 ft.   | 1,172 ft. | 1,866 ft.   | 2,953 ft.  |
| 0.500   | 370 ft.   | 938 ft.   | 1,493 ft.   | 2,362 ft.  |
| 0.600   | 309 ft.   | 781 ft.   | 1,244 ft.   | 1,969 ft.  |
| 0.700   | 265 ft.   | 670 ft.   | 1,066 ft.   | 1,687 ft.  |
| 0.800   | 231 ft.   | 586 ft.   | 933 ft.     | 1,476 ft.  |
| 0.900   | 206 ft.   | 521 ft.   | 829 ft.     | 1,312 ft.  |
| 1.000 (max.)  | 185 ft.   | 469 ft.   | 746 ft.     | 1,181 ft.  |

### WIRING CONFIGURATION

The following figure illustrates the wiring between the FACP and ANN-BUS devices.

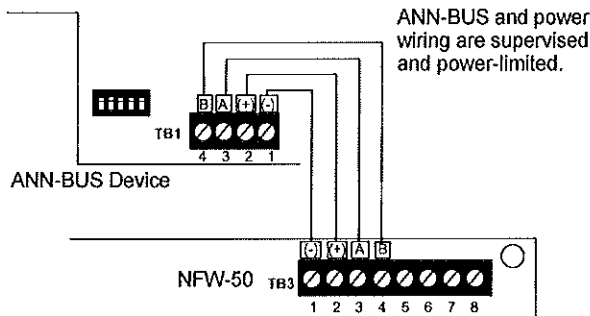

FACP Wiring to ANN-BUS Device

### ORDERING OPTIONS:

- N-ANN-80:** Black 80 character LCD Annunciator.
- N-ANN-80-W:** White, 80 character LCD Annunciator.
- ANN-SB80KIT-B:** Black surface mount backbox with angled wedge.
- ANN-SB80KIT-W:** White surface mount backbox with angled wedge.

©2009 by Honeywell International Inc. All rights reserved. Unauthorized use of this document is strictly prohibited.



This document is not intended to be used for installation purposes. We try to keep our product information up-to-date and accurate. We cannot cover all specific applications or anticipate all requirements. All specifications are subject to change without notice.



Made in the U.S. A.

# NOT-BG12LX

## Addressable Manual Pull Station For FireWarden Series Panels



Intelligent/Addressable Devices

### General

The Notifier NOT-BG12LX is a state-of-the-art, dual-action (i.e., requires two motions to activate the station) pull station that includes an addressable interface for FireWarden series intelligent control panels, and the NSP-25 panel. Because the NOT-BG12LX is addressable, the control panel can display the exact location of the activated manual station. This leads fire personnel quickly to the location of the alarm.

### Features

- Maintenance personnel can open station for inspection and address setting without causing an alarm condition.
- Built-in bicolor LED, which is visible through the handle of the station, flashes in normal operation and latches steady red when in alarm.
- Handle latches in down position and the word "ACTIVATED" appears to clearly indicate the station has been operated.
- Captive screw terminals wire-ready for easy connection to SLC loop (accepts up to 12 AWG/3.25 mm<sup>2</sup> wire).
- Can be surface mounted (with SB-10 or SB-I/O) or semi-flush mounted. Semi-flush mount to a standard single-gang, double-gang, or 4" (10.16 cm) square electrical box.
- Smooth dual-action design.
- Meets ADAAG controls and operating mechanisms guidelines (Section 4.1.3[13]); meets ADA requirement for 5 lb. maximum activation force.
- Highly visible.
- Attractive shape and textured finish.
- Key reset.
- Includes Braille text on station handle.
- Optional trim ring (BG12TR).
- Meets UL 38, Standard for Manually Actuated Signaling Boxes.

### Construction

Shell, door, and handle are molded of durable polycarbonate material with a textured finish.

### Specifications

- **Shipping Weight:** 9.6 oz. (272.15 g)
- **Normal operating voltage:** 24 VDC.
- **Maximum SLC loop voltage:** 28.0 VDC.
- **Maximum SLC loop current:**  $\mu$ A.
- **Temperature Range:** 32°F to 120°F (0°C to 49°C)
- **Relative Humidity:** 10% to 93% (noncondensing)
- **For use indoors in a dry location**

### Installation

The NOT-BG12LX will mount semi-flush into a single-gang, double-gang, or standard 4" (10.16 cm) square electrical outlet box, or will surface mount to the model SB-10 or SB-I/O surface backbox. If the NOT-BG12LX is being semi-flush mounted, then the optional trim ring (BG12TR) may be used.



The NOT-BG12LX  
Addressable Manual Pull Station

The BG12TR is usually needed for semi-flush mounting with 4" (10.16 cm) or double-gang boxes (not with single-gang boxes).

### Operation

Pushing in, then pulling down on the handle causes it to latch in the down/activated position. Once latched, the word "ACTIVATED" (in bright yellow) appears at the top of the handle, while a portion of the handle protrudes from the bottom of the station. To reset the station, simply unlock the station with the key and pull the door open. This action resets the handle; closing the door automatically resets the switch.

Each manual station, on command from the control panel, sends data to the panel representing the state of the manual switch. Two rotary decimal switches allow address settings (1 - 99 on NFW2-100/NFW2-100C, 1 - 50 for NFW-50/NFW-50C).

### Architectural/Engineering Specifications

Manual Fire Alarm Stations shall be non-coded, with a key-operated reset lock in order that they may be tested, and so designed that after actual Emergency Operation, they cannot be restored to normal except by use of a key. An operated station shall automatically condition itself so as to be visually detected as activated. Manual stations shall be constructed of red-colored polycarbonate material with clearly visible operating instructions provided on the cover. The word FIRE shall appear on the front of the stations in white letters, 1.00 inches (2.54 cm) or larger. Stations shall be suitable for surface mounting on matching backbox SB-10 or SB-I/O; or semi-flush mounting on a standard single-gang, double-gang, or 4" (10.16 cm) square electrical box, and shall be installed within

the limits defined by the Americans with Disabilities Act (ADA) or per national/local requirements. Manual Stations shall be Underwriters Laboratories listed.

Manual stations shall connect with two wires to one of the control panel SLC loops. The manual station shall, on command from the control panel, send data to the panel representing the state of the manual switch. Manual stations shall provide address setting by use of rotary decimal switches.

### Product Line Information

**NOT-BG12LX:** Dual-action addressable pull station. Includes key locking feature.

**NOT-BG12LXA:** *Canadian* Dual-action addressable pull station. Includes key locking feature.

**SB-10:** Surface backbox; metal.

**SB-I/O:** Surface backbox; plastic.

**BG12TR:** Optional trim ring.

**17021:** Keys, set of two.

### Agency Listings and Approvals

In some cases, certain modules or applications may not be listed by certain approval agencies, or listing may be in process. Consult factory for latest listing status.

- **UL Listed:** S692 (listed for Canadian and non-Canadian applications)
- **MEA:** 67-02-E Vol. IV
- **CSFM:** 7150-0028:0199
- **FDNY:**
- **FM Approved**

**Patented:** U.S. Patent No. D428,351; 6,380,846; 6,314,772; 6,632,108.

---

Notifier® is a registered trademark of Honeywell International Inc.  
©2010 by Honeywell International Inc. All rights reserved. Unauthorized use of this document is strictly prohibited.

---



This document is not intended to be used for installation purposes.  
We try to keep our product information up-to-date and accurate.  
We cannot cover all specific applications or anticipate all requirements.  
All specifications are subject to change without notice.



Made in the U.S. A.

# NP-100(A), NP-100T(A), NP-100R(A)

dn-6995:b • A1-320

## Addressable Photoelectric Detectors for the FireWarden Series



Addressable

### General

The NP-100 and NP-100T addressable, low-profile plug-in photoelectric detectors use a state-of-the-art photoelectric sensing chamber with communications to provide open area protection and are used exclusively with NOTIFIER's FireWarden Series (FireWarden-100-2 and FireWarden-50) Addressable Fire Alarm Control Panels (FACPs). The NP-100T adds thermal sensors that will alarm at a fixed temperature of 135°F (57°C). Since these detectors are addressable, they will help emergency personnel quickly locate a fire during its early stages, potentially saving precious rescue time while also reducing property damage. Two LEDs on each sensor light to provide a local, visible sensor indication. Remote LED annunciator capability is available as an optional accessory (P/N RA100Z(A)). The NP-100R is a remote test capable detector for use with DNR(W) duct smoke detector housings.

### Features

#### SLC loop:

- Two-wire loop connection.
- Unit uses base for wiring.

#### Addressing:

- Addressable by device.
- Direct Decode entry of address: 01 – 99 with FireWarden-100-2, and 01 – 50 with FireWarden-50.

#### Architecture:

- Unique single-source, dual-chamber design to respond quickly and dependably to a broad range of fires.
- Sleek, low-profile design.
- Integral communications and built-in type identification.
- Built-in tamper-resistant feature.
- Removable cover and insect-resistant screen for simple field cleaning.

#### Operation:

- Withstands air velocities up to 4,000 feet-per-minute (20 m/sec.) without triggering a false alarm.
- Factory preset at 1.5% nominal sensitivity for panel alarm threshold level.
- Visible LED "blinks" when the unit is addressed (communicating with the fire panel) and latches on in alarm.

#### Mechanicals:

- Sealed against back pressure.
- Direct surface mounting or electrical box mounting.
- Mounts to: single-gang box, 3.5" (8.89 cm) or 4.0" (10.16 cm) octagonal box, or 4.0" (10.16 cm) square electrical box (using a plaster ring — included).

#### Other system features:

- Fully coated circuit boards and superior RF/transient protection.
- 94-V0 plastic flammability rating.
- Low standby current.

#### Options:

- Remote LED output connection (P/N RA100Z).

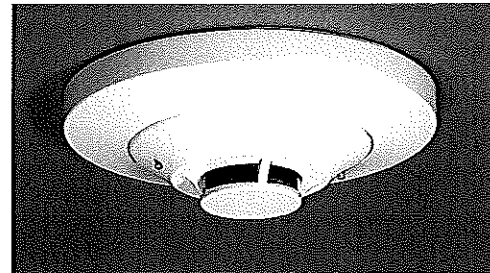

NP-100 with B710LP base

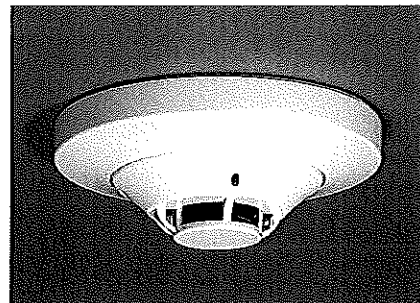

NP-100T with B710LP base

### Applications

Use photoelectric detectors in life-safety applications to provide a broad range of fire-sensing capability, especially where smoldering fires are anticipated. Ionization detectors are often better than photoelectric detectors at sensing fast, flaming fires.

### Construction

These detectors are constructed of off-white LEXAN®. NP-100(T) plug-in, low-profile smoke detectors are designed to commercial standards and offer an attractive appearance.

### Installation

NP-100(T) plug-in detectors use a detachable mounting base to simplify installation, service and maintenance. Mount base on box which is at least 1.5 inches (3.81 cm) deep. Suitable boxes include:

- 4.0" (10.16 cm) square box with plaster ring.
- 4.0" (10.16 cm) octagonal box.
- 3.5" (8.89 cm) octagonal box.
- Single-gang box.

**NOTE:** Because of the inherent supervision provided by the SLC loop, end-of-line resistors are not required. Wiring "T-taps" or branches are permitted for Style 4 (Class B) wiring. NP-100R mounts in a DNR(W) duct detector housing.

## Operation

Each NP-100/T/R uses one of 99 possible addresses on the FireWarden-100-2 and one of 50 possible addresses on the FireWarden-50 Signaling Line Circuit (SLC). It responds to regular polls from the system and reports its type and status.

The NP-100/T/R addressable photoelectric sensor's unique unipolar chamber responds quickly and uniformly to a broad range of smoke conditions and can withstand wind gusts up to 4,000 feet-per-minute (20 m/sec.) without sending an alarm level signal. Because of its unipolar chamber, the NP-100/T/R is approximately two times more responsive than most photoelectric sensors. This makes it a more stable detector.

## Detector Sensitivity Test

Each detector can have its sensitivity tested (required per NFPA 72, Chapter 14 on *Inspection, Testing and Maintenance*) when installed/connected to a FireWarden-100-2 or FireWarden-50 addressable fire alarm control panel. The results of the sensitivity test can be printed off the FireWarden-100-2 or FireWarden-50 for record keeping.

## Specification

**Voltage range:** 15 – 32 VDC (peak).

**Standby current:** 300  $\mu$ A @ 24 VDC.

**LED current:** 6.5 mA @ 24 VDC (latched "ON").

**Air velocity:** 4,000 ft./min. (20 m/sec.) maximum.

**Diameter:** 6.1" (15.5 cm) installed in B710LP base.

**Height:** 2.1" (5.33 cm) installed in B710LP base.

**Weight:** 3.6 oz. (102 g).

**Operating temperature range:** for NP-100: 0°C to 49°C (32°F to 120°F); for NP-100T: 0°C to 38°C (32°F to 100°F). NP-100R: installed in a DNR(W) -20°C to 70°C (-4°F to 158°F).

**Temperature:** 0°C – 49°C (32°F – 120°F).

**Relative humidity:** 10% – 93%, non-condensing.

## Listings

Listings and approvals below apply to the NP-100 and NP-100T detectors. In some cases, certain modules may not be listed by certain approval agencies, or listing may be in process. Consult factory for latest listing status.

- UL Listed, file S1115.
- CSFM approved: file 7272-0028:231.
- MEA approved: file 243-02-E Vol. 2.
- Maryland State Fire Marshal: permit 2173.
- FM approved.

## Product Line Information

**NP-100:** Addressable photoelectric detector; B710LP base included.

**NP-100A:** Same as NP-100 with ULC Listing (B710LPA base included).

**NP-100T:** Same as NP-100 but with *thermal* element; B710LP base included.

**NP-100TA:** Same as NP-100T with ULC Listing (B710LPAbase included).

**NP-100R:** Remote test capable addressable photoelectric detector for use with a DNR(W) duct detector housing.

**B710LP:** Plug-in detector base. Dimensions: 6.1" (15.5 cm). Mounting: 4.0" (10.16 cm) square box with or without plaster ring, 4.0" (10.16 cm) octagonal box, 3.5" (8.89 cm) octagonal box, or single-gang box. All mounting boxes have a minimum depth of 1.5" (3.81 cm).

**B224RB:** Plug-in System Sensor *relay* detector base. **Diameter:** 6.2" (15.75 cm). **Mounting:** 4.0" (10.16 cm) square box with or without plaster ring, 4.0" (10.16 cm) octagonal box, or 3.5" (8.89 cm) octagonal box. All mounting boxes have a minimum depth of 1.5" (3.81 cm).

**B224BI:** Plug-in System Sensor *isolator* detector base. Maximum 25 devices between isolator bases (*see DN-6994*). **Diameter:** 6.2" (15.75 cm). **Mounting:** 4.0" (10.16 cm) square box with or without plaster ring, 4.0" (10.16 cm) octagonal box, or 3.5" (8.89 cm) octagonal box. All mounting boxes have a minimum depth of 1.5" (3.81 cm).

**B200SR:** Sounder base capable of producing temporal-3 or steady sound output.

### ACCESSORIES:

**RA100Z(A):** Remote LED annunciator. 3 – 32 VDC. Mounts to a U.S. single-gang electrical box. *For use with B501 and B710LP bases only.*

**SMK400E:** Surface mounting kit provides for entry of surface wiring conduit. *For use with B501 base only.*

**RMK400:** Recessed mounting kit. *For use with B501 base only.*

**M02-04-00:** Test magnet.

**M02-09-00:** Test magnet with telescoping handle.

**XR2B:** Detector removal tool. Allows installation and/or removal of detector heads from bases in high ceiling applications.

**XP-4:** Extension pole for XR2B. Comes in three 5-foot (1.524 m) sections.

**T55-127-010:** Detector removal tool without pole.

**BCK-200B:** Black detector covers, box of 10 .

**WCK-200B:** White detector covers, box of 10 .

---

NOTIFIER® is a registered trademark of Honeywell International Inc. Bayblend® is a registered trademark of Bayer Corporation. ©2008 by Honeywell International Inc. All rights reserved. Unauthorized use of this document is strictly prohibited.

---



This document is not intended to be used for installation purposes.  
We try to keep our product information up-to-date and accurate.  
We cannot cover all specific applications or anticipate all requirements.  
All specifications are subject to change without notice.

# Monitor Modules

**NMM-100(A), NMM-100P(A), NZM-100(A), and NDM-100(A)**  
for FireWarden Series Panels

**NOTIFIER**<sup>®</sup>  
by Honeywell

Intelligent Addressable Devices

## General

Four different monitor modules are available for Notifier's FireWarden Series intelligent control panels for a variety of applications. Monitor modules supervise a circuit of dry-contact input devices, such as conventional heat detectors and pull stations, or monitor and power a circuit of two-wire smoke detectors (NZM-100(A)).

**NMM-100(A)** is a standard-sized module (typically mounts to a 4" [10.16 cm] square box) that supervises either a Style D (Class A) or Style B (Class B) circuit of dry-contact input devices.

**NMM-100P(A)** is a miniature monitor module a mere 1.3" (3.302 cm) H x 2.75" (6.985 cm) W x 0.5" (1.270 cm) D that supervises a Style B (Class B) circuit of dry-contact input devices. Its compact design allows the NMM-100P(A) to often be mounted in a single-gang box behind the device it monitors.

**NZM-100(A)** is a standard-sized module that monitors and supervises compatible two-wire, 24 volt, smoke detectors on a Style D (Class A) or Style B (Class B) circuit.

**NDM-100(A)** is a standard-sized dual monitor module that monitors and supervises two independent two-wire Style B (Class B) dry-contact initiating device circuits (IDCs) at two separate, consecutive addresses in intelligent, two-wire systems.

### NMM-100(A) Monitor Module

- Built-in type identification automatically identifies this device as a monitor module to the control panel.
- Powered directly by two-wire SLC loop. No additional power required.
- High noise (EMF/RFI) immunity.
- SEMS screws with clamping plates for ease of wiring.
- Direct Decade entry of address: 01 – 99 on FireWarden-100-2, 01 – 50 on FireWarden-50.
- LED flashes during normal operation and latches on steady to indicate alarm.

The NMM-100(A) Monitor Module is intended for use in intelligent, two-wire systems, where the individual address of each module is selected using the built-in rotary switches. It provides either a two-wire or four-wire fault-tolerant Initiating Device Circuit (IDC) for normally-open-contact fire alarm and supervisory devices. The module has a panel-controlled LED indicator.

### NMM-100(A) APPLICATIONS

Use to monitor a zone of four-wire smoke detectors, manual fire alarm pull stations, waterflow devices, or other normally-open dry-contact alarm activation devices. May also be used to monitor normally-open supervisory devices with special supervisory indication at the control panel. Monitored circuit may be wired as an NFPA Style B (Class B) or Style D (Class A) Initiating Device Circuit. A 47K ohm End-of-Line Resistor (provided) terminates the Style B circuit. No resistor is required for supervision of the Style D circuit.

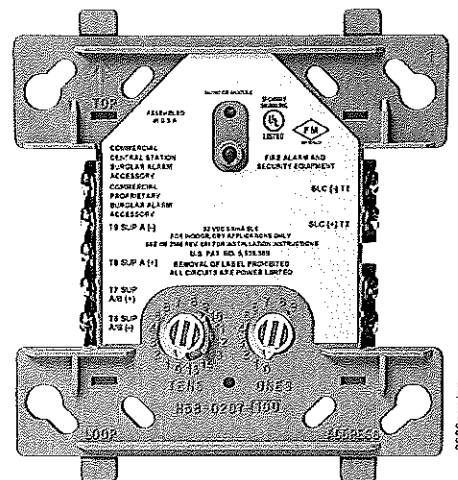

NMM-100(A) (Type H)

### NMM-100(A) OPERATION

Each NMM-100(A) uses one of the available module addresses on an SLC loop. It responds to regular polls from the control panel and reports its type and the status (open/normal/short) of its Initiating Device Circuit (IDC). A flashing LED indicates that the module is in communication with the control panel. The LED latches steady on alarm (subject to current limitations on the loop).

### NMM-100(A) SPECIFICATIONS

**Nominal operating voltage:** 15 to 32 VDC.

**Maximum current draw:** 5.0 mA (LED on).

**Average operating current:** 350  $\mu$ A (LED flashing), 1 communication every 5 seconds, 47k EOL.

**Maximum IDC wiring resistance:** 40 ohms.

**EOL resistance:** 47K ohms.

**Temperature range:** 32°F to 120°F (0°C to 49°C).

**Humidity range:** 10% to 93% noncondensing.

**Dimensions:** 4.5" (11.43 cm) high x 4" (10.16 cm) wide x 1.25" (3.175 cm) deep. Mounts to a 4" (10.16 cm) square x 2.125" (5.398 cm) deep box.

### NMM-100P(A) Mini Monitor Module

- Built-in type identification automatically identifies this device as a monitor module to the panel.
- Powered directly by two-wire SLC loop. No additional power required.
- High noise (EMF/RFI) immunity.
- Tinned, stripped leads for ease of wiring.
- Direct Decade entry of address: 01 – 99 on FireWarden-100-2, 01 – 50 on FireWarden-50.

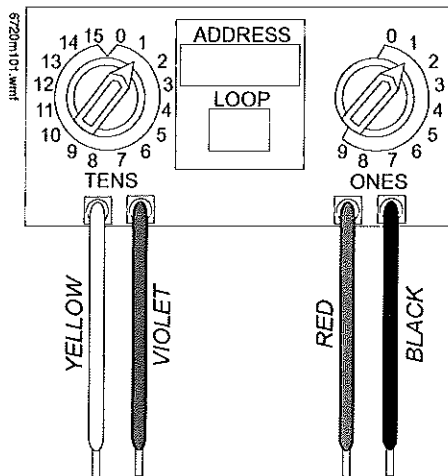

The NMM-100P(A) Mini Monitor Module can be installed in a single-gang junction directly behind the monitored unit. Its small size and light weight allow it to be installed without rigid mounting. The NMM-100P(A) is intended for use in intelligent, two-wire systems where the individual address of each module is selected using rotary switches. It provides a two-wire initiating device circuit for normally-open-contact fire alarm and security devices. NMM-100P(A)

#### **NMM-100P(A) APPLICATIONS**

Use to monitor a single device or a zone of four-wire smoke detectors, manual fire alarm pull stations, waterflow devices, or other normally-open dry-contact devices. May also be used to monitor normally-open supervisory devices with special supervisory indication at the control panel. Monitored circuit/device is wired as an NFPA Style B (Class B) Initiating Device Circuit. A 47K ohm End-of-Line Resistor (provided) terminates the circuit.

#### **NMM-100P(A) OPERATION**

Each NMM-100P(A) uses one of the available module addresses on an SLC loop. It responds to regular polls from the control panel and reports its type and the status (open/normal/short) of its Initiating Device Circuit (IDC).

#### **NMM-100P(A) SPECIFICATIONS**

**Nominal operating voltage:** 15 to 32 VDC.

**Average operating current:** 350  $\mu$ A, 1 communication every 5 seconds, 47k EOL; 600  $\mu$ A Max. (Communicating, IDC Shorted).

**Maximum IDC wiring resistance:** 40 ohms.

**Maximum IDC Voltage:** 11 Volts.

**Maximum IDC Current:** 400  $\mu$ A.

**EOL resistance:** 47K ohms.

**Temperature range:** 32°F to 120°F (0°C to 49°C).

**Humidity range:** 10% to 93% noncondensing.

**Dimensions:** 1.3" (3.302 cm) high x 2.75" (6.985 cm) wide x 0.65" (1.651 cm) deep.

**Wire length:** 6" (15.24 cm) minimum.

#### **NZM-100(A) Interface Module**

- Supports compatible two-wire smoke detectors.
- Supervises IDC wiring and connection of external power source.
- High noise (EMF/RFI) immunity.
- SEMS screws with clamping plates for ease of wiring.

- Direct Decade entry of address; 01 – 99 on FireWarden-100-2, 01 – 50 on FireWarden-50.
- LED flashes during normal operation.
- LED latches steady to indicate alarm on command from control panel.

The NZM-100(A) Interface Module is intended for use in intelligent, addressable systems, where the individual address of each module is selected using built-in rotary switches. This module allows intelligent panels to interface and monitor two-wire conventional smoke detectors. It transmits the status (normal, open, or alarm) of one full zone of conventional detectors back to the control panel. All two-wire detectors being monitored must be UL compatible with the module.

#### **NZM-100(A) APPLICATIONS**

Use the NZM-100(A) to monitor a zone of two-wire smoke detectors. The monitored circuit may be wired as an NFPA Style B (Class B) or Style D (Class A) Initiating Device Circuit. A 3.9 K ohm End-of-Line Resistor (provided) terminates the end of the Style B or D (class B or A) circuit (maximum IDC loop resistance is 25 ohms). Install ELR across terminals 8 and 9 for Style D application.

#### **NZM-100(A) OPERATION**

Each NZM-100(A) uses one of the available module addresses on an SLC loop. It responds to regular polls from the control panel and reports its type and the status (open/normal/short) of its Initiating Device Circuit (IDC). A flashing LED indicates that the module is in communication with the control panel. The LED latches steady on alarm (subject to current limitations on the loop).

#### **NZM-100(A) SPECIFICATIONS**

**Nominal operating voltage:** 15 to 32 VDC.

**Maximum current draw:** 5.1 mA (LED on).

**Maximum IDC wiring resistance:** 25 ohms.

**Average operating current:** 300  $\mu$ A, 1 communication and 1 LED flash every 5 seconds, 3.9k eol.

**EOL resistance:** 3.9K ohms.

**External supply voltage (between Terminals T3 and T4):**

DC voltage: 24 volts power limited. Ripple voltage: 0.1 Vrms maximum. Current: 90 mA per module maximum.

**Temperature range:** 32°F to 120°F (0°C to 49°C).

**Humidity range:** 10% to 93% noncondensing.

**Dimensions:** 4.5" (11.43 cm) high x 4" (10.16 cm) wide x 1.25" (3.175 cm) deep. Mounts to a 4" (10.16 cm) square x 2.125" (5.398 cm) deep box.

#### **NDM-100(A) Dual Monitor Module**

The NDM-100(A) Dual Monitor Module is intended for use in intelligent, two-wire systems. It provides two independent two-wire initiating device circuits (IDCs) at two separate, consecutive addresses. It is capable of monitoring normally open contact fire alarm and supervisory devices. The module has a single panel-controlled LED.

**NOTE:** The NDM-100(A) provides two Style B (Class B) IDC circuits ONLY. Style D (Class A) IDC circuits are NOT supported in any application.

#### **NDM-100(A) SPECIFICATIONS**

**Normal operating voltage range:** 15 to 32 VDC.

**Maximum current draw:** 6.4 mA (LED on).

**Average operating current:** 750  $\mu$ A (LED flashing).

**Maximum IDC wiring resistance:** 1,500 ohms.

**Maximum IDC Voltage:** 11 Volts.

**Maximum IDC Current:** 240  $\mu$ A

**EOL resistance:** 47K ohms.

**Maximum SLC Wiring resistance:** 40 Ohms.

**Temperature range:** 32° to 120°F (0° to 49°C).

**Humidity range:** 10% to 93% (non-condensing).

**Dimensions:** 4.5" (11.43 cm) high x 4" (10.16 cm) wide x 2.125" (5.398 cm) deep.

### **NDM-100(A) AUTOMATIC ADDRESSING**

The NDM-100(A) automatically assigns itself to two addressable points, starting with the original address. For example, if the NDM-100(A) is set to address "26", then it will automatically assign itself to addresses "26" and "27".

**NOTE:** "Ones" addresses on the NDM-100(A) are 0, 2, 4, 6, or 8 only. Terminals 6 and 7 use the first address, and terminals 8 and 9 use the second address.



#### **CAUTION:**

Avoid duplicating addresses on the system.

---

## **Installation**

NMM-100(A), NZM-100(A), and NDM-100(A) modules mount directly to a standard 4" (10.16 cm) square, 2.125" (5.398 cm) deep, electrical box. They may also be mounted to the SMB500 surface-mount box. Mounting hardware and installation instructions are provided with each module. All wiring must conform to applicable local codes, ordinances, and regulations. These modules are intended for power-limited wiring only.

The NMM-100P(A) module is intended to be wired and mounted without rigid connections inside a standard electrical box. All wiring must conform to applicable local codes, ordinances, and regulations.

## **Agency Listings and Approvals**

In some cases, certain modules may not be listed by certain approval agencies, or listing may be in process. Consult factory for latest listing status.

- **UL:** S635
- **ULC:** S635
- **FM Approved**
- **CSFM:** 7300-0028:230 (NMM-100, NMM-100P, NZM-100); 7300-0028:237 (NDM-100)
- **MEA:** 72-01-E Vol. 2 (NMM-100, NMM-100P, NZM-100); 227-03-E Vol. 3 (NDM-100)

## **Product Line Information**

**NOTE:** "A" or suffix indicates ULC-listed model.

**NMM-100(A):** Monitor module.

**NMM-100P(A):** Monitor module, miniature.

**NZM-100(A):** Monitor module, two-wire detectors.

**NDM-100(A):** Monitor module, dual, two Independent Class B circuits.

**SMB500:** Optional surface-mount backbox.

**NOTE:** See installation instructions and refer to the SLC Wiring Manual, PN 52304.



---

Notifier® and FireWarden® are registered trademarks and FireWatch™ is a trademark of Honeywell International Inc.  
©2009 by Honeywell International Inc. All rights reserved. Unauthorized use of this document is strictly prohibited.

---

**ISO 9001**  
**CERTIFIED**  
ENGINEERING & MANUFACTURING  
QUALITY SYSTEMS

This document is not intended to be used for installation purposes.  
We try to keep our product information up-to-date and accurate.  
We cannot cover all specific applications or anticipate all requirements.  
All specifications are subject to change without notice.



Made in the U.S. A.

# Wheelock® Exceder™

## Horns and Strobes

**NOTIFIER®**  
by Honeywell

Audio/Visual Devices

### General

The Wheelock® Exceder™ Series of notification appliances feature a sleek modern design and numerous features including eight candela options in one appliance, low current draw, no tools needed for setting changes, 12/24 VDC operation, universal mounting base and multiple mounting options.

Models with an audible feature 3 sound settings (90, 95, 99 dB). All switches to change settings can be set without the use of a tool and are located behind the appliance to prevent tampering. Wall models feature voltage test points to take readings with a voltage meter for troubleshooting and AHJ inspection.

The Wheelock® Exceder™ Series of wall and ceiling notification appliances feature a Universal Mounting Base (UMB) designed to simplify the installation and testing of horns, strobes, and combination horn strobes. The separate universal mounting base can be pre-wired to allow full testing of circuit wiring before the appliance is installed and the surface is finished. It comes complete with a contact cover for protection against dirt, dust, paint and damage to the contacts. The contact cover also acts as a shunting device to allow pre-wire testing for common wiring issues.

The contact cover is polarized to prevent it from being installed incorrectly and prevents the appliance from being installed while it is on the UMB. When the contact cover is removed the circuit will show an open until the appliance is installed. The UMB allows for consistent installation and easy replacement of appliances if required. Wall models provide an optional locking screw for extra secure installation, while the ceiling models provide a captive screw to prevent the screw from falling during installation.

### Features

- Multiple voltages
- Voltage test points for quick troubleshooting and easy spot-checking (wall models only)
- 3 audible settings (90, 95, 99 dB)
- 8 Candela settings
  - Wall - 15/1575/30/75/95/110/135/185
  - Ceiling - 15, 30, 60, 75, 95, 115, 150, 177
- Finger-slide switches
- Sleek modern aesthetics
- Common base for wall and ceiling with 5 mounting options:
  - 1-gang
  - 2-gang
  - 4 inch square
  - 3.5 inch octagonal
  - 4 inch octagonal

### Compatibility and Requirements

- Synchronize using Wheelock Sync Modules, or panels with built-in Wheelock patented sync protocol.
- Compatible with UL "Regulated Voltage" using filtered VDC or unfiltered VRMS input voltage
- Strobes produce one flash per second over the Regulated Voltage range.

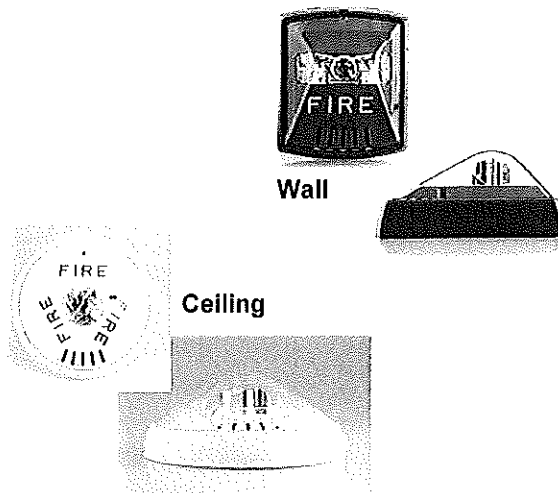

### General Notes

- All candela ratings represent minimum effective strobe intensity based on UL Standard 1971.
- Series Exceder Strobe products are Listed under UL Standards 1971 and 464 for indoor use with a temperature range of 32°F to 120°F (0°C to 49°C) and maximum humidity of 93% (± 2%) UL 464 (85% UL 1971).
- Series Exceder horns are under UL Standard 464 for audible signal appliances (indoor use only).
- Product naming conventions: The Exceder line's model codes break down into easy-to-remember codes. HN = Horn, ST = Strobe, HS = Horn-strobe, C = Ceiling Mount, W = White, and R = Red. So "STRC" can be read as "Strobe, Red, Ceiling-mount.", and "HSW" is "Horn-strobe, white, wall-mount."
- Refer to your fire alarm panel or power supply manual when calculating the number of devices allowed per circuit.

### Architects/Engineers Specifications

The notification appliances shall be Wheelock Exceder Series HS Audible Strobe appliances, Series ST Visual Strobe appliances and Series HN Audible appliances or approved equals. The Series HS and ST Strobes shall be listed for UL Standard 1971 (Emergency Devices for the Hearing-Impaired) for Indoor Fire Protection Service. The Series HS and HN Audibles shall be UL Listed under Standard 464 (Fire Protective Signaling). All Series shall meet the requirements of FCC Part 15 Class B. All inputs shall be compatible with standard reverse polarity supervision of circuit wiring by a Fire Alarm Control Panel (FACP) with the ability to operate from 8 to 33 VDC. Indoor wall models shall incorporate voltage test points for easy voltage inspection.

The Series HS Audible Strobe and ST Strobe appliances shall produce a flash rate of one flash per second over the Regulated Voltage Range and shall incorporate a Xenon flashtube enclosed in a rugged Lexan® lens. The Series shall be of low current design. Where Multi-Candela appliances are specified, the strobe intensity shall have 8 field selectable settings at 15,

15/75, 30, 75, 95, 110, 135, 185 candela for wall mount and 15, 30, 60, 75, 95, 115, 150, 177 candela for ceiling mount. The selector switch for selecting the candela shall be tamper resistant. The 15/75 candela strobe shall be specified when 15 candela UL Standard 1971 Listing with 75 candela on-axis is required (e.g. ADA compliance). Appliances with candela settings shall show the candela selection in a visible location at all times when installed.

The audible shall have a minimum of three field selectable settings for dBA levels and shall have a choice of continuous or temporal (Code 3) audible outputs.

**MOUNTING OPTIONS**

The Series HS Audible Strobe, ST Strobe and Series HN Audible shall incorporate a patented Universal Mounting Base that shall allow mounting to a single-gang, double-gang, 4" square, 3.5" octagonal, 4" octagonal or 100mm European type back boxes. Two wire appliance wiring shall be capable of directly connecting to the mounting base. Continuity checking of the entire NAC circuit prior to attaching any notification appliances shall be allowed. Product shall come with contact cover to protect contact springs. Removal of an appliance shall result in a supervision fault condition by the Fire Alarm Control Panel (FACP). The mounting base shall be the same base among all horn, strobe, horn strobe, wall and ceiling models. All notification appliances shall be backwards compatible.

**PHYSICAL SPECIFICATIONS**

The Series HS and ST wall models shall have a low profile measuring 5.24" H x 4.58" W x 2.19" D. Series HN wall shall measure 5.24" H x 4.58" W x 1.6" D. The Series HSC and STC

shall be round and have a low profile with a diameter of 6.68" x 2.63" D. Series HNC ceiling shall have a diameter of 6.68" x 1.50" D.

**SYNCHRONIZATION**

When synchronization is required, the appliance shall be compatible with Wheelock®s SM, DSM Sync Modules, Wheelock® Power Supplies or other manufacturer's panels with built-in Wheelock® Patented Sync Protocol. The strobes shall not drift out of synchronization at any time during operation. If the sync protocol fails to operate, the strobe shall revert to a non-synchronized flash-rate and still maintain one flash per second over its Regulated Voltage Range. The appliance shall also be designed so that the audible signal may be silenced while maintaining strobe activation when used with Wheelock® synchronization protocol.

**Standards and Codes**

Modules in this series comply with UL Standard 1971, UL Standard 464, California State Fire Marshal (CSFM), and ULC.

**Agency Listings**

These listings and approvals apply to the modules specified in this document. In some cases, certain modules or applications may not be listed by certain approval agencies, or listing may be in process. Consult factory for latest listing status.

- **UL Listed:** S5391 (Strobes); E5946 (Horns, Horn/strobes).
- **ULC Listed**
- **CSFM Listed:** 7125-0785:168.

**Specification & Ordering Information**

| Model   | Strobe Candela                       | 12/24 VDC | Mounting Options        |
|---|--------------------------------------|-----------|-------------------------|
| <b>Horn Strobes</b>   |                                      |           |                         |
| HSR   | 15, 15/75, 30, 75, 95, 110, 135, 185 | X         | Universal Mounting Base |
| HSW   | 15, 15/75, 30, 75, 95, 110, 135, 185 | X         | Universal Mounting Base |
| HSRC  | 15, 30, 60, 75, 95, 115, 150, 177    | X         | Universal Mounting Base |
| HSWC  | 15, 30, 60, 75, 95, 115, 150, 177    | X         | Universal Mounting Base |
| <b>Strobes</b>  |                                      |           |                         |
| STR   | 15, 15/75, 30, 75, 95, 110, 135, 185 | X         | Universal Mounting Base |
| STW   | 15, 15/75, 30, 75, 95, 110, 135, 185 | X         | Universal Mounting Base |
| STRC  | 15, 30, 60, 75, 95, 115, 150, 177    | X         | Universal Mounting Base |
| STWC  | 15, 30, 60, 75, 95, 115, 150, 177    | X         | Universal Mounting Base |
| <b>Horns</b>  |                                      |           |                         |
| HNR   | —                                    | X         | Universal Mounting Base |
| HNW   | —                                    | X         | Universal Mounting Base |
| HNRC  | —                                    | X         | Universal Mounting Base |
| HNWC  | —                                    | X         | Universal Mounting Base |
| *12 VDC models feature 15 and 15/75 settings  |                                      |           |                         |
| <b>NOTE:</b> Due to continuous development of Cooper Wheelock products, specifications and offerings are subject to change without notice in accordance with Cooper Wheelock Inc., dba Cooper Notification standard terms and conditions. |                                      |           |                         |

Notifier® is a registered trademark of Honeywell International Inc.  
 Exceder is a trademark and Wheelock® is a registered trademark of Cooper Notification.  
 ©2010 by Honeywell International Inc. All rights reserved. Unauthorized use of this document is strictly prohibited.

This document is not intended to be used for installation purposes.  
 We try to keep our product information up-to-date and accurate.  
 We cannot cover all specific applications or anticipate all requirements.  
 All specifications are subject to change without notice.



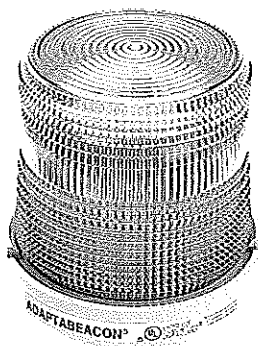

## AdaptaBeacon® Flashing Incandescent Lights

**PLC Compatible  
NEMA Type 4X**

**48FIN Series**

### FEATURES

- > Weatherproof
- > 25W Halogen lamp in 120V AC Model; 20W Halogen lamp in 24V AC and 24V DC Models
- > Snap-on high impact polycarbonate/ABS base
- > Shatter resistant polycarbonate lens

### AGENCY APPROVALS

- > UL 1638 Listed
- > UL Listed NEMA Type 4X enclosure
- > cUL Listed

The Edwards 48 Series AdaptaBeacon flashing lights incorporate a unique double fresnel lens that has been optically engineered to maximize brilliance. This is accomplished with a series of complementing fresnels that cause the dome to "fill" when the light is operating. Beam distance is also increased with fresnel lenses. The incandescent lights are available in six colors: red, amber, blue, green, magenta, and clear.

Designed for indoor or outdoor installation. May be direct or 1/2" (13mm) conduit mounted. For weatherproof installation, units must be mounted vertically with the lens facing up. Use Cat. No. GSK-KIT gasket kit for weatherproof surface installation of AC models. May be corner mounted indoors using the Cat. No. CBR, corner mount bracket, or wall mounted indoors using the Cat. No. WBR, wall mount bracket. See Adaptabeacon Accessories, page 3-118.

Edwards flashing lights are particularly effective in high noise level areas, especially where ear protection must be worn and audible signals may not be heard or understood. They can advise personnel in manufacturing and process areas when an operation is starting or stopping. Often used to signal malfunctions in equipment, such as assembly line jams. Can warn personnel that they are entering a restricted area or an area of high danger. May be used where a smaller light output is desired or where many multiple smaller flashing lights are specified. The gasketed NEMA 4X enclosure ensures installation acceptability in most industrial and commercial locations.

D-04



## TECHNICAL INFORMATION

Use Cat. No. GSK-KIT gasket kit for weatherproof surface mount installation on AC units

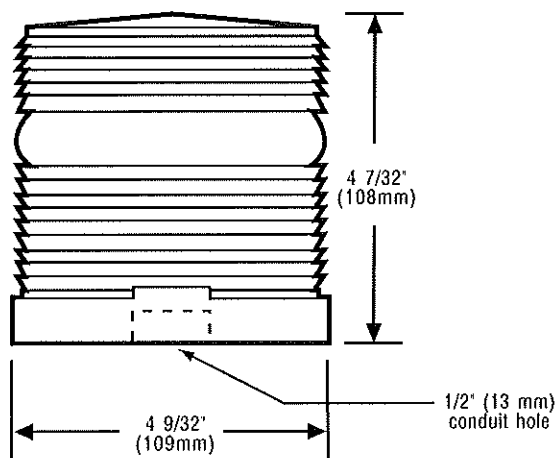

| Cat. No.       | Lens Color | Replacement Lens | Lamp Ratings     | Replacement Flasher | Electrical Ratings | Replacement Lamp |
|----------------|------------|------------------|------------------|---------------------|--------------------|------------------|
| 48FINR-N5-25WH | Red        | 96-LR            | 25 watts         | P-041917-0026       | 120V 50/60 Hz      | 50LMP-25WH       |
| 48FINA-N5-25WH | Amber      | 96-LA            | 175 Lumens*      |                     | 0.20 Amps          | or               |
| 48FINB-N5-25WH | Blue       | 96-LB            | 2198 candlepower |                     |                    | Ind. Trade       |
| 48FING-N5-25WH | Green      | 96-LG            | 25,000 hr.**     |                     |                    | No. 25T8DC       |
| 48FINM-N5-25WH | Magenta    | 96-LM            |                  |                     |                    |                  |
| 48FINC-N5-25WH | Clear      | 96-LC            |                  |                     |                    |                  |
| 48FINR-G5-20WH | Red        | 96-LR            | 20 Watts         | P-041917-0029       | 24V 50/60 Hz       | 60LMP-20WH       |
| 48FINA-G5-20WH | Amber      | 96-LA            | 226 Lumens*      |                     | 0.80 Amps          | or               |
| 48FINB-G5-20WH | Blue       | 96-LB            | 2839 candlepower |                     |                    | Ind. Trade       |
| 48FING-G5-20WH | Green      | 96-LG            | 25,000 hr.**     |                     |                    | No. 1692         |
| 48FINM-G5-20WH | Magenta    | 96-LM            |                  |                     |                    |                  |
| 48FINC-G5-20WH | Clear      | 96-LC            |                  |                     |                    |                  |
| 48FINR-E1      | Red        | 96-LR            | 13 watts         | P-041917-0028       | 12V DC             | Ind. Trade       |
| 48FINA-E1      | Amber      | 96-LA            | 189 Lumens*      |                     | 1.0 Amps           | No. 94           |
| 48FINB-E1      | Blue       | 96-LB            | 2374 candlepower |                     |                    |                  |
| 48FING-E1      | Green      | 96-LG            | 1,520 hr.**      |                     |                    |                  |
| 48FINM-E1      | Magenta    | 96-LM            |                  |                     |                    |                  |
| 48FINC-E1      | Clear      | 96-LC            |                  |                     |                    |                  |
| 48FINR-G1-20WH | Red        | 96-LR            | 20 watts         | P-041917-0029       | 24V DC             | 50LMP-20WH       |
| 48FINA-G1-20WH | Amber      | 96-LA            | 226 Lumens*      |                     | 0.80 Amps          | or               |
| 48FINB-G1-20WH | Blue       | 96-LB            | 2839 candlepower |                     |                    | Ind. Trade       |
| 48FING-G1-20WH | Green      | 96-LG            | 25,000 hr.**     |                     |                    | No. 1692         |
| 48FINM-G1-20WH | Magenta    | 96-LM            |                  |                     |                    |                  |
| 48FINC-G1-20WH | Clear      | 96-LC            |                  |                     |                    |                  |

\*Bulb manufacturer's lumen rating.

\*\*Projected lamp life based on manufacturer's calculated lamp life at 65 fpm and 50% duty cycle.

## SIGNAL INPUT LOAD CHARACTERISTICS\*

| Cat. No.         | Operating Voltage | Max. off state leakage current (mA) | Continuous on Current (mA) | Surge (inrush/duration) Amps/milliseconds |
|------------------|-------------------|-------------------------------------|----------------------------|---|
| 48FIN(-)-G1-20WH | 24V DC            | 25                                  | 800                        | 2.2/100                                   |
| 48FIN(-)-N5-25WH | 120V AC 60 Hz     | 25                                  | 200                        | 1.3/8                                     |

\*This device is PLC compatible and may be operated by PLCs with output characteristics that match the input load requirements of this signal.

**NO  
EXCUSES!**

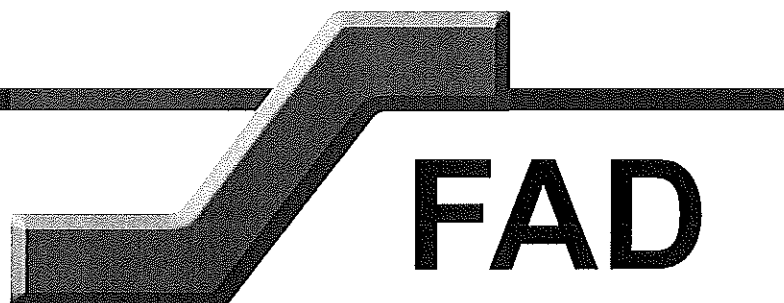
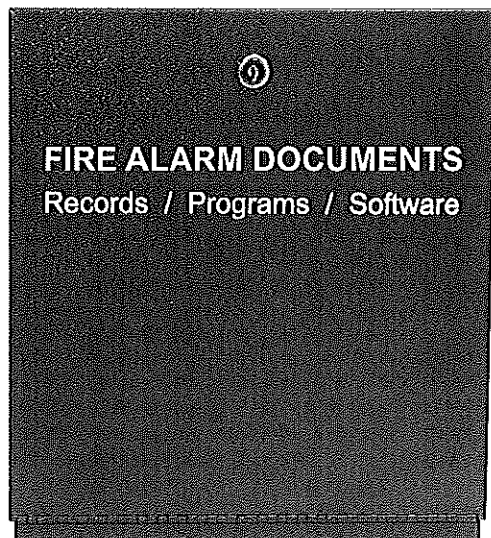

## Fire Alarm Documents Records / Programs / Software

The FAD is the perfect fit to meet the demanding code requirements today. SAE's number one goal is to manufacture code compliant solutions and this product allows you to do just that. NFPA 72 section 6.2.2.1 states, "A record of installed software and firmware version numbers shall be maintained at the location of the fire alarm control unit."

This durable 16 gauge steel enclosure with a solid piano hinge and key lock will keep all of your code required documents in one safe place. With a 2GB USB flash drive it stores your fire alarm software safe and secure eliminating the occurrences of the software not being on site when technicians arrive to service the system. Along with your fire alarm software you can store your test & inspection documents, service records, manuals & AS built drawings for the system. Using a standard USB B connector it allows you to plug in with any standard SB printer cable to upload or download information.

NFPA 72 section 10.18.2.1.2.8 If the documents are located in a separate enclosure or cabinet, the separate enclosure or cabinet shall be prominently labeled  
**FIRE ALARM DOCUMENTS.**

### Standard Features:

- Installed with a 2 gig digital flash drive with USB B connector
- 2 Key ring hooks to hold system keys
- Business card holder for key contacts
- Overall Dimensions are 12" x 13" tall and 2 1/4" deep
- 16 gauge steel box and cover for security
- durable powercoat baked on finish other colors available
- standard 3/4" cat 30 key lock other lock assemblies available
- Solid stainless steel piano hinge
- permanently screened white ink 1" high "Fire Alarm Documents"
- Legend sheet for passwords and system information

The FAD is designed to hold critical manuals and documents with a durable steel sleeve. It has designated hooks to organize key rings and hold important business cards for easy access and reference. Inside the cover it has a organized note table that allows for documentation for passwords and other critical system information. The steel sleeve can be easily removed to hold a 1.5" three ring binder.

The innovation of a single gang cutout inside the box to implement the infinity line products with conduit knockout access enables you to provide other system functions for test and inspection. A drill switch or a shut off switch for testing are just a few examples. See the complete line of Infinity products for single gang electrical product solutions.



ISO 9001  
REGISTERED  
COMPANY



**AP BOX**





# System Power Requirements

## NFW2-100 Fire Alarm Control Panel

|  |                                       |
|--|---------------------------------------|
| Protected Premises: <u>534-538 Congress St.</u>              | Date: <u>10/23/2012</u>               |
| Address: _____   |                                       |
| City: <u>Portland</u>  | State: <u>Maine</u> Zip: _____        |
| Prepared By: <u>Norris Inc.</u> Phone: <u>(207)-318-3870</u> |                                       |
| Address: <u>2257 West Broadway</u>                           | Email: _____                          |
| City: <u>South Portland</u>                                  | State: <u>Maine</u> Zip: <u>04106</u> |

**AC Branch Current Requirements** 3.00 AMPS @ 120 VAC  
 Current required by source to power the fire alarm system.

**Primary Standby Load** 0.46 Amps  
 Current load on the primary power supply during non-alarm conditions.

**Primary Alarm Load** 3.39 Amps  
 Current load on the primary power supply during alarm conditions.

**Secondary Load Requirements** 5.73 Amp Hours  
 Total Secondary Load from the calculation table below.

| Current Draw                       |   | Time (hours)                | Total (AH)     |
|------------------------------------|---|-----------------------------|----------------|
| Secondary Standby Load<br>0.187 A  | x | Required Standby Time       |                |
|                                    |   | 24 hours                    | 4.49           |
| Secondary Alarm Load<br>3.386 A    | x | Required Alarm Time (hours) |                |
|                                    |   | 0.084 hours                 | 0.28           |
| Total Secondary Load               |   |                             | 4.77           |
| Derating factor                    |   |                             | x 1.2          |
| <b>Secondary Load Requirements</b> |   |                             | <b>5.73</b> AH |

**Battery Selection** 7 Amp Hours  
 Select batteries from the list below.

7 AH BAT-1270 Battery (12 volt)

- Two       Four (two 12VDC sets in parallel)



### Battery Distribution Chart

Shows amp-hour distribution of your selections.

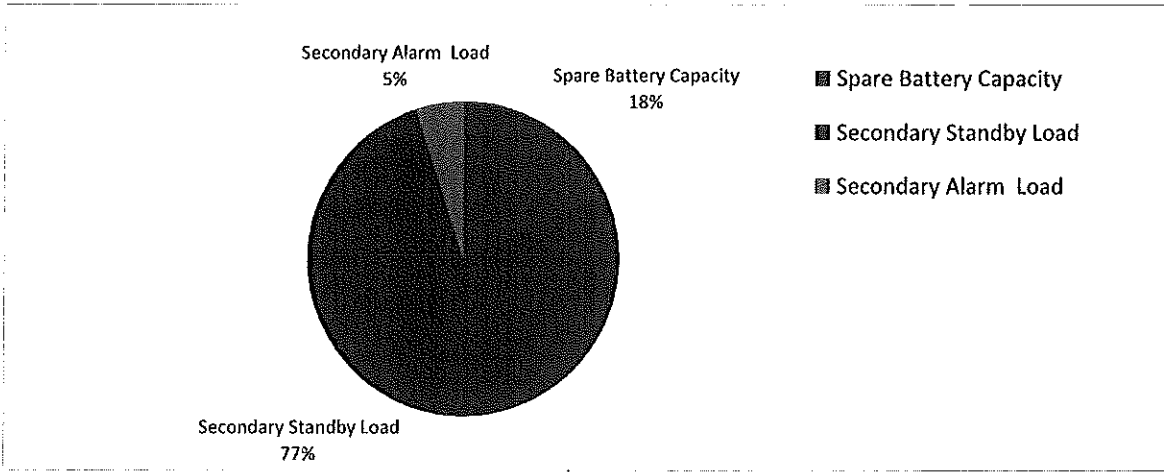

### Comments

1. Batteries will fit in the FACP cabinet.
2. Selected battery size meets secondary load requirements.
3. The selected batteries (7AH) are within the charger range of this power supply (7-18AH).

|                        |      |   |
|------------------------|------|---|
| Spare Battery Capacity | 1.27 | Battery Selection (AH) - Secondary Load Requirements (AH) |
| Secondary Standby Load | 5.38 | Secondary Standby Load (AH) * Derating Factor             |
| Secondary Alarm Load   | 0.34 | Secondary Alarm Load (AH) * Derating Factor               |

| SYSTEM INPUTS                          | CONTROL UNIT ACTIVATION |   |   |   |   |   |   |   |   |   |   |   |   |   | SYSTEM OUTPUTS                          |  |   |  |
|--|-------------------------|---|---|---|---|---|---|---|---|---|---|---|---|---|---|--|---|--|
|  | A                       | B | C | D | E | F | G | H | I | J | K | L | M | N | NOTIFICATION                            |  |   |  |
| 1 MANUAL FIRE ALARM PULL STATION       | ●                       | ● |   |   |   |   | ● | ● | ● | ● | ● |   |   |   |   |  |   |  |
| 2 AREA SMOKE DETECTOR                  | ●                       | ● |   |   |   |   | ● | ● | ● | ● | ● |   |   |   |   |  |   |  |
| 3 AREA HEAT DETECTOR                   |                         | ● |   |   |   |   | ● | ● | ● | ● | ● |   |   |   |   |  |   |  |
| 4 FIRE ALARM AC POWER FAILURE          |                         |   |   |   |   |   | ● | ● | ● | ● | ● |   |   |   |   |  |   |  |
| 5 FIRE ALARM SYSTEM LOW BATTERY        |                         |   |   |   |   |   | ● | ● | ● | ● | ● |   |   |   |   |  |   |  |
| 6 OPEN CIRCUIT                         |                         |   |   |   |   |   | ● | ● | ● | ● | ● |   |   |   |   |  |   |  |
| 7 GROUND FAULT                         |                         |   |   |   |   |   | ● | ● | ● | ● | ● |   |   |   |   |  |   |  |
| 8 NOTIFICATION APPLIANCE CIRCUIT SHORT |                         |   |   |   | ● | ● | ● | ● |   |   |   |   | ● | ● | ACTUATE COMMON ALARM SIGNAL INDICATOR   |  | TRANSMIT FIRE ALARM SIGNAL TO REMOTE ALARM RECEIVING STATION  |  |
| 9                                      |                         |   |   |   | ● | ● | ● | ● |   |   |   |   | ● | ● | ACTUATE COMMON TROUBLE SIGNAL INDICATOR |  | TRANSMIT SUPERVISORY SIGNAL TO REMOTE ALARM RECEIVING STATION |  |
| 10                                     |                         |   |   |   |   |   |   |   |   |   |   |   |   |   | ACTUATE AUDIBLE COMMON TROUBLE SIGNAL   |  | TRANSMIT TROUBLE SIGNAL TO REMOTE ALARM RECEIVING STATION     |  |
| 11                                     |                         |   |   |   |   |   |   |   |   |   |   |   |   |   | ACTUATE COMMON TROUBLE SIGNAL INDICATOR |  |   |  |
| 12                                     |                         |   |   |   |   |   |   |   |   |   |   |   |   |   | ACTUATE AUDIBLE COMMON TROUBLE SIGNAL   |  |   |  |
| 13                                     |                         |   |   |   |   |   |   |   |   |   |   |   |   |   | ACTUATE COMMON TROUBLE SIGNAL INDICATOR |  |   |  |
| 14                                     |                         |   |   |   |   |   |   |   |   |   |   |   |   |   | ACTUATE COMMON TROUBLE SIGNAL INDICATOR |  |   |  |
| 15                                     |                         |   |   |   |   |   |   |   |   |   |   |   |   |   | ACTUATE COMMON TROUBLE SIGNAL INDICATOR |  |   |  |
| 16                                     |                         |   |   |   |   |   |   |   |   |   |   |   |   |   | ACTUATE COMMON TROUBLE SIGNAL INDICATOR |  |   |  |
| 17                                     |                         |   |   |   |   |   |   |   |   |   |   |   |   |   | ACTUATE COMMON TROUBLE SIGNAL INDICATOR |  |   |  |
| 18                                     |                         |   |   |   |   |   |   |   |   |   |   |   |   |   | ACTUATE COMMON TROUBLE SIGNAL INDICATOR |  |   |  |
| 19                                     |                         |   |   |   |   |   |   |   |   |   |   |   |   |   | ACTUATE COMMON TROUBLE SIGNAL INDICATOR |  |   |  |
| 20                                     |                         |   |   |   |   |   |   |   |   |   |   |   |   |   | ACTUATE COMMON TROUBLE SIGNAL INDICATOR |  |   |  |
| 21                                     |                         |   |   |   |   |   |   |   |   |   |   |   |   |   | ACTUATE COMMON TROUBLE SIGNAL INDICATOR |  |   |  |

|                                    |                 |           |
|------------------------------------|-----------------|-----------|
| REVISION 2                         | DATE            | SCALE NTS |
| REVISION 1                         | DATE            | BY ZAB    |
| REVISION 0 SUBMITTAL               | DATE 10/23/2012 | CK BY     |
| PROJECT NAME                       |                 |           |
| Space Gallery                      |                 |           |
| Portsmouth, MAINE                  |                 |           |
| SYSTEM VIBRING RISER               |                 |           |
| 2237 BROADWAY, ST. PORTLAND, MAINE |                 |           |
| NORRIS INC                         |                 | SAVED AS  |





# System Power Requirements

## NFW2-100 Fire Alarm Control Panel

|  |                                       |
|--|---------------------------------------|
| Protected Premises: <u>534-538 Congress St.</u>              | Date: <u>11/30/2012</u>               |
| Address:   |                                       |
| City: <u>Portland</u>  | State: <u>Maine</u> Zip: _____        |
| Prepared By: <u>Norris Inc.</u> Phone: <u>(207)-318-3870</u> |                                       |
| Address: <u>2257 West Broadway</u> Email: _____              |                                       |
| City: <u>South Portland</u>                                  | State: <u>Maine</u> Zip: <u>04106</u> |

### AC Branch Current Requirements 3.00 AMPS @ 120 VAC

Current required by source to power the fire alarm system.

### Primary Standby Load 0.38 Amps

Current load on the primary power supply during non-alarm conditions.

### Primary Alarm Load 1.75 Amps

Current load on the primary power supply during alarm conditions.

### Secondary Load Requirements 4.72 Amp Hours

Total Secondary Load from the calculation table below.

| Current Draw                       |   | Time (hours)                | Total (AH)  |
|------------------------------------|---|-----------------------------|-------------|
| Secondary Standby Load<br>0.158 A  | x | Required Standby Time       |             |
|                                    |   | 24 hours                    | 3.79        |
| Secondary Alarm Load<br>1.748 A    | x | Required Alarm Time (hours) |             |
|                                    |   | 0.084 hours                 | 0.15        |
| Total Secondary Load               |   |                             | 3.93        |
| Derating factor                    |   |                             | x 1.2       |
| <b>Secondary Load Requirements</b> |   |                             | <b>4.72</b> |

AH

### Battery Selection 7 Amp Hours

Select batteries from the list below.

7 AH BAT-1270 Battery (12 volt)

- Two
  Four (two 12VDC sets in parallel)

### Battery Distribution Chart

Shows amp-hour distribution of your selections.

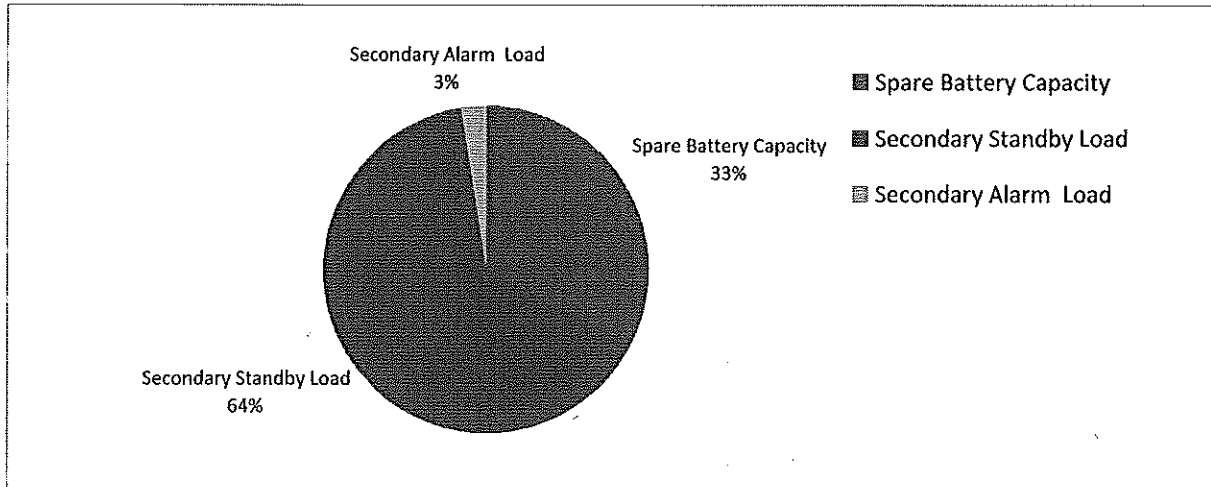

### Comments

1. Batteries will fit in the FACP cabinet.
2. Selected battery size meets secondary load requirements.
3. The selected batteries (7AH) are within the charger range of this power supply (7-18AH).

|                        |      |   |
|------------------------|------|---|
| Spare Battery Capacity | 2.28 | Battery Selection (AH) - Secondary Load Requirements (AH) |
| Secondary Standby Load | 4.54 | Secondary Standby Load (AH) * Derating Factor             |
| Secondary Alarm Load   | 0.18 | Secondary Alarm Load (AH) * Derating Factor               |

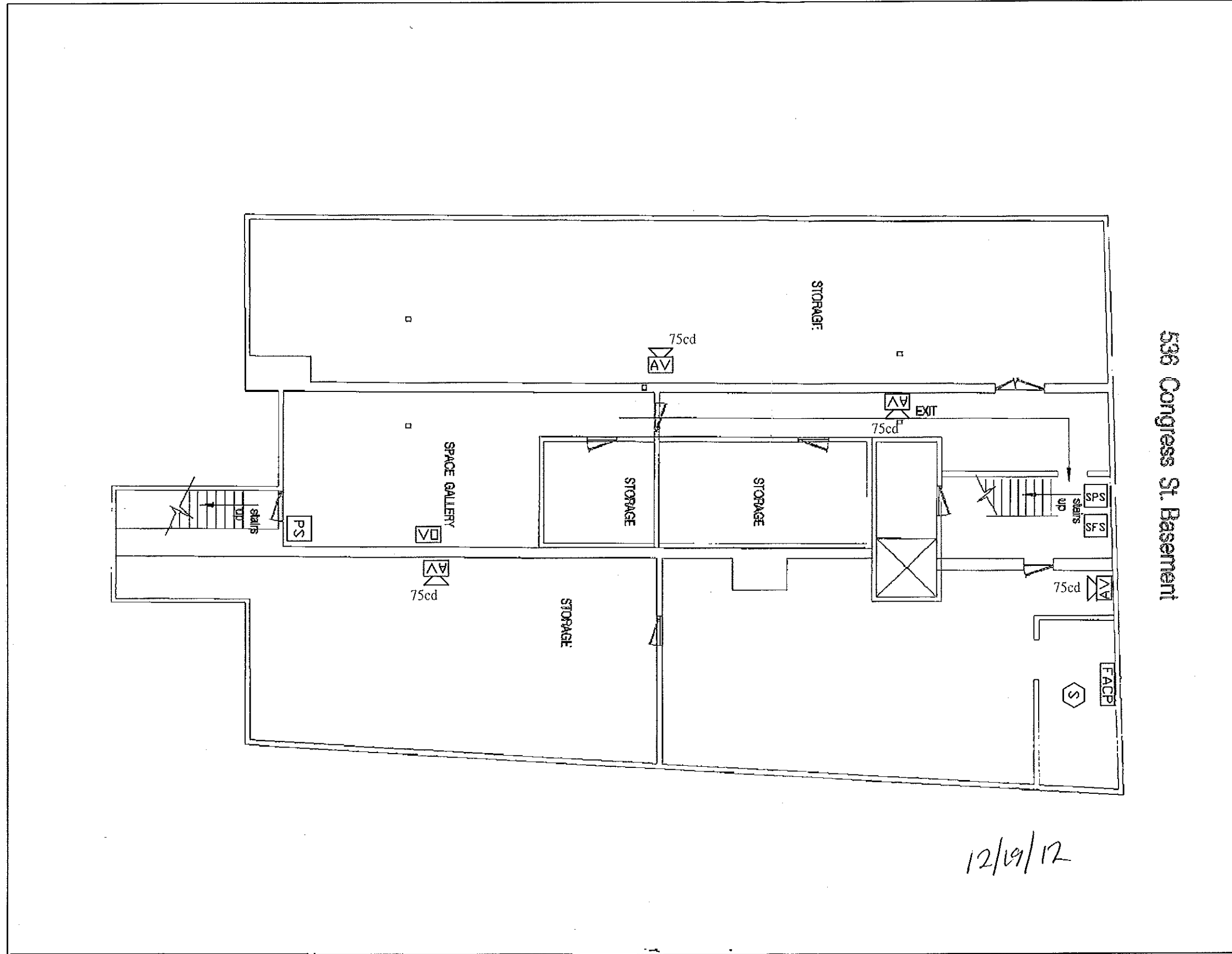

536 Congress St. Basement

**LEGEND**

- MOUNTING HEIGHT**
- 48 INCHES
- PS PULL STATION
  - S SMOKE DETECTOR
  - R HEAT DETECTOR RATE OF RISE
  - F HEAT DETECTOR FIXED TEMP
  - RT REMOTE TEST/INDICATOR
  - DS DUCT SMOKE DETECTOR
- 80 INCHES
- VD VISUAL ONLY
  - AV AUDIO / VISUAL
  - NZM 100 ZONE MODULE
  - NC-100 CONTROL MODULE
  - NMM MONITOR MODULE 100=4 SQUARE, 100p=nhmod
  - NC 100r RELAY MODULE
  - STS SPRINKLER TAMPER
  - SPS SPRINKLER PRESSURE LOW AIR
  - SFS SPRINKLER FLOW
  - DH DOOR HOLDER 120V AC

This drawing is a typical device layout, wiring is shown diagrammatically only. This drawing has been provided as an example ONLY. Riser does not necessarily indicate all devices and appliances. See floor plans and specification for location and quantities. The purchaser must accurately layout the initiating and notification devices in their proper zones/circuit. Note: All signal circuits have a 2.5 amp load limitation and a combined load limitation of 3.0 amps or 6.0 amps if XRM-24 is added to the panel. There can be 4 class B nac circuits or 2 class A nac circuits. REMOTE power supply has a 3.0 amp limitation per circuit and an 8.0 amp combined limitation for all 4 circuits. (see chart below for current vs. candela rating)

| Room Size | Candela Rating | Load (amps) |
|-----------|----------------|-------------|
| 20' x 20' | 15 cd          | 0.08 amps   |
| 28' x 28' | 30 cd          | 0.10 amps   |
| 45' x 45' | 75 cd          | 0.15 amps   |
| 54' x 54' | 110 cd         | 0.20 amps   |

- A 1 PR #12 AWG TWISTED-PAIR UNSHIELDED CABLE FPL GENESIS 4515, BELDEN 6020UL (Up to 10,000 ft)
- A 1 PR #14 AWG TWISTED-PAIR UNSHIELDED CABLE FPL GENESIS 4513, BELDEN 6120UL (Up to 8,000 ft)
- A 1 PR #16 AWG TWISTED-PAIR UNSHIELDED CABLE FPL GENESIS 4511, BELDEN 6220UL (Up to 4,500 ft)
- B 1 PR #12 AWG FPL CABLE
- D 1 PR #14 AWG FPL CABLE
- E 1 PR #16 AWG FPL CABLE
- F 2c #12 AWG CABLE
- G 2c #14 AWG CABLE
- H 1 PR #16 AWG TWISTED-PAIR SHIELDED CABLE FPL
- J 1 CAT5 CABLE

|                      |                  |
|----------------------|------------------|
| REVISION 2           | DATE:            |
| REVISION 1           | DATE:            |
| REVISION 0 SUBMITTAL | DATE: 10/22/2012 |

**SYSTEM WIRING RISER**

|                      |                 |
|----------------------|-----------------|
| PROJECT NAME         | SCALE 1/4" = 1' |
| <b>Space Gallery</b> | BY: EAD         |
| Portland, MAINE      | CK BY:          |



Prepared For Tomorrow, Delivered Today  
2257 BROADWAY, SD. PORTLAND, MAINE

SAVED AS:

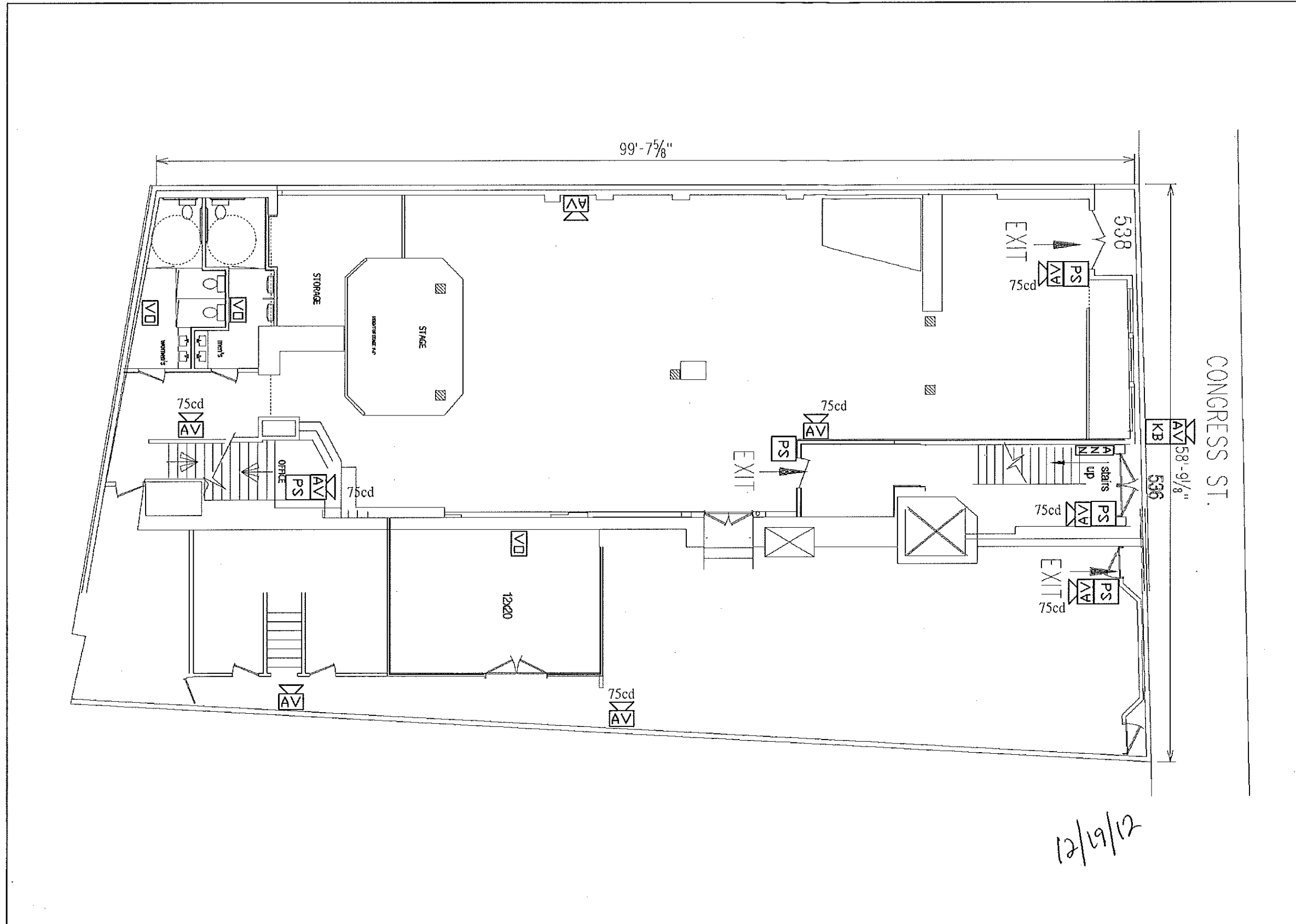

LEGEND

- 48 INCHES PS PULL STATION
- S SMOKE DETECTOR
- R HEAT DETECTOR RATE OF RISE
- F HEAT DETECTOR FIXED TEMP
- RT REMOTE TEST/INDICATOR
- DS DUCT SMOKE DETECTOR
- 80 INCHES VO VISUAL ONLY
- 80 INCHES AV AUDIO / VISUAL
- NZM 100 ZONE MODULE
- NC-100 CONTROL MODULE
- NMM MONITOR MODULE 100=4 SQUARE, 100p=minmod
- NC 100r RELAY MODULE
- STS SPRINKLER TAMPER
- SPS SPRINKLER PRESSURE
- SFS SPRINKLER FLOW
- DH DOOR HOLDER 120V AC

This drawing is a typical device layout, wiring is shown diagrammatically only. This drawing has been provided as an example ONLY. Riser does not necessarily indicate all devices and appliances. See floor plans and specification for location and quantities. The purchaser must accurately layout the initiating and notification devices in their proper zones/circuit. Note: All signal circuits have a 2.5 amp load limitation and a combined load limitation of 3.0 amps or 6.0 amps if XRM-24 is added to the panel. There can be 4 class B nac circuits or 2 class A nac circuits. REMOTE power supply has a 3.0 amp limitation per circuit and an 8.0 amp combined limitation for all 4 circuits. (see chart below for current vs. candela rating)

| Room Size | Candela Rating | Load (amps) |
|-----------|----------------|-------------|
| 20' x 20' | 15 cd          | 0.08 amps   |
| 28' x 28' | 30 cd          | 0.10 amps   |
| 45' x 45' | 75 cd          | 0.15 amps   |
| 54' x 54' | 110 cd         | 0.20 amps   |

- A 1 PR #12 AWG TWISTED-PAIR UNSHIELDED CABLE FPL GENESIS 4515, BELDEN 6020UL (Up to 10,000 ft)
- A 1 PR #14 AWG TWISTED-PAIR UNSHIELDED CABLE FPL GENESIS 4513, BELDEN 6120UL (Up to 8,000 ft)
- A 1 PR #16 AWG TWISTED-PAIR UNSHIELDED CABLE FPL GENESIS 4511, BELDEN 6220UL (Up to 4,500 ft)
- B 1 PR #12 AWG FPL CABLE
- D 1 PR #14 AWG FPL CABLE
- E 1 PR #16 AWG FPL CABLE
- F 2c #12 AWG CABLE
- G 2c #14 AWG CABLE
- H 1 PR #16 AWG TWISTED-PAIR SHIELDED CABLE FPL
- J 1 CAT5 CABLE

|                      |                  |
|----------------------|------------------|
| REVISION 2           | DATE:            |
| REVISION 1           | DATE:            |
| REVISION 0 SUBMITTAL | DATE: 10/22/2012 |

SYSTEM WIRING RISER

|  |                                      |
|--|--------------------------------------|
| PROJECT NAME<br><b>Space Gallery</b><br>Portland, MAINE                          | SCALE 3/4" = 1'<br>BY: EAD<br>CK BY: |
| <br>Prepared For Tomorrow, Delivered Today<br>2257 BROADWAY, SO. PORTLAND, MAINE | SAVED AS:                            |

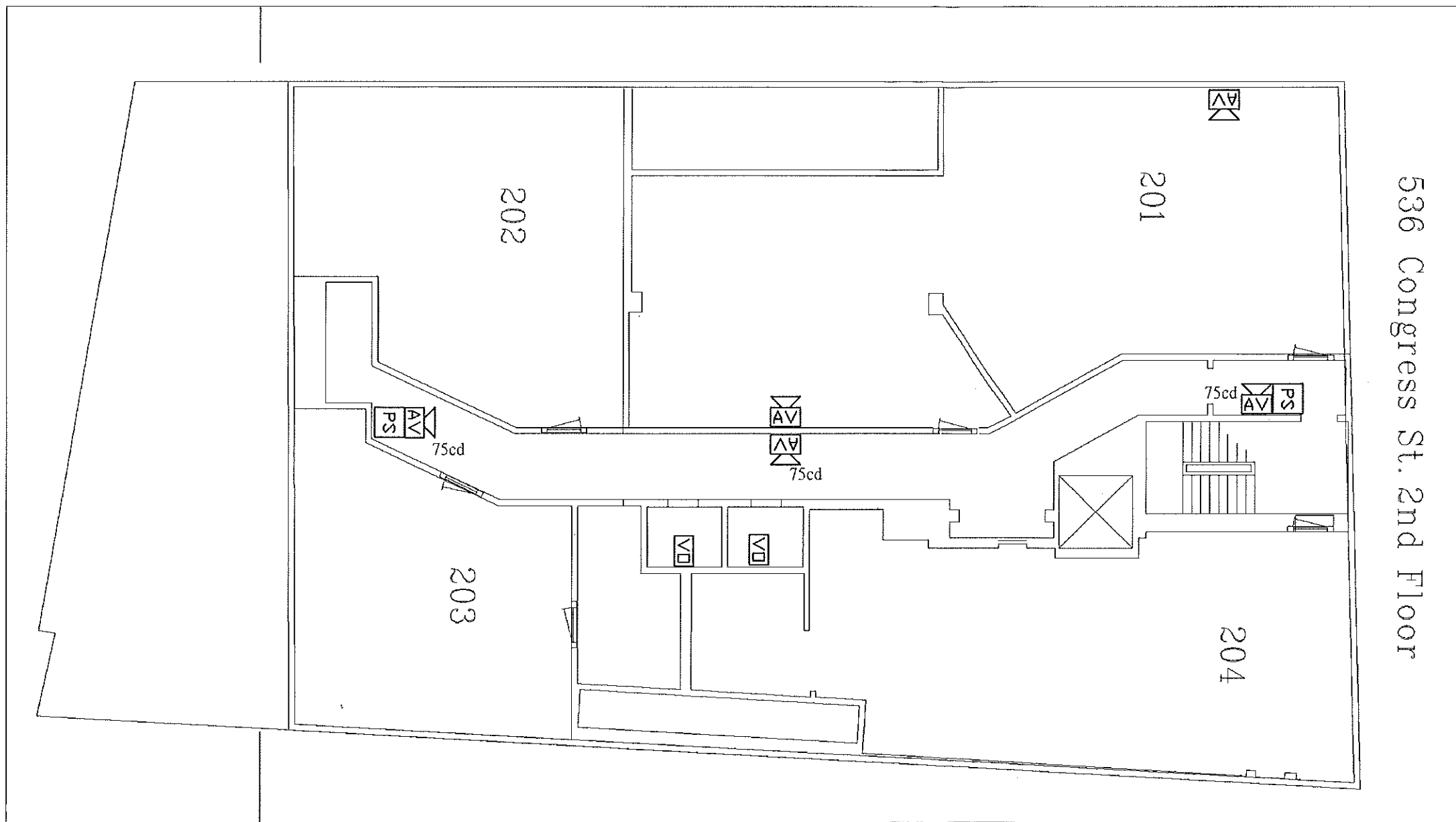

12/19/12

LEGEND

- MOUNTING HEIGHT
- 48 INCHES
  - PS PULL STATION
  - S SMOKE DETECTOR
  - R HEAT DETECTOR RATE OF RISE
  - F HEAT DETECTOR FIXED TEMP
  - RT REMOTE TEST/INDICATOR
  - DS<sup>s</sup> DUCT SMOKE DETECTOR
- 80 INCHES
  - V VISUAL ONLY
- 80 INCHES
  - AV AUDIO / VISUAL
  - NZM 100 ZONE MODULE
  - NC-100 CONTROL MODULE
  - NMM MONITOR MODULE 100=4 SQUARE, 100p=mini mod
  - NC 100r RELAY MODULE
  - STS SPRINKLER TAMPER
  - SPS SPRINKLER PRESSURE
  - SFS SPRINKLER FLOW
  - DH DOOR HOLDER 120V AC

This drawing is a typical device layout, wiring is shown diagrammatically only. This drawing has been provided as an example ONLY. Riser does not necessarily indicate all devices and appliances. See floor plans and specification for location and quantities. The purchaser must accurately layout the initiating and notification devices in their proper zones/circuit. Note: All signal circuits have a 2.5 amp load limitation and a combined load limitation of 3.0 amps or 6.0 amps if XRM-24 is added to the panel. There can be 4 class B nac circuits or 2 class A nac circuits. REMOTE power supply has a 3.0 amps limitation per circuit and an 8.0 amp combined limitation for all 4 circuits. (see chart below for current vs. candela rating)

| Room Size | Candela Rating | Load (amps) |
|-----------|----------------|-------------|
| 20' x 20' | 15 cd          | 0.08 amps   |
| 28' x 28' | 30 cd          | 0.10 amps   |
| 45' x 45' | 75 cd          | 0.15 amps   |
| 54' x 54' | 110 cd         | 0.20 amps   |

- A 1 PR #12 AWG TWISTED-PAIR UNSHIELDED CABLE FPL GENESIS 4515, BELDEN 6020UL (Up to 10,000 ft)
- A 1 PR #14 AWG TWISTED-PAIR UNSHIELDED CABLE FPL GENESIS 4513, BELDEN 6120UL (Up to 8,000 ft)
- A 1 PR #16 AWG TWISTED-PAIR UNSHIELDED CABLE FPL GENESIS 4511, BELDEN 6220UL (Up to 4,500 ft)
- B 1 PR #12 AWG FPL CABLE
- D 1 PR #14 AWG FPL CABLE
- E 1 PR #16 AWG FPL CABLE
- F 2c #12 AWG CABLE
- G 2c #14 AWG CABLE
- H 1 PR #16 AWG TWISTED-PAIR SHIELDED CABLE FPL
- J 1 CAT5 CABLE

|                      |                  |
|----------------------|------------------|
| REVISION 2           | DATE:            |
| REVISION 1           | DATE:            |
| REVISION 0 SUBMITTAL | DATE: 10/22/2012 |

SYSTEM WIRING RISER

|   |                           |
|---|---------------------------|
| PROJECT NAME<br><b>Space Gallery</b><br>Portland, MAINE   | SCALE $\frac{3}{8}" = 1'$ |
| <br>NORRIS INC<br>Prepared For Tomorrow, Delivered Today<br>2257 BROADWAY, SO. PORTLAND, MAINE | BY: <b>EAD</b>            |
|   | CK BY:                    |
| SAVED AS:   |                           |



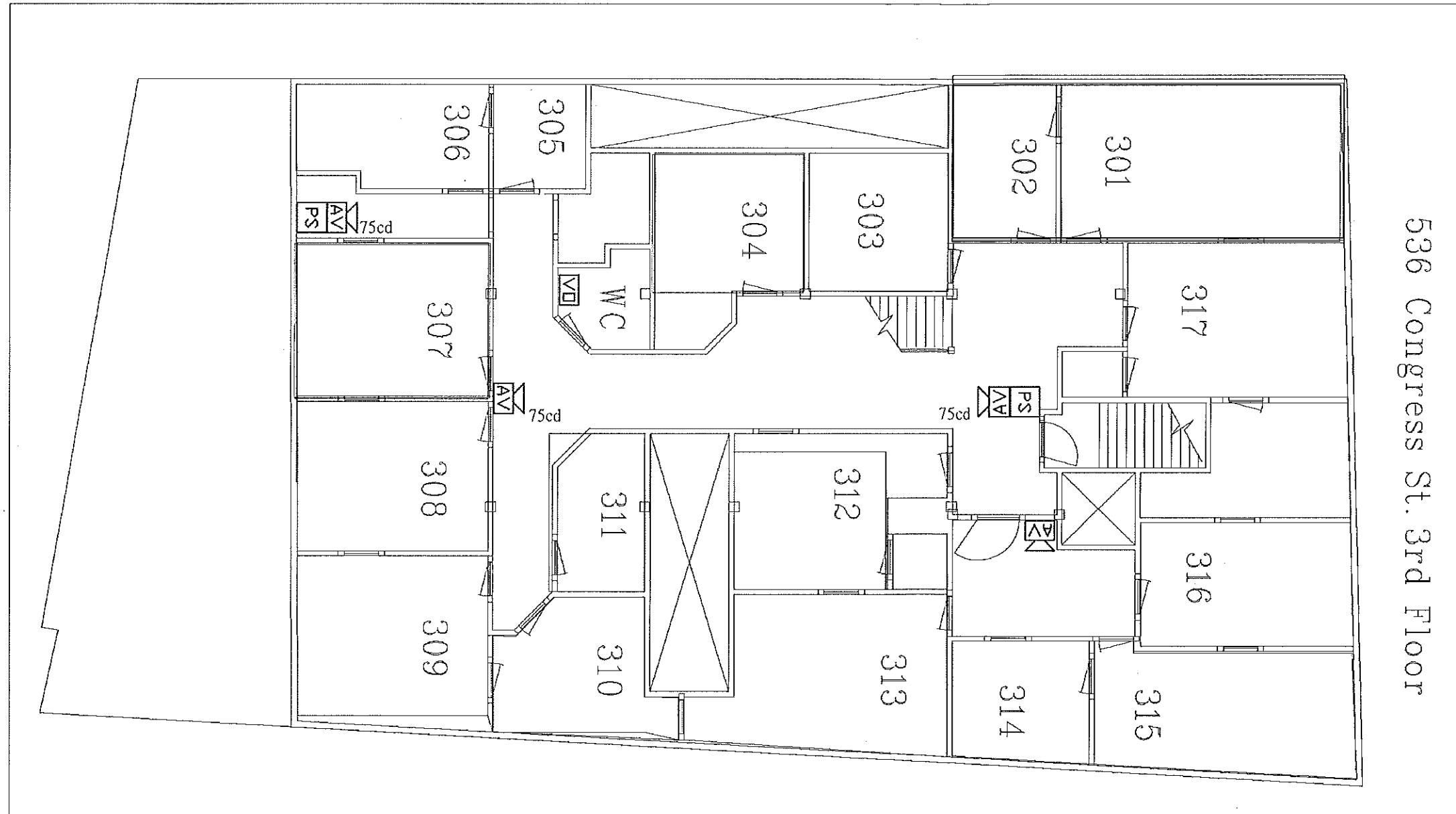

536 Congress St. 3rd Floor

12/19/12

**LEGEND**

- 48 INCHES PS PULL STATION
- S SMOKE DETECTOR
- R HEAT DETECTOR RATE OF RISE
- F HEAT DETECTOR FIXED TEMP
- RT REMOTE TEST/INDICATOR
- DS DUCT SMOKE DETECTOR
- 80 INCHES V VISUAL ONLY
- 80 INCHES AV AUDIO / VISUAL
- NZM 100 ZONE MODULE
- NC-100 CONTROL MODULE
- NMM MONITOR MODULE 100=4 SQUARE, 100p=mini mod
- NC 100r RELAY MODULE
- STS SPRINKLER TAMPER
- SPS SPRINKLER PRESSURE
- SFS SPRINKLER FLOW
- DH DOOR HOLDER 120V AC

This drawing is a typical device layout, wiring is shown diagrammatically only. This drawing has been provided as an example ONLY. Riser does not necessarily indicate all devices and appliances. See floor plans and specification for location and quantities. The purchaser must accurately layout the initiating and notification devices in their proper zones/circuit. Note: All signal circuits have a 2.5 amp load limitation and a combined load limitation of 3.0 amps or 6.0 amps if XRM-24 is added to the panel. There can be 4 class B nac circuits or 2 class A nac circuits. REMOTE power supply has a 3.0 amp limitation per circuit and an 8.0 amp combined limitation for all 4 circuits. (see chart below for current vs. candela rating)

| Room Size | Candela Rating | Load (amps) |
|-----------|----------------|-------------|
| 20' x 20' | 15 cd          | 0.08 amps   |
| 28' x 28' | 30 cd          | 0.10 amps   |
| 45' x 45' | 75 cd          | 0.15 amps   |
| 54' x 54' | 110 cd         | 0.20 amps   |

- A 1 PR #12 AWG TWISTED-PAIR UNSHIELDED CABLE FPL GENESIS 4515, BELDEN 6020UL (Up to 10,000 ft)
- A 1 PR #14 AWG TWISTED-PAIR UNSHIELDED CABLE FPL GENESIS 4513, BELDEN 6120UL (Up to 8,000 ft)
- A 1 PR #16 AWG TWISTED-PAIR UNSHIELDED CABLE FPL GENESIS 4511, BELDEN 6220UL (Up to 4,500 ft)
- B 1 PR #12 AWG FPL CABLE
- D 1 PR #14 AWG FPL CABLE
- E 1 PR #16 AWG FPL CABLE
- F 2c #12 AWG CABLE
- G 2c #14 AWG CABLE
- H 1 PR #16 AWG TWISTED-PAIR SHIELDED CABLE FPL
- J 1 CAT5 CABLE

|                      |                  |
|----------------------|------------------|
| REVISION 2           | DATE:            |
| REVISION 1           | DATE:            |
| REVISION 0 SUBMITTAL | DATE: 10/22/2012 |

**SYSTEM WIRING RISER**

|   |                                       |
|---|---------------------------------------|
| PROJECT NAME<br><b>Space Gallery</b><br>Portland, MAINE   | SCALE $\frac{3}{8}" = 1'$             |
| <b>NORRIS INC</b><br>Prepared For Tomorrow, Delivered Today<br>2257 BROADWAY, SO. PORTLAND, MAINE | BY: <b>ZAD</b><br>CK BY:<br>SAVED AS: |

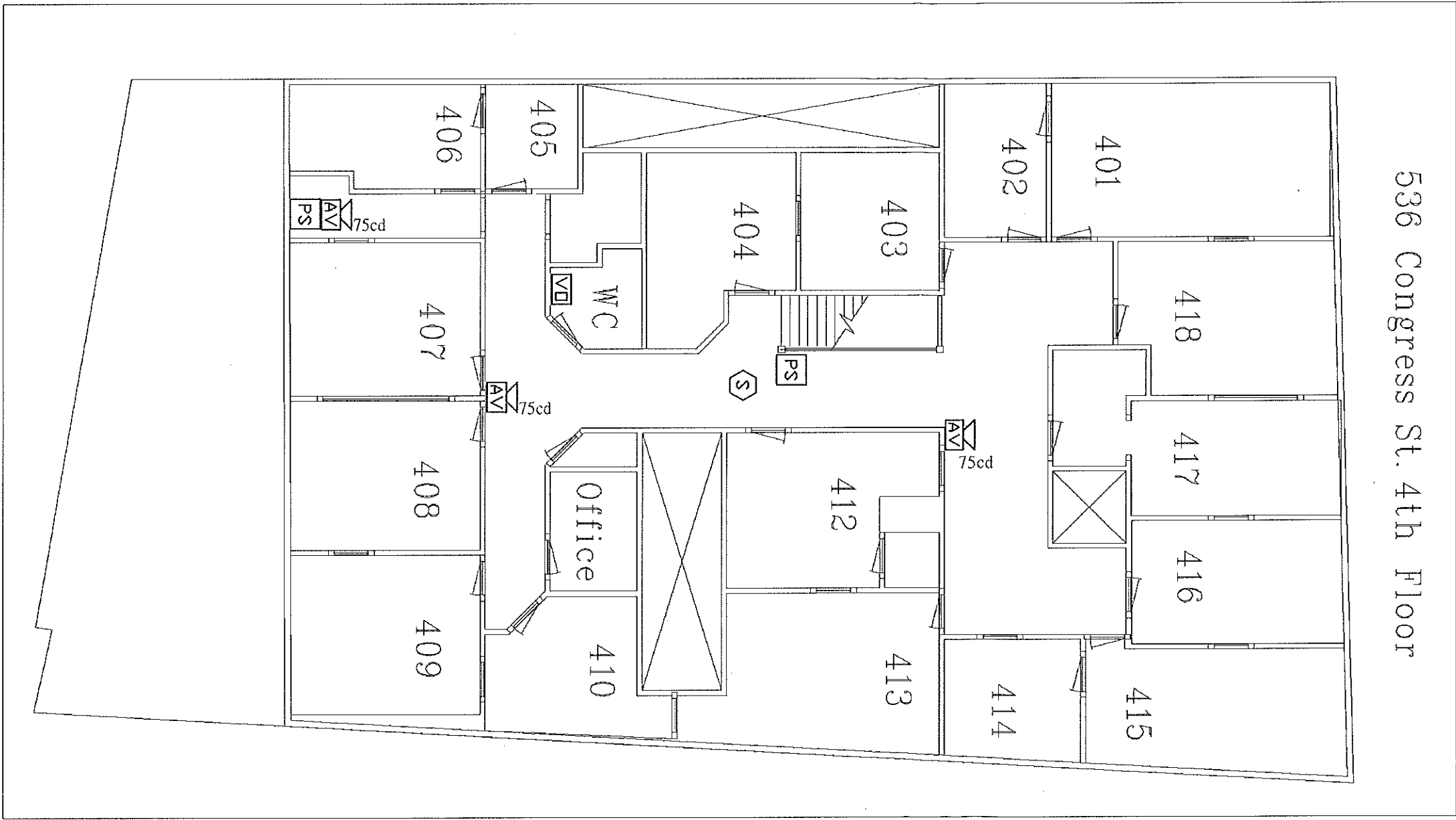

536 Congress St. 4th Floor

**LEGEND**

- MOUNTING HEIGHT
- 48 INCHES
  - PS PULL STATION
  - S SMOKE DETECTOR
  - R HEAT DETECTOR RATE OF RISE
  - F HEAT DETECTOR FIXED TEMP
  - RT REMOTE TEST/INDICATOR
  - DS DUCT SMOKE DETECTOR
- 80 INCHES
  - VO VISUAL ONLY
  - AV AUDIO / VISUAL
- 80 INCHES
  - NZM 100 ZONE MODULE
  - NC-100 CONTROL MODULE
  - NMM 100=4 SQUARE, 100p=nlmod MONITOR MODULE
  - NC 100r RELAY MODULE
  - STS SPRINKLER TAMPER
  - SPS SPRINKLER PRESSURE
  - SFS SPRINKLER FLOW
  - DH DOOR HOLDER 120V AC

This drawing is a typical device layout, wiring is shown diagrammatically only. This drawing has been provided as an example ONLY. Riser does not necessarily indicate all devices and appliances. See floor plans and specification for location and quantities. The purchaser must accurately layout the initiating and notification devices in their proper zones/circuit. Note: All signal circuits have a 2.5 amp load limitation and a combined load limitation of 3.0 amps or 6.0 amps if XRM-24 is added to the panel. There can be 4 class B nac circuits or 2 class A nac circuits. REMOTE power supply has a 3.0 amp limitation per circuit and an 8.0 amp combined limitation for all 4 circuits. (see chart below for current vs. candela rating)

| Room Size | Candela Rating | Load (amps) |
|-----------|----------------|-------------|
| 20' x 20' | 15 cd          | 0.08 amps   |
| 28' x 28' | 30 cd          | 0.10 amps   |
| 45' x 45' | 75 cd          | 0.15 amps   |
| 54' x 54' | 110 cd         | 0.20 amps   |

- A 1 PR #12 AWG TWISTED-PAIR UNSHIELDED CABLE FPL GENESIS 4515, BELDEN 6020UL (Up to 10,000 ft)
- A 1 PR #14 AWG TWISTED-PAIR UNSHIELDED CABLE FPL GENESIS 4513, BELDEN 6120UL (Up to 8,000 ft)
- A 1 PR #16 AWG TWISTED-PAIR UNSHIELDED CABLE FPL GENESIS 4511, BELDEN 6220UL (Up to 4,500 ft)
- B 1 PR #12 AWG FPL CABLE
- D 1 PR #14 AWG FPL CABLE
- E 1 PR #16 AWG FPL CABLE
- F 2c #12 AWG CABLE
- G 2c #14 AWG CABLE
- H 1 PR #16 AWG TWISTED-PAIR SHIELDED CABLE FPL
- J 1 CAT5 CABLE

|                      |                  |
|----------------------|------------------|
| REVISION 2           | DATE:            |
| REVISION 1           | DATE:            |
| REVISION 0 SUBMITTAL | DATE: 10/22/2012 |

**SYSTEM WIRING RISER**

|   |                            |
|---|----------------------------|
| PROJECT NAME<br><b>Space Gallery</b><br>Portland, MAINE | SCALE $\frac{3}{8}'' = 1'$ |
|   | BY: <b>EAD</b>             |
|   | CK BY:                     |

  
**NORRIS INC**  
 Prepared For Tomorrow, Delivered Today  
 2257 BROADWAY, SO. PORTLAND, MAINE

SAVED AS:

Important! Securing Screw MUST be installed in top of Device on Exceder series HSR and STR Audio visuals.

Important! Wiring connections must have correct polarity.

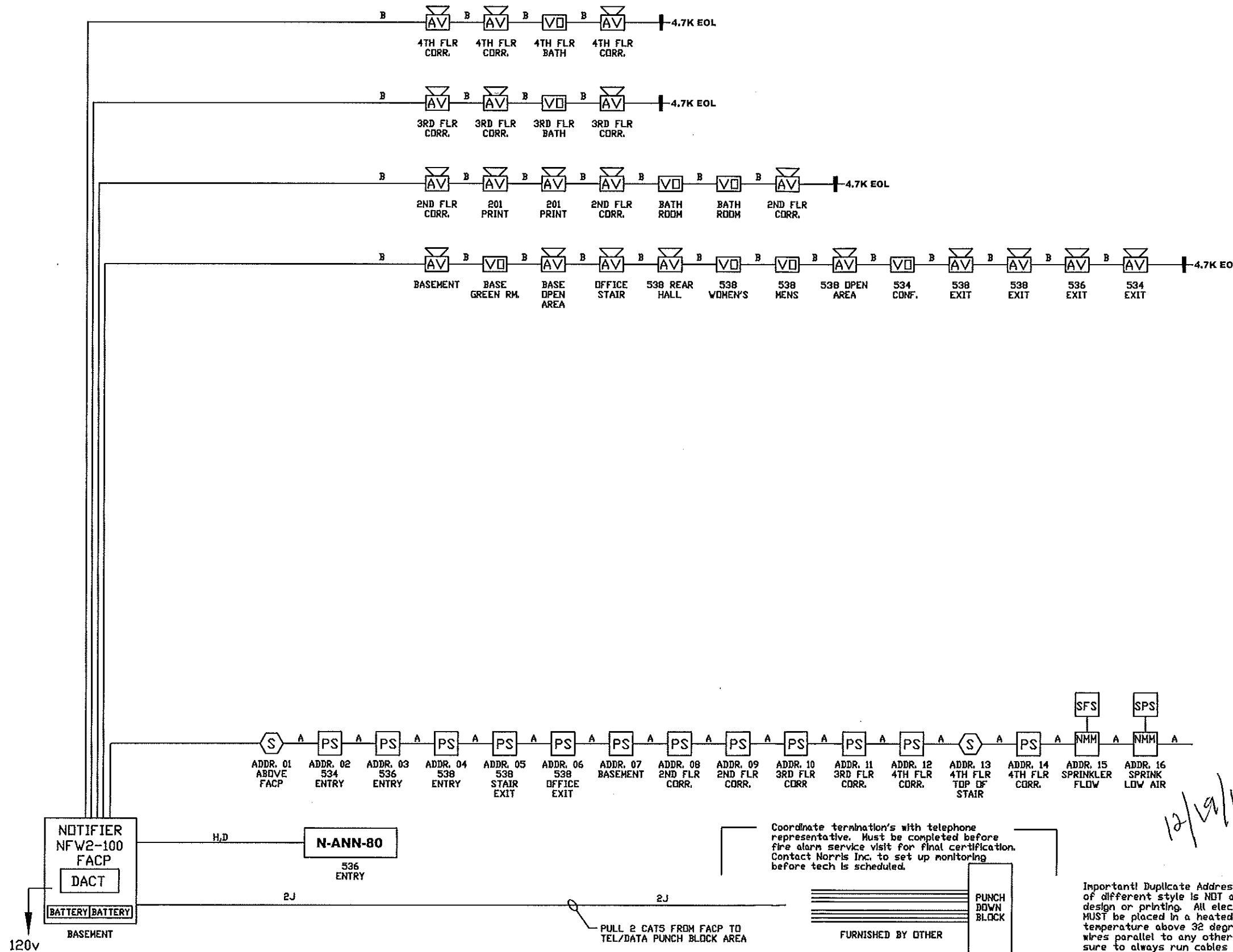

LEGEND

- MOUNTING HEIGHT
- 48 INCHES
  - PS PULL STATION
  - S SMOKE DETECTOR
  - R HEAT DETECTOR RATE OF RISE
  - F HEAT DETECTOR FIXED TEMP
  - RT REMOTE TEST/INDICATOR
  - DS DUCT SMOKE DETECTOR
- 80 INCHES
  - VO VISUAL ONLY
  - AV AUDIO / VISUAL
- 80 INCHES
  - NZM ZONE MODULE
  - NC-100 CONTROL MODULE
  - NMM MONITOR MODULE 100=4 SQUARE, 100p=nhlnod
  - NC-100r RELAY MODULE
  - STS SPRINKLER TAMPER
  - SPS SPRINKLER PRESSURE
  - SFS SPRINKLER FLOW
  - DH DOOR HOLDER 120V AC

This drawing is a typical device layout, wiring is shown diagrammatically only. This drawing has been provided as an example ONLY. Riser does not necessarily indicate all devices and appliances. See floor plans and specification for location and quantities. The purchaser must accurately layout the initiating and notification devices in their proper zones/circuit. Note: All signal circuits have a 2.5 amp load limitation and a combined load limitation of 3.0 amps or 6.0 amps if XRM-24 is added to the panel. There can be 4 class B nac circuits or 2 class A nac circuits. REMOTE power supply has a 3.0 amps limitation per circuit and an 8.0 amp combined limitation for all 4 circuits. (see chart below for current vs. candela rating)

| Room Size | Candela Rating | Load (amps) |
|-----------|----------------|-------------|
| 20' x 20' | 15 cd          | 0.08 amps   |
| 28' x 28' | 30 cd          | 0.10 amps   |
| 45' x 45' | 75 cd          | 0.15 amps   |
| 54' x 54' | 110 cd         | 0.20 amps   |

- A 1 PR #12 AWG TWISTED-PAIR UNSHIELDED CABLE FPL GENESIS 4515, BELDEN 6020UL (Up to 10,000 ft)
- A 1 PR #14 AWG TWISTED-PAIR UNSHIELDED CABLE FPL GENESIS 4513, BELDEN 6120UL (Up to 8,000 ft)
- A 1 PR #16 AWG TWISTED-PAIR UNSHIELDED CABLE FPL GENESIS 4511, BELDEN 6220UL (Up to 4,500 ft)
- B 1 PR #12 AWG FPL CABLE
- D 1 PR #14 AWG FPL CABLE
- E 1 PR #16 AWG FPL CABLE
- F 2c #12 AWG CABLE
- G 2c #14 AWG CABLE
- H 1 PR #16 AWG TWISTED-PAIR SHIELDED CABLE FPL
- J 1 CAT5 CABLE

|                      |                  |
|----------------------|------------------|
| REVISION 2           | DATE:            |
| REVISION 1           | DATE:            |
| REVISION 0 SUBMITTAL | DATE: 10/22/2012 |

SYSTEM WIRING RISER

|   |  |                             |
|---|--|-----------------------------|
| PROJECT NAME<br><b>Space Gallery</b><br>Portland, MAINE                           |  | SCALE NTS<br>BY: <b>EAD</b> |
| <br>Prepared For Tomorrow, Delivered Today<br>2257 BROADWAY, S.D. PORTLAND, MAINE |  | CK BY:                      |
|   |  | SAVED AS:                   |

Coordinate terminations with telephone representative. Must be completed before fire alarm service visit for final certification. Contact Norris Inc. to set up monitoring before tech is scheduled.

Important! Duplicate Addresses on devices of different style is NOT an error in design or printing. All electronic devices MUST be placed in a heated room with temperature above 32 degrees. Never run wires parallel to any other wiring. Make sure to always run cables in separate raceways. Fire alarm wiring can emit noise that may affect other devices. Shielded cable can be used if cable is run near sensitive equipment

12/19/12

536 Congress St. 4th Floor

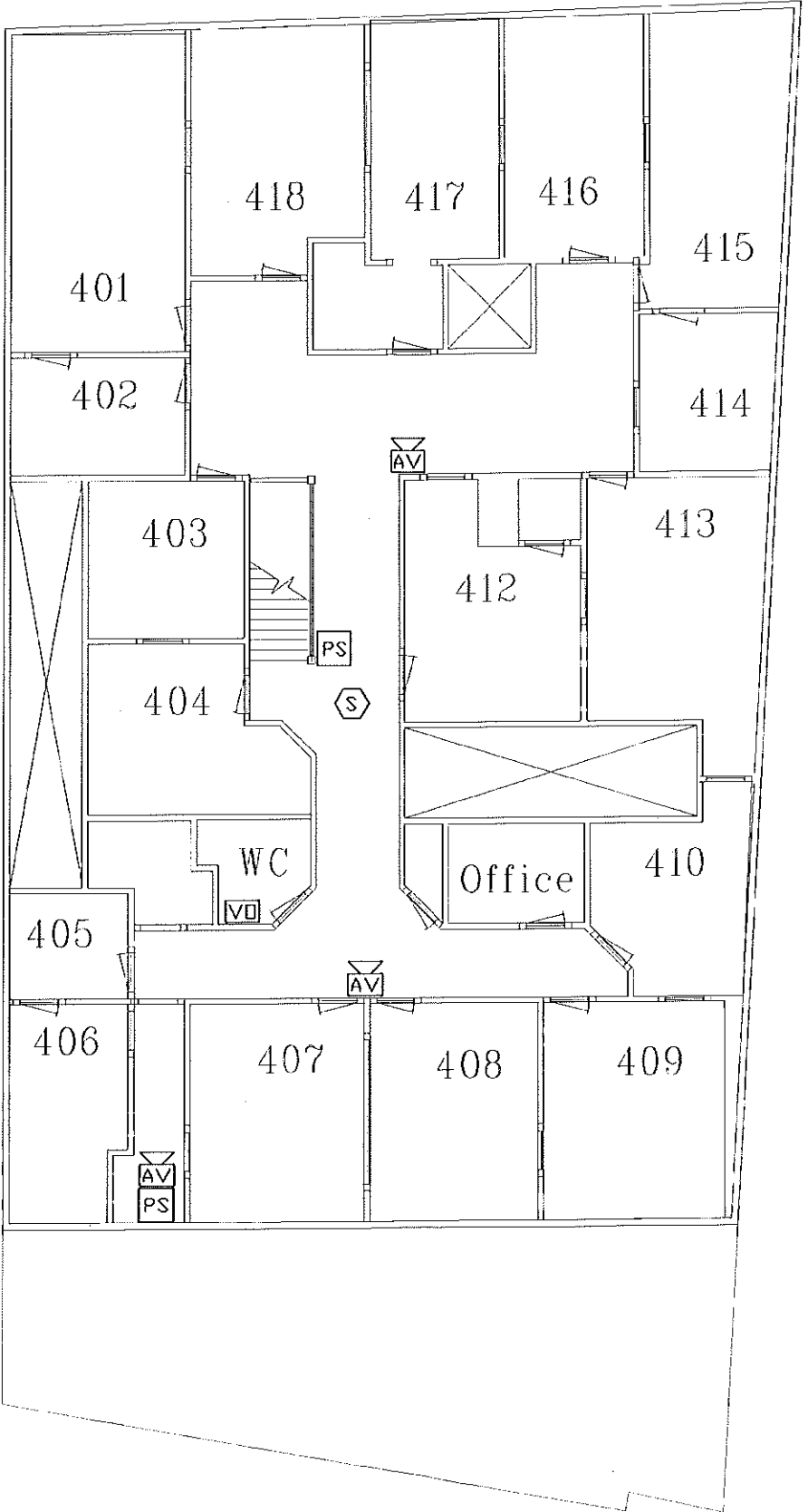

536 Congress St. 3rd Floor

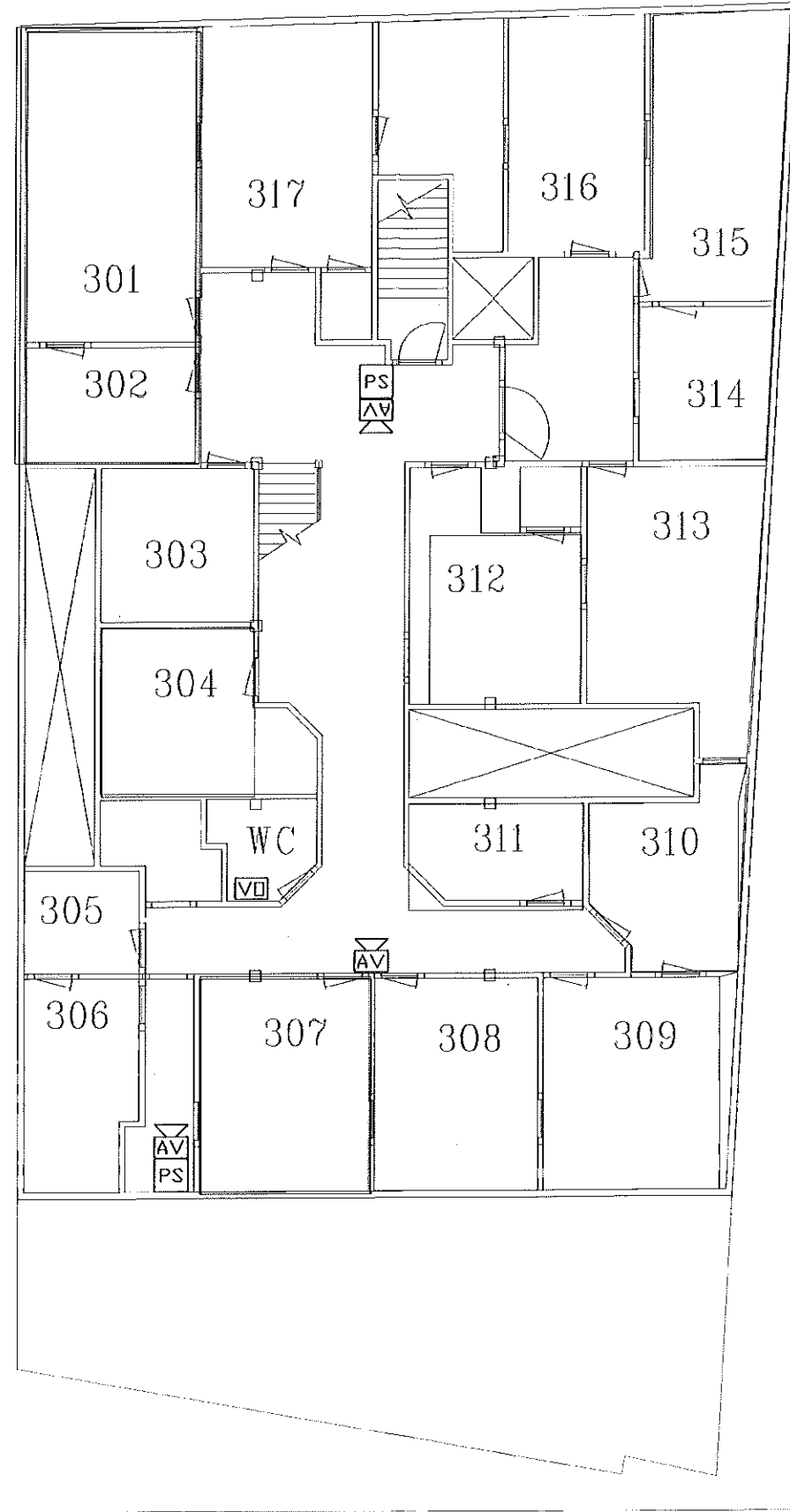

536 Congress St. 2nd Floor

