



COASTAL ARCHITECTS, P.A.

REVISIONS

© COASTAL ARCHITECTURE LLC RESERVES THEIR COMMON LAW COPYRIGHT AND OTHER PROPERTY RIGHTS IN THESE PLANS. THESE PLANS ARE NOT TO BE REPRODUCED, CHANGED OR COPIED IN ANY MANNER WITHOUT FIRST OBTAINING THE EXPRESS WRITTEN PERMISSION AND CONSENT OF © COASTAL ARCHITECTURE LLC. NOR ARE THEY TO BE ASSIGNED TO ANY THIRD PARTY WITHOUT OBTAINING SAID PERMISSION AND CONSENT.

ISSUE

15 JULY '16 PROGRESS

19 JULY '16 PROGRESS

22 JULY '16 BLDG PERMIT

PROJECT:

ORANGE THEORY FITNESS CENTER
Portland, Maine

PROJECT ADDRESS:
195 KENNEBEC STREET
PORTLAND, MAINE 04101

OWNERS ADDRESS:
DWAYNE DUPREY
6 CRESTWOOD DRIVE
HUDSON, NH 03051

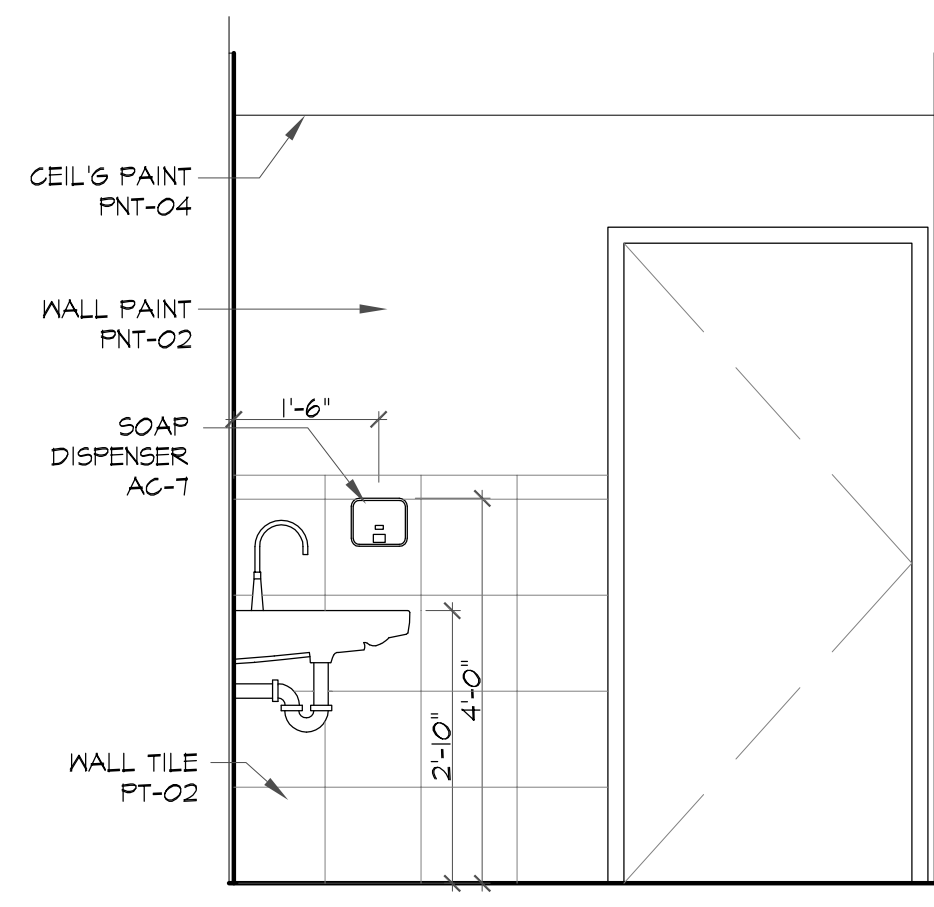

6

HCWC #1 ELEVATIONS

SCALE: 1/4" = 1'-0"

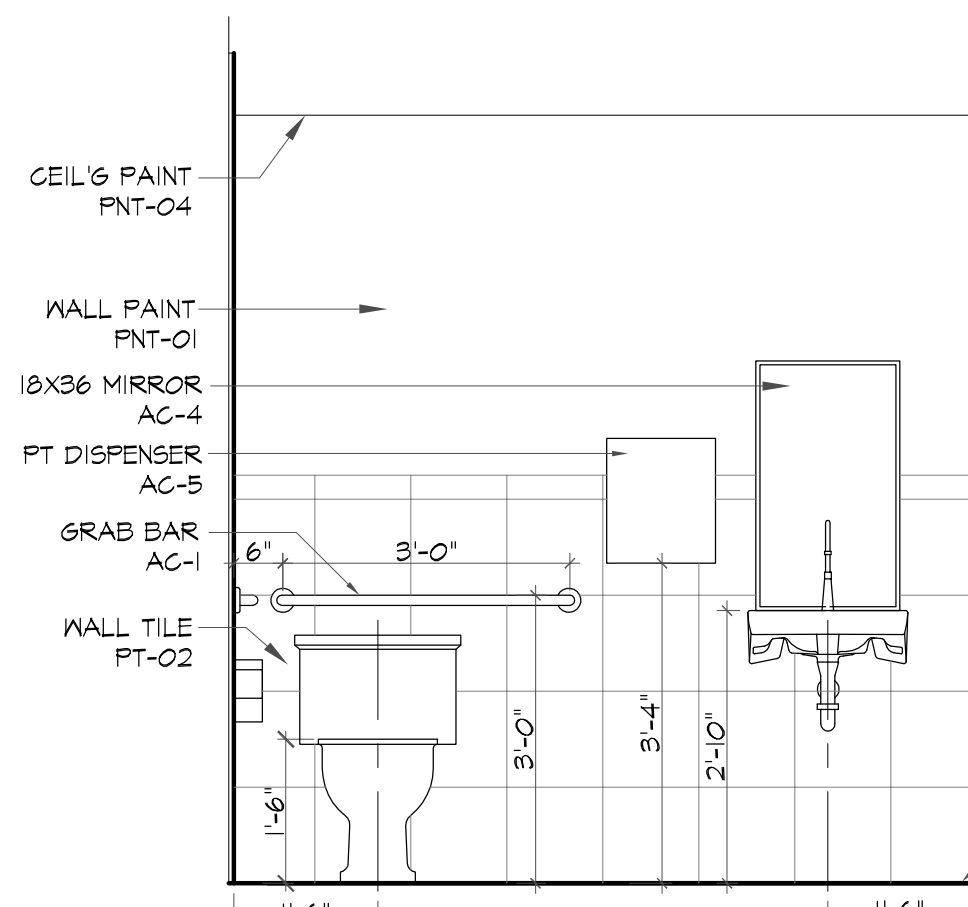

5

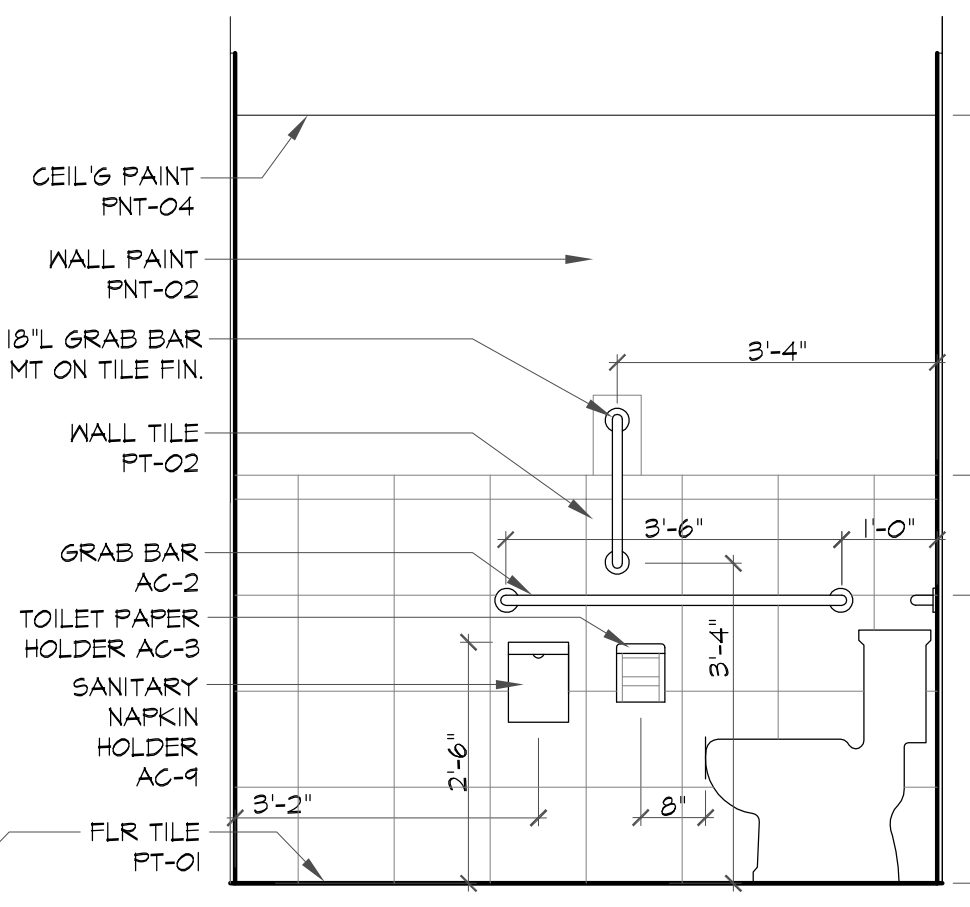

4

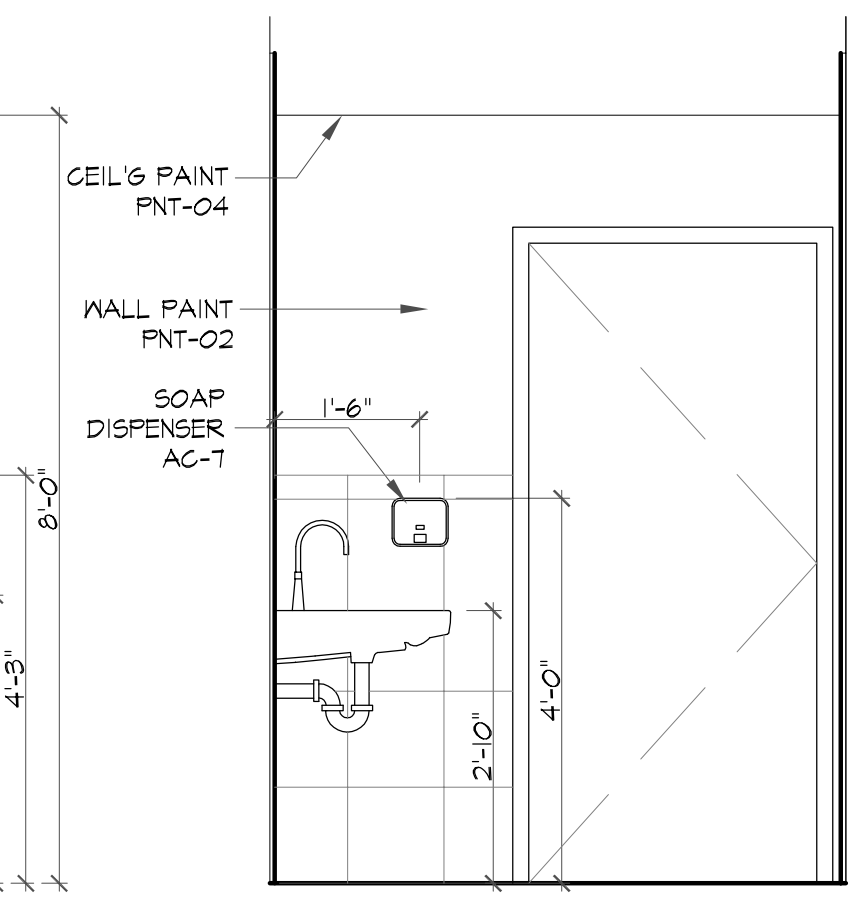

3

HCWC #2 ELEVATIONS

SCALE: 1/4" = 1'-0"

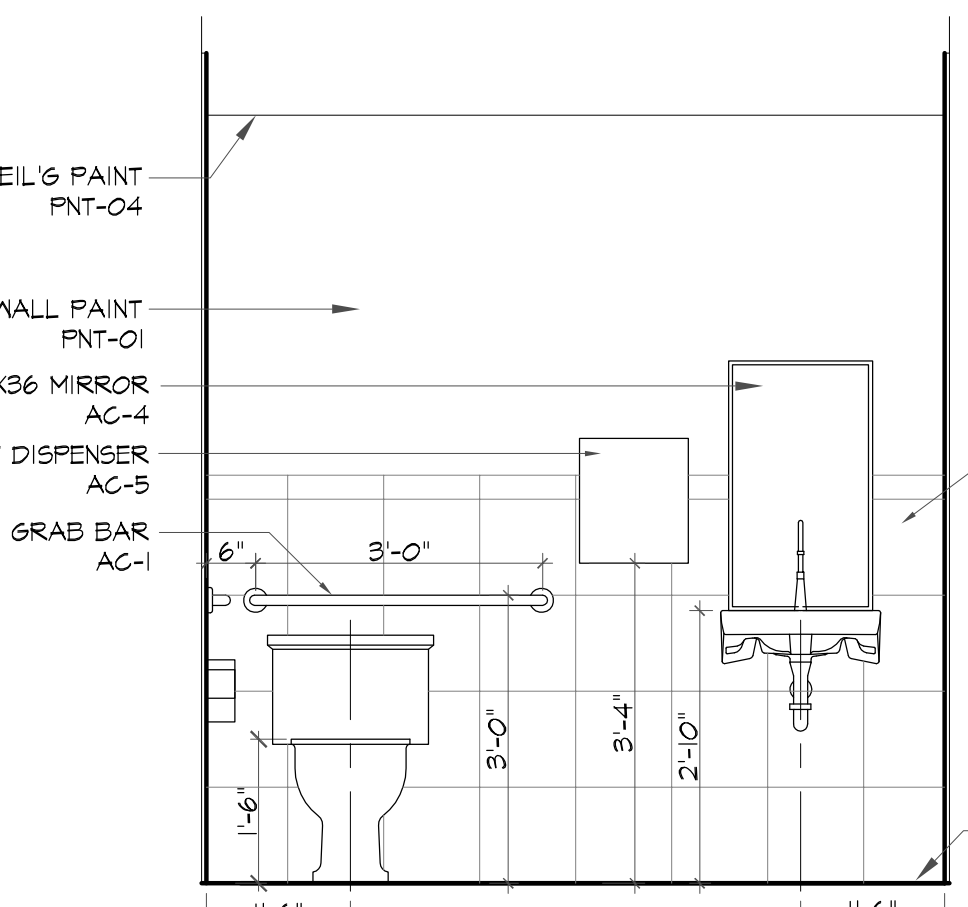

2

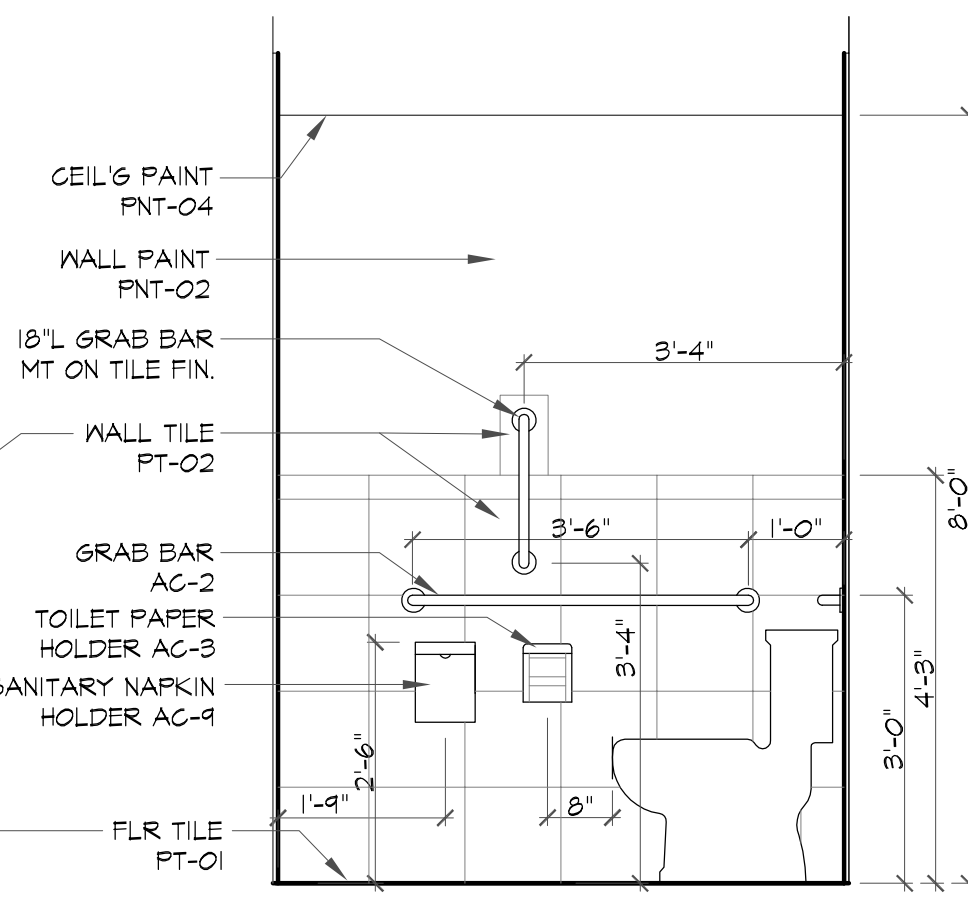

1

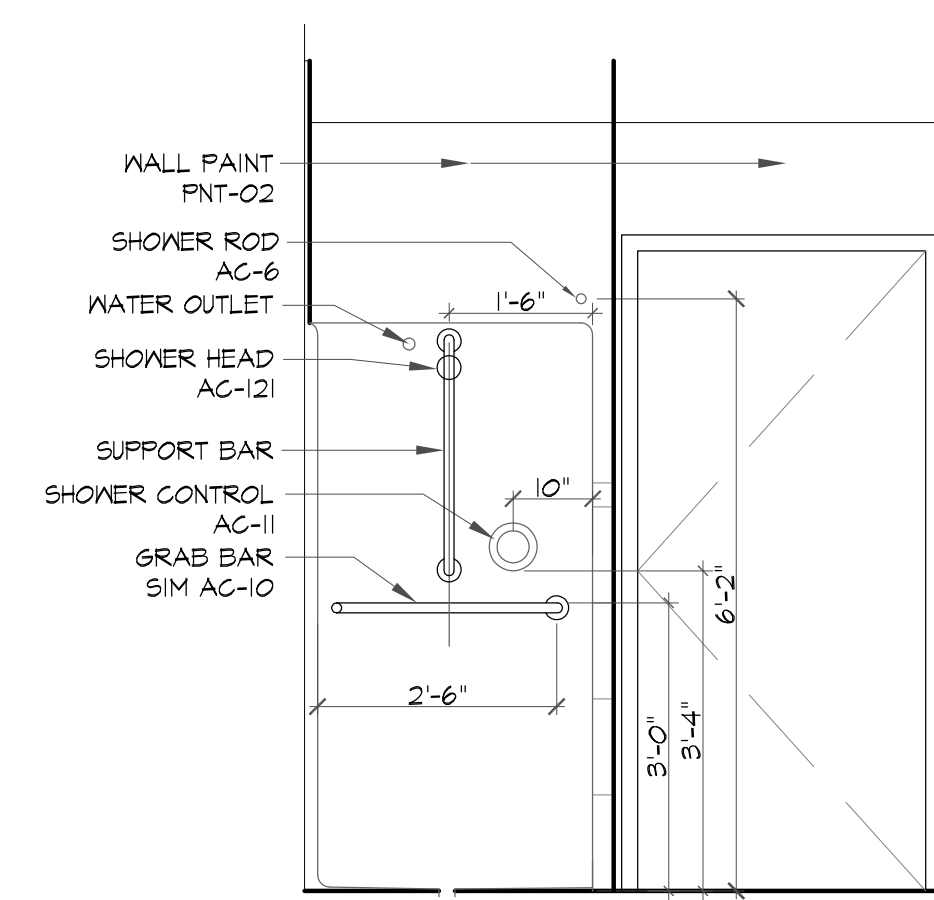

12

H.C. SHOWER ELEVATIONS

SCALE: 1/4" = 1'-0"

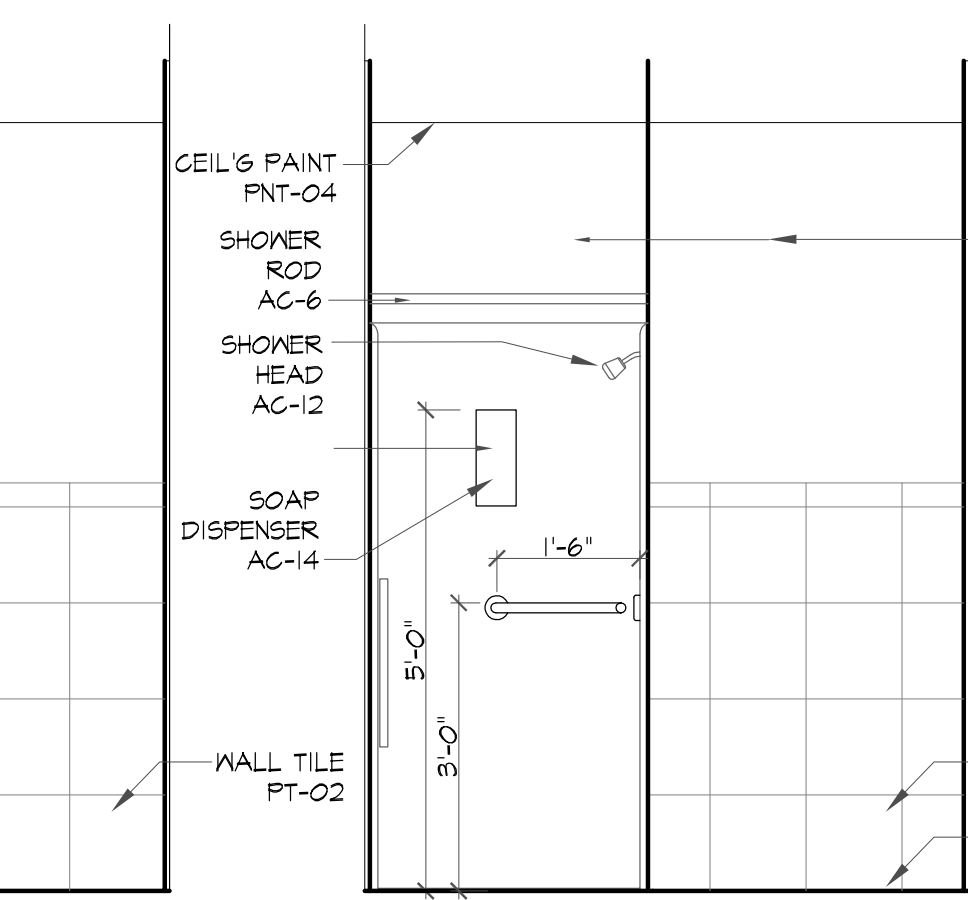

11

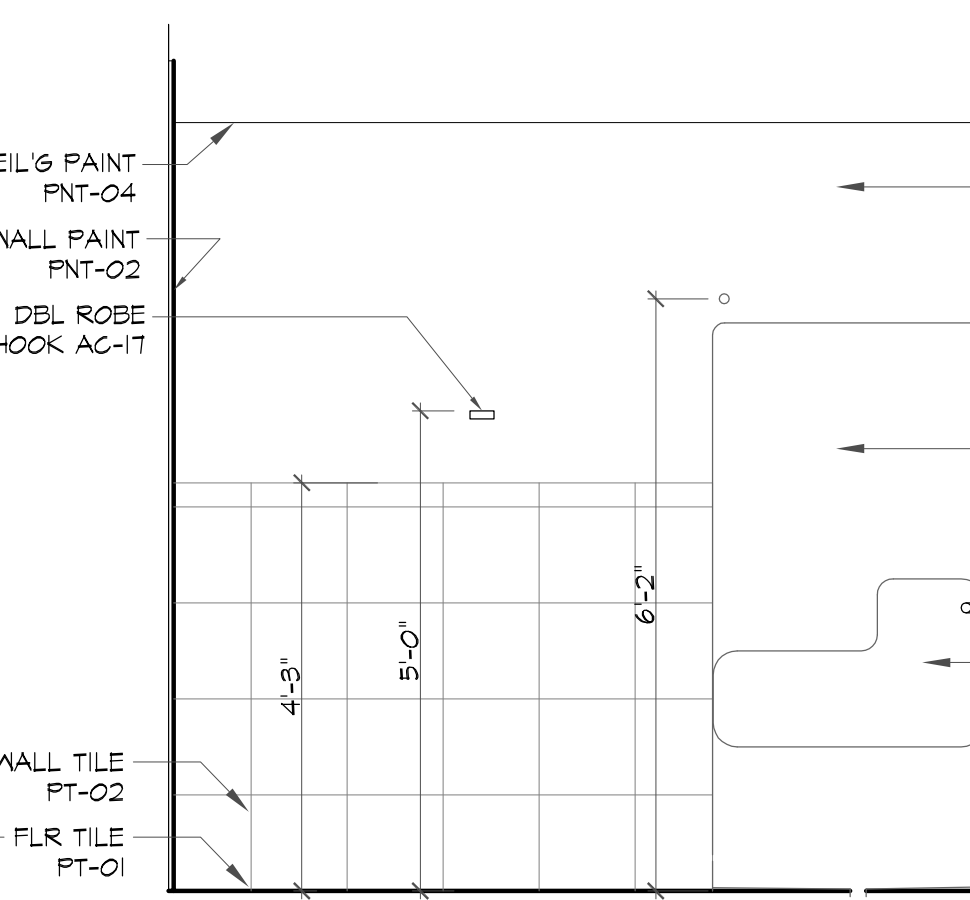

10

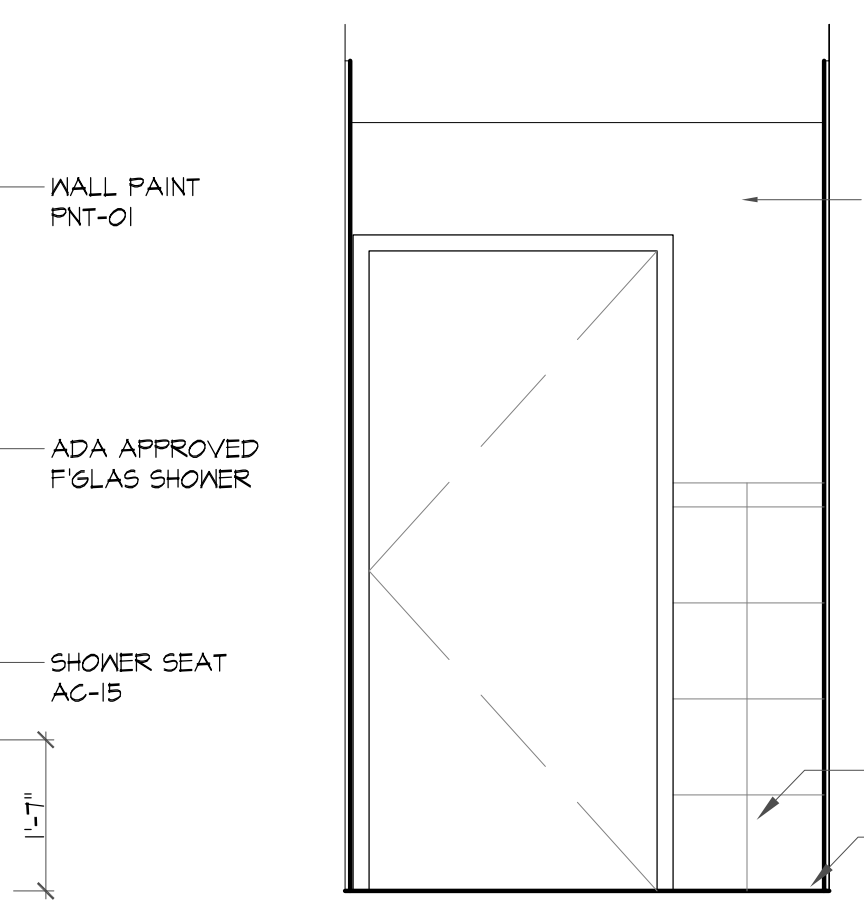

9

SHOWER ELEVATIONS

SCALE: 1/4" = 1'-0"

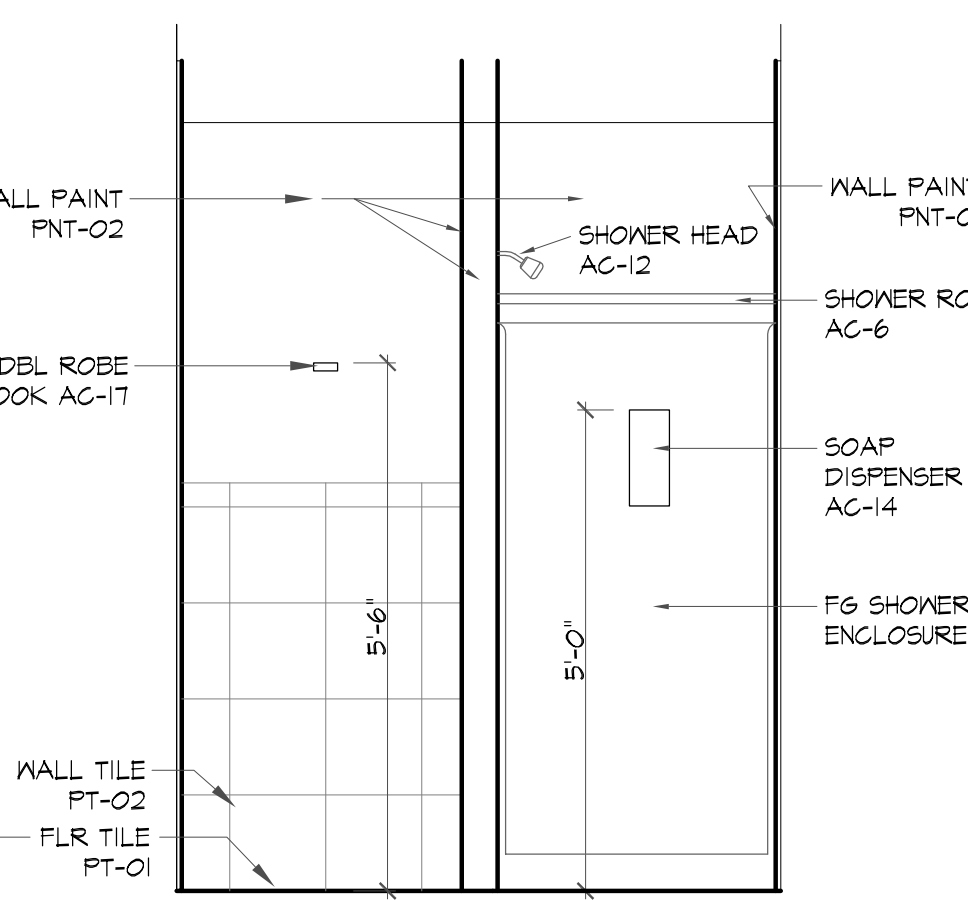

8

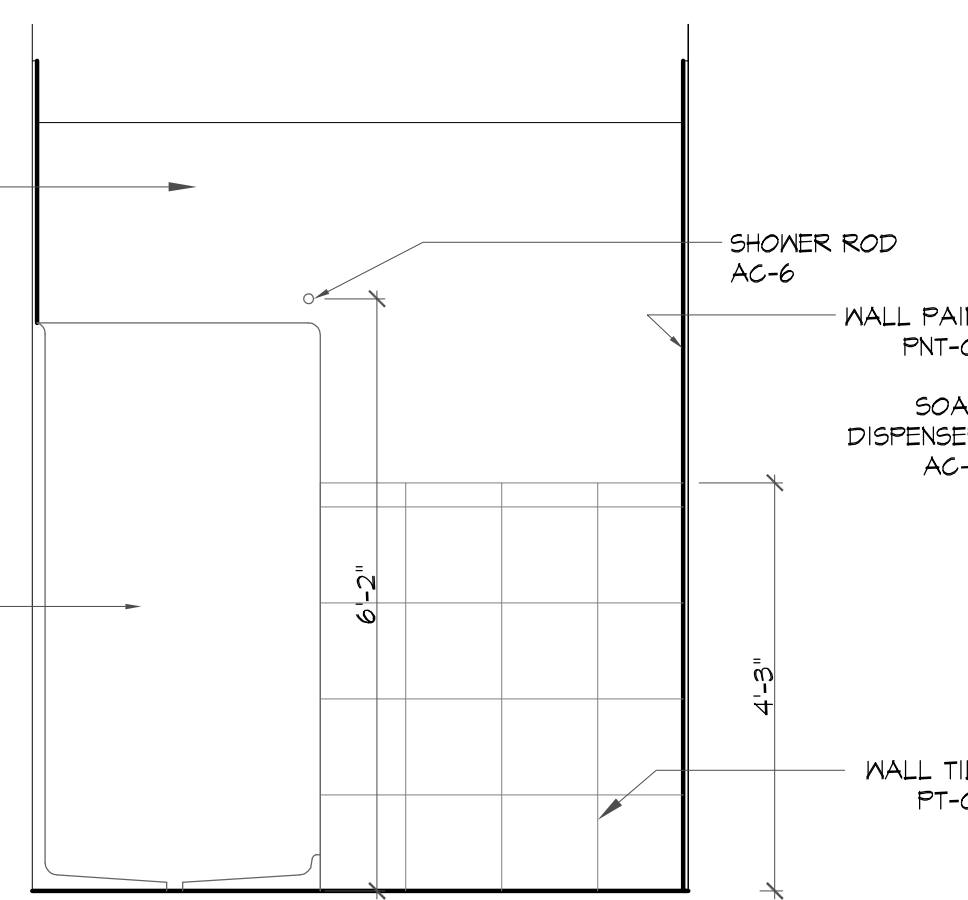

7

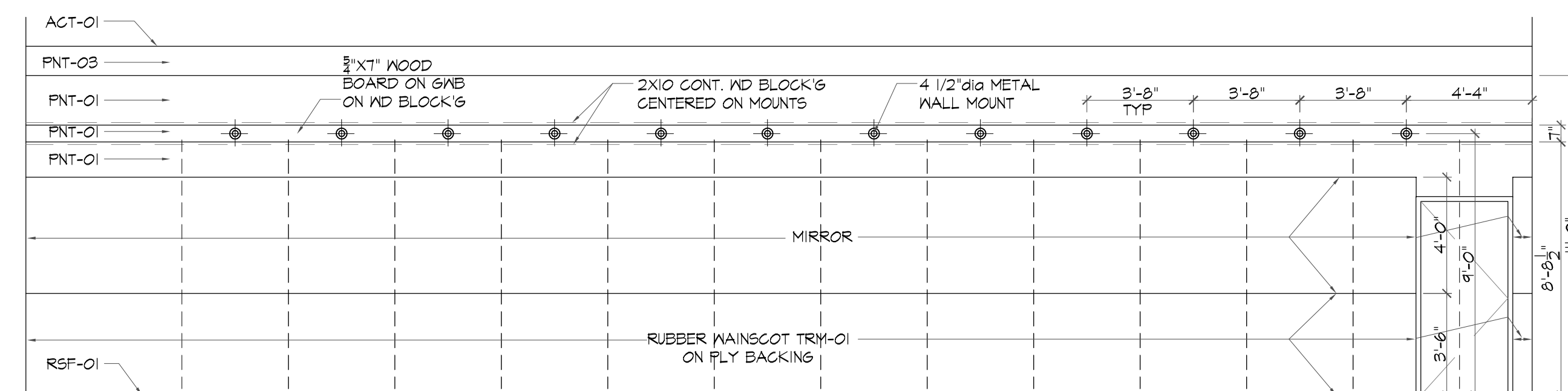

16

TRX WALL ELEV

SCALE: 1/4" = 1'-0"

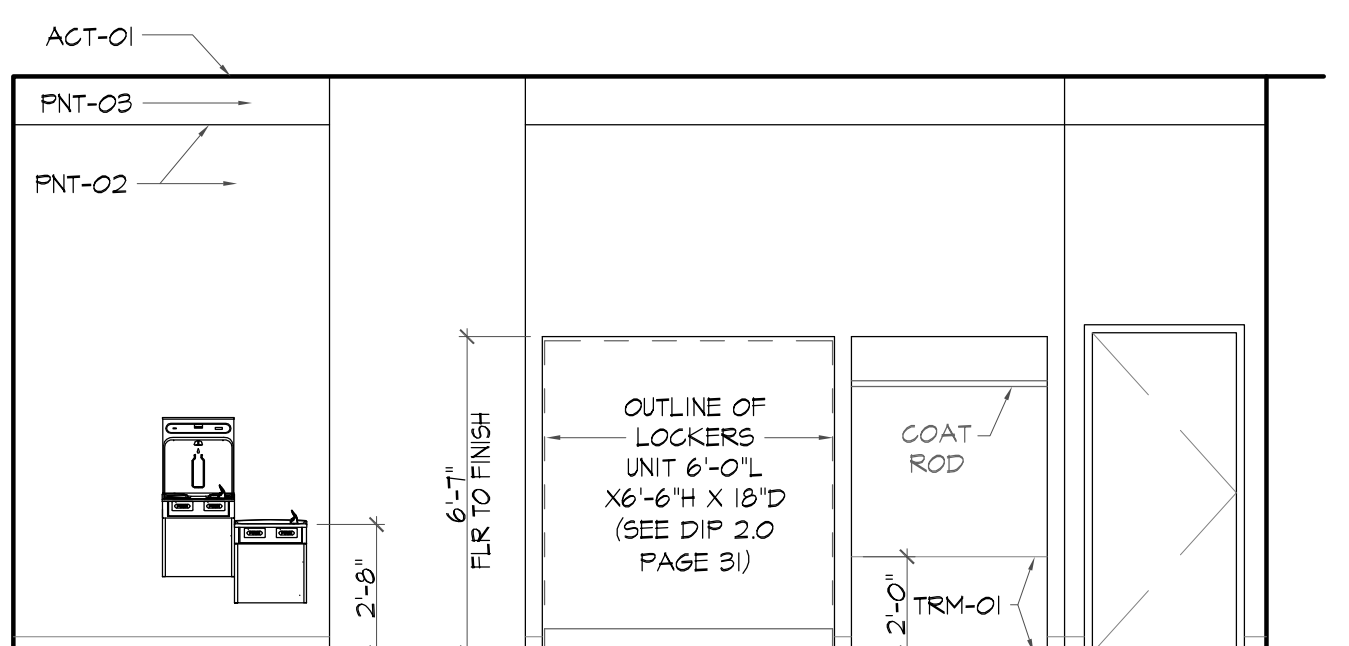

15

CORRIDOR #1 ELEV

SCALE: 1/4" = 1'-0"

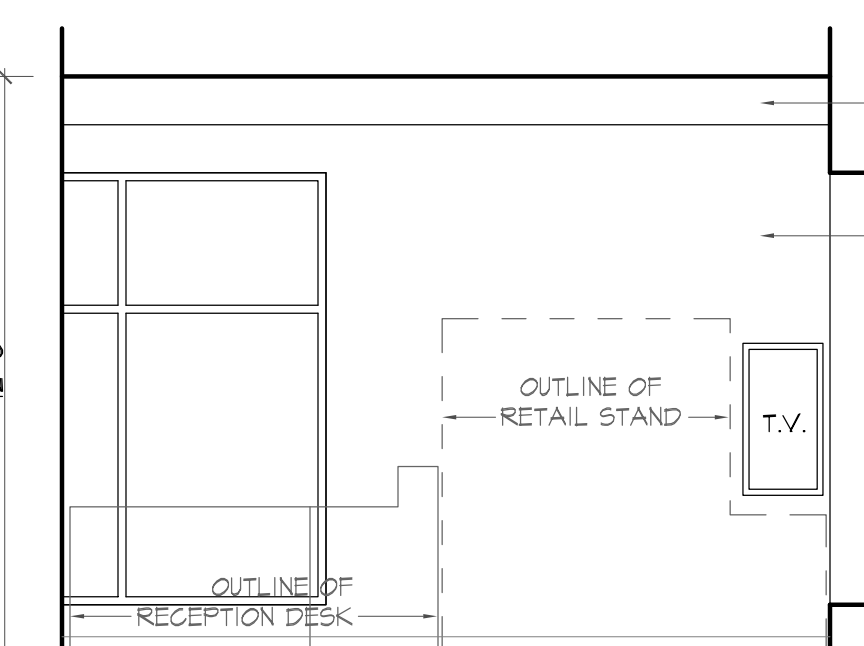

14

RETAIL WALL ELEV

SCALE: 1/4" = 1'-0"

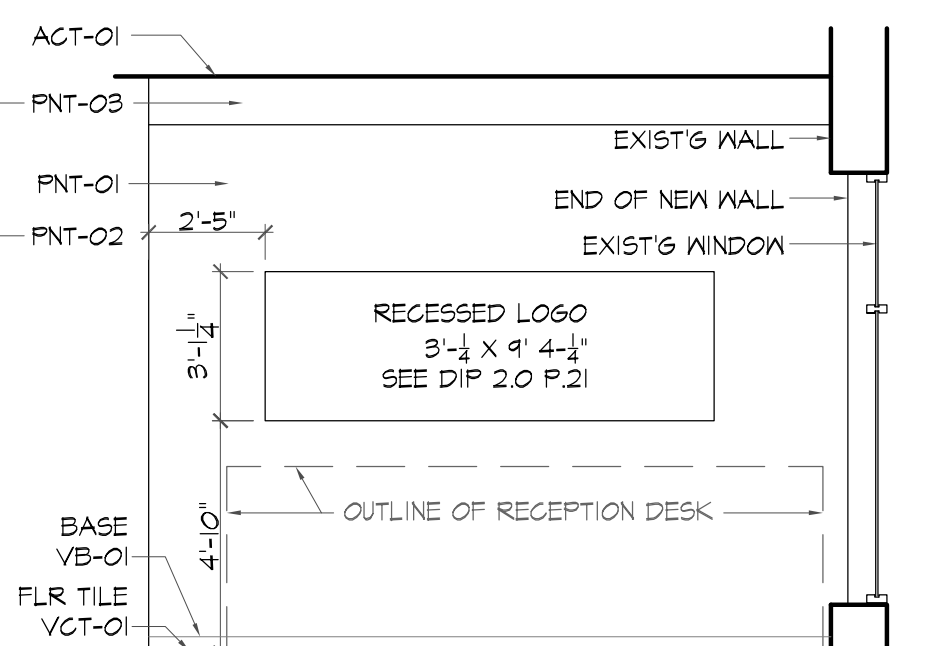

13

RECEPTION ELEV

SCALE: 1/4" = 1'-0"

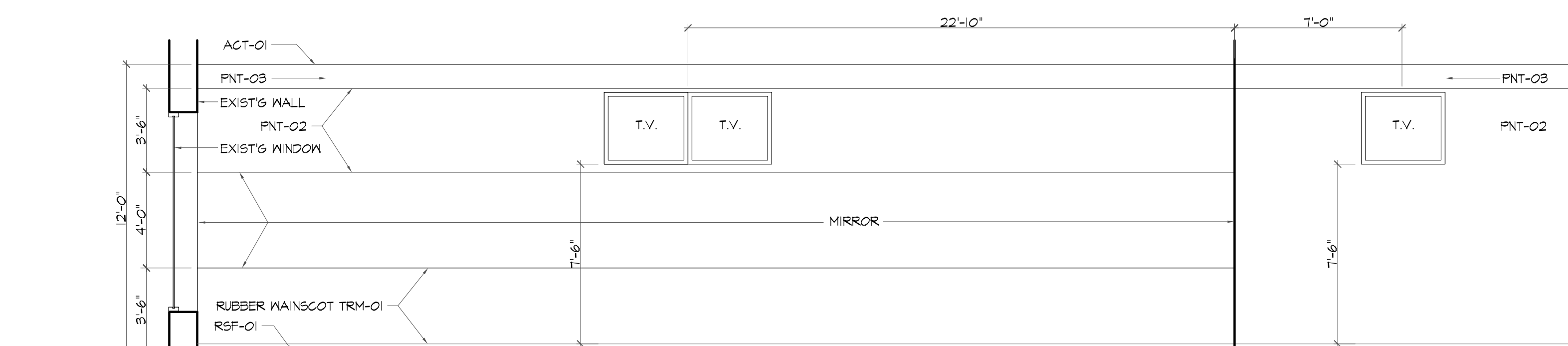

20

TREADMILL WALL ELEV

SCALE: 1/4" = 1'-0"

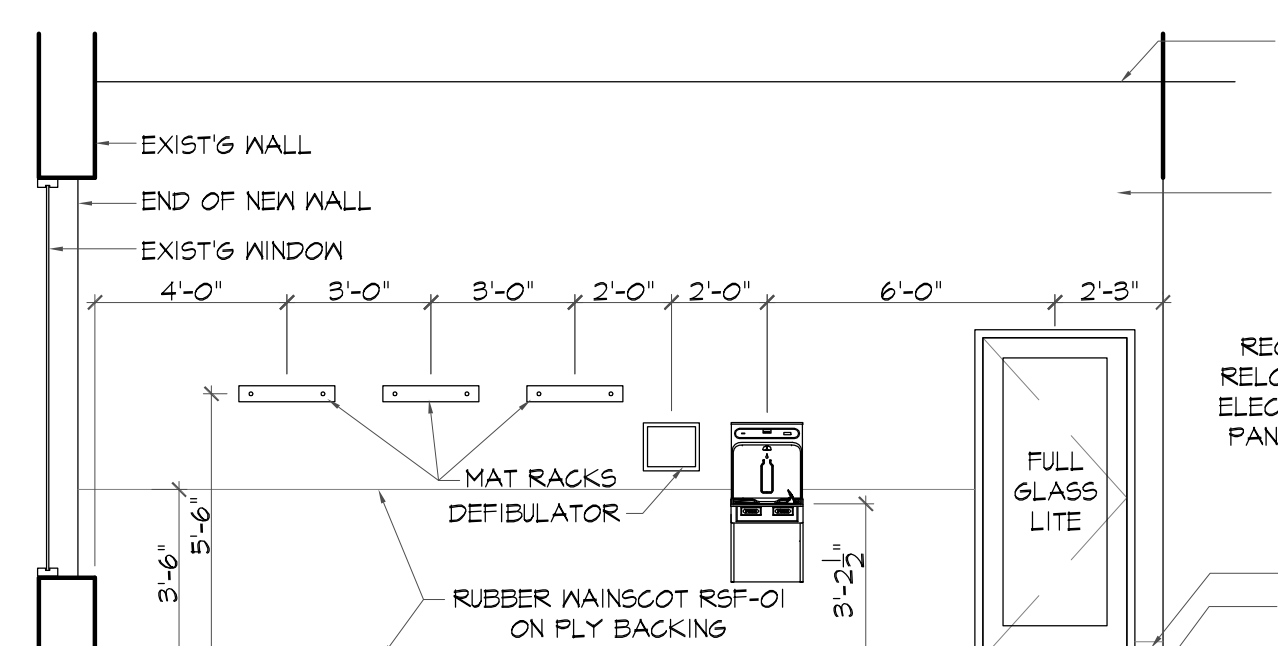

18

WALL ELEV

SCALE: 1/4" = 1'-0"

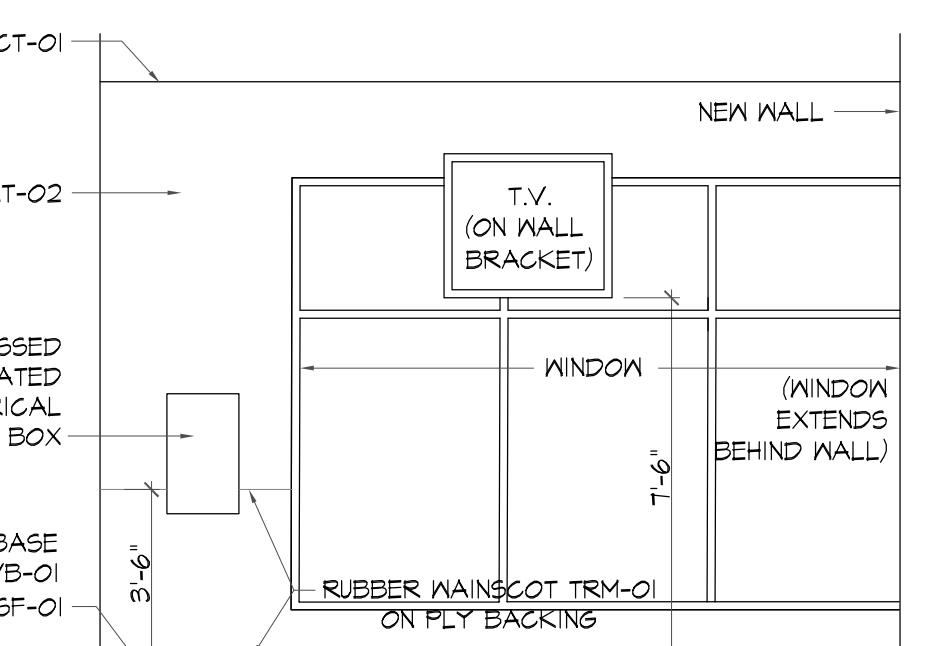

17

WALL ELEV

SCALE: 1/4" = 1'-0"

PROJECT NO. U51601

DRAWN BY B.M.R.

APPROVED BY B.M.R.

DATE 22-JULY-16

SCALE AS NOTED

TITLE INTERIOR ELEVATIONS

SHEET NUMBER A-5.0