



LED 10W & 13 Wallpacks. Patent Pending thermal management system. 100,000 hour L70 lifespan. 5 Year Warranty.

Color: Bronze

Weight: 3.3 lbs

**Project:**

**Type:**

**Prepared By:**

**Date:**

#### Driver Info

Type:	Constant Current
120V:	0.21A
208V:	0.14A
240V:	0.12A
277V:	N/A
Input Watts:	13W
Efficiency:	76%

#### LED Info

Watts:	10W
Color Temp:	3000K
Color Accuracy:	83 CRI
L70 Lifespan:	100000
Lumens:	410
Efficacy:	31 LPW

## Technical Specifications

### Listings

#### UL Listing:

Suitable for Wet Locations as a Downlight. Suitable for Damp Locations as an Uplight. Wall Mount only. Suitable for Mounting within 4ft. of ground.

#### Dark Sky Approved:

The International Dark Sky Association has approved this product as a full cutoff, fully shielded luminaire.

#### IESNA LM-79 & IESNA LM-80 Testing:

RAB LED luminaires have been tested by an independent laboratory in accordance with IESNA LM-79 and 80, and have received the Department of Energy "Lighting Facts" label.

### LED Characteristics

#### Lifespan:

100,000-hour LED lifespan based on IES LM-80 results and TM-21 calculations.

#### Color Consistency:

3-step MacAdam Ellipse binning to achieve consistent fixture-to-fixture color.

#### Color Stability:

LED color temperature is warrantied to shift no more than 200K in CCT over a 5 year period.

#### Color Uniformity:

RAB's range of CCT (Correlated color temperature) follows the guidelines of the American National Standard for Specifications for the Chromaticity of Solid State Lighting (SSL) Products, ANSI C78.377-2015.

### Construction

#### Finish:

Our environmentally friendly polyester powder coatings are formulated for high-durability and long-lasting color, and contains no VOC or toxic heavy metals.

#### Cold Weather Starting:

The minimum starting temperature is -40°C/-40°F

#### Ambient Temperature:

Suitable for use in 40°C (104°F) ambient temperatures

#### Thermal Management:

Cast aluminum Thermal Management system for optimal heat sinking. The LPACK is designed for cool operation, most efficient output and maximum LED life by minimizing LED junction temperature.

#### Housing:

Precision die cast aluminum housing, lens frame.

#### Mounting:

Junction box.

#### Green Technology:

RAB LEDs are Mercury, Arsenic and UV free.

#### For use on LEED Buildings:

IDA Dark Sky Approval means that this fixture can be used to achieve LEED Credits for Light Pollution Reduction.

#### Gaskets:

High Temperature Silicone.

### Electrical

#### Driver:

Multi-chip 10W high output long life LED Driver Constant Current, Class II, 120V-240V, 50/60/ Hz, 350mA.

### Optical

#### Lumen Maintenance:

The LED will deliver 70% of its initial lumens at 100,000 hours of operation.

### Other

#### California Title 24:

See WPLED10/PC for a 2013 California Title 24 compliant model.

#### Patents:

The design of the LPACK is protected by U.S. Pat. D604,004 and patents pending in Canada, China and Taiwan.

#### Patents:

The LPACK design is protected under patents in the U.S. Pat. D608,040, Canada Pat. 130,243, China Pat. 200930183252.2, and pending patents in Taiwan and Mexico.

#### Warranty:

RAB warrants that our LED products will be free from defects in materials and workmanship for a period of five (5) years from the date of delivery to the end user, including coverage of light output, color stability, driver performance and fixture finish.

#### Equivalency:

The WPLED10 is Equivalent in delivered lumens to a 70W Metal Halide Wallpack.

#### HID Replacement Range:

The WPLED10 can be used to replace 35-100W Metal Halide Wallpacks based on delivered lumens.

## Dimensions

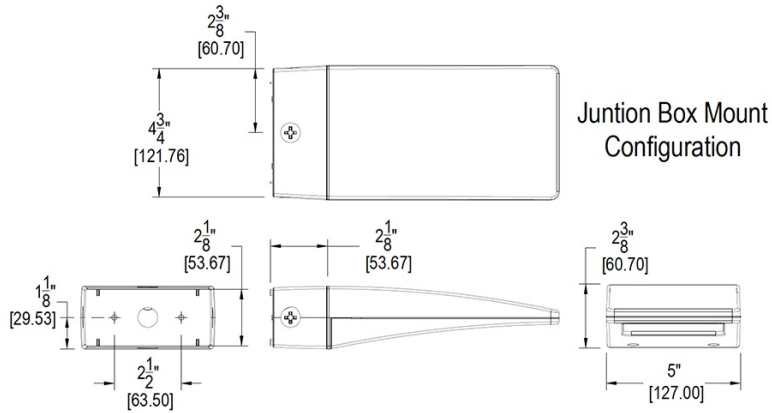

## Features

- High performance LED light engine
- Maintains 70% of initial lumens at 100,000 hours
- Weatherproof high temperature silicone gaskets
- Superior heat sinking with die cast aluminum housing and external fins
- 5-year warranty

## Ordering Matrix

Family	Watts	Color Temp	Sensor	Surface Plate	Surface Place	Finish	Photocell
WPLED	10 = 10W 13 = 13W	= 5000K (Cool) Y = 3000K (Warm) N = 4000K (Neutral)	= No Sensor MS = Mini Sensor	= No Surface Plate	S = Surface Plate	= Bronze W = White	= No Photocell /PC = 120V Button /PCS = 120V Swivel /PC2 = 277V Button



<b>LUNA 1666SK-LED</b>	
SATIN BLACK	

WIDTH:	9.0"
HEIGHT:	7.0"
WEIGHT:	3.0 LBS
MATERIAL:	EXTRUDED ALUMINUM
GLASS:	ETCHED GLASS LENS
BACKPLATE WIDTH:	9.0"
BACKPLATE HEIGHT:	7.0"
SOCKET:	1-5.50W COL-35 *INCLUDED
DARK SKY:	YES
<b>LED INFO:</b>	
LUMENS:	250
COLOR TEMP:	2700k
CRI:	90
LED WATTAGE:	6w
INCANDESCENT EQUIVALENCY:	35w
DIMMABLE:	Yes, on any Incandescent, MLV, ELV, or C-L dimmer.
NOTES:	PATENT: US AND FOREIGN PATENTS PENDING   THIS FIXTURE WILL CAST LIGHT DOWN.
EXTENSION:	4.0"
TTO:	3.5"
CERTIFICATION:	C-US WET RATED
VOLTAGE:	120V
UPC:	640665166651

AT HINKLEY, WE EMBRACE THE DESIGN PHILOSOPHY THAT YOU CAN MERGE TOGETHER THE LIGHTING, FURNITURE, ART, COLORS AND ACCESSORIES YOU LOVE INTO A BEAUTIFUL ENVIRONMENT THAT DEFINES YOUR OWN PERSONAL STYLE. WE HOPE YOU WILL BE INSPIRED BY OUR COMMITMENT TO KEEP YOUR 'LIFE AGLOW.'

*life*AGLOW®

## FEATURES & SPECIFICATIONS

**INTENDED USE** — Typical applications include corridors, lobbies, conference rooms and private offices.

**CONSTRUCTION** — Galvanized steel mounting/plaster frame; galvanized steel junction box with bottom-hinged access covers and spring latches. Reflectors are retained by torsion springs.

Vertically adjustable mounting brackets with commercial bar hangers provide 3-3/4" total adjustment.

Two combination 1/2"-3/4" and four 1/2" knockouts for straight-through conduit runs. Capacity: 8 (4 in, 4 out). No. 12 AWG conductors, rated for 90°C.

Accommodates 12"-24" joist spacing.

Passive cooling thermal management for 25°C standard; high ambient (40°C) option available. Light engine and drivers are accessible from above or below ceiling.

Max ceiling thickness 1-1/2".

**OPTICS** — LEDs are binned to a 3-step SDCM; 80 CRI minimum.

LED light source concealed with diffusing optical lens.

General illumination lighting with 1.0 S/MH and 55° cutoff to source and source image.

Self-flanged anodized reflectors in specular, semi-specular, or matte diffuse finishes. Also available in white and black painted reflectors.

**ELECTRICAL** — Multi-volt (120-277V, 50/60Hz) eldoLED 0-10V dimming drivers mounted to junction box, 10% or 1% minimum dimming level available.

0-10V dimming fixture requires two (2) additional low-voltage wires to be pulled.

70% lumen maintenance at 50,000 hours.

**LISTINGS** — Certified to US and Canadian safety standards. Damp location standard (wet location, covered ceiling optional).

**WARRANTY** — 5-year limited warranty. Complete warranty terms located at

[www.acuitybrands.com/CustomerResources/Terms\\_and\\_conditions.aspx](http://www.acuitybrands.com/CustomerResources/Terms_and_conditions.aspx)

Actual performance may differ as a result of end-user environment and application.

All values are design or typical values, measured under laboratory conditions at 25 °C.

Note: Specifications subject to change without notice.

Catalog Number
Notes
Type

# LDN6

**6" OPEN and WALLWASH LED  
Non-IC  
New Construction Downlight**



### ORDERING INFORMATION

Lead times will vary depending on options selected. Consult with your sales representative.

**Example:** LDN6 35/15 L06AR LSS MVOLT EZ10

LDN6		Color temperature				Lumens <sup>1</sup>				Aperture/Trim Color			Finish		Voltage	
Series		27/	2700K	05	500 lumens	25	2500 lumens	L06	Downlight	AR	Clear	LSS	Semi-specular	MVOLT	Multi-volt	
		30/	3000K	10	1000 lumens	30	3000 lumens	LW6	Wallwash	WR <sup>2</sup>	White	LD	Matte diffuse	120	120V	
		35/	3500K	15	1500 lumens	40	4000 lumens			BR <sup>2</sup>	Black	LS	Specular	277	277V	
		40/	4000K	20	2000 lumens	50	5000 lumens							347 <sup>3</sup>	347V	

Driver	Options
EZ10 eldoLED 10% 0-10V	SF <sup>4</sup> Single fuse
EZ1 eldoLED 1% 0-10V	TRW <sup>5</sup> White painted flange
	TRBL <sup>5</sup> Black painted flange
	ELR <sup>4</sup> Batterypack (remote)
	EL <sup>4</sup> Batterypack
	NPS80EZ <sup>4</sup> nLight® dimming pack controls 0-10V eldoLED drivers.
	NPS80EZER <sup>4</sup> nLight® dimming pack controls 0-10V eldoLED drivers. ER controls fixtures on emergency circuit.
	HAO High ambient option
	CP Chicago Plenum
	WL Wet location
	RRL <sup>___</sup> RELOC®-ready luminaire connectors enable a simple and consistent factory installed option across all ABL luminaire brands. Refer to RRL for complete nomenclature. Available only in RRLA, RRLB, RRLAE, and RRLC12S.

Accessories: Order as separate catalog number.	
<a href="#">EAC ISSM 375</a>	Compact interruptible emergency AC power system
<a href="#">EAC ISSM 125</a>	Compact interruptible emergency AC power system
GRA68 JZ	Oversized trim ring with 8" outside diameter <sup>1</sup>
SCA6	Sloped ceiling adapter. Refer to <a href="#">TECH-SCA</a> for more options.

#### Notes

- Overall height varies based on lumen package; refer to dimensional chart on page 3.
- Not available with finishes.
- Not available with emergency options.
- Must specify voltage 120V or 277V.
- Available with clear (AR) reflector only.

# LDN6

---

## PHOTOMETRY

Consult Factory for Photometry.

# LDN6

\* All dimensions are inches (centimeters) unless otherwise noted.

## LDN6 1500 LUMEN

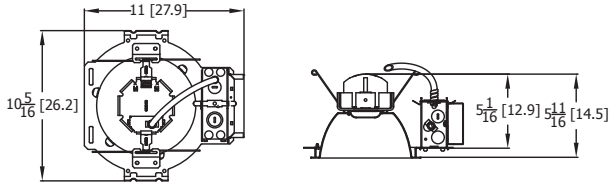

Aperture: 6-1/4 (15.9)  
Ceiling Opening: 7-1/8 (18.1)  
Overlap trim: 7-1/2 (19.1)

## LDN6 3000 LUMEN

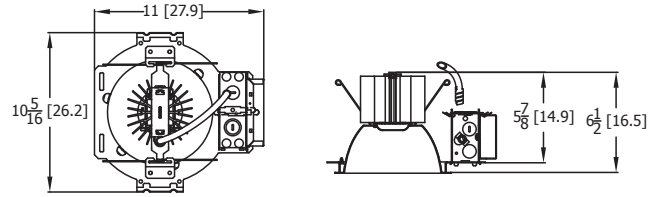

Aperture: 6-1/4 (15.9)  
Ceiling Opening: 7-1/8 (18.1)  
Overlap trim: 7-1/2 (19.1)

## LDN6 5000 LUMEN

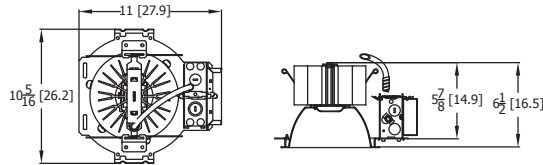

Marked Spacing: 24 x 24 x 10  
Aperture: 6-1/4 (15.9)  
Ceiling Opening: 7-1/8 (18.1)  
Overlap trim: 7-1/2 (19.1)

## LDN6 CP

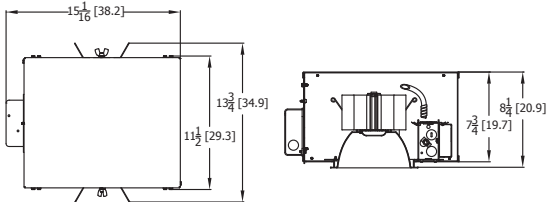

Marked Spacing above 3000 lumen: 24 x 24 x 10  
Aperture: 6-1/4 (15.9)  
Ceiling Opening: 7-1/8 (18.1)  
Overlap trim: 7-1/2 (19.1)

## LDN6 1500 EL-ELR

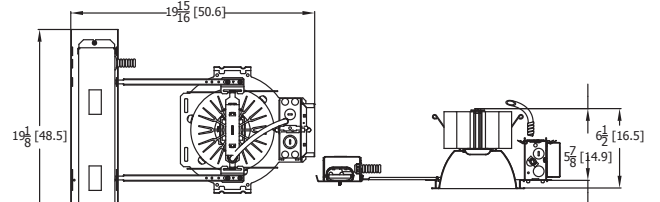

Marked Spacing above 3000 lumen: 24 x 24 x 10  
Aperture: 6-1/4 (15.9)  
Ceiling Opening: 7-1/8 (18.1)  
Overlap trim: 7-1/2 (19.1)

### Notes

- Tested in accordance with IESNA LM-79-08.
- Tested to current IES and NEMA standards under stabilized laboratory conditions.
- CRI: 80 typical.

ADDITIONAL DATA

COMPATIBLE 0-10V WALL-MOUNT DIMMERS		
MANUFACTURER	PART NO.	POWER BOOSTER AVAILABLE
Lutron®	Diva® DDTV	
	Diva® DVSCTV	
	Nova T® NTFTV	
	Nova® NFTV	
Leviton®	AWSMT-7DW	CN100
	AWSMG-7DW	PE300
	AMRMG-7DW	
	Leviton Centura Fluorescent Control System	
	IllumaTech® IP7 Series	
Synergy®	ISD BC	RDMFC
	SLD LPCS	
	Digital Equinox (DEQ BC)	
Douglas Lighting Controls	WPC-5721	
Entertainment Technology	Tap Glide TG600FAM120 (120V)	
	Tap Glide Heatsink TGH1500FAM120 (120V)	
	Oasis 0A2000FAMU	
Honeywell	EL7315A1019	EL7305A1010 (optional)
	EL7315A1009	
HUNT Dimming	Preset slide: PS-010-IV and PS-010-WH	
	Preset slide: PS-010-3W-IV and PS-010-3W-WH	
	Preset slide, controls FD-010: PS-IFC-010-IV and PS-IFC-010-WH-120/277V	
	Preset slide, controls FD-010: PS-IFC-010-3W-IV and PS-IFC-010-3W-WH-120/277V	
	Remote mounted unit: FD-010	
Lehigh Electronic Products	Solitaire	PBX
PDM Electrical Products	WPC-5721	
Starfield Controls	TR61 with DALI interface port	RT03 DALInet Router
WattStopper®	LS-4 used with LCD-101 and LCD-103	

EL/ELR AVAILABILITY/COMPATIBILITY - INITIAL LUMENS			
Lumen package	Watts	Initial lumens EL/ELR	Emergency LED driver
600	12	500	PS1050
1000	18	575	PS1050
1500	26	640	PS1050
2000	35	690	PS1050

LUMEN OUTPUT MULTIPLIERS - FINISH			
	Clear (AR)	White (WR)	Black (BR)
Specular (LS)	1.0	N/A	N/A
Semi-specular (LSS)	0.950	N/A	N/A
Matte diffuse (LD)	0.85	N/A	N/A
Painted	N/A	0.87	0.73

LUMEN OUTPUT MULTIPLIERS - CCT				
	2700K	3000K	3500K	4000K
80CRI	0.950	0.966	1.000	1.025

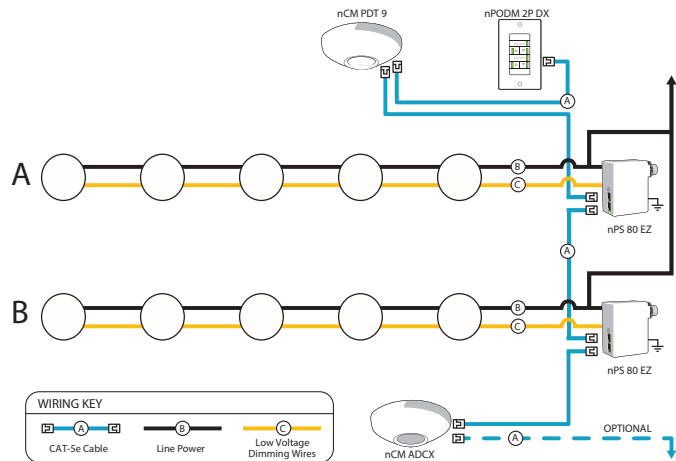

nLight® Control Accessories:			
Order as separate catalog number. Visit <a href="http://www.sensorswitch.com/nLight">www.sensorswitch.com/nLight</a> for complete listing of nLight controls.			
<b>WallPod stations</b>	<b>Model number</b>	<b>Occupancy sensors</b>	<b>Model number</b>
On/Off	nPODM [color]	Small motion 360°, ceiling (PIR / dual tech)	nCM 9 / nCM PDT 9
On/Off & Raise/Lower	nPODM DX [color]	Large motion 360°, ceiling (PIR / dual tech)	nCM 10 / nCM PDT 10
Graphic Touchscreen	nPOD GFX [color]	Wide view (PIR / dual tech)	nWV 16 / nWV PDT 16
<b>Photocell controls</b>	<b>Model number</b>	Wall Switch w/ Raise/Lower (PIR / dual tech)	nWSX LV DX / nWSX PDT LV DX
Dimming	nCM ADCX	<b>Cat-5 cables (plenum rated)</b>	<b>Model number</b>
		10', CAT5 10FT	CAT5 10FT J1
		15', CAT5 15FT	CAT5 15FT J1

Call Toll Free 800-344-2242



ORNAMENTAL FENCES  
OF DISTINCTION™

# ALUMINUM FENCE STYLE GUIDE

## ALUMINUM FENCE

### Exposed Picket Designs

These designs have no top rail, and are classic "wrought iron" designs that have been used for over 100 years.

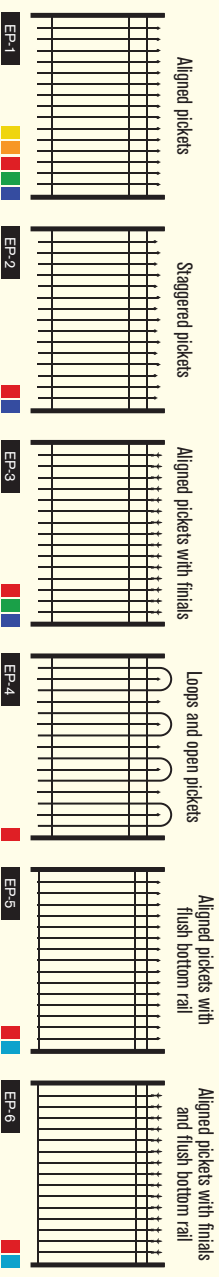

### Covered Picket Designs

A smooth top rail makes these styles perfect around pools. These are our most popular designs because of this. Their aluminum construction makes them ideal for pool enclosures since they can never rust.

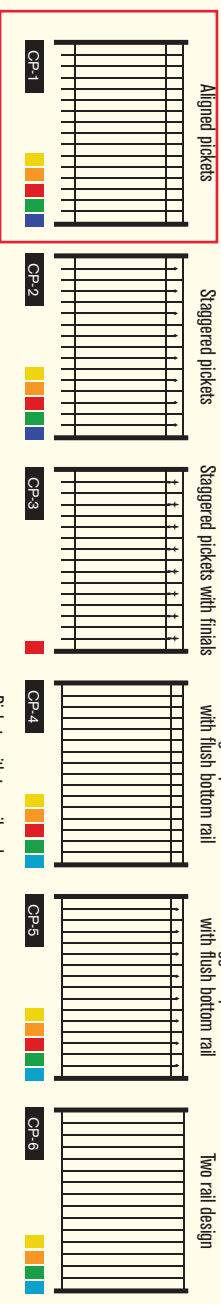

### Specialty Designs

These fences have a narrower space between the pickets to keep pets inside your yard. The spacing also makes it very difficult for children to obtain a foothold on the fence.

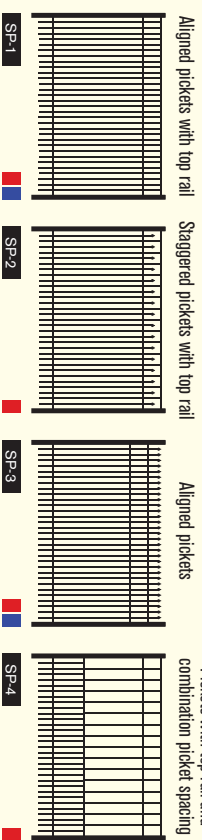

## WIRE FENCE

### Wire Fence Designs

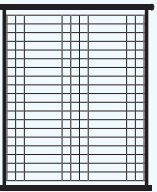

Jerith's Patriot line of wire fence is a great alternative to aluminum fence that's strong, but has a more subtle visual presence that blends in with the environment.

To see our full line of wire fence alternatives, download the Patriot Wire Fence Style Guide

## ACCESSORIES



### FINIALS, GATES, ARBORS AND LATCHES

Jerith has a wide variety of scrolls, finials and other items to accent your Jerith fence. Gates are also available to match any of our fence designs, and we have aluminum arbors to highlight a walkway or gate into your yard.

### AVAILABLE GRADES

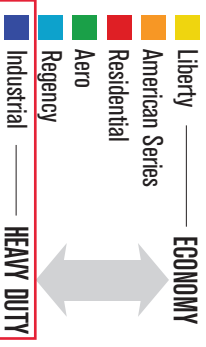

Technical specifications are available on our website with available heights and accessories.

Jerith Manufacturing Company, Inc.

14400 McNulty Road, Philadelphia, PA 19154

215-676-4068 • Fax 215-676-9756

Match the styles seen here with actual product installations on our website at [www.jerith.com](http://www.jerith.com)



## COMPLETE ENCLOSURES



Trek Bicycle Shop | Columbus, OH

**Covrit**® provides a complete line of screening solutions to hide, protect or partition anything on your property, while enhancing the aesthetics of your environment.

### **Ingenious (in•gen•ious):**

1. Characterized by cleverness or originality of construction
2. Inventive or resourceful

Distinctive, expertly fabricated screen walls, gates and doors tailored specifically to your requirements, budget and site.

Available in 14 standard wall designs and 11 standard gate styles. Custom colors and styles are always available.

Maintenance free components provide years of trouble-free service.



Enhance your corporate/office or retail image while offering protection and screening for your waste or recycling areas, outdoor storage space or any other location. You define it and CityScapes' engineering design consultants will create a solution.

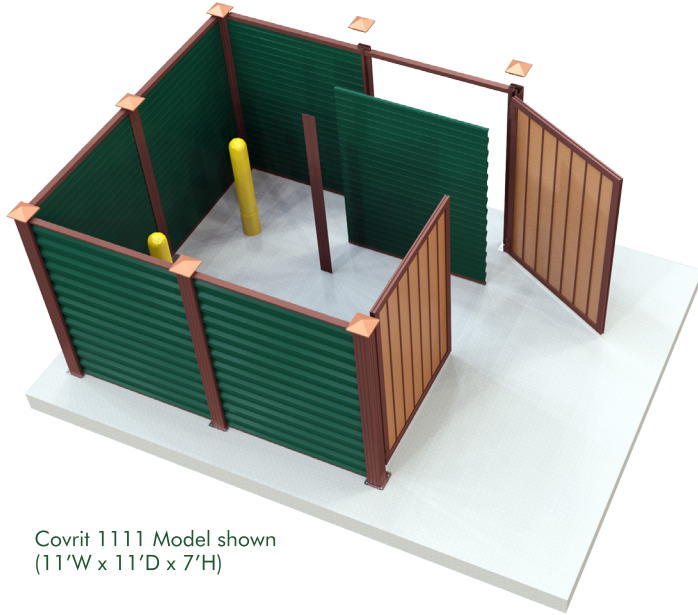

Covrit 1111 Model shown  
(11'W x 11'D x 7'H)

**Smart:** Maintenance free designs and styles that look new for many years, at a savings of up to 50% off the cost of traditional brick and mortar.

**Stylish:** We offer numerous designs, sizes and colors to complement any environment.

**Versatile:** Modular, flexible design provides for fast, easy set up of your screening project.

Our high standards coupled with years of advanced engineering and quality assurance testing have resulted in the industry's top performing screening product. Our professional grade screen wall systems and gates have transformed property at big box retailers, shopping centers, restaurants, country clubs, community parks, apartment complexes, gas stations, bars, and banks.

RETAIL  
SHOPPING  
CENTER

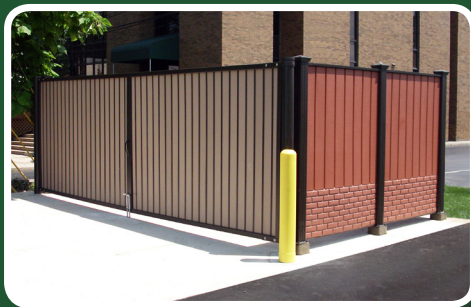

Trek Bicycle Shop | Columbus, OH

HIGH  
SCHOOL

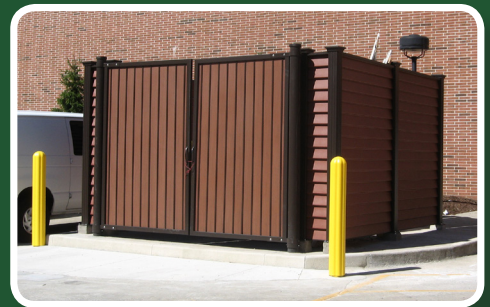

Carmel High School | Carmel, IN

CORPORATE  
BUSINESS



Mega Industries | Kansas City, MO

MEDICAL  
CENTER



Koch Healthcare | Granite City, IL

We offer a wide range of designs and materials in our screen walls, gates and trim options.

**SCREEN WALL MATERIALS AND STYLES**



Horizontal Vertical

**PLANKWALL™ PVC**



Clapboard Clapboard with Brick Board & Batten Board & Batten with Brick Louver

**ACRYLICAP™ ABS**



Brazilian Hardwood

**IPE**



Classic Brick

**POLYURETHANE**



Painted Steel



Stucco on Steel



Structural Rib



Shallow Rib



Venetian

**METAL SERIES**

**GATE STYLES**

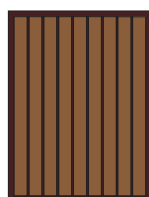

Madison



Mission



Redondo

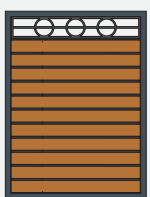

Sequoia

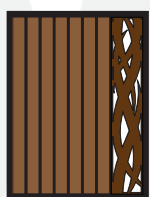

Muir Woods

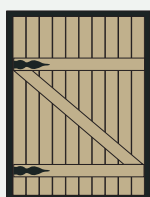

Augusta

VIEW OUR TOUGHGATE™ BROCHURE FOR MORE INFORMATION ON OUR GATE STYLES AND MATERIALS.



Canby



Flagstaff



Avon

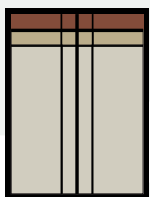

Richland



Potomac

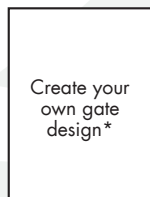

Create your own gate design\*

Custom

\*We can create custom designs by routing out a shape or pattern to match your specifications.

**TRIM STYLES | TOP RAILS & CAPS**

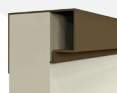

Box Top

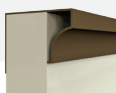

Cove Top

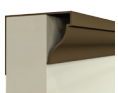

Roman Ogee

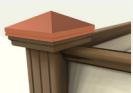

Standard Hip



Shallow Hip



Mortarboard

## Our Most Popular Configurations:

With enclosure sizes ranging from 11' deep x 11' wide to 13' deep x 26' wide, our base models can accommodate many project uses.

The innovative modular construction and revolutionary product design of Covrit also enables custom shape and size enclosures to suit unique project needs.

1100 SERIES  
1300 SERIES

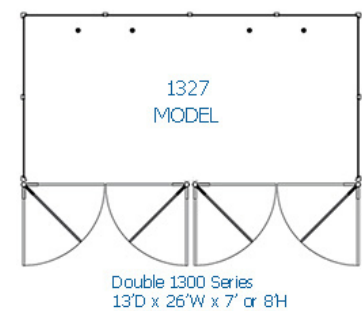
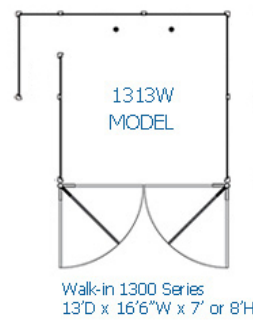
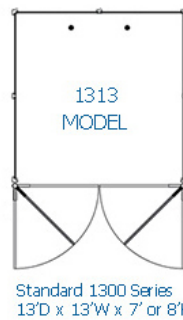
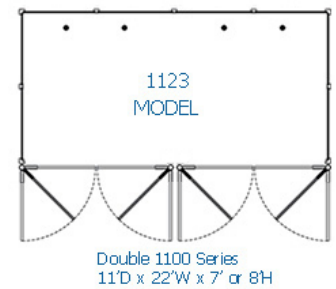
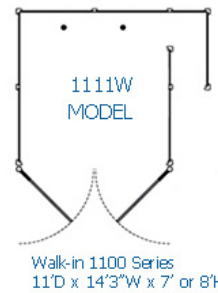
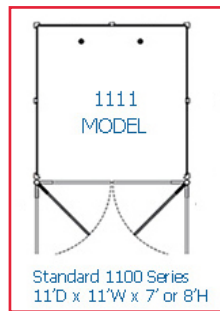

DISCOVER WHY MORE ARCHITECTS, DEVELOPERS,  
GENERAL CONTRACTORS, BUILDING OWNERS AND  
BUSINESS OWNERS ARE SWITCHING TO  
CITYSCAPES SCREENING SOLUTIONS.

Expert Solutions, Easy Ordering and White Glove Service.



Phone: (877) 727-3367  
Web: [www.cityscapesinc.com](http://www.cityscapesinc.com)  
Email: [contact@cityscapesinc.com](mailto:contact@cityscapesinc.com)

CityScapes Inc.  
4200 Lyman Court  
Hilliard, OH 43026

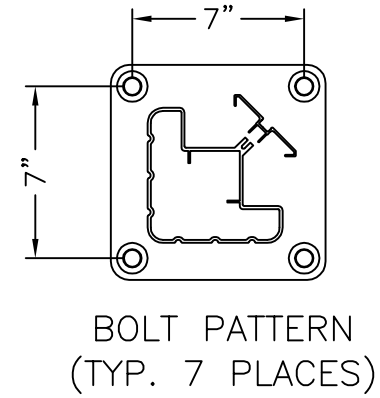
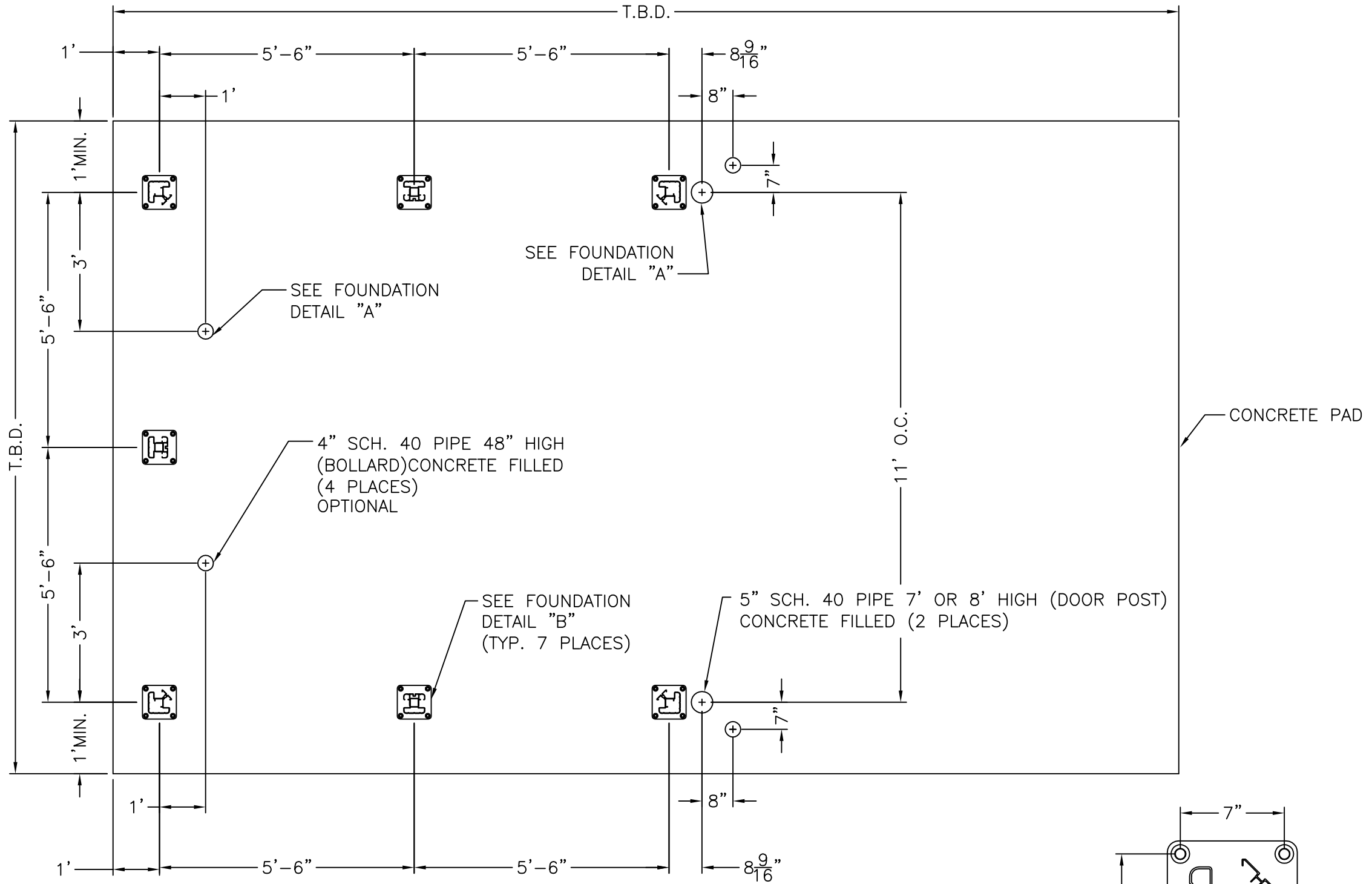
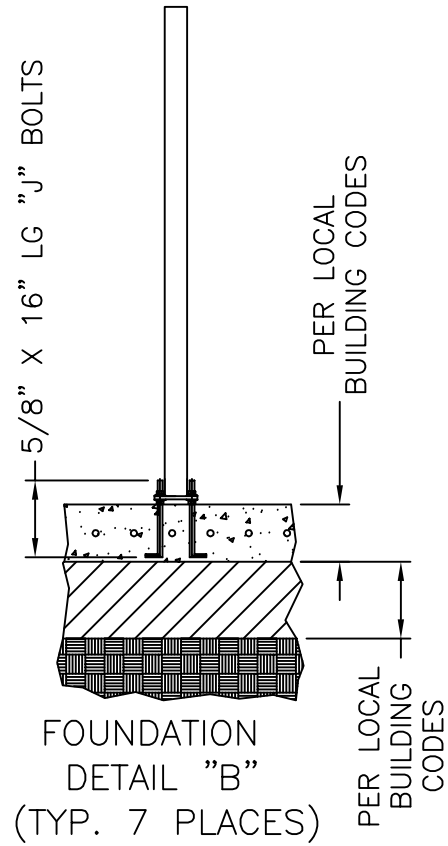
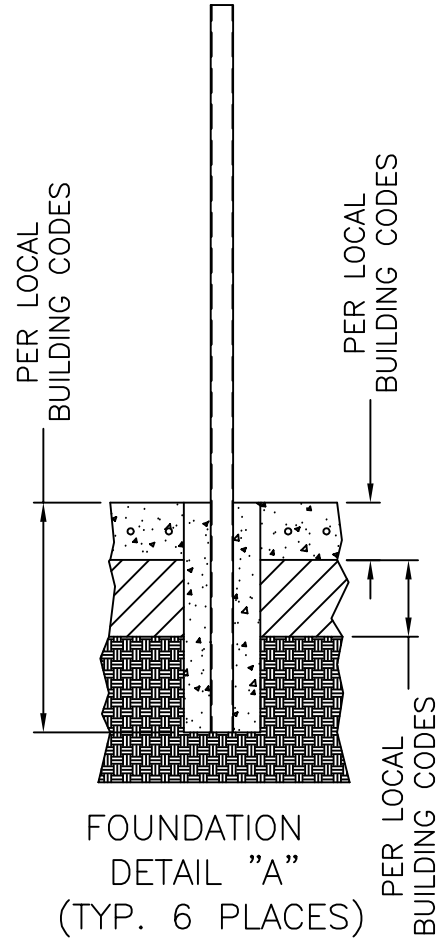

PROJECT DESCRIPTION COVRT. SCREEN	REVISION REF.# AND DATE	SCALE	NTS
	A 4/22/10	SHEET 1	OF 1
PAGE DESCRIPTION STANDARD 11' X 11" MODULAR LAYOUT PLAN	B 11/26/14	DRAWN BY	CHECKED BY
CLIENT	CONTACT PERSON	PAS	
ADDRESS	CITY	STATE	ZIP
JOB SITE LOCATION	ADDRESS	CITY	STATE
		DATE FILE CREATED	DWG FILE #
		4/22/10	106199
		PART #	

**cityscapes**  
architectural innovations  
4200 LYMAN COURT  
HILLIARD, OH (614) 850-2549

THIS IS AN ORIGINAL UNPUBLISHED DRAWING SUBMITTED FOR YOUR PERSONAL USE ONLY. NO REPRODUCTION, REUSE, OR DISTRIBUTION OF THIS DRAWING OR ANY INFORMATION CONTAINED HEREIN IS PERMITTED WITHOUT THE WRITTEN PERMISSION OF CITYSCAPES INTERNATIONAL, INCORPORATED. IT IS NOT TO BE REPRODUCED, EXHIBITED, OR FABRICATED IN ANY FASHION WITHOUT PERMISSION FROM AN AUTHORIZED OFFICER OF THE COMPANY.