

FIG. 604.3.1
SIZE OF CLEARANCE FOR WATER CLOSET

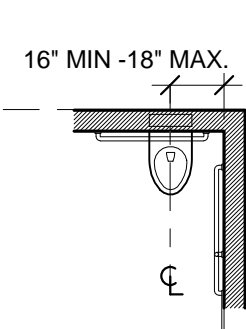

FIG. 604.2
WATER CLOSET LOCATION

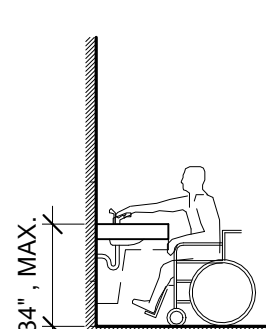

FIG. 606.3 -
HEIGHT OF LAVATORIES
AND SINKS

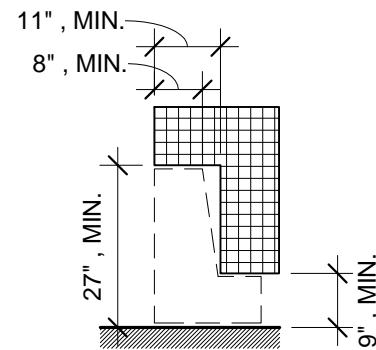

FIG. 306.3 -
KNEE CLEARANCE

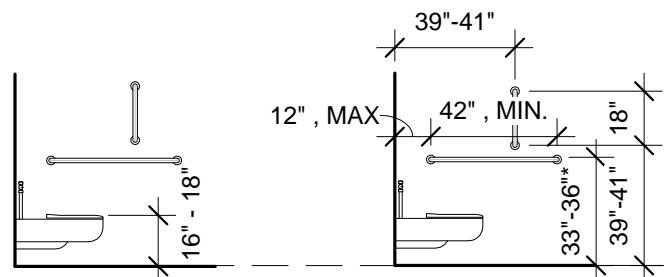

FIG. 604.4
HEIGHT TO TOP OF SEAT

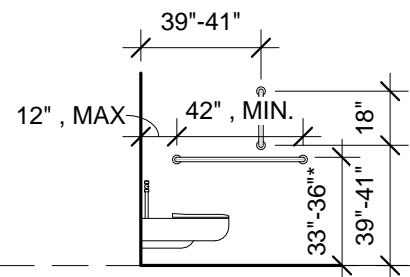

FIG. 604.5.1
SIDE WALL GRAB BAR
FOR WATER CLOSET
* TO TOP OF GRAB BAR

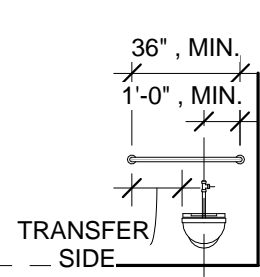

FIG. 604.5.2
REAR WALL GRAB BAR
FOR WATER CLOSET

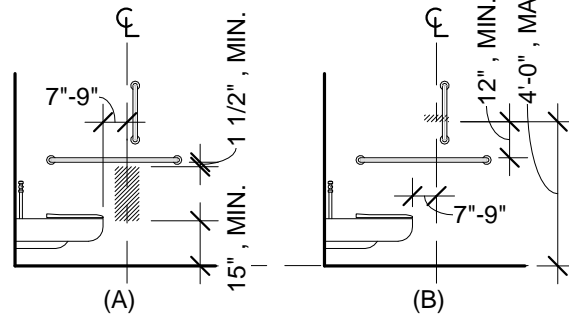
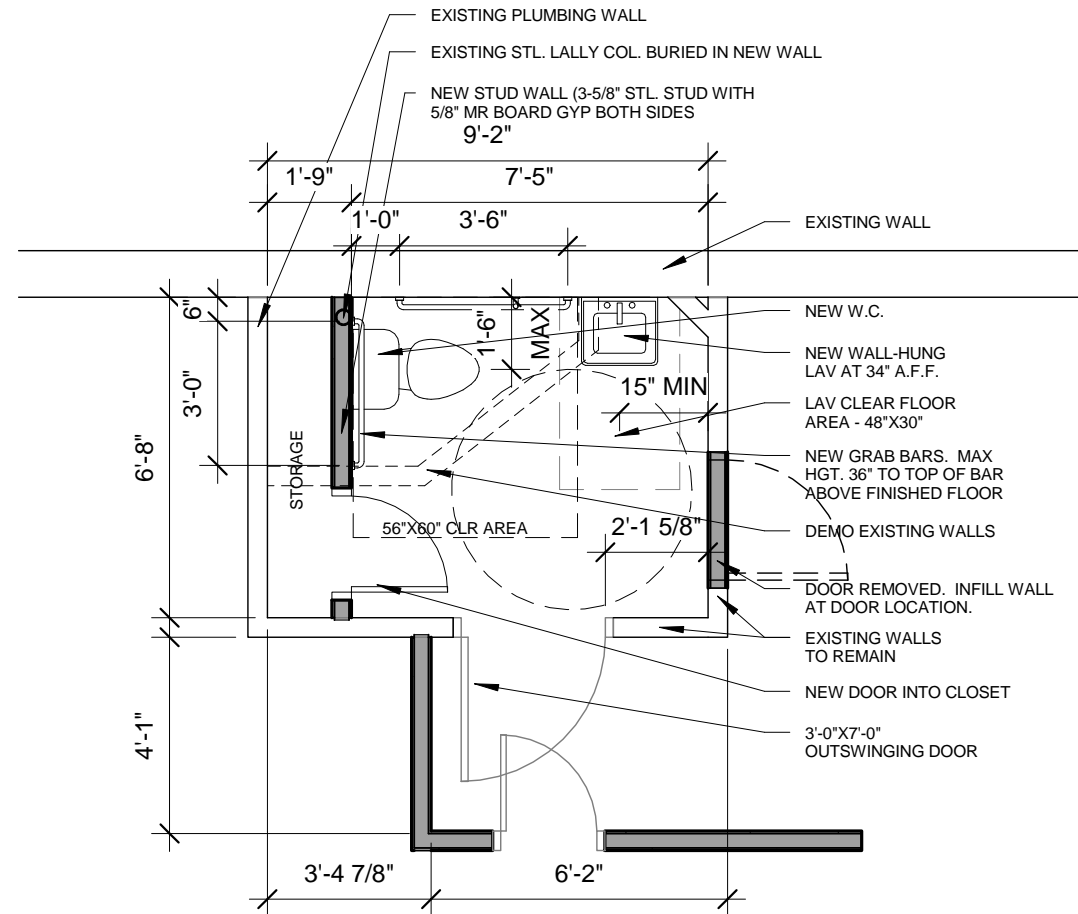

FIG. 604.7
DISPENSER LOCATION
(A) BELOW GRAB BAR
(B) ABOVE GRAB BAR



1 | BATHROOM PLAN

1/4" = 1'-0"

* 54 WHERE BOTH A CLOSER AND LATCH ARE PROVIDED

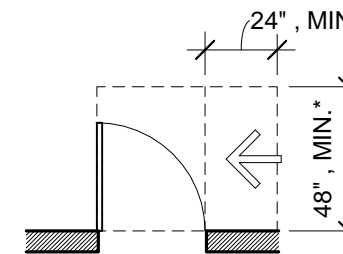

(F) LATCH APPROACH,
PULL SIDE

Architect:
ARCHETYPE
architects
48 Union Wharf Portland, Maine 04101
(207) 772-6022 Fax (207) 772-4056

Date: 05/29/15
Scale: As indicated
BATHROOM PLAN

Project: BLUE ROOSTER
5 Dana Street
Portland, ME

SK01