

City of Portland, Maine – Building or Use Permit Application 389 Congress Street, 04101, Tel: (207) 874-8703, FAX: 874-8716

Location of Construction: 33 Wharf Street (AKA Fore St.) 04101		Owner: Soletsky Limited Liability		Phone: 775-0887		Permit No: 990674	
Owner Address: Lynne Leavitt Street & Company 33 Wharf St. 04101		Lessee/Buyer's Name: Dana B. Street		Phone:		Business Name: Street & Company	
Contractor Name: Maine Bay Canvas		Address: 55 Industrial Way, Ptld, ME 04103		Phone: 878-8888		Permit Issued: JUN 24 1999 CITY OF PORTLAND	
Past Use: Restaurant		Proposed Use: Same		COST OF WORK: \$ 1400.00		PERMIT FEE: \$ 25.00	
				FIRE DEPT. <input type="checkbox"/> Approved <input type="checkbox"/> Denied		INSPECTION: <input checked="" type="checkbox"/> (A) Use Group: B-3 Type: 3B 060990	
Proposed Project Description: 20' x 6' Awning on Wharf St. (Retractable) Awning only - no graphics (approx 10' x 6')				Signature:		Signature: <i>[Signature]</i>	
Permit Taken By: SP		Date Applied For: June 4, 1999		PEDESTRIAN ACTIVITIES DISTRICT (P.A.D.) Action: <input type="checkbox"/> Approved <input type="checkbox"/> Approved with Conditions <input type="checkbox"/> Denied		Zoning Approval: <input type="checkbox"/> Special Zone or Reviews: <input type="checkbox"/> Shoreland <input type="checkbox"/> Wetland <input type="checkbox"/> Flood Zone <input type="checkbox"/> Subdivision <input type="checkbox"/> Site Plan maj <input type="checkbox"/> minor <input type="checkbox"/> mm <input type="checkbox"/>	
				Signature:		Date:	

1. This permit application does not preclude the Applicant(s) from meeting applicable State and Federal rules.
2. Building permits do not include plumbing, septic or electrical work.
3. Building permits are void if work is not started within six (6) months of the date of issuance. False information may invalidate a building permit and stop all work..

PERMIT ISSUED WITH REQUIREMENTS

CERTIFICATION

I hereby certify that I am the owner of record of the named property, or that the proposed work is authorized by the owner of record and that I have been authorized by the owner to make this application as his authorized agent and I agree to conform to all applicable laws of this jurisdiction. In addition, if a permit for work described in the application is issued, I certify that the code official's authorized representative shall have the authority to enter all areas covered by such permit at any reasonable hour to enforce the provisions of the code(s) applicable to such permit

June 7, 1999

SIGNATURE OF APPLICANT	ADDRESS:	DATE:	PHONE:
RESPONSIBLE PERSON IN CHARGE OF WORK, TITLE			PHONE:

CEO DISTRICT **1**

ADDRESS: 33 WHARF ST.
PERMIT APPLICATION FOR: STREET CO.
BUILDING OWNER: _____
PERMIT APPLICANT: _____
REVIEWER: John Anderson JS
DATE OF DECISION: 6/24/99

HISTORIC PRESERVATION REVIEW

Note: Your property is an individually designated landmark structure or is located within a designated historic district. As such, alterations to the building exterior or site which are visible from a public way are subject to review and approval under Article IX (Historic Preservation) of the Land Use Code. Your building or sign permit application has been reviewed to determine whether the nature or scope of the project requires review, and if so, whether it meets the standards of the historic preservation ordinance.

ACTION

Does not Require Review (e.g. Interior work only / alteration is not readily visible from a public way)

Note: this finding is based on the understanding that the application entails interior work only or that the proposed exterior alteration(s) will not be readily visible from a public way. If your project entails exterior or site alterations (including the installation of sign(s), awnings, or exterior lighting for such) these alterations must be reviewed and approved prior to commencing with the work. Contact 874-8726 for more information.

Denied Reason for Denial: _____

Approved as submitted

Approved with conditions (see below)

Conditions of Approval:

Contact Historic Preservation Staff (874-8726 or 874-8728) prior to installation of sign(s) to confirm approved location.

Your sign permit includes no reference to exterior lighting; if lighting is included, please submit information on fixtures and specifications on installation.

Other conditions:

1. Awnings to be aligned vertically
2. Front flaps on awnings to be as depicted in submitted sketches - scalloped, not fixed
3. _____

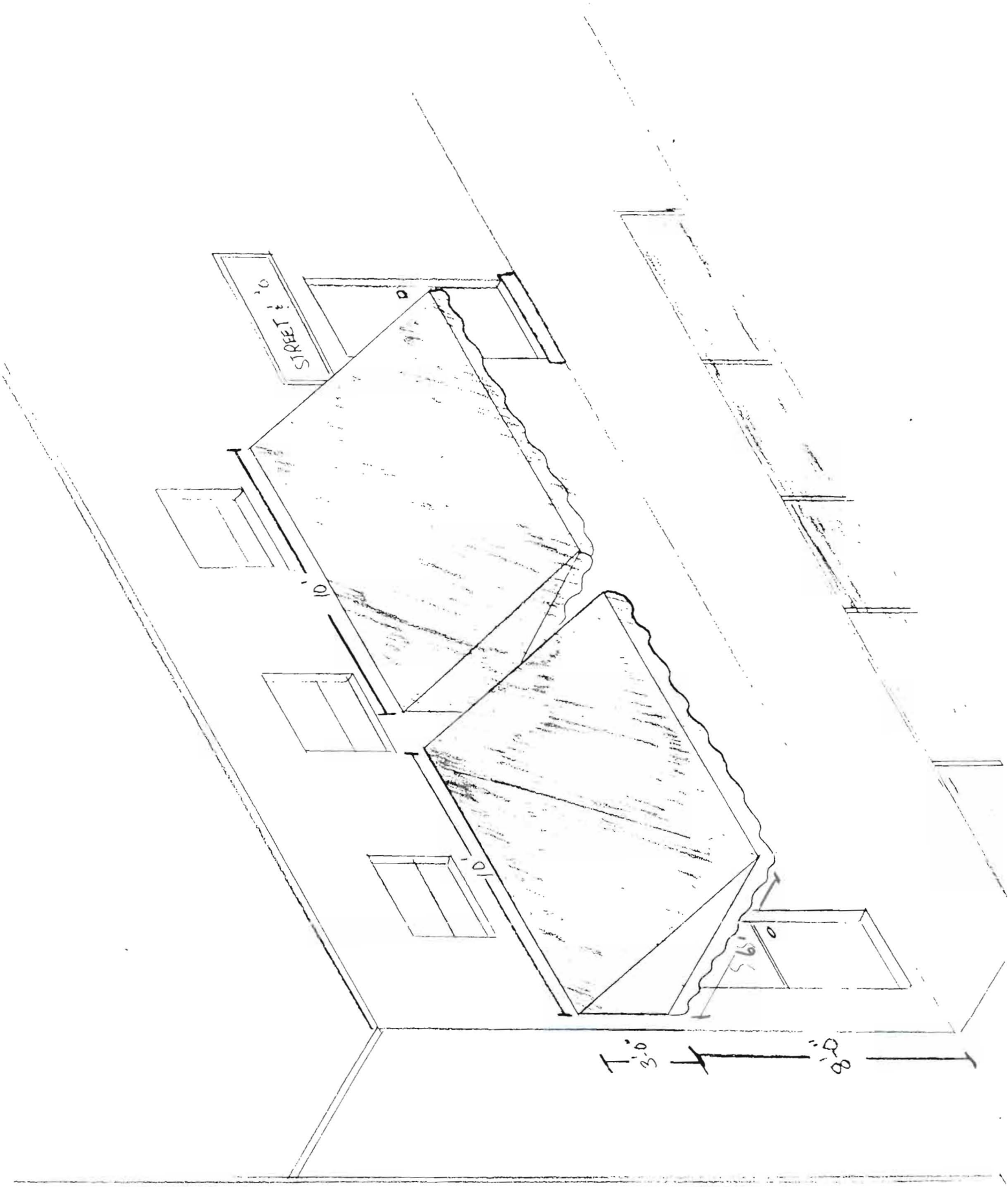

STREET

3'-0"

8'-0"

THIS IS NOT A PERMIT/CONSTRUCTION CANNOT COMMENCE UNTIL THE PERMIT IS ISSUED

**Building or Use Permit Pre-Application
Attached Single Family Dwellings/Two-Family Dwelling
Multi-Family or Commercial Structures and Additions Thereto**

In the interest of processing your application in the quickest possible manner, please complete the Information below for a Building or Use Permit.

NOTEIf you or the property owner owes real estate or personal property taxes or user charges on ANY PROPERTY within the City, payment arrangements must be made before permits of any kind are accepted.**

Location/Address of Construction (include Portion of Building) <i>*LYNNE LEAVITT</i> <i>#33 Wharf St (AKA Fore St)</i>			
Total Square Footage of Proposed Structure		Square Footage of Lot	
Tax Assessor's Chart, Block & Lot Number Chart# <i>032</i> Block# <i>N</i> Lot# <i>012</i>		Owner: <i>Solo Limited Liability</i> <i>STARR + Co</i> <i>Saletsky</i>	Telephone#: <i>207-775-0887</i>
Owner's Address: <i>Street & Company</i> <i>#33 Wharf St 04101</i>		Lessee/Buyer's Name (If Applicable) <i>Dana B Street</i>	Cost Of Work: \$ <i>1400.00</i> Fee \$ <i>25.00</i>
Proposed Project Description: (Please be as specific as possible) <i>20' x 6' Awning on wharf St. Retractable.</i>			
Contractor's Name, Address & Telephone <i>MAINE DAY CONTRACTORS</i> <i>53 Industrial Way</i> <i>Portland, ME 04103</i> <i>207 878 8888</i>			Rec'd By <i>[Signature]</i>
Current Use: <i>Rest</i>		Proposed Use: <i>Rest</i>	

Separate permits are required for Internal & External Plumbing, HVAC and Electrical installation.

- All construction must be conducted in compliance with the 1996 B.O.C.A. Building Code as amended by Section 6-Art II.
- All plumbing must be conducted in compliance with the State of Maine Plumbing Code.
- All Electrical Installation must comply with the 1996 National Electrical Code as amended by Section 6-Art III.
- HVAC (Heating, Ventilation and Air Conditioning) installation must comply with the 1993 BOCA Mechanical Code.

You must include the following with your application:

- 1) A Copy of Your Deed or Purchase and Sale Agreement
- 2) A Copy of your Construction Contract, if available
- 3) A Plot Plan/Site Plan

Minor or Major site plan review will be required for the above proposed projects. The attached checklist outlines the minimum standards for a site plan.

4) Building Plans

Unless exempted by State Law, construction documents must be designed by a registered design professional.

A complete set of construction drawings showing all of the following elements of construction:

- Cross Sections w/Framing details (including porches, decks w/ railings, and accessory structures)
- Floor Plans & Elevations
- Window and door schedules
- Foundation plans with required drainage and dampproofing
- Electrical and plumbing layout. Mechanical drawings for any specialized equipment such as furnaces, chimneys, gas equipment, HVAC equipment (air handling) or other types of work that may require special review must be included.

Certification

I hereby certify that I am the Owner of record of the named property, or that the proposed work is authorized by the owner of record and that I have been authorized by the owner to make this application as his/her authorized agent. I agree to conform to all applicable laws of this jurisdiction. In addition, if a permit for work described in this application is issued, I certify that the Code Official's authorized representative shall have the authority to enter all areas covered by this permit at any reasonable hour to enforce the provisions of the codes applicable to this permit.

Signature of applicant: <i>Dana B Street</i>	Date: <i>5-25-99</i>
--	----------------------

Building Permit Fee: \$25.00 for the 1st \$1000. cost plus \$5.00 per \$1,000.00 construction cost thereafter.
Additional Site review and related fees are attached on a separate addendum



Certificate of Flame Resistance



REGISTERED
APPLICATION
CONCERN No.

GA-217

ISSUED BY
JOHN BOYLE & COMPANY, INC.
Salisbury Road
Statesville, NC 28677
704-872-8151

Date treated or
manufactured

This is to certify that the materials described below have been flame-retardant treated (or are inherently nonflammable)

FOR Maine Bay Canvas ADDRESS 53 Industrial Way
CITY Portland STATE Maine 04103

Certification is hereby made that: (Check "a" or "b")



(a) The articles described below this Certificate have been treated with a flame-retardant chemical approved and registered by the State Fire Marshal and that the application of said chemical was done in conformance with the laws of the State of California and the Rules and Regulations of the State Fire Marshal.

Name of chemical used _____ Chem. Reg. No. _____

Method of application _____



(b) The articles described below are made from a flame-resistant fabric or material registered and approved by the State Fire Marshal for such use.

Trade name of flame-resistant fabric or material used _____ Reg. No. _____

The Flame-Retardant Process Used WILL NOT Be Removed By Washing

JOHN BOYLE & COMPANY, INC.

Name of Applicant or Production Superintendent

JOHN BOYLE & COMPANY, INC.

By

Walter Conize
Specialty Products Manager

3, 4, 5 Jaw End with Lag
(For Wood) (pgs. 120-125)

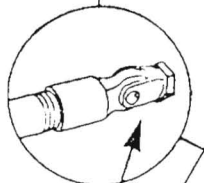
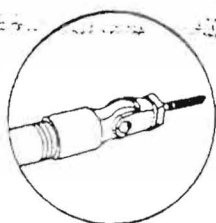

33-S & 34-S
Jaw End
(For Brick)
(pg. 120)

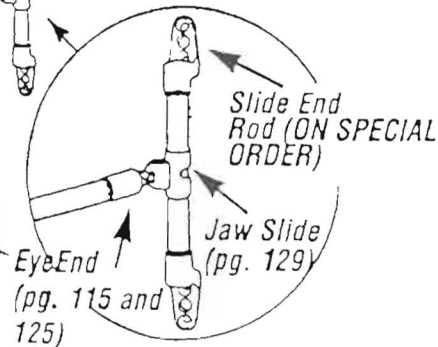
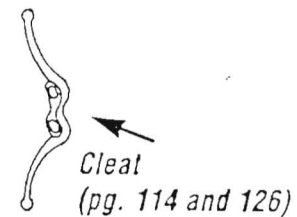
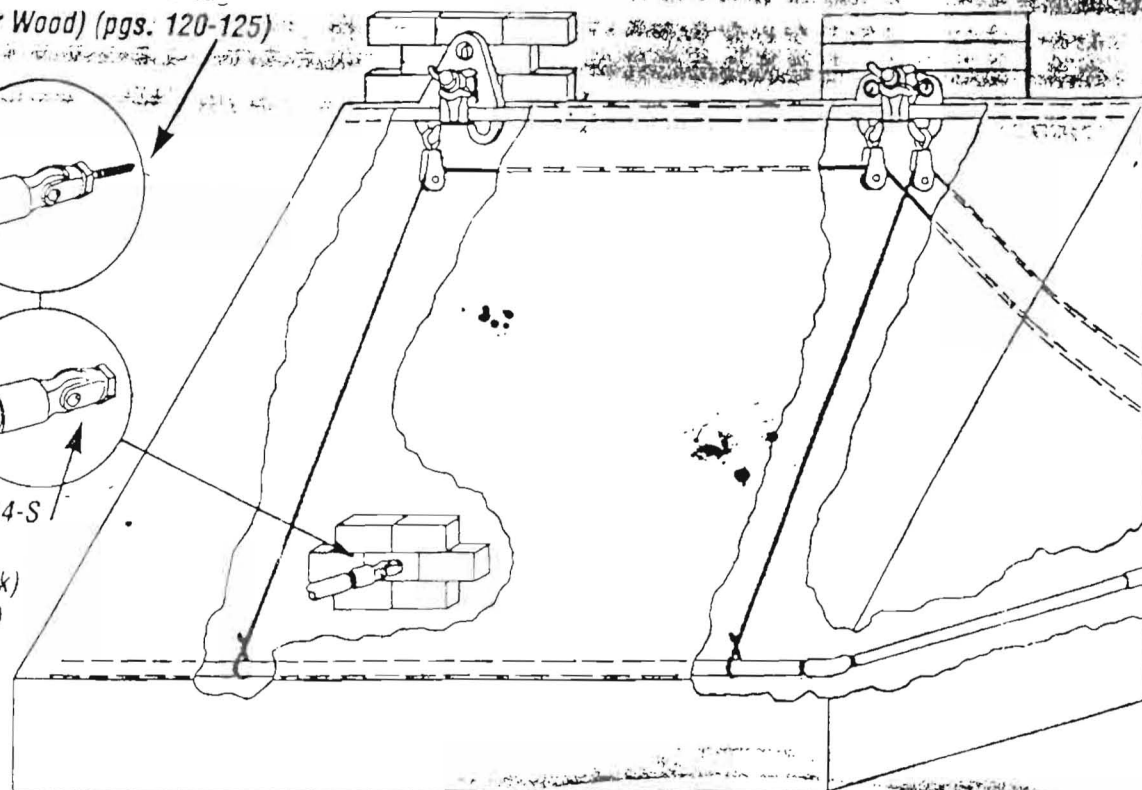

Store Awning

(detailing slide rod fittings)

ESTIMATE - CONTRACT

SOLD TO: Street & Co.
 DEL. ADDRESS 33 wharf St.
Portland, ME 04101
 MAIL ADDRESS _____

W.O.#	_____
JOB #	_____
DATE	<u>4/29/99</u>
EST. DEL. DATE	<u>3-4 weeks</u>
HOME PHONE	<u>775-4080</u>
BUS. PHONE	<u>775-0887</u>
FRAME STYLE	<u>1/2" sch. 40 pipe</u>
FABRIC & COLOR	<u>Sunbrella</u>
FABRIC STYLE #	<u>Firesist</u>

Manufacture and install 2 retractable awnings at 33 Wharf St.

Fabric: Sunbrella Firesist woven acrylic awning fabric. This has a 5 year manufacturers warranty. Color or pattern to be determined.

Frame: 1/2" galvanized sch. 40 pipe with all galvanized fittings.

Dimensions: 10'-0" x 36" tall x 72" projection.

* To be able to retract these awnings they will need to be drop arm slide rod assemblies. (see shop drawing).

Graphics: Lettering and or logos can be painted onto this fabric if so desired. I haven't included any cost estimate for graphics but would be happy to.

ITEM:	ESTIMATE
as above.....	\$1,485.00
Tax	\$66.00
ESTIMATE TOTAL	\$1,551.00
LESS DEPOSIT	50%
DUE UPON INSTALLATION	net

CONTRACT AGREEMENT

Maine Bay Canvas, Inc. agrees to sell, deliver and install to the Buyer, and the Buyer agrees to purchase and accept from Maine Bay Canvas, Inc. the above described goods or property, subject to and upon the terms and conditions hereof expressed. Any alteration or deviation from specifications involving extra costs will become an additional charge over and above the quote.

Until the said total balance is paid in full and all of the conditions hereof are fully performed title to and ownership of the property purchased under this contract shall be and remain the property of Maine Bay Canvas, Inc.

No cancellations will be accepted after work has started, or on special order merchandise. Delivery dates shown are approximate unless otherwise stated. Estimates do not include applicable taxes.

BUYER _____
 SELLER Don Haurin

Maine Bay Canvas
 53 Industrial Way
 Portland, Maine 04103
 207-878-8888

LAND-LOD Consent Form

WRITTEN CONSENT AND AGREEMENT RELATING TO A CERTAIN SIGN PROPOSED TO BE ERECTED ON A BUILDING AT 33 WHARF ST, IN PORTLAND, MAINE SOLETSKY LLC. being the owner of the premises at 424 FORE in Portland, Maine hereby gives consent to the erection of a certain sign owned by STREET + CO. over the public sidewalk or on the building from said premises as described in application to the Division of Inspection Services of Portland, Maine for a permit to cover erection of said sign:

And in consideration of the issuance of said permit _____, owner of said premises, in event said sign shall cease to serve the purpose for which it was erected or shall become dangerous and in event the owner of said sign shall fail to remove said sign or make it permanently safe in case the sign still serves the purpose for which it was erected, hereby agrees for himself or itself, for his heirs, its successors, and his or its assigns, to completely remove said sign within ten days of notice from said Inspector of Buildings that said sign is in such condition and of order from him to remove it.

In Witness whereof, the owner of said premises has signed this consent and agreement this 25th day of MAY 1999.

[Signature]
JOHN SOLETSKY
MEMBER, SOLETSKY LLC

05/15/99

ACORD CERTIFICATE OF LIABILITY INSURANCE

DATE (MM/DD/YY)
06/03/1999

PRODUCER (207)781-2784 FAX (207)781-2985
Desmond & Payne
366 US Route 1
Falmouth, ME 04105

THIS CERTIFICATE IS ISSUED AS A MATTER OF INFORMATION ONLY AND CONFERS NO RIGHTS UPON THE CERTIFICATE HOLDER. THIS CERTIFICATE DOES NOT AMEND, EXTEND OR ALTER THE COVERAGE AFFORDED BY THE POLICIES BELOW.

COMPANIES AFFORDING COVERAGE

Attn: Tracey Moore Ext: 117
INSURED
Street & Co Inc
& Nauset Associates dba Fore Street
33 Wharf Street
Portland, ME 04101

COMPANY A Hanover Insurance Company
COMPANY B
COMPANY C
COMPANY D

COVERAGES

THIS IS TO CERTIFY THAT THE POLICIES OF INSURANCE LISTED BELOW HAVE BEEN ISSUED TO THE INSURED NAMED ABOVE FOR THE POLICY PERIOD INDICATED, NOTWITHSTANDING ANY REQUIREMENT, TERM OR CONDITION OF ANY CONTRACT OR OTHER DOCUMENT WITH RESPECT TO WHICH THIS CERTIFICATE MAY BE ISSUED OR MAY PERTAIN, THE INSURANCE AFFORDED BY THE POLICIES DESCRIBED HEREIN IS SUBJECT TO ALL THE TERMS, EXCLUSIONS AND CONDITIONS OF SUCH POLICIES. LIMITS SHOWN MAY HAVE BEEN REDUCED BY PAID CLAIMS.

CO LTR	TYPE OF INSURANCE	POLICY NUMBER	POLICY EFFECTIVE DATE (MM/DD/YY)	POLICY EXPIRATION DATE (MM/DD/YY)	LIMITS
A	GENERAL LIABILITY <input checked="" type="checkbox"/> COMMERCIAL GENERAL LIABILITY <input checked="" type="checkbox"/> CLAIMS MADE <input checked="" type="checkbox"/> OCCUR OWNER'S & CONTRACTOR'S PROT	ZDP5326121-01	01/01/1999	01/01/2000	GENERAL AGGREGATE \$ 2,000,000 PRODUCTS - COMP/OP AGG \$ 2,000,000 PERSONAL & ADV INJURY \$ 1,000,000 EACH OCCURRENCE \$ 1,000,000 FIRE DAMAGE (Any one fire) \$ 50,000 MED EXP (Any one person) \$ 5,000
A	AUTOMOBILE LIABILITY <input checked="" type="checkbox"/> ANY AUTO <input checked="" type="checkbox"/> ALL OWNED AUTOS <input checked="" type="checkbox"/> SCHEDULED AUTOS <input checked="" type="checkbox"/> HIRED AUTOS <input checked="" type="checkbox"/> NON-OWNED AUTOS	ABP5326122-01	01/01/1999	01/01/2000	COMBINED SINGLE LIMIT \$ 1,000,000 BODILY INJURY (Per person) \$ BODILY INJURY (Per accident) \$ PROPERTY DAMAGE \$
	GARAGE LIABILITY <input type="checkbox"/> ANY AUTO				AUTO ONLY - EA ACCIDENT \$ OTHER THAN AUTO ONLY EACH ACCIDENT \$ AGGREGATE \$
A	EXCESS LIABILITY <input checked="" type="checkbox"/> UMBRELLA FORM OTHER THAN UMBRELLA FORM	UHP5542740-01	01/01/1999	01/01/2000	EACH OCCURRENCE \$ 1,000,000 AGGREGATE \$ 1,000,000 Retention \$ 10,000
A	WORKERS COMPENSATION AND EMPLOYERS' LIABILITY THE PROPRIETOR/PARTNERS/EXECUTIVE OFFICERS ARE: <input checked="" type="checkbox"/> INCL <input checked="" type="checkbox"/> EXCL OTHER	WDP5542489-01	01/01/1999	01/01/2000	WC STATUTORY LIMITS OTHER EL EACH ACCIDENT \$ 100,000 EL DISEASE - POLICY LIMIT \$ 500,000 EL DISEASE - EA EMPLOYEE \$ 100,000

DESCRIPTION OF OPERATIONS/LOCATIONS/VEHICLES/SPECIAL ITEMS
Fax to City of Portland (207) 775-4080

CERTIFICATE HOLDER

City of Portland
389 Congress Street
Portland, ME 04101

CANCELLATION

SHOULD ANY OF THE ABOVE DESCRIBED POLICIES BE CANCELLED BEFORE THE EXPIRATION DATE THEREOF, THE ISSUING COMPANY WILL ENDEAVOR TO MAIL 10 DAYS WRITTEN NOTICE TO THE CERTIFICATE HOLDER NAMED TO THE LEFT, BUT FAILURE TO MAIL SUCH NOTICE SHALL IMPOSE NO OBLIGATION OR LIABILITY OF ANY KIND UPON THE COMPANY, ITS AGENTS OR REPRESENTATIVES.

AUTHORIZED REPRESENTATIVE

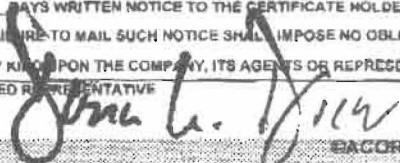

This form is only necessary if we do lettering on the

INFORMATION REQUIREMENTS FOR SIGN PERMIT APPLICATION

AWNING!

Applicants for a sign permit will be asked to submit the following information to the Code Enforcement Office:

1. Proof of insurance
2. Letter of permission from the owner
3. A sketch plan of lot, indicating location of buildings, driveways and any abutting streets or right of ways. Lengths of building frontages and street frontages should be noted. (see attached)
4. Indicate on the plan all existing and proposed signs
5. Computation of the following:
 - A) Sign area of each existing and proposed building sign
 - B) Sign area height and setback of each existing and proposed freestanding sign
6. A sketch of any proposed sign(s), indicating dimensions, materials, source of illumination and construction method (see attached).
7. Certificate of flammability required for awning/canopy at time of application.
8. UL # required for lighted signs at the time of application.

Fee for permit - \$25.00 plus \$0.20 per square foot

Fee for awning based on cost of work - \$25.00 for the first \$1,000.00, \$5.00 for each additional \$1,000.00.

NOTE: Once a sketch plan has been filed for a property, the code enforcement office will keep a record of the plan so that a new sketch plan will not be required for later changes to signage on the property. In such an instance, applicants will only be required to submit information applicable to the new sign.

SIGNAGE PRE-APPLICATION

PLEASE ANSWER ALL QUESTIONS

ADDRESS: 33 Wharf Street ZONE: B-3
OWNER: Solesky Limited
APPLICANT: Street + Company
ASSESSOR NO. 032-17-012

PLEASE CIRCLE APPROPRIATE ANSWER

SINGLE TENANT LOT? YES NO MULTI-TENANT LOT? YES NO
FREESTANDING SIGN? (ex. Pole Sign) YES NO --- DIMENSIONS _____ HEIGHT _____
MORE THAN ONE SIGN? YES NO DIMENSIONS _____ HEIGHT _____
SIGN ATTACHED TO BLDG.? YES NO DIMENSIONS _____
MORE THAN ONE SIGN? YES NO DIMENSIONS _____
AWNING: YES NO IS AWNING BACKLIT? YES NO HEIGHT OFF SIDEWALK 8ft
IS THERE ANY MESSAGE, TRADEMARK OR SYMBOL ON IT? _____

LIST ALL EXISTING SIGNAGE AND THEIR DIMENSIONS: _____

*** TENANT BLDG. FRONTAGE (IN FEET): _____
*** REQUIRED INFORMATION

AREA FOR COMPUTATION

YOU SHALL PROVIDE:

A SITE SKETCH AND BUILDING SKETCH SHOWING EXACTLY WHERE EXISTING AND NEW SIGNAGE IS LOCATED MUST BE PROVIDED. SKETCHES AND/OR PICTURES OF PROPOSED ARE ALSO REQUIRED.

SIGNATURE OF APPLICANT: Lynne Lian DATE: 6.3.99

BUILDING PERMIT REPORT

DATE: 24 June 99 ADDRESS: 33 Wharf ST. CBL: Ø32-N-Ø12
 REASON FOR PERMIT: Awnning
 BUILDING OWNER: SoleTSKY Limited Liability
 PERMIT APPLICANT: Maine Bay Canvas
 USE GROUP A-3 BOCA 1996 CONSTRUCTION TYPE 3B

CONDITION(S) OF APPROVAL

This permit is being issued with the understanding that the following conditions are met:

Approved with the following conditions: *1/

1. This permit does not excuse the applicant from meeting applicable State and Federal rules and laws.
2. Before concrete for foundation is placed, approvals from the Development Review Coordinator and Inspection Services must be obtained. (A 24 hour notice is required prior to inspection)
3. Foundation drain shall be placed around the perimeter of a foundation that consists of gravel or crushed stone containing not more than 10 percent material that passes through a No. 4 sieve. The drain shall extend a minimum of 12 inches beyond the outside edge of the footing. The thickness shall be such that the bottom of the drain is not higher than the bottom of the base under the floor, and that the top of the drain is not less than 6 inches above the top of the footing. The top of the drain shall be covered with an approved filter membrane material. Where a drain tile or perforated pipe is used, the invert of the pipe or tile shall not be higher than the floor elevation. The top of joints or top of perforations shall be protected with an approved filter membrane material. The pipe or tile shall be placed on not less than 2" of gravel or crushed stone, and shall be covered with not less than 6" of the same material. Section 1813.5.2
4. Foundations anchors shall be a minimum of 1/2" in diameter, 7" into the foundation wall, minimum of 12" from corners of foundation and a maximum 6' o.c. between bolts. (Section 2305.17)
5. Waterproofing and dampproofing shall be done in accordance with Section 1813.0 of the building code.
6. Precaution must be taken to protect concrete from freezing. Section 1908.0
7. It is strongly recommended that a registered land surveyor check all foundation forms before concrete is placed. This is done to verify that the proper setbacks are maintained.
8. Private garages located beneath habitable rooms in occupancies in Use Group R-1, R-2, R-3 or I-1 shall be separated from adjacent interior spaces by fire partitions and floor/ceiling assembly which are constructed with not less than 1-hour fire resisting rating. Private garages attached side-by-side to rooms in the above occupancies shall be completely separated from the interior spaces and the attic area by means of 1/2 inch gypsum board or the equivalent applied to the garage means of 1/2 inch gypsum board or the equivalent applied to the garage side. (Chapter 4, Section 407.0 of the BOCA/1996)
9. All chimneys and vents shall be installed and maintained as per Chapter 12 of the City's Mechanical Code. (The BOCA National Mechanical Code/1993). Chapter 12 & NFPA 211
10. Sound transmission control in residential building shall be done in accordance with Chapter 12, Section 1214.0 of the City's Building Code.
11. Guardrails & Handrails: A guardrail system is a system of building components located near the open sides of elevated walking surfaces for the purpose of minimizing the possibility of an accidental fall from the walking surface to the lower level. Minimum height all Use Groups 42", except Use Group R which is 36". In occupancies in Use Group A, B, H-4, I-1, I-2, M and R and public garages and open parking structures, open guards shall have balusters or be of solid material such that a sphere with a diameter of 4" cannot pass through any opening. Guards shall not have an ornamental pattern that would provide a ladder effect. (Handrails shall be a minimum of 3e4" but not more than 38". Use Group R-3 shall not be less than 30", but not more than 38".) Handrail grip size shall have a circular cross section with an outside diameter of at least 1 1/4" and not greater than 2". (Sections 1021 & 1022.0) - Handrails shall be on both sides of stairway. (Section 1014.7)
12. Headroom in habitable space is a minimum of 7'6". (Section 1204.0)
13. Stair construction in Use Group R-3 & R-4 is a minimum of 10" tread and 7 1/4" maximum rise. All other Use Group minimum 11" tread, 7" maximum rise. (Section 1014.0)
14. The minimum headroom in all parts of a stairway shall not be less than 80 inches. (6'8") 1014.4
15. Every sleeping room below the fourth story in buildings of Use Groups R and I-1 shall have at least one operable window or exterior door approved for emergency egress or rescue. The units must be operable from the inside without the use of special knowledge or separate tools. Where windows are provided as means of egress or rescue they shall have a sill height not more than 44 inches (1118mm) above the floor. All egress or rescue windows from sleeping rooms shall have a minimum net clear opening height dimension of 24 inches (610mm). The minimum net clear opening width dimension shall be 20 inches (508mm), and a minimum net clear opening of 5.7 sq. ft. (Section 1018.6)
16. Each apartment shall have access to two (2) separate, remote and approved means of egress. A single exit is acceptable when it exits directly from the apartment to the building exterior with no communications to other apartment units. (Section 1010.1)
17. All vertical openings shall be enclosed with construction having a fire rating of at least one (1) hour, including fire doors with self closer's. (Over 3 stories in height requirements for fire rating is two (2) hours.) (Section 710.0)
18. The boiler shall be protected by enclosing with (1)hour fire rated construction including fire doors and ceiling, or by providing automatic extinguishment. (Table 302.1.1)
19. All single and multiple station smoke detectors shall be of an approved type and shall be installed in accordance with the provisions of the City's Building Code Chapter 9, Section 920.3.2 (BOCA National Building Code/1996), and NFPA 101 Chapter 18 & 19. (Smoke detectors shall be

installed and maintained at the following locations):

- In the immediate vicinity of bedrooms
- In all bedrooms
- In each story within a dwelling unit, including basements

In addition to the required AC primary power source, required smoke detectors in occupancies in Use Groups R-2, R-3 and I-1 shall receive power from a battery when the AC primary power source is interrupted. (Interconnection is required) Section 920.3.2.

20. A portable fire extinguisher shall be located as per NFPA #10. They shall bear the label of an approved agency and be of an approved type. (Section 921.0)
21. The Fire Alarm System shall maintained to NFPA #72 Standard.
22. The Sprinkler System shall maintained to NFPA #13 Standard.
23. All exit signs, lights and means of egress lighting shall be done in accordance with Chapter 10 Section & Subsections 1023.0 & 1024.0 of the City's Building Code. (The BOCA National Building Code/1996)
24. Section 25-135 of the Municipal Code for the City of Portland states, "No person or utility shall be granted a permit to excavate or open any street or sidewalk from the time of November 15 of each year to April 15 of the following year".
25. The builder of a facility to which Section 4594-C of the Maine State Human Rights Act Title 5 MRSA refers, shall obtain a certification from a design professional that the plans commencing construction of the facility, the builder shall submit the certification the Division of Inspection Services.
26. Ventilation shall meet the requirements of Chapter 12 Sections 1210.0 of the City's Building Code. (Crawl spaces & attics).
27. All electrical, plumbing and HVAC permits must be obtained by a Master Licensed holders of their trade. No closing in of walls until all electrical (min. 72 hours notice) and plumbing inspections have been done.
28. All requirements must be met before a final Certificate of Occupancy is issued.
29. All building elements shall meet the fastening schedule as per Table 2305.2 of the City's Building Code (the BOCA National Building Code/1996).
30. Ventilation of spaces within a building shall be done in accordance with the City's Mechanical Code (The BOCA National Mechanical Code/1993). (Chapter M-16)
31. Please read and implement the attached Land Use Zoning report requirements.
32. Boring, cutting and notching shall be done in accordance with Sections 2305.4.4, 2305.5.1 and 2305.5.3 of the City's Building Code.
33. Glass and glazing shall meet the requirements of Chapter 24 of the building code.
34. All awning shall be erected in accordance with section 3205.0 of the City's bldg. Code.
35. _____
36. _____

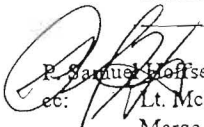
R. Samuel Hoffses, Building Inspector
cc: Lt. McDougall, PFD
Marge Schmuckal, Zoning Administrator

PSH 12-14-98

**On the basis of plans submitted and conditions placed on these plans any deviations shall require a separate approval.

contacts!

call for haircut

call O'Donnell's about
Astoria Drive

Mam!