



SITELINE™

WOOD & CLAD-WOOD
WINDOWS & PATIO DOORS

JELD-WEN
WINDOWS & DOORS



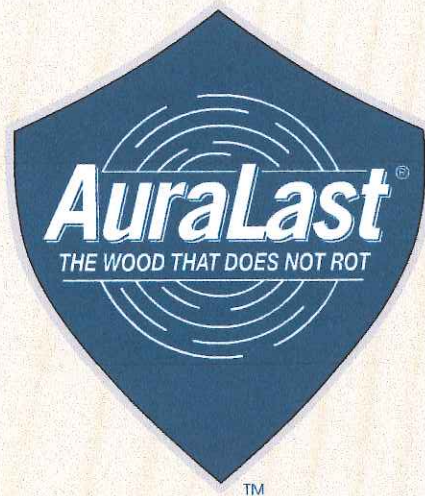

AuraLast® wood protects against wood rot for as long as you own and occupy your home. Guaranteed.

**LIFETIME
LIMITED
WARRANTY**

Guaranteed Protection Against Wood Rot

JELD-WEN® wood windows and patio doors made with exclusive pine AuraLast wood are guaranteed not to rot for as long as you own and occupy your home. Wood components made from AuraLast wood maintain their structural integrity even in the toughest climates. [Visit jeld-wen.com](http://jeld-wen.com) to view the full warranty.*

**100%
PROTECTION**

Surface-to-Core Protection

Because of our vacuum/pressure process, AuraLast wood provides virtually 100% penetration of the protective ingredients. Other manufacturers use submersion/dip-treatment methods, which only protect the outer surface of the wood.

**100%
WOOD**

Working With AuraLast Wood is Easy

AuraLast offers the strength and beauty of real wood because it is real wood, not a composite. AuraLast wood is colorless, stainable and odorless.

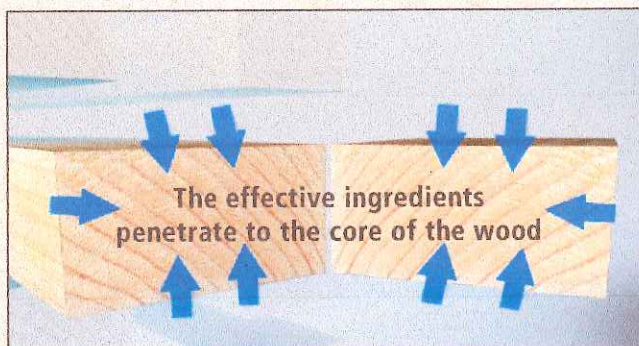

Virtually 100% Surface-to-Core Protection

**100%
WORRY-FREE**

AuraLast is Safe

AuraLast wood is made by using a water-based solution to deliver the effective ingredients to the core of the wood. Traditional dip-treatments use a solvent-based chemical bath. During production our AuraLast process releases 96% fewer volatile organic compounds than the traditional dip-treatment method.



Traditional treatments only protect the outer surface

A JELD-WEN Exclusive

Only JELD-WEN makes window and door products with natural pine AuraLast wood that are built to last.

Protects Against Water Saturation

AuraLast wood offers superior resistance to water saturation, which protects against swelling that causes windows and doors to stick.

Protects Against Termites

Harmful termites will eat through unprotected wood—not so with AuraLast wood.

[Visit jeld-wen.com/auralast](http://jeld-wen.com/auralast) for more information

***AuraLast Lifetime Limited Warranty Coverage
for Wood Decay and Termite Damage**

JELD-WEN products made from pine AuraLast wood will not rot.

Engineered for High Performance

A commitment to excellence and innovation inspired our new Sitrine® wood windows and patio doors. Each door and window is designed for ease of operation, low maintenance and beauty that stands the test of time.

Energy Efficiency Designed to Last

Can a door or window be called high-performance? Definitely. Sitrine wood windows and patio doors meet or exceed 2016 ENERGY STAR® 6 requirements and offer increased thermal performance and weather resistance with outstanding energy advantages. Our thermally improved engineered sill and frame designs feature innovative advancements for added energy efficiency and durability.

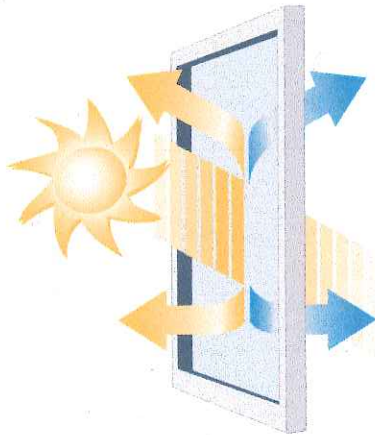

In warm weather, LoE³-366 glass reflects the sun's energy and prevents it from entering the home.

In cold weather, LoE³-366 glass reduces the amount of heat lost by reflecting it back inside.



With Neat® glass, you gain natural cleaning convenience. Neat glass harnesses the sun's UV rays (even when the sky is cloudy) to loosen dirt from the glass so rainwater can easily rinse away the grime. No manual activation is required.

Architectural Enrichment

Whether it's new construction, renovation, traditional or modern, JELD-WEN offers a style that fits your needs. We make it easy to enhance a home with depth and definition that complements your project. Detail updates such as the recessed sash on the casement and our double-hung concealed jamb liner add architectural flair and aesthetic appeal with clean, smooth, contemporary lines. Regardless of the climate where you live, we offer the products you need, with larger unit sizes and expanded design options.

Clearly Better

All Sitrine wood windows and patio doors come with LoE³-366® glass, which blocks infrared rays, so you'll stay cooler in the summer and warmer in the winter. Only JELD-WEN Sitrine wood products come standard with LoE³-366 and Neat® glass. ENERGY STAR® certified versions of Sitrine wood products are available with energy efficient options, including argon-filled or high-altitude glass.

Fit Plus Finish

A wide range of colors, hardware and hardware finishes help you make the statement you want, right down to the last detail. Our many clad color finishes are guaranteed not to chalk or fade for 10 years, even in coastal environments. Optional anodized finishes bring extra durability, and nine interior finish options make it easy to coordinate your Sitaline products with your home's trim, cabinetry and furnishings. Decorative glass choices, divided lites and multiple screen options offer styles ranging from contemporary to classic.

Great Views Inside and Out

Your home is as unique as you are. Sitaline wood windows and patio doors offer many ways to help you save energy without compromising on design and style. JELD-WEN wood products provide the beauty, options and long-lasting performance that you and your family deserve. We wouldn't have it any other way.



DOUBLE-HUNG WINDOWS

JELD-WEN double-hung windows offer a traditional style. They feature an upper and lower sash that can slide vertically past each other in a single frame and have a concealed jamb liner, providing a clean and architecturally focused look. Both sash tilt in for convenient cleaning.

These windows feature an optional 3-1/2" bottom rail with optional finger plow and a top rail with optional finger routes.

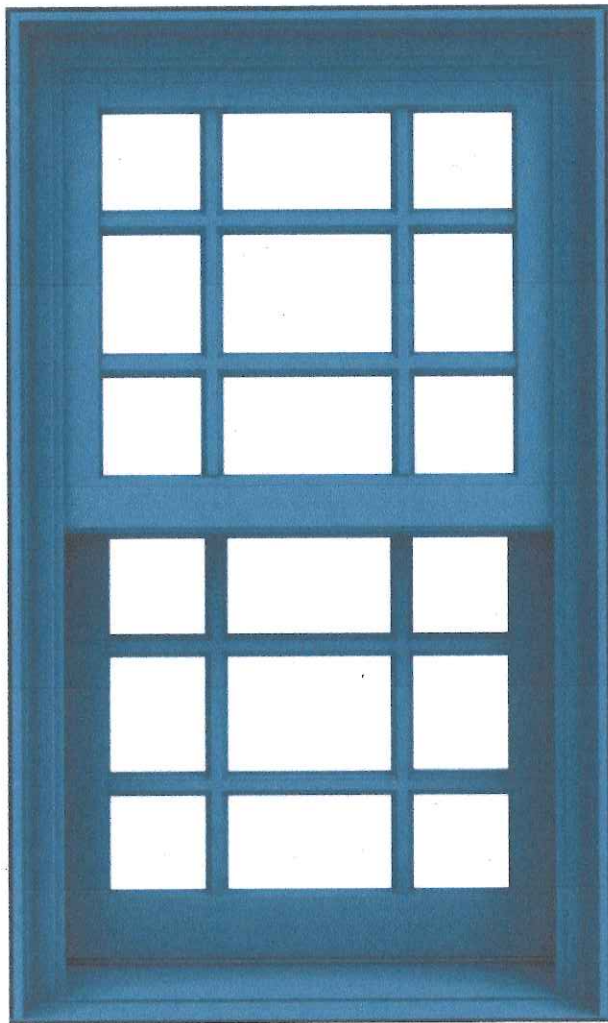

Beneath the low-profile exterior are several engineering and design cues that will keep these windows operating smoothly for years to come. See dealer for additional product details and ordering information.

OPTIONAL DESIGNS

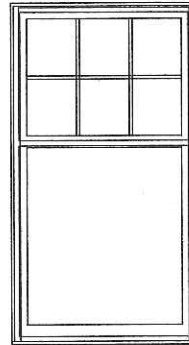

COTTAGE

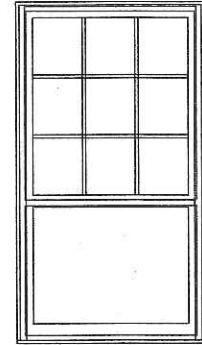

REVERSE COTTAGE

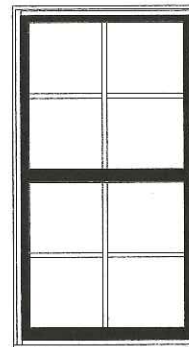

HYBRID
WOOD FRAME/
CLAD SASH

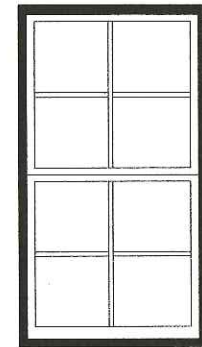

HYBRID
CLAD FRAME/
WOOD SASH

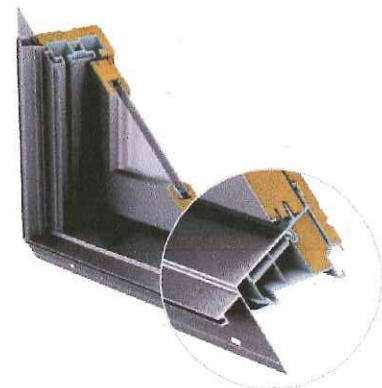

CHAMBERED COMPOSITE INTERIOR SILL

- Added strength
- Space in chambers acts as thermal break



Concealed Jamb Liner
provides a clean
uniform appearance

TILT FEATURE

Ease of maintenance is built right into our double-hung windows. Simply slide in the tabs and tilt the sash in. No more climbing ladders to wash the windows.

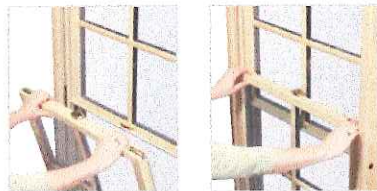



SEGMENT TOP AND RADIUS TOP RAIL WINDOWS

Some rooms call for more than a typical window configuration. A JELD-WEN® segment top window offers a unique shape to accent any home and has an operating bottom sash. On the radius top rail window, both sashes easily slide up and down to provide ventilation.

A variety of styles, colors and hardware add to the elegance of this window. See dealer for additional product details and ordering information.

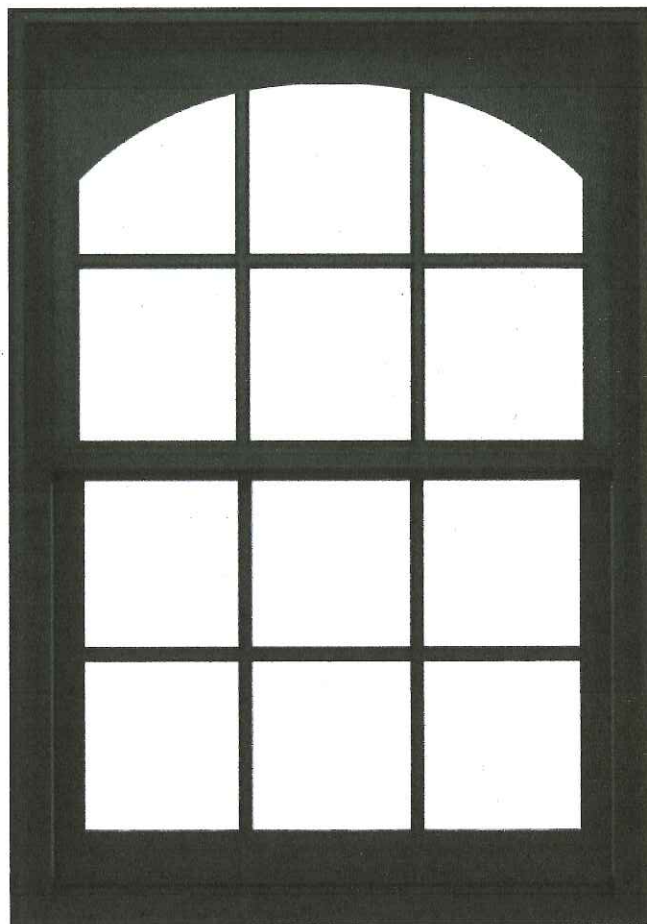

INTERIOR OPTIONS

Let's start on the inside. Here, you can choose your wood type, finish and trim options.

INTERIOR WOOD OPTIONS

Increase a home's sense of visual harmony by choosing one of our interior wood options to coordinate with trim, cabinetry and furnishings. In addition to AuraLast® wood pine or primed we offer mixed grain Douglas fir, or alder, a grain that blends well with cherry, maple or birch.



STANDARD INTERIOR FINISHES*

Custom options available.

- | | |
|--------------------|--------------|
| 1. BRILLIANT WHITE | 6. CIDER |
| 2. IVORY | 7. FRUITWOOD |
| 3. DESERT SAND | 8. CORDOVAN |
| 4. CLEAR LACQUER | 9. WALNUT |
| 5. WHEAT | |



INTERIOR TRIM

Interior radius casings are available in pine for radius windows and patio doors. These casings come in several patterns.

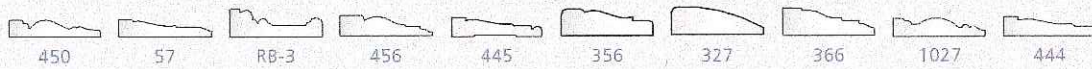

INTERIOR GLAZING STOPS

Our Traditional sash profile replicates the look of an historical putty glazed window. The optional Contemporary profile brings a simple clean line for modern interior design.

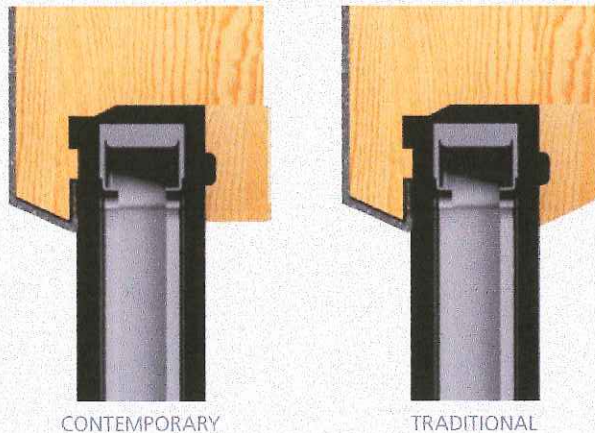

EXTERIOR OPTIONS

This is where you decide what your door or window will look like from the outside of your home. Custom colors are available or upgrade your standard color to include PVDF protection against color fade with a 10-Year Limited Warranty.

STANDARD CLAD COLORS



OPTIONAL CLAD COLORS



ANODIZED FINISH COLORS*



EXTERIOR WOOD OPTIONS



AURALAST® WOOD
PINE OR PRIMED

EXTERIOR TRIM

PRIMED WOOD

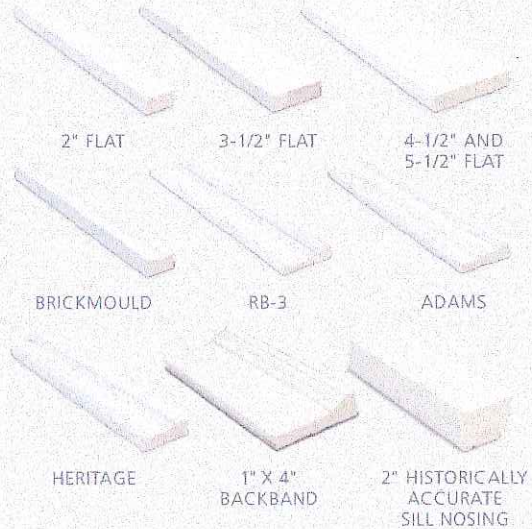

CLAD

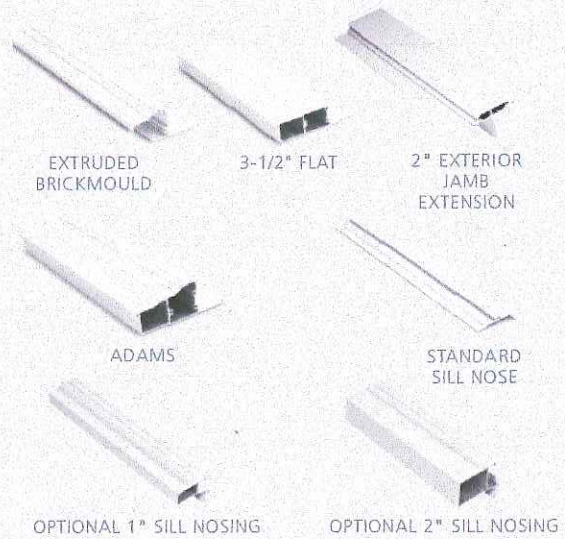

GLASS OPTIONS

Here you can choose from a variety of styles to make glass much more than just transparent.

TINTED GLASS

Tinted glass reduces glare, and is ideal for areas that get a lot of direct sunlight in the summer. We offer green, grey, bronze, reflective grey and reflective bronze tinted glass.



TEXTURED GLASS

Let light in while maintaining privacy with textured glass. We offer a wide range of textures to meet your aesthetic preferences. Five of our most popular choices are shown here.



SPACER BAR

For even more versatility spacer bar color options enhance the appearance of your windows.



ENERGY SAVING GLASS OPTIONS

LOE³-366[®] AND LoE EC INSULATING GLASS

Our standard high-performance LoE³-366 insulating glass enhances energy conservation by helping homes stay cooler in the summer and warmer in the winter. LoE³-366 provides more protection against solar heat gain, reduces condensation and helps limit fading of interior furnishings. For even more protection choose LoE EC. It improves thermal performance and is the optimal solution for ENERGY STAR[®] in certain regions of the country.

NEAT[®] GLASS

This is a natural cleaning convenience that comes standard for all Sitrine wood and clad-wood windows and patio doors. By harnessing the sun's UV rays to loosen dirt from the glass, rainwater can easily rinse away grime. No manual activation is required.



ENERGY STAR[®]

Many JELD-WEN[®] windows and doors are ENERGY STAR certified, which means they exceed the minimum energy efficiency criteria for the climate region in which you live. JELD-WEN has been a proud ENERGY STAR partner for over a decade.

PRESERVE[®] PROTECTIVE FILM

Standard for all Sitrine[®] wood and clad-wood windows and patio doors, this film is factory-applied to both sides of the glass. It protects against debris and scratches during shipping and handling or at a construction site. It's easy to remove and saves cleanup time after installation.

TEMPERED GLASS

This type of glass is treated with heat, so it can withstand greater force or pressure on its surface, and it will not break into sharp pieces. This is mostly used on patio doors or windows that are installed near floor level.

DIVIDED LITES

Add architectural interest to your JELD-WEN® Sitrine® wood and clad-wood windows with one of our decorative grille options. These options include Simulated Divided Lites (SDL) for an authentic look, Full-Surround (FS) wood grilles that can be removed for easy cleaning, and maintenance-free Grilles Between the Glass (GBG).

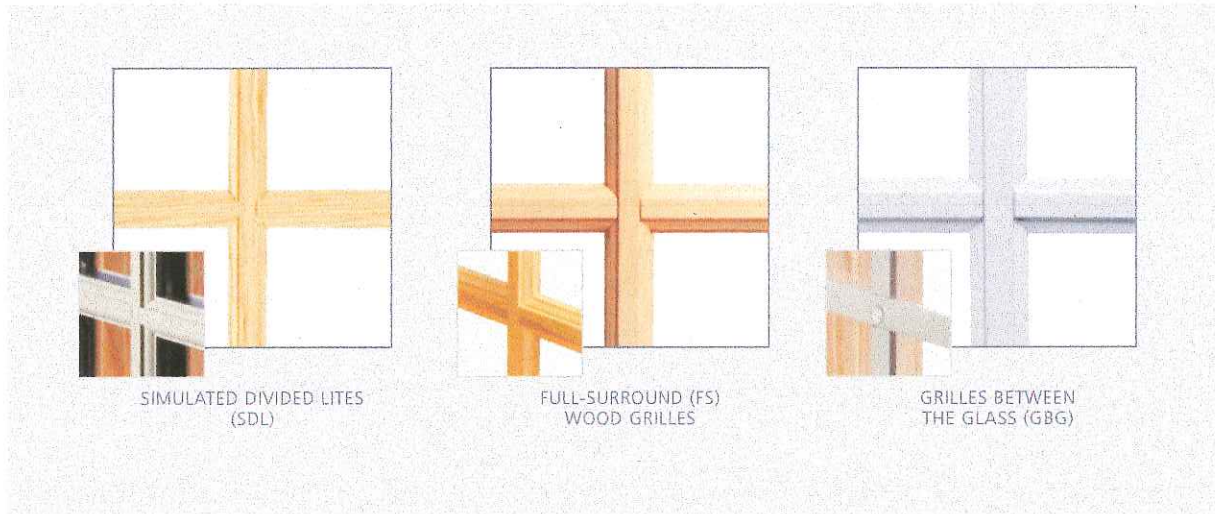

SIMULATED DIVIDED LITES (SDL)

FULL-SURROUND (FS) WOOD GRILLES

GRILLES BETWEEN THE GLASS (GBG)

SIMULATED DIVIDED LITES (SDL)

Our permanently attached wood grilles create a truly authentic look. Grilles are adhered to the interior glass while exterior grille options include aluminum for clad wood or wood for primed wood. The optional light brown or silver shadow bars are placed between the two panes of insulating glass to complete the effect. Interior and exterior SDLs are available in decorative beaded or subtle putty profiles (shown to the right).

FULL-SURROUND (FS) WOOD GRILLES

Enjoy low-maintenance beauty with our full-surround wood grilles that can be removed for easy cleaning. Choose from 7/8", 1-1/8" or 1-3/8" grilles that are positioned on the interior glass surface.

GRILLES BETWEEN THE GLASS (GBG)

This option provides style without the upkeep. Select 5/8" flat or 23/32" or 1" contour metal grilles in many of our clad colors.



Decorative grilles are also available in woodgrain finishes.

SCREEN TECHNOLOGY

Today's screen options are capable of much more than keeping out insects. Here you'll find an option that's right for you.

PHANTOM SCREENS® TECHNOLOGY

These retractable screens provide wide-open views when you want them or breezy protection from the outdoors when you need it. They're durable and easy to operate. Phantom Screens are available on awning, casement and double-hung windows. Screens for double-hung windows also have a removable track that allows the sash to tilt in for easy cleaning.

SCREEN OPTIONS*

Let the natural light flood in while keeping insects at bay. With a fine, black fiberglass mesh and light gloss finish, BetterVue® insect screens are now standard for awning, casement, double-hung and horizontal sliding windows. UltraVue®, fiberglass, and aluminum mesh screens are available in charcoal or silver finishes.

PATIO DOOR SCREENS

As on our windows, BetterVue screens are standard on patio doors. However, you can also choose from bottom rolling extruded (both regular and heavy-duty), or a top-hanging screen.

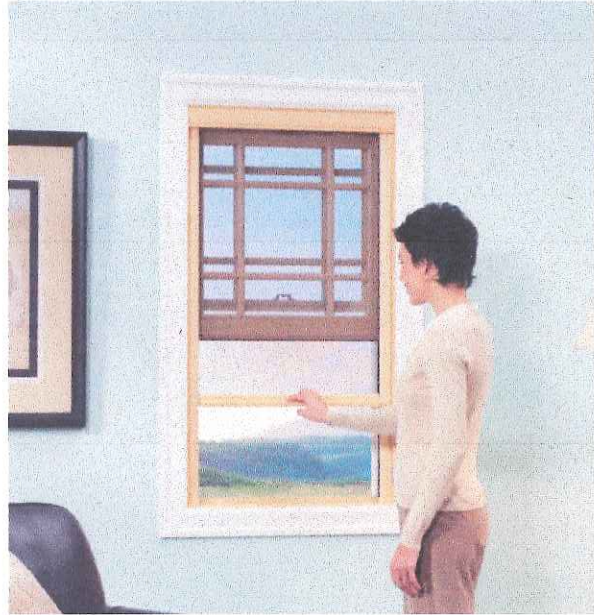

SWINGING SCREEN

Historically detailed swinging screen for push-out casement and awning windows matches wood and hardware finishes. See image on page 13.



REGULAR SCREEN

VIEW THROUGH REGULAR FIBERGLASS INSECT SCREEN

BETTERVUE® SCREEN

VIEW THROUGH BETTERVUE® INSECT SCREEN (STANDARD)

ULTRAVUE® SCREEN

VIEW THROUGH OPTIONAL ULTRAVUE® INSECT SCREEN

*Insect screens are intended to allow air and light in, while keeping insects out. They are not intended to stop children from falling through an open door or window. For safety screens and other security devices, contact your local building supply retailer.



CLEAR OPENING

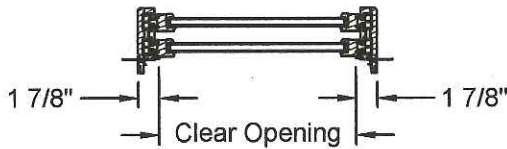

Double-Hung
Clear Opening Formula
Vertical
 $(\text{Frame Height} / 2) - 3 \frac{5}{8}'' = \text{Clear Opening}$
HORIZONTAL
 $\text{Frame Width} - 3 \frac{3}{4}'' = \text{Clear Opening}$

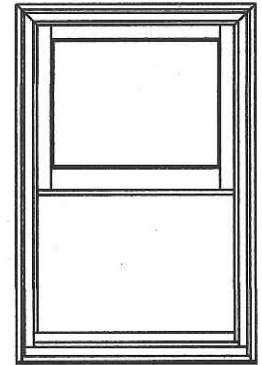

Double-Hung Window

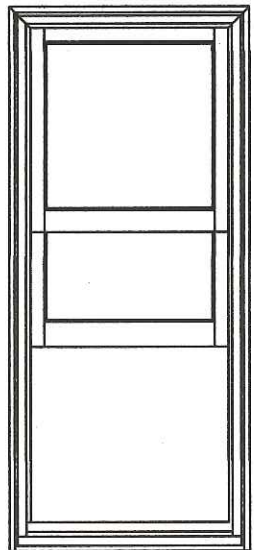
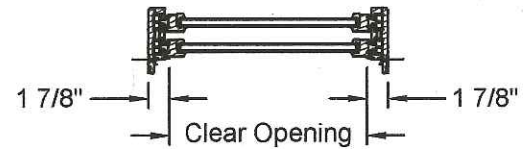
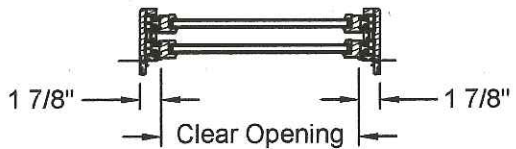
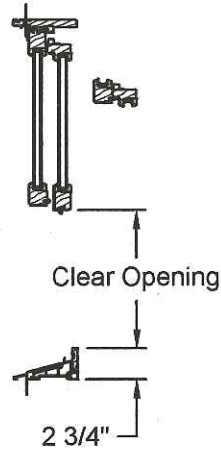

Cottage Window

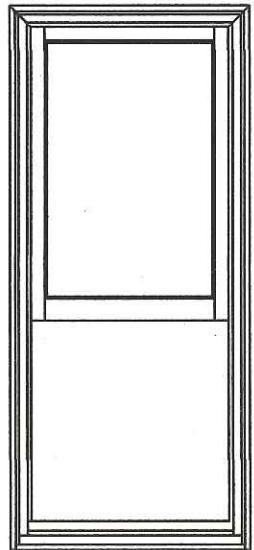
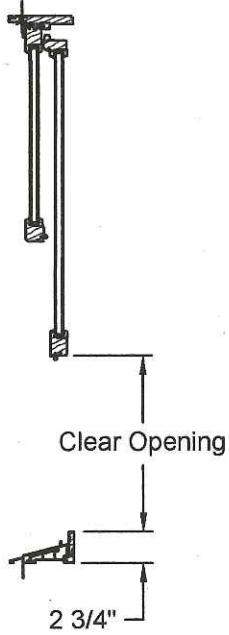

Reverse Cottage Window

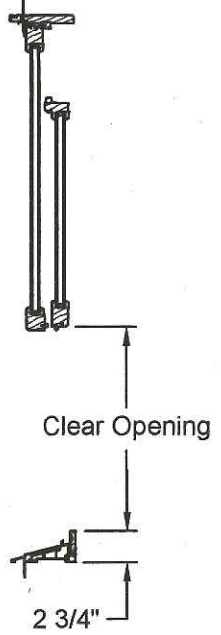

Cottage & Reverse Cottage
Consult the Design Data Tables for clear opening information. For dimensional units, contact Jeld-Wen - Hawkins Window Division, Technical Services Department for clear opening information.



UNIT SIZING

General Notes:

Unit size is always the maximum size of the window with or without trim and does not include nail fin.

Masonry Opening:

Masonry opening is always 1/2" over (height and width) the unit size or the outside of the trim of the window.

Rough Opening:

Rough opening is always 3/4" over frame size of the window.

Horizontal exterior trim offerings below are the same with or without sill nosing.

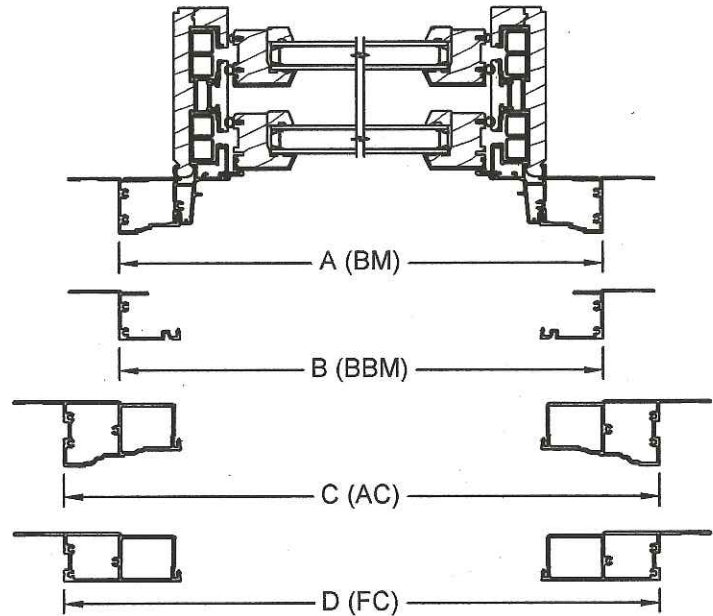

Horizontal Sections		
Trim Option	Dimension	Frame +
Brickmould (BM)	A	3"
Beaded Brickmould (BBM)	B	3"
Adams Casing (AC)	C	6"
3 1/2" Flat Casing (FC)	D	6"

Vertical exterior trim offerings with standard sill nosing. Trim on 3 sides.

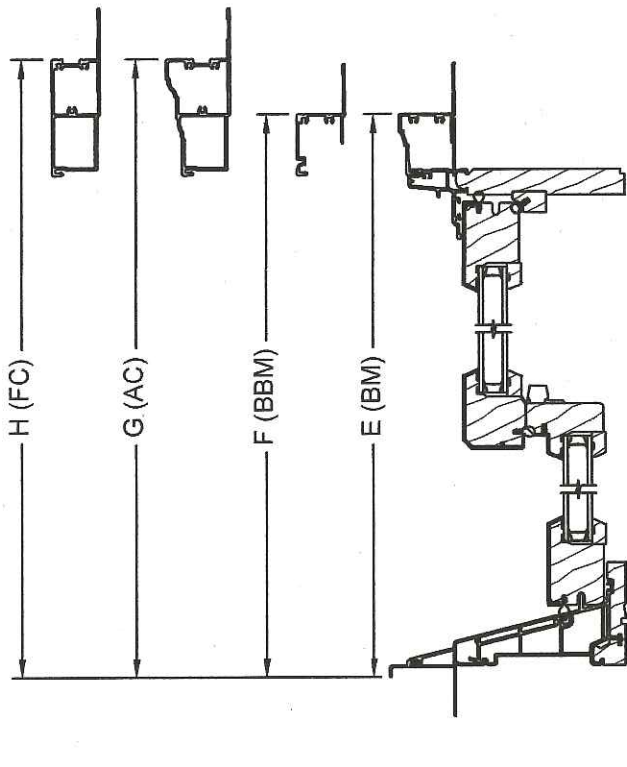

Vertical Sections (w/ Sill Nose)		
Trim Option	Dimension	Frame +
Brickmould (BM)	E	1-13/16"
Beaded Brickmould (BBM)	F	1-13/16"
Adams Casing (AC)	G	3-5/16"
3 1/2" Flat Casing (FC)	H	3-5/16"



OPERATION AND SASH TILT

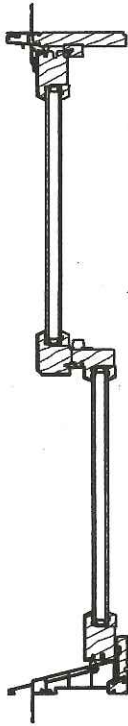

Double-Hung Operation:
When the sash are locked at the check rails the sash are closed and sealed in the sash opening of the frame.

When the sash are unlocked the lower sash travels vertically to any position desired. The upper sash can also be positioned as desired.

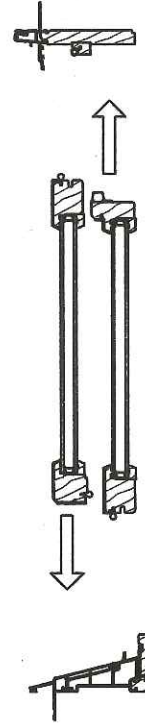

Sash Tilting for Washing

The Siteline Double-Hung window will allow the sash to be tilted or removed for easy cleaning.

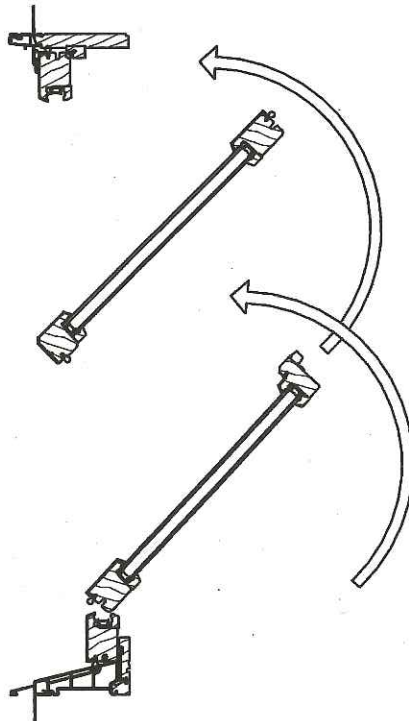



DIVIDED LITE OPTIONS

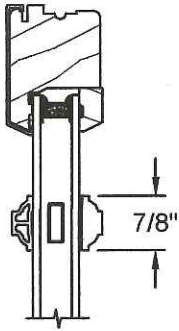

7/8"
Bead SDL

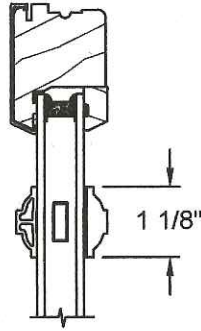

1 1/8"
Bead SDL

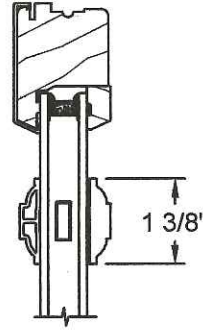

1 3/8"
Bead SDL

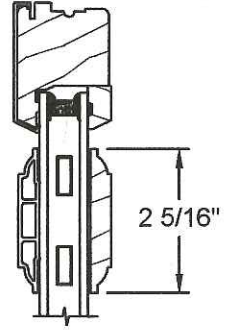

2 5/16"
Bead SDL

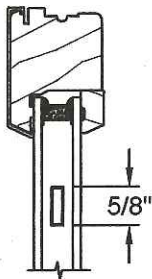

5/8" GBG

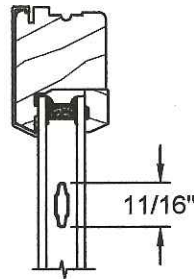

23/32" Contour
GBG

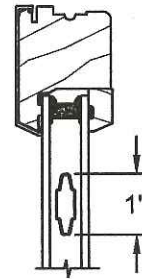

1" Contour
GBG

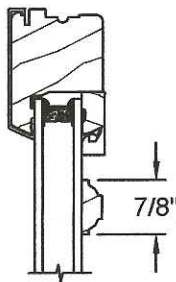

Full Surround
7/8" Wood
Grille

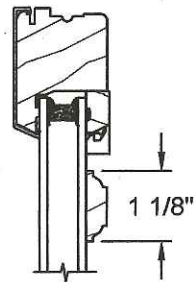

Full Surround
1 1/8" Wood
Grille

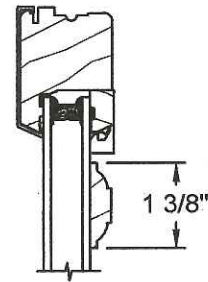

Full Surround
1 3/8" Wood
Grille



DIVIDED LITE OPTIONS

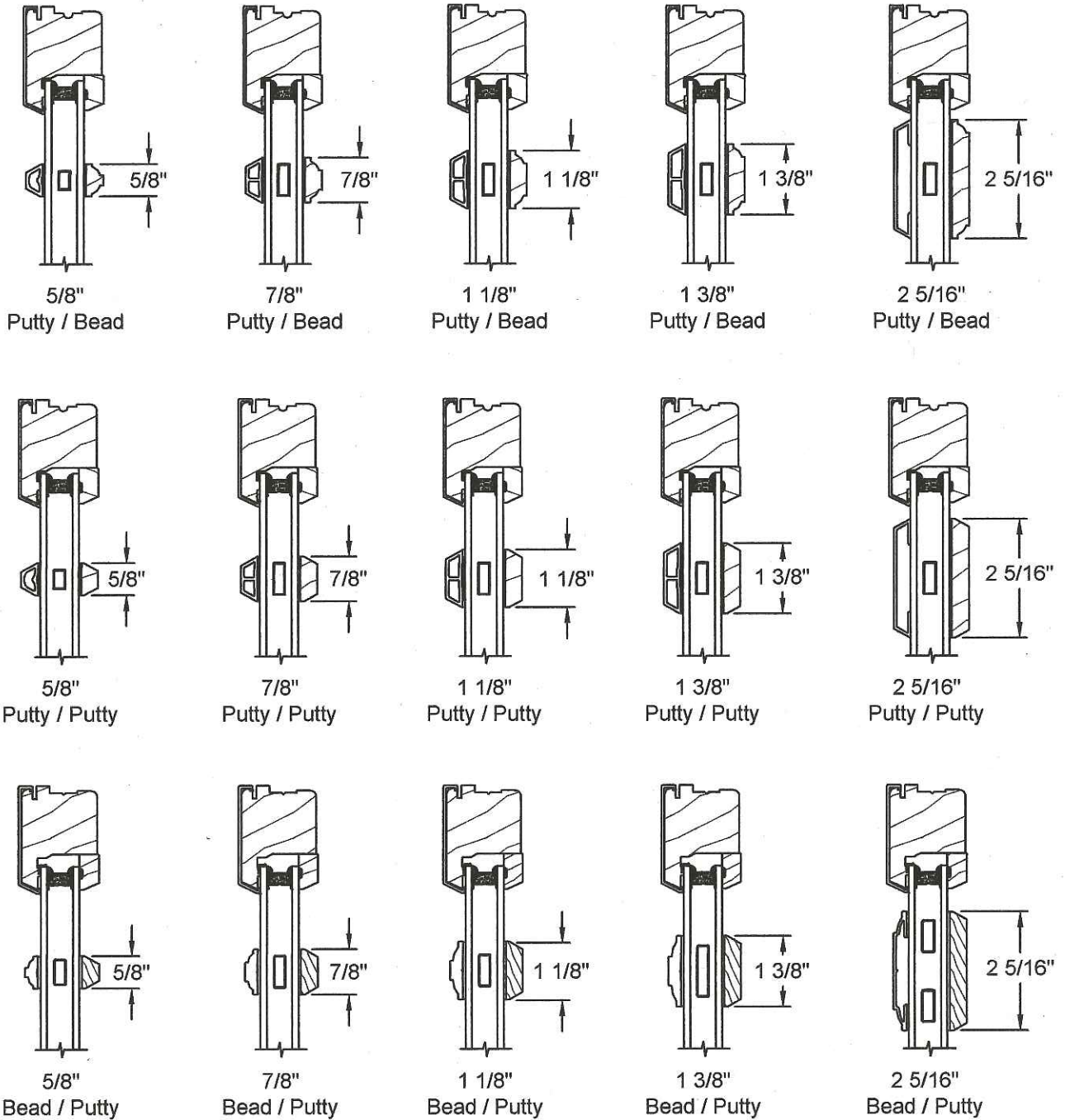



TRIM AND SILL OPTIONS

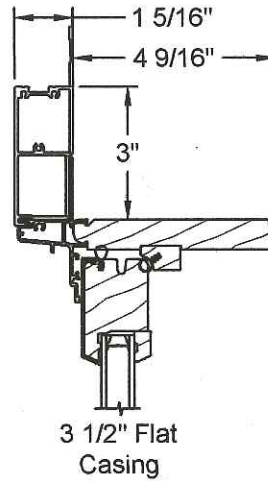
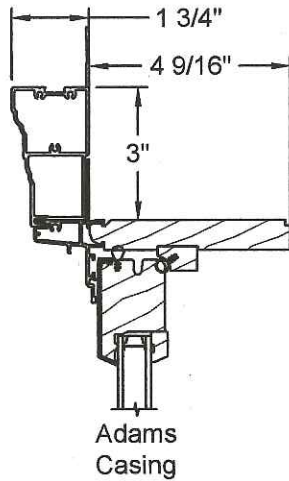
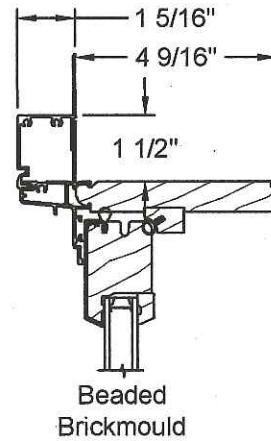
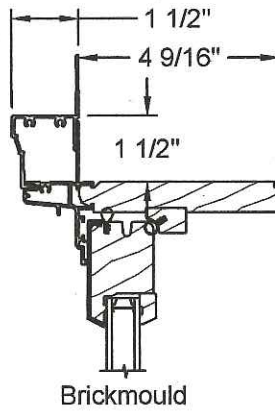
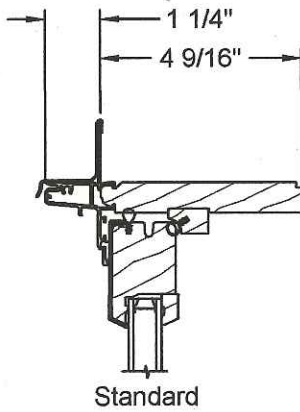

Sill Options

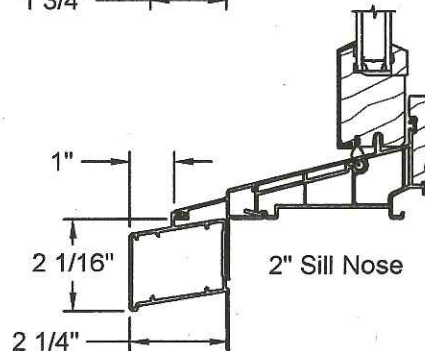
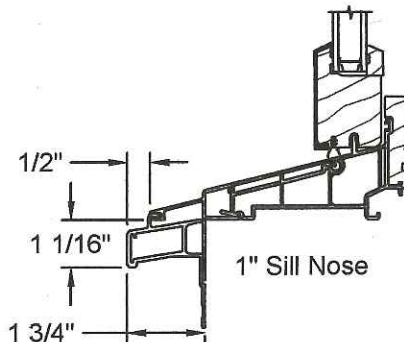
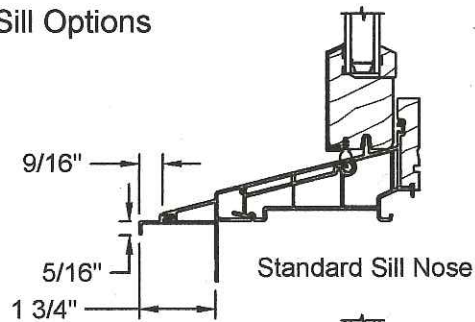



OPERATOR - VERTICAL SECTION

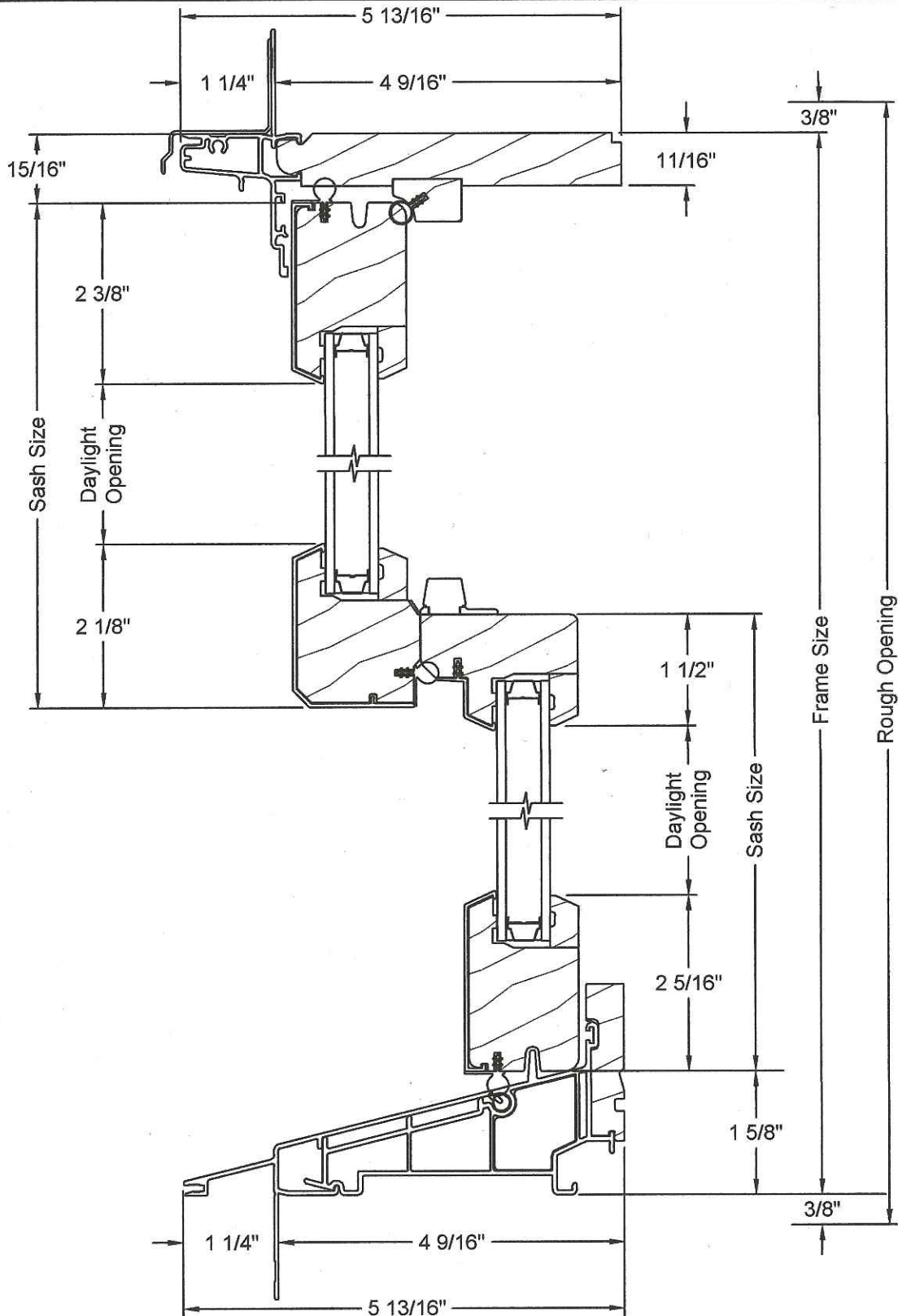



OPERATOR - HORIZONTAL SECTION

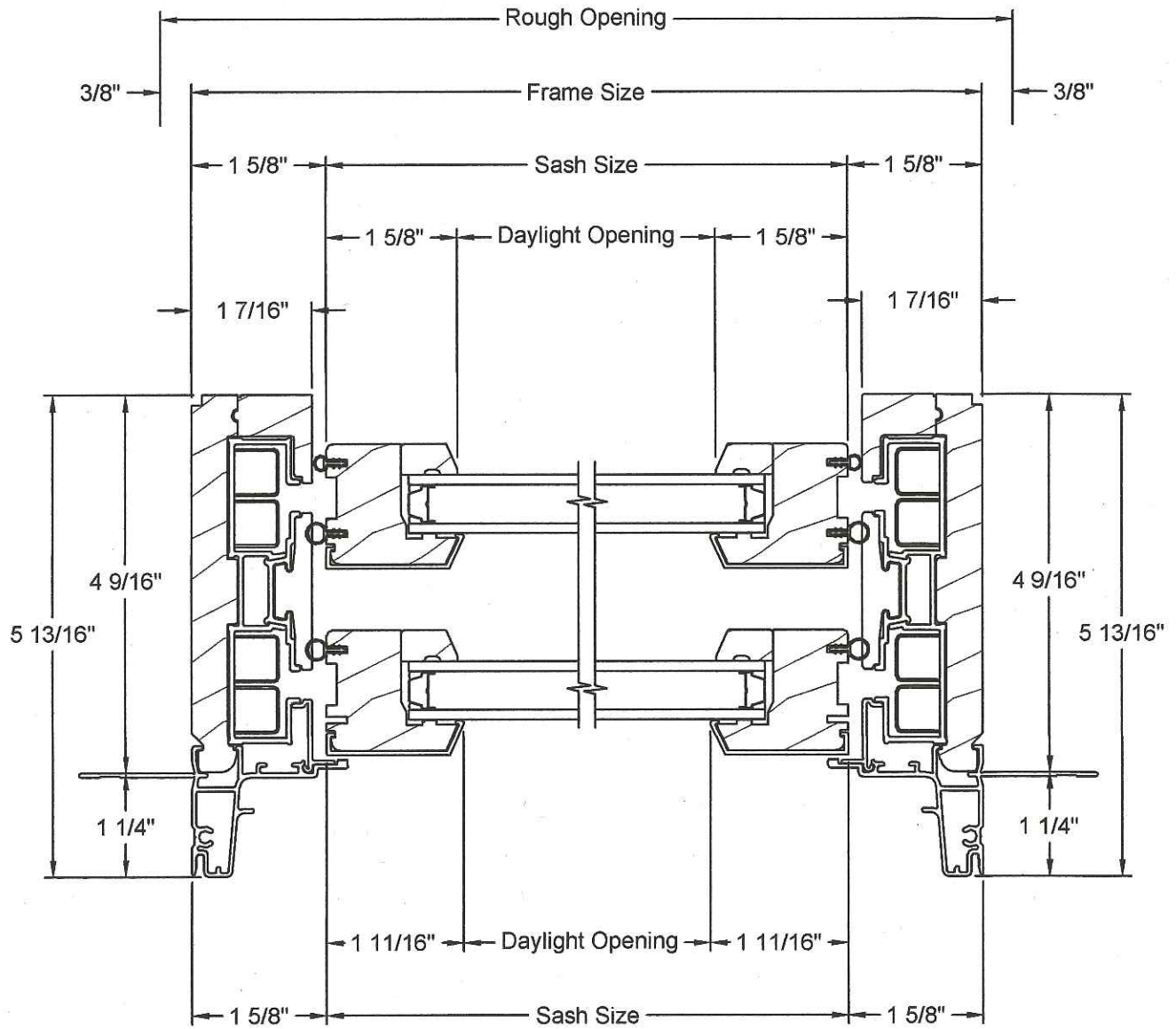



IMPACT OPERATOR - VERTICAL SECTION

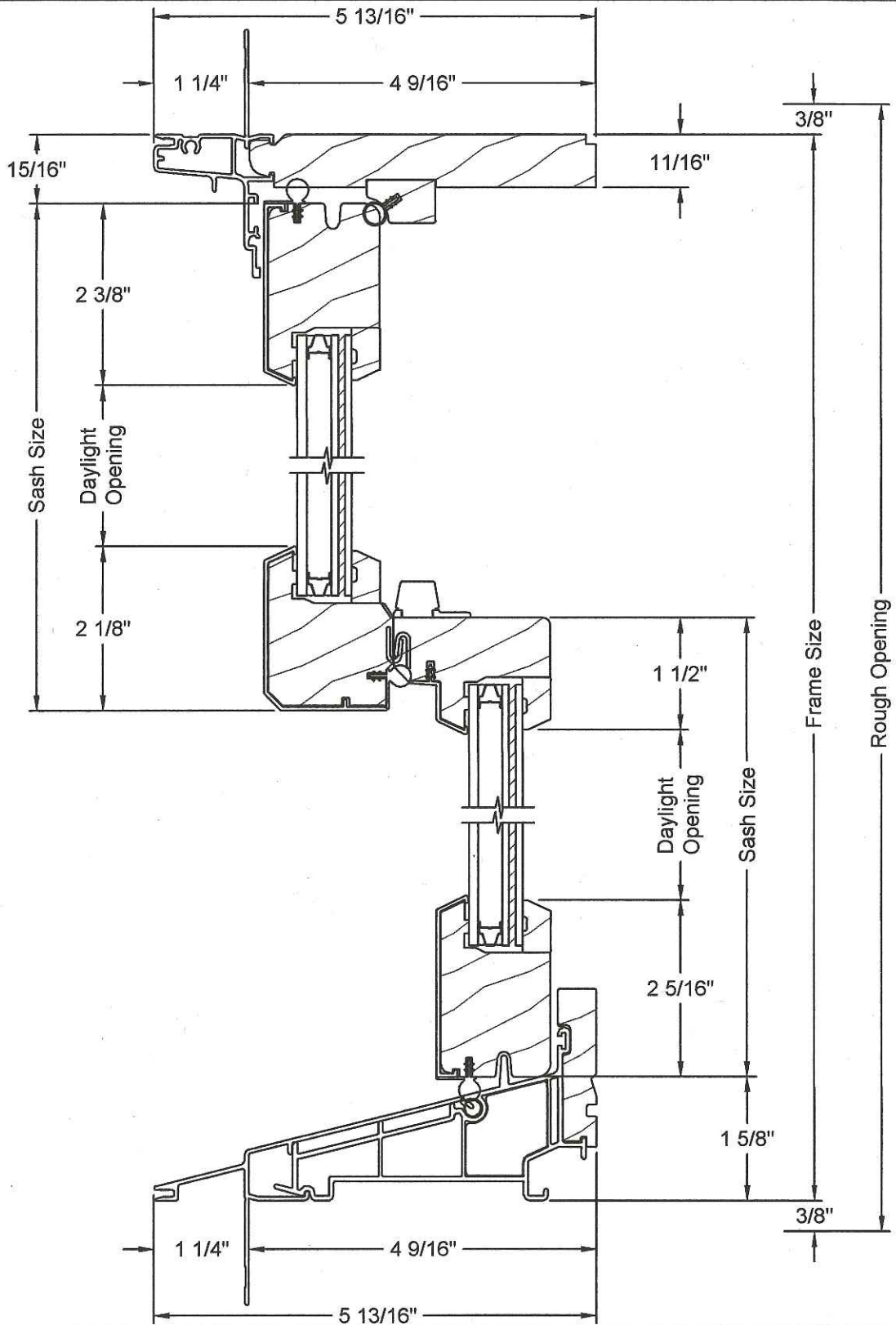



RADIUS TOP - VERTICAL SECTION

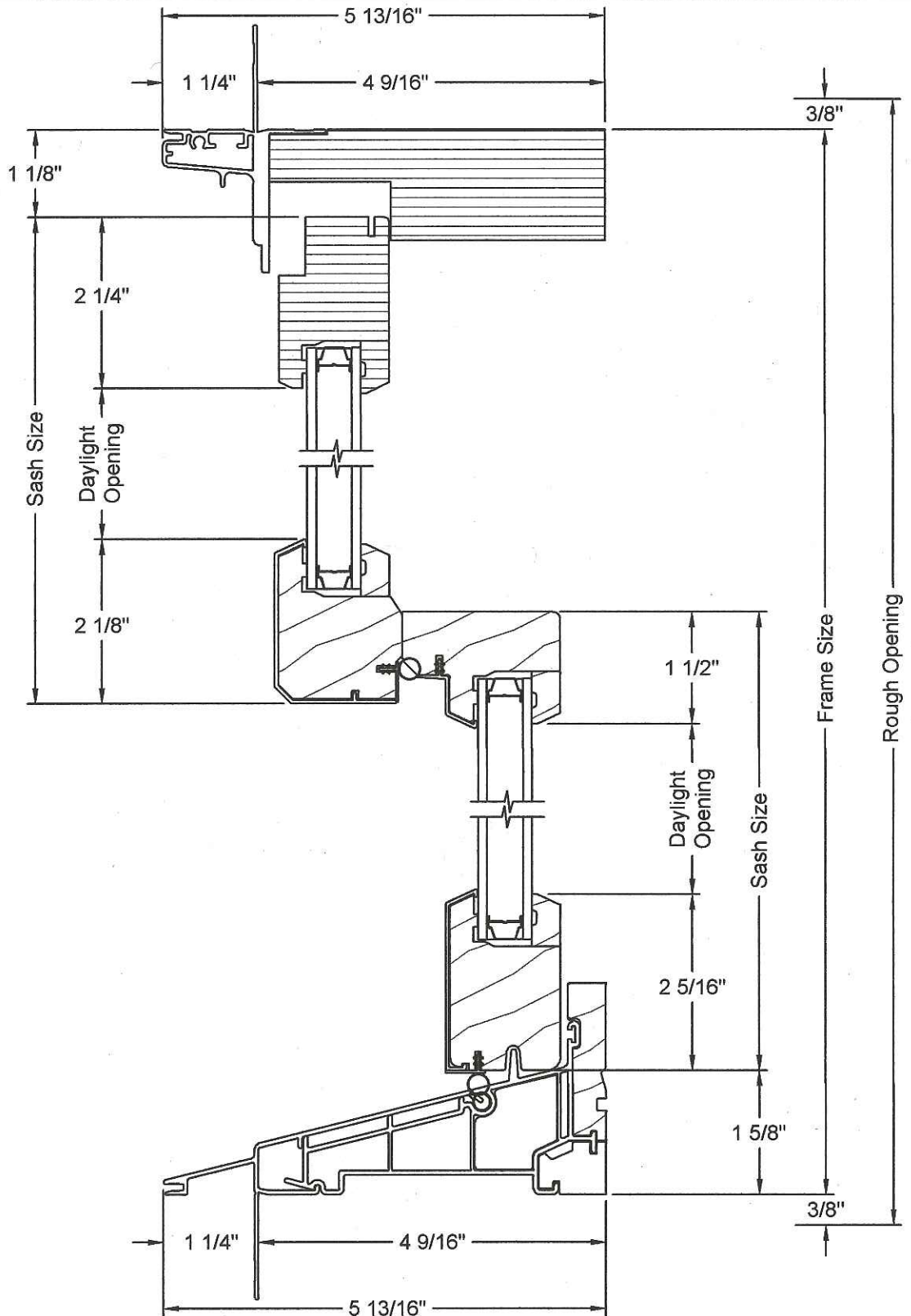



SEGMENT HEAD - VERTICAL SECTION

