

JELD-WEN
WINDOWS & DOORS

Custom
Wood Window & Patio Door Features

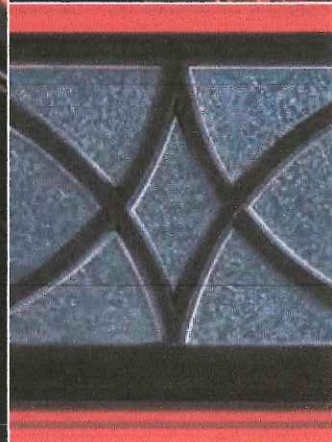

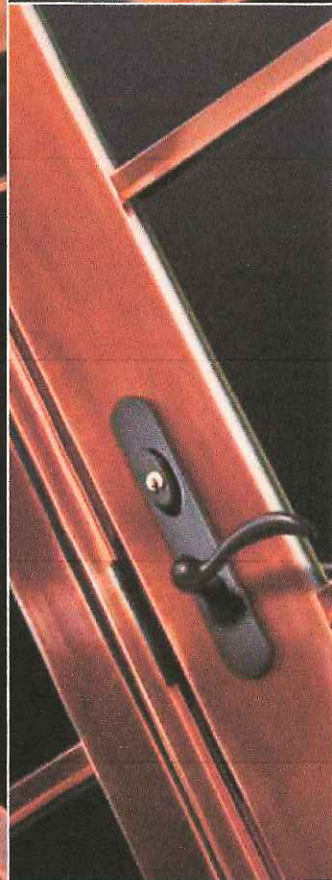
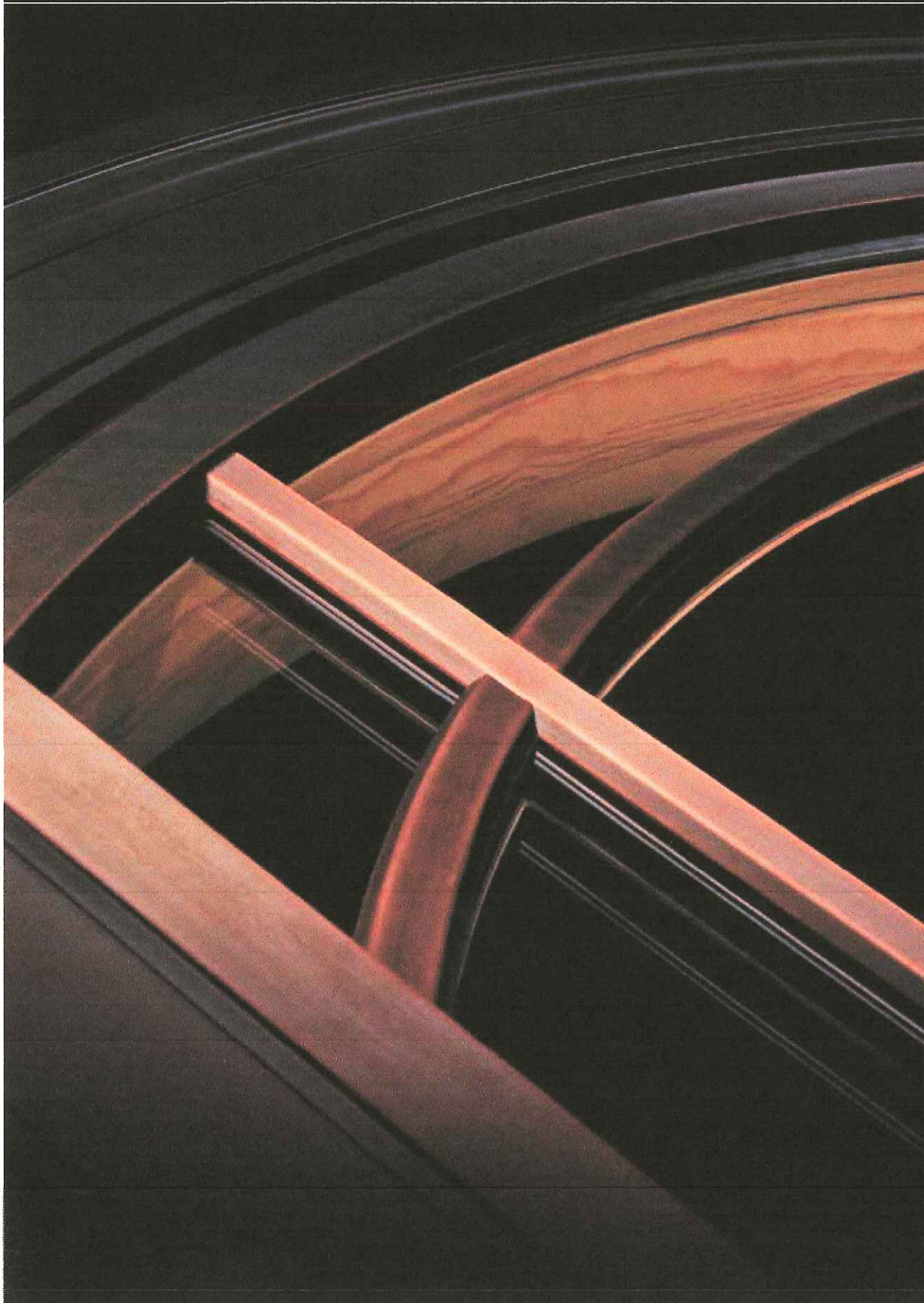

AuraLast® wood protects against wood rot for as long as you own and occupy your home. Guaranteed.*

A JELD-WEN Exclusive - Only JELD-WEN makes window and door products with natural pine AuraLast wood that are built to last.

Surface-to-Core Protection - AuraLast wood delivers virtually 100% surface-to-core penetration of the protective ingredients.

Protects Against Wood Decay - AuraLast wood prevents damage and rot due to weather conditions, water saturation or termites.

Working with AuraLast Wood is Easy - AuraLast wood maintains its structural integrity despite what it's put through; it is colorless, stainable and odorless.

JELD-WEN® products made from pine AuraLast wood will not rot.

Virtually 100% Surface-to-Core Protection



LIFETIME LIMITED WARRANTY

**AuraLast Lifetime Limited Warranty Coverage for Wood Decay and Termite Damage*

Visit jeld-wen.com/auralast for more information

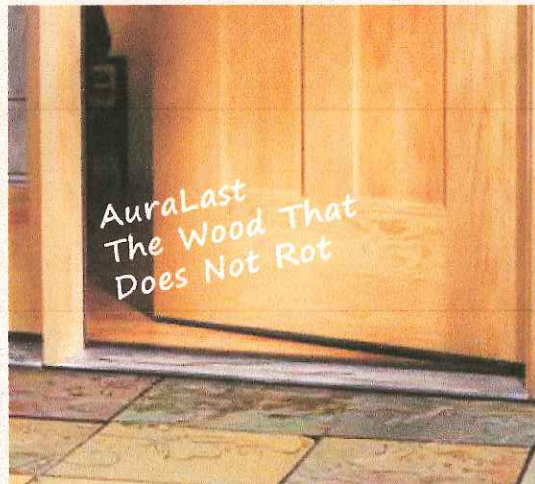

IMPACT RESISTANT GLASS

www.jeld-wen.com/impactgard

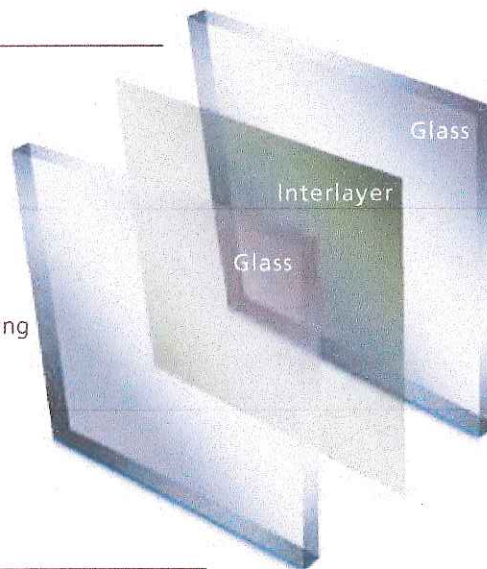

This glass stands up to strong impacts from wind-borne debris as well as harsh coastal conditions. In fact, ImpactGard® glass features the industry's leading laminated glass technology that can withstand a nine-pound piece of lumber striking it head-on at approximately 34 miles per hour. It also reduces sound transmission, blocks up to 95 percent of harmful UV rays and enhances home security.

SAFE



Impact resistance to wind-borne debris

SECURE



Forced-entry resistance for increased safety

SOUND



Decreased sound transmission

WOOD & METAL CLAD OPTIONS

Our Custom wood windows and patio doors are built from solid pine AuraLast® wood for lasting beauty, and each one comes standard with energy efficient LoE³-366 and Neat® glass. These windows and patio doors are also available with the greatest array of design options. To review our full range of styles and options, visit www.jeld-wen.com.

STANDARD INTERIOR FINISHES

1. Brilliant White
2. Ivory
3. Desert Sand
4. Clear Lacquer
5. Wheat
6. Cider
7. Fruitwood
8. Cordovan
9. Walnut



Colors shown may not match final finish.

Custom paint and stain options available.



FSC® or SFI® certified wood available.

INTERIOR & EXTERIOR OPTIONS FOR WINDOWS & PATIO DOORS

Interior: **I**

Exterior: **E**

<p>Primed I</p>  <p>AuraLast® Pine I E</p>	<p>Cherry I</p>  <p>Knotty Alder I</p>	<p>Oak I</p>  <p>Vertical-Grain Douglas Fir I E</p>	<p>Walnut I</p>  <p>Mahogany I E</p>	<p>Custom Species I</p>  <p>Reclaimed Douglas Fir I</p>
--	--	---	--	---

42 EXTERIOR CLAD COLORS

Custom color match available



Actual colors may vary from the samples displayed.
Please visit your JELD-WEN dealer for actual samples.

SELECT FINISH

Choose to paint the exterior of the window instead of applying metal cladding.

3 EXTERIOR COPPER CLAD FINISHES

 <p>Bright Copper</p>	 <p>Speckled Patina Copper</p>	 <p>Hand-Rubbed Patina Copper</p>
---	---	--

Windows and patio doors installed within one mile of a saltwater source (or other corrosive environment) have specific maintenance requirements.

For details visit: www.jeld-wen.com/resources

TRIM & DIVIDED LITES

INTERIOR TRIM



WM316

WM346

WM356

WM366

WM445

EXTERIOR TRIM

(Additional interior and exterior trim options may be available. See your JELD-WEN dealer for details.)



Adams

Brickmould

Flat (3-1/2",
4-1/2", 5-1/2")

Pendleton

Backband

Heritage

Adams

Brickmould

Flat

Manchester

Pendleton

DIVIDED LITES

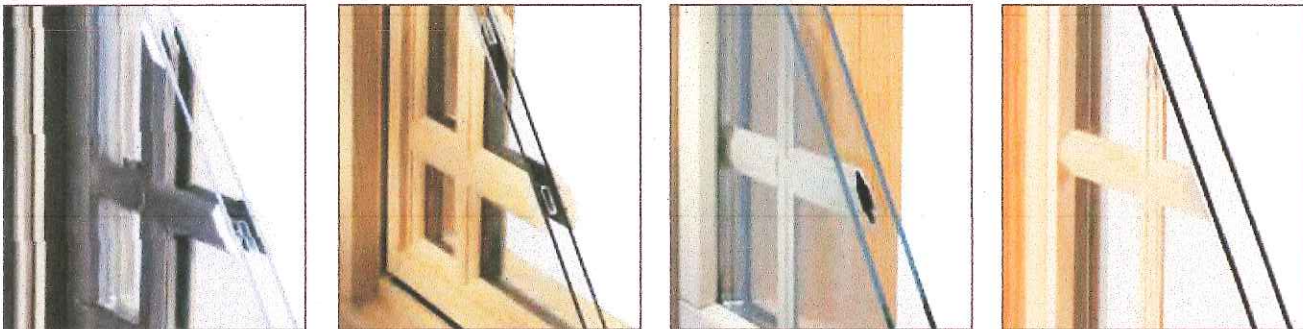

Simulated Divided Lites (SDL)

Precise Divided Lites (PDL)*

Grilles Between the Glass (GBG)

Full-Surround Wood Grilles (FS)

*Wood exterior only

**Available in all sizes shown

SAMPLING OF OUR SIMULATED DIVIDED LITE PROFILES

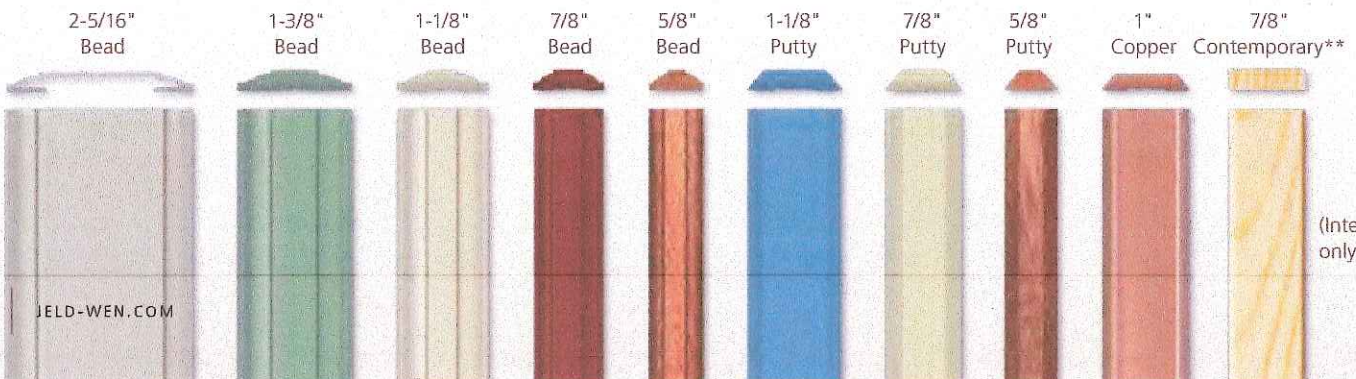

2-5/16" Bead

1-3/8" Bead

1-1/8" Bead

7/8" Bead

5/8" Bead

1-1/8" Putty

7/8" Putty

5/8" Putty

1" Copper

7/8" Contemporary**

(Interior only)

TINTED, TEXTURED GLASS & SCREENS

SAMPLING OF OUR TEXTURED AND TINTED GLASS OPTIONS

(Many other glass options available. See your JELD-WEN dealer for details.)



WINDOW OPENING CONTROL DEVICE

Optional: Opening Control Device limits sash opening to 3-3/4 inches for fall prevention.

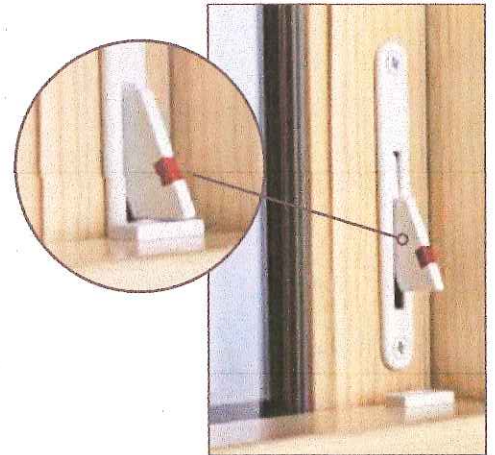

PHANTOM SCREENS® TECHNOLOGY

Available to match interior wood species



Insect screens are intended to allow air and light in, while keeping insects out. They are not intended to stop children from falling through an open door or window. For additional protection, consider adding a Window Opening Control Device (WOCD) to the window.

*Screens available in all species shown on page 3 with the exception of Reclaimed Fir

ULTRAVUE™ SCREENS

These screens are designed to keep more insects outside, while letting more natural light inside.

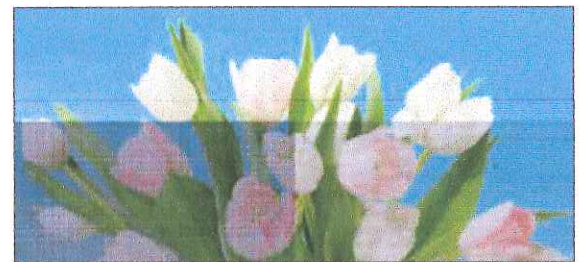

View through regular fiberglass insect screen

View through UltraVue® insect screen (standard)

Please note: These images are for illustration purposes only. Actual screen may appear different.

WOOD SELECTION FOR CASEMENT AND AWNING WINDOW SCREENS*

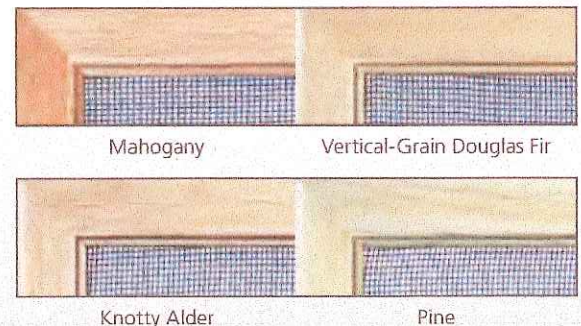

Mahogany

Vertical-Grain Douglas Fir

Knotty Alder

Pine

DECORATIVE GLASS

Featuring five popular standard glass collections, this program allows you to design endless decorative glass creations. Using combinations of patterns, colors, obscure glass and coming options, we can build nearly anything you can imagine.

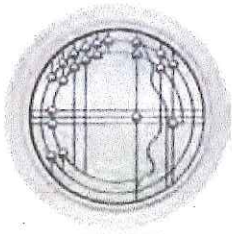

CONTEMPORARY COLLECTION

Modern and bold with a unique look certain to add style to modern-day homes.

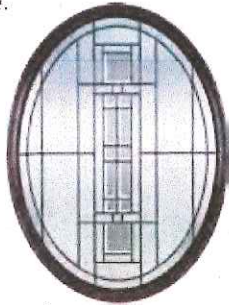

ESTATE COLLECTION

Fits many types of architecture and has straight bold lines adding to the decor of any home.



CLASSIC COLLECTION

This elegant collection adds a distinct and timeless design element to any home.

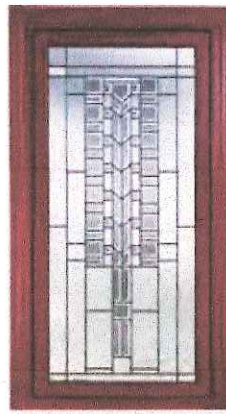

CRAFTSMAN COLLECTION

A tried and true design that represents a theme that has stood the test of time.



DIAMOND COLLECTION

A classic Tudor style that evokes an old world charm.

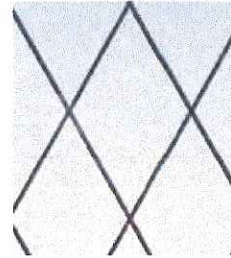

CAMING SELECTIONS

Choose one of our five coming selections to determine how ornate, elegant or plain your decorative glass will appear.



Satin Nickel



Copper



Dark Patina



Brass



Zinc

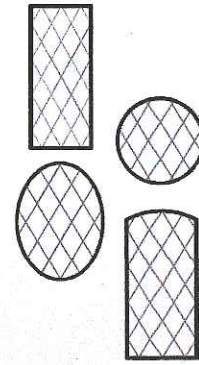
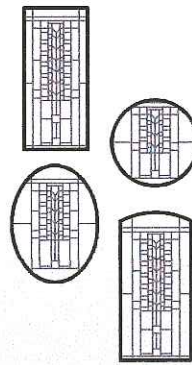
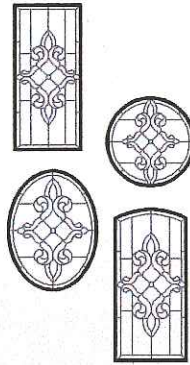
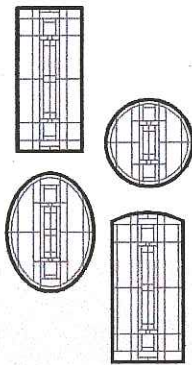
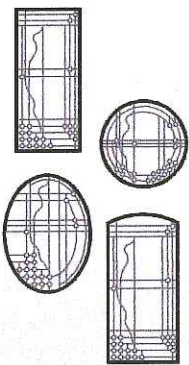

DECORATIVE GRILLES & HARDWARE

DECORATIVE GRILLES BETWEEN THE GLASS

The JELD-WEN® Decorative Grille Program features custom capabilities to build your own creations. Using your sketches and combinations of patterns, we can build nearly anything you imagine.

Some of our most popular designs are shown below.

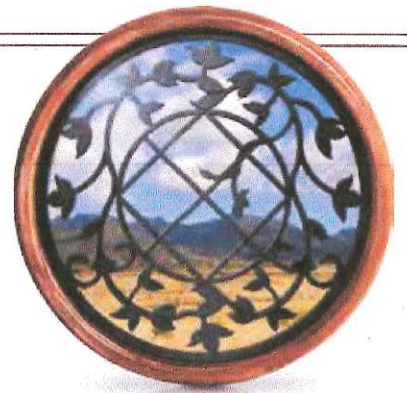

RADIUS TOP

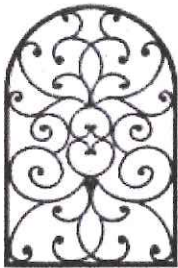

Versailles™

RECTANGLE



Versailles™

FULL CIRCLE

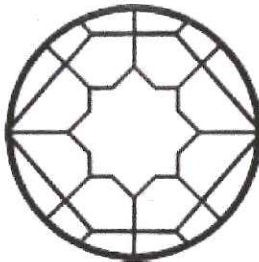

Etruscan™

SEGMENT TOP

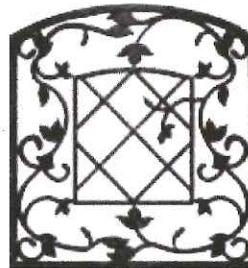

Chateau™

SQUARE

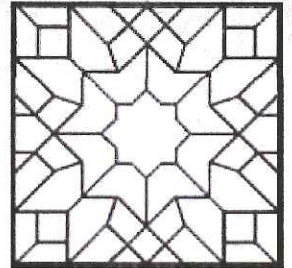

Etruscan™



Georgian™

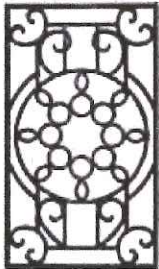

Sundial™



Chateau™



Infinity™



Infinity™

HARDWARE OPTIONS

Swinging Patio Door

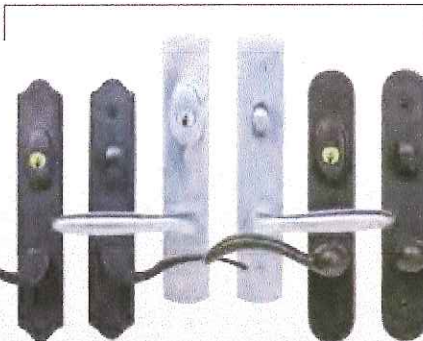

Traditional

Contemporary

Rustic

Sliding Patio Door

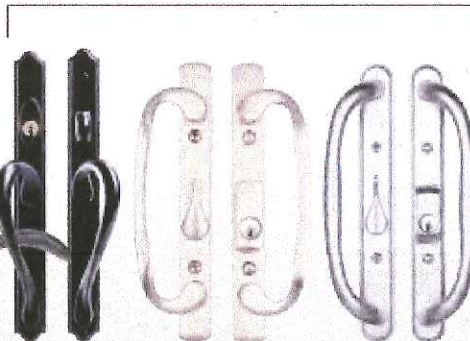

Multi-Point

Dual-Point

Dual-Point

Windows

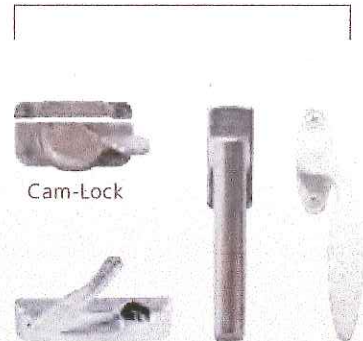

Cam-Lock

Nesting Handle

Tilt & Turn

Push Out Handle

ELEVATION NOTES

Door Size = Book Size Before Prefit
 Daylight Opening (DLO) = Visible Glass
 Values in brackets [] are millimeter conversions.

DOOR CROSS-SECTION

Moulding Profile = 141 / Ovolo
 Panel Profile = 45 Degree
 See 444 Cross Section sheet for more detail.

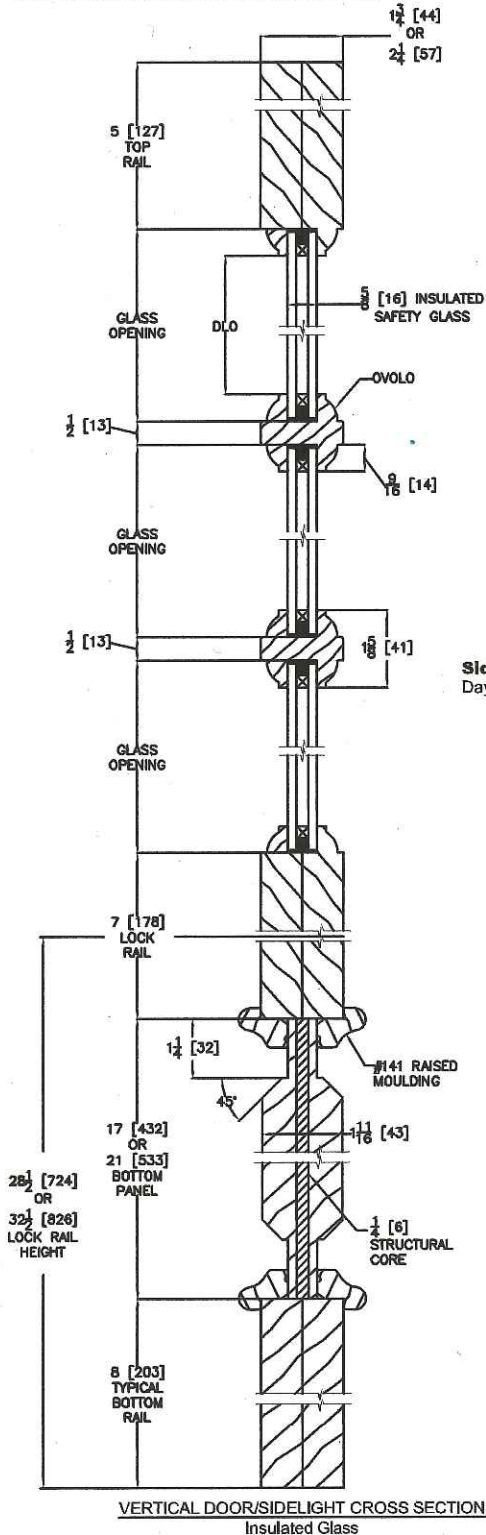

Door Size
 Daylight Opening

30" [762]
 5 7/32" [133]

32" [813]
 5 7/8" [149]

36" [914]
 7 7/32" [183]

42" [1067]
 9 7/32" [234]

80" [2032]
 12 7/8" [327]

84" [2134]
 12 7/8" [327]

96" [2438]
 16 7/8" [429]

Sidelight Size
 Daylight Opening

12" [305]
 7 7/8" [200]

13" [330]
 7 7/8" [200]

14" [356]
 7 7/8" [200]

15" [381]
 9 7/8" [251]

16" [406]
 9 7/8" [251]

17" [432]
 9 7/8" [251]

18" [457]
 9 7/8" [251]

80" [2032]
 12 7/8" [327]

84" [2134]
 12 7/8" [327]

96" [2438]
 16 7/8" [429]

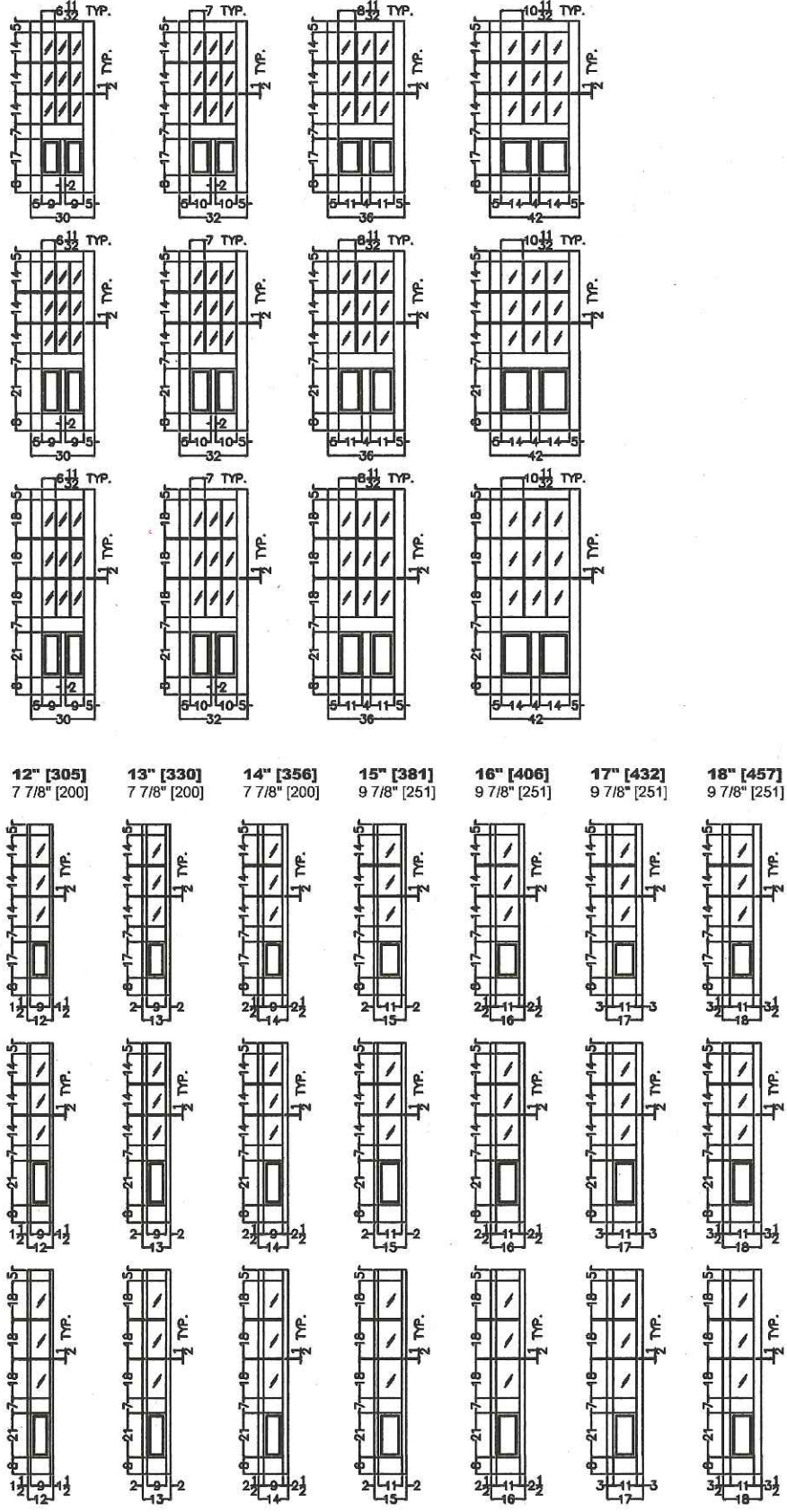

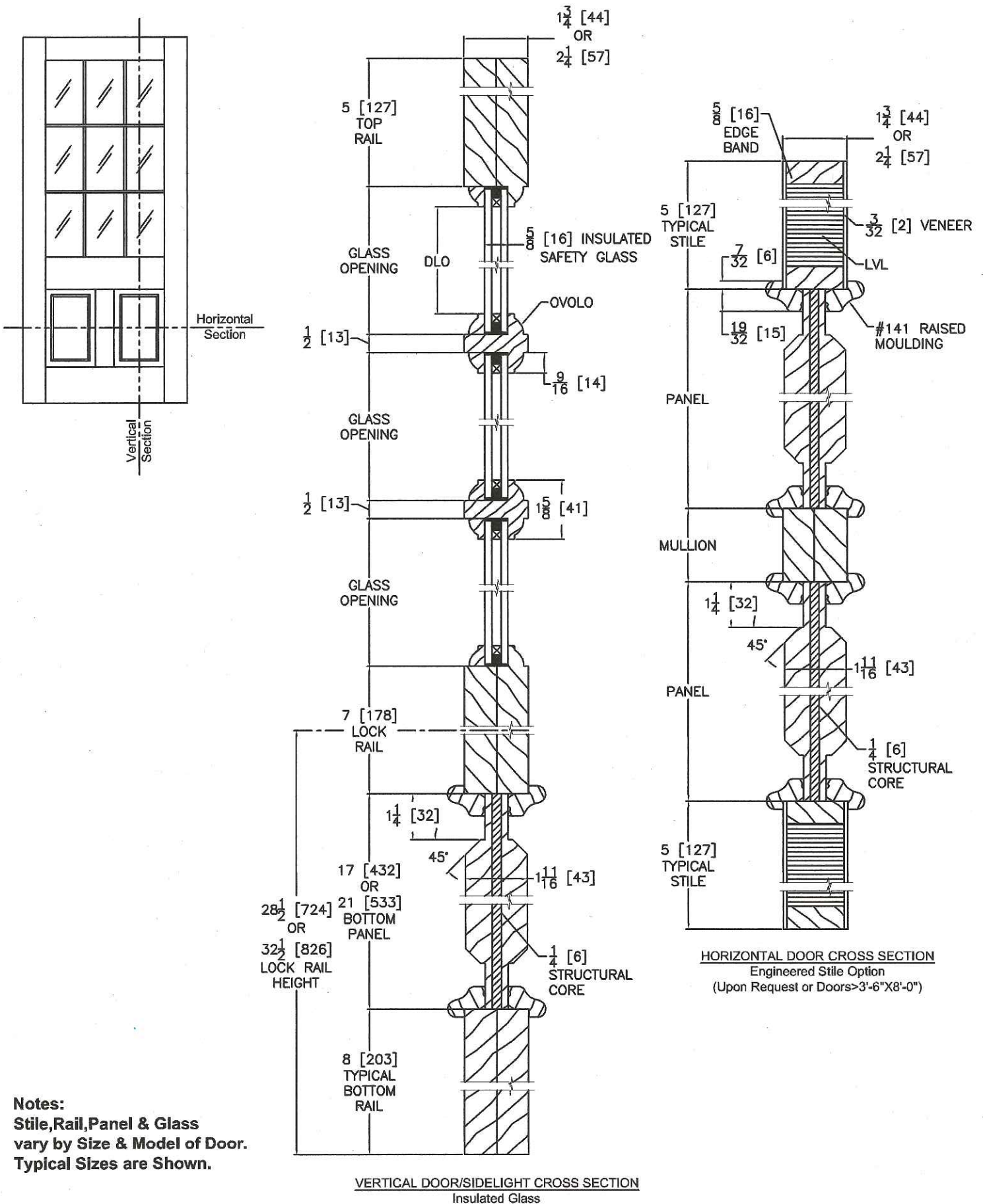

Notes:
Stile, Rail, Panel & Glass
vary by Size & Model of Door.
Typical Sizes are Shown.