



DISPLAY THIS CARD ON PRINCIPAL FRONTAGE OF WORK

CITY OF PORTLAND



BUILDING

PERMIT

PERMIT ISSUED  
JAN 24 2011  
CITY OF PORTLAND

This is to certify that & M PARTNERS INC A

Located At 400 CONGRESS

Job ID: 2011-01-256-FAFS

CBL: 032 - - G - 001 - - - -

has permission to Install Fire Alarm 4th flr "Kepware"

provided that the person or persons, firm or corporation accepting this permit shall comply with all of the provisions of the Statues of Maine and of the Ordinances of the City of Portland regulating the construction, maintenance and use of the buildings and structures, and of the application on file in the department.

Notification of inspection and written permission procured before this building or part thereof is lathed or otherwise closed-in. 48 HOUR NOTICE IS REQUIRED.

A final inspection must be completed by owner before this building or part thereof is occupied. If a certificate of occupancy is required, it must be procured prior to occupancy.

Fire Prevention Officer

Code Enforcement Officer / Plan Reviewer

THIS CARD MUST BE POSTED ON THE STREET SIDE OF THE PROPERTY.  
PENALTY FOR REMOVING THIS CAR

SCANNED



# Fire Alarm Permit

If you or the property owner owes real estate or property taxes or user charges on any property within the city, payment arrangements must be made before permits of any kind are accepted.

Installation address: 400 Congress St. CBL: 32 G 1

Exact location: (within structure) 4th floor renovations (Kepware)

Type of occupancy(s) (NFPA & ICC): business

Building owner: A&M Partners

System Designer (point of contact): David Gagnon--Norris Inc.

Designer phone: 207-883-3473 x1115 E-mail: daveg@norrisinc.com

Installing contractor: Norris Inc. Certificate of Fitness No: 1008

Contractor phone: 207-883-3473 x1104 E-mail: melissap@norrisinc.com

This is a new application: YES  NO  New AES Master Box: YES  NO   
(Include Master Box approval form)

Amendment to an existing permit: YES  NO  Permit no: \_\_\_\_\_

The following documents shall be provided with this application:

- Floor plans
- Wiring diagram
- Annunciator details *NA*
- Input/ Output Matrix
- Equipment data sheets
- Electrical Permit Pulled (check alarm/com) *by owner*
- Scope of Work
- 11 1/2 x 17s
- pdf copy (may be e-mailed)
- Designer qualifications
- Battery/ voltage drop calcs

Master box approval only: YES  NO   
(If yes check *New AES Master Box* above)

COST OF WORK: 2000.00

PERMIT FEE: \$42.00  
(\$10 PER \$1,000 + \$30 FOR THE FIRST \$1,000)

RECEIVED

JAN 13 2011

The designer shall be the responsible party for this application. Download a new copy of this application at [www.portlandmaine.gov/fire](http://www.portlandmaine.gov/fire) for every submittal. Submit all plans in electronic PDF in addition to readable 11 1/2 x 17s to the Building Inspections Department, 389 Congress Street, Room 315, Portland, Maine 04101.

Prior to acceptance of any fire alarm system, a complete commissioning and acceptance test must be coordinated with all fire system contractors and the Fire Department, and proper documentation of such test(s) provided.

All installation(s) must comply with the *City of Portland Technical Standard for Signaling Systems for the Protection of Life and Property*, available at [www.portlandmaine.gov/fire](http://www.portlandmaine.gov/fire).

Applicant signature: Melissa Peters Date: 1/13/11



PO Box 2551  
2257 West Broadway  
South Portland, ME 04106

1.800.370.3473  
fax 207.879.0540

[www.norrisinc.com](http://www.norrisinc.com)

Scope of Work—400 Congress St. Portland, ME.

The 4<sup>th</sup> floor of the building is currently being renovated for a new tenant, Kepware. Norris Inc. will add notification devices as shown on the attached plans. Norris Inc. will also install a monitor module to monitor a suppression system to be installed by others. 1 existing pull station at the rear exit will be reused. Norris Inc. will also add a smoke detector over the fire alarm control panel on the first floor per code. All new devices will be tested through to the central station and the Portland Fire Dept.

Job No: 2011-01-256-FAFS	Date Applied: 1/14/2011	CBL: 032 - - G - 001 - 001 - - - - -	<div style="border: 1px solid black; padding: 5px; text-align: center;">                 PERMIT ISSUED                  JAN 24 2011                  CITY OF PORTLAND             </div>	
Location of Construction: 400 CONGRESS	Owner Name: & M PARTNERS INC A	Owner Address: 120 EXCHANGE ST PORTLAND, ME - MAINE 04103		
Business Name:	Contractor Name: Peters, Melissa	Contractor Address:	Phone:	
Lessee/Buyer's Name:	Phone:	Permit Type: FIRE ALARM - Fire Alarm	Zone: B-3	
Past Use:  Offices & Business Service	Proposed Use:  Same - Offices & Business	Cost of Work: 2000.000000	CEO District:	
		Fire Dept: <input checked="" type="checkbox"/> Approved w/ conditions <input type="checkbox"/> Denied <input type="checkbox"/> N/A	Inspection: Use Group: Type: Signature: <i>[Signature]</i>	
Proposed Project Description: 400 Congress St - Kepware - 4th floor #101225 - FIRE ALARM		Pedestrian Activities District (P.A.D.)		

Permit Taken By:  1. This permit application does not preclude the Applicant(s) from meeting applicable State and Federal Rules. 2. Building Permits do not include plumbing, septic or electrical work. 3. Building permits are void if work is not started within six (6) months of the date of issuance. False informatin may invalidate a building permit and stop all work.	<b>Zoning Approval</b>		
	<b>Special Zone or Reviews</b> <input type="checkbox"/> Shoreland <input type="checkbox"/> Wetlands <input type="checkbox"/> Flood Zone <input type="checkbox"/> Subdivision <input type="checkbox"/> Site Plan Date: <i>[Signature]</i> 1/14/11	<b>Zoning Appeal</b> <input type="checkbox"/> Variance <input type="checkbox"/> Miscellaneous <input type="checkbox"/> Conditional Use <input type="checkbox"/> Interpretation <input type="checkbox"/> Approved <input type="checkbox"/> Denied Date:	<b>Historic Preservation</b> <i>w/ h/m</i> <input type="checkbox"/> Not in Dist or Landmark <input type="checkbox"/> Does not Require Review <input type="checkbox"/> Requires Review <input type="checkbox"/> Approved <input type="checkbox"/> Approved w/Conditions <input type="checkbox"/> Denied Date: <i>[Signature]</i> requires a separate review & approvals

I hereby certify that I am the owner of record of the named property, or that the proposed work is authorized by the owner of record and that I have been authorized by the owner to make this application as his authorized agent and I agree to conform to all applicable laws of this jurisdiction. In addition, if a permit for work described in the application is issued, I certify that the code official's authorized representative shall have the authority to enter all areas covered by such permit at any reasonable hour to enforce the provision of the code(s) applicable to such permit.

SIGNATURE OF APPLICANT	ADDRESS	DATE	PHONE
------------------------	---------	------	-------

RESPONSIBLE PERSON IN CHARGE OF WORK, TITLE	DATE	PHON
---	------	------

**Job Summary Report**  
**Job ID: 2011-01-256-FAFS**

**Job Type:** Fire Alarm / Suppression  
**Job Description:** 400 Congress St - Kepware - 4th floor #101225  
**Job Year:** 2011  
**Building Job Status Code:** Initiate Plan Review  
**Pin Value:** 441  
**Tenant Name:**  
**Job Application Date:** Public Building Flag: N  
**Square Footage:** 2,000  
**Related Parties:** & M PARTNERS A  
 Property Owner  
 Norris Inc - Melissa Peters  
 GENERAL CONTRACTOR

**Job Charges**

Fee Code Description	Charge Amount	Permit Charge Adjustment	Net Charge Amount	Payment Date	Receipt Number	Payment Amount	Payment Adjustment Amount	Net Payment Amount	Outstanding Balance
Job Valuation Fees	\$40.00		\$40.00						\$40.00

**Location ID: 4712**

Location Details									
Alternate Id	Parcel Number	Census Tract	GIS X	GIS Y	GIS Z	GIS Reference	Longitude	Latitude	
A00470	032 G 001 001	M					-70.257013	43.65846	
Location Type							Subdivision Code	Subdivision Sub Code	Related Persons
							1	400 CONGRESS STREET WEST	

Location Use Code	Variance Code	Use Zone Code	Fire Zone Code	Inside Outside Code	District Code	General Location Code	Inspection Area Code	Jurisdiction Code
OFFICE & BUSINESS SERVICE		NOT APPLICABLE			Historic District		DISTRICT 2	CENTRAL BUSINESS DISTRICT

**Structure: Loc id 000004711 Alt id 001201**

**Occupancy Type Code:**

Structure Type Code	Structure Status Type	Square Footage	Estimated Value	Address	
CONVERSION	6	56889.36		400 CONGRESS STREET WEST	
Longitude	Latitude	GIS X	GIS Y	GIS Z	GIS Reference
0	0	M			

**Structure: Loc id 000050490 Alt id A00170**

User Defined Property Value





PO Box 2551  
2257 West Broadway  
South Portland, ME 04106

1.800.370.3473  
fax 207.879.0540

[www.norrisinc.com](http://www.norrisinc.com)

# ***SUBMITTAL PACKAGE***

**Project:** 400 Congress St. 4th Floor Fit Up

**System:** Fire Alarm

**Submitted** Norris Inc.

**By:** 2257 West Broadway  
South Portland, Maine 04106  
Telephone: (800) 370-3473

**Project  
Manager:** Corey Chapman

**Date:** 1/12/11



PO Box 2551  
2257 West Broadway  
South Portland, ME 04106

1.800.370.3473  
fax 207.879.0540

[www.norrisinc.com](http://www.norrisinc.com)

## Company Profile

*"We are extremely proud to represent the highest quality manufacturers integrating life safety, alarm and communication systems throughout northern New England."*

*-- Bradford Norris, President --*

## Mission Statement

Provide quality engineered systems, exceptional service.

## Goal

Learn...Continually Improve...Exceed Expectations

Founded in 1979 Norris Inc. has grown to become Northern New England's leading integrated system contracting and supply company. Norris Inc. is an innovated proactive organization with extensive experience in integration interdisciplinary building management systems. Our local and national affiliations assure that your project will be done properly regardless of size representing leading manufacturers our comprehensive products provide outstanding quality reliability and performance... surpassing customer application requirements and exceeding the stringent requirements of Underwriters Laboratories, National Fire Protection Association and other codes. We maintain an exceptional level of quality and provide the highest levels of customer service. Our knowledgeable technical support will insure the great service you deserve. Whether your needs involve industrial, commercial, institutional, or educational applications, you can trust that Norris Inc. has the complete resources it takes to provide the right solution right away.

---



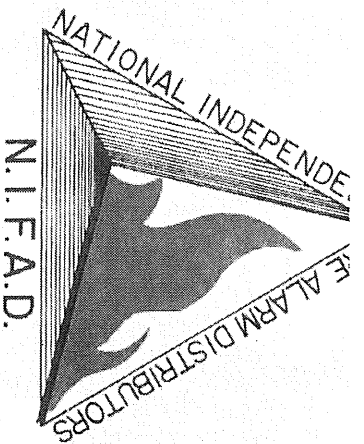

# National Independent Fire Alarm Distributors Association

This is to Certify that

Morris Inc.

is a

Member in Good Standing

and is entitled to all rights and privileges of such membership

David Parker

Secretary

Bob Smith

President

**NBFAA**

Electronic Life Safety, Security  
& Systems Professionals

# National Burglar & Fire Alarm Association Norris Inc

*is a member in good standing entitled to all rights  
& privileges of membership and subject to all conditions  
& objectives as defined in the association bylaws.*



**Merlin J. Guilbeau**  
Executive Director



**Michael A. Miller**  
President

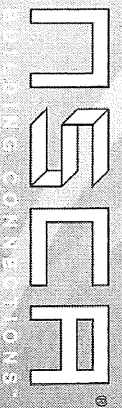

2009

NATIONAL SYSTEMS CONTRACTORS ASSOCIATION

# NSCA Membership Certificate

This is to certify that

**Norris Inc**

is an official member of the  
**National Systems Contractors Association**

on this the

*First of December*

*Andrew M. Musci*

**Andrew M. Musci**  
President

*Chuck R. Wilson*

**Chuck Wilson**  
Executive Director

# Certificate of Membership

## AFAA

This is to Certify that  
*Norris, Inc.*

Has been duly elected to membership in this organization through  
*May 31, 1999*

and pledged to improve LIFE SAFETY IN AMERICA by striving to ensure  
fire protective signaling and automatic detection systems are properly designed, installed and maintained.

*James M. Jandy Jr.*  
CHAIRMAN OF THE BOARD

*David B. Bink*  
SECRETARY

**AUTOMATIC FIRE ALARM ASSOCIATION, INC.**  
a non-profit organization



PO Box 2551  
2257 West Broadway  
South Portland, ME 04106

1.800.370.3473  
fax 207.879.0540

www.norrisinc.com

Please fax this information to the Administrative Sales Assistant at the So. Portland Office at (207)-879-0540.

## Building Owner Information Form

Job Name:	Project #:
Electrical Contractor:	

# NFPA requires this information for proper documentation

***\*The contractor MUST provide all of the information with an asterisk below before ANY equipment can be released.***

*If building owner contact is unknown provide contact name/tel. of GC and check box*

Electrical Contractor Contact Name:	
Estimated Date Equip. Needed:	*Estimated Finals Date:

*Building Owner:
------------------

*Job Site Address:
--------------------

*City:	State:	Zip:
--------	--------	------

*Contact Name:	Check here if GC
----------------	------------------

*Phone #:	Fax #:
-----------	--------



PO Box 2551  
2257 West Broadway  
South Portland, ME 04106

1.800.370.3473  
fax 207.879.0540

[www.norrisinc.com](http://www.norrisinc.com)

**Thank you for your cooperation.**

**Please advise the building owners that if this system is equipped with a digital communicator, then they MUST also make monitoring arrangements prior to a certificate of occupancy. Norris Inc. will attempt to contact the building owners**

---

# **STOP!**

**THIS COPY IS FOR YOUR ELECTRICIAN  
ON THE JOB-SITE**

**PLEASE BE SURE THIS COPY IS FORWARDED**

- 1) A riser diagram is enclosed. **DO NOT USE THE ENGINEER'S RISER SHOWN ON THE PLANS.** If there is any information that you question, call us immediately.
- 2) **YOU MUST CALL AT LEAST FIVE DAYS IN ADVANCE TO SCHEDULE FINAL CONNECTION ASSISTANCE.**
- 3) All of your wires must be labeled and clear of any grounds, shorts or opens and must maintain polarity throughout. Meter out all circuits before calling for final connection assistance. If applicable verify End of Line resistors are in place.
- 4) If using shielded cable, the drain wires must be connected and fully insulated (wrapped with tape) so that neither the shield or the drain wire touches the backbox.
- 5) Unless special arrangements are made, we will make one final job-site visit. If a special visit is required for an elevator inspection or partial occupancy, then additional charges may apply if special arrangements were not made ahead. Call your customer service representative.
- 6) If you have any defective or left-over parts **DO NOT WRITE ON THEM OR THE BOXES.** Save the original box, all mounting hardware and instructions. Returns that do not conform to this practice will not be accepted for credit.
- 7) If the system is being monitored through a digital communicator, then please turn to page 2.



PO Box 2551  
2257 West Broadway  
South Portland, ME 04106

1.800.370.3473  
fax 207.879.0540

[www.norrisinc.com](http://www.norrisinc.com)

## **IMPORTANT INFORMATION FOR THE BUILDING OWNERS**

### **SPECIAL NOTE REGARDING ALARM MONITORING SERVICES**

Included within your alarm system package is a digital communicator, which sends a coded message to a private 24-hour central station if your alarm system is activated. This is a code requirement for most fire alarm systems. As a service to our customers, we offer central station monitoring services from our local UL Listed central station at extremely competitive rates.

If the central station monitoring contract is purchased through Norris Inc. prior to our scheduled start-up; we will connect, program, and test the communicator at no additional charge.

Should the building owners decide to obtain monitoring services from another company, then the costs for programming and testing the communicator will be the sole responsibility of the firm they have contracted with. Furthermore, if programming changes are made to the system by persons other than Norris Inc. technicians, then the company performing the changes shall be solely liable for any personal injury or loss of life or damage to or loss of property arising out of the use of or inability to use the system and it shall result in a waiver of any system warranties.

We appreciate that you understand the delicate nature of this life safety and/or security system and realize that serious problems may arise when modifications to the system are made including very simple programming changes.

**Call Norris Inc. at 1-888-312-FIRE (3473) to make  
arrangements for central station monitoring services.**



This  
Certificate of Fitness  
for

**Fire Alarm Installation and Servicing Company**

is awarded to



**Norris Incorporated**  
PO Box 2551 - 2257 West Broadway  
South Portland, ME 04106  
(207)883-3473

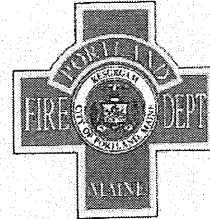

CF # 1008

12/31/2010

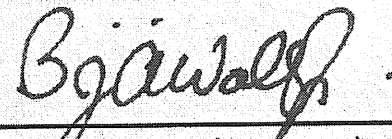
  
\_\_\_\_\_  
Authority Having Jurisdiction

\_\_\_\_\_  
Expiration Date

THIS CERTIFICATE IS NOT AN ENDORSEMENT OF THIS COMPANY BY THE  
AUTHORITY HAVING JURISDICTION.

TERMS AND CONDITIONS OF THIS CERTIFICATE OF FITNESS SHALL BE AS  
FOLLOWS:

THIS CERTIFICATE REMAINS THE PROPERTY OF THE PORTLAND FIRE  
DEPARTMENT AND SHALL BE RETURNED UPON DEMAND;

THIS CERTIFICATE OF FITNESS IS NON-TRANSFERABLE;

THIS CERTIFICATE OF FITNESS SHALL REMAIN IN EFFECT IN SO FAR AS THE  
BEARER OF SAID INSTRUMENT SHALL COMPLY WITH RULES AND  
REGULATIONS ESTABLISHED BY THE AUTHORITY HAVING JURISDICTION.

FAILURE TO COMPLY WITH ALL RULES AND REGULATIONS OF THE  
AUTHORITY HAVING JURISDICTION WILL RESULT IN THE FOLLOWING:

FIRST OFFENCE: PLAN OF ACTION TO ADDRESS DEFICIENCIES

SECOND OFFENCE: PROBATION OF SERVICE COMPANY

THIRD OFFENCE: TERMINATION OF CERTIFICATE OF FITNESS



Norris Inc  
 2257 West Broadway  
 South Portland, ME 04106  
 1-800-370-3473

\*\* SUBMITTAL \*\* 1/12/2011  
 Project Number: 308993SP

For :
400 Congress St. 4th Floor Fit Up Customer P.O.: X

** SUBMITTAL ** to:
A & M PARTNERS INC ATTN: ACCOUNTS PAYABLE 120 EXCHANGE ST PORTLAND, ME 04101
Tel: 207-879-1358      Fax: 874-6988

Project Site:
Stefan Scarks  400 Congress St Portland, ME 04101

Mfr-Part No.	Qty Description	Unit Price	Extended
NOTIFIER-SD355	1 Addressable Smoke Detector with base		
NOTIFIER-HSR	5 Horn Strobe, Wall, Red		
NOTIFIER-STR	5 Strobe, Wall, Red		
ADI-FL-MMF300	1 Addressable Monitor Module (suppression system)		

# SD355(A), SD355T(A), SD355R(A)

## Addressable Photoelectric Smoke Detectors

df-52384:b • E-160



### Addressable Devices

#### General

The SD355(A) and SD355T(A) addressable, low-profile plug-in photoelectric detectors use a state-of-the-art photoelectric sensing chamber with communications to provide open area protection and are used exclusively with Fire•Lite's Addressable Fire Alarm Control Panels (FACPs). The SD355T(A) adds thermal sensors that will alarm at a fixed temperature of 135°F (57°C). Since these detectors are addressable, they will help emergency personnel quickly locate a fire during its early stages, potentially saving precious rescue time while also reducing property damage. Two LEDs on each sensor light to provide a local, visible sensor indication. Remote LED annunciator capability is available as an optional accessory (P/N RA100Z(A)). The SD355R is a remote test capable detector for use with D355PL or DNR(W) duct smoke detector housings.

#### Features

##### SLC loop:

- Two-wire loop connection.
- Unit uses base for wiring.

##### Addressing:

- Addressable by device.
- Direct Decade entry of address: 01 – 99 with MS-9200 series, and 01 – 159 with MS-9600 series.

##### Architecture:

- Unique single-source, dual-chamber design to respond quickly and dependably to a broad range of fires.
- Sleek, low-profile design.
- Integral communications and built-in type identification.
- Built-in tamper-resistant feature.
- Removable cover and insect-resistant screen for simple field cleaning.

##### Operation:

- Withstands air velocities up to 4,000 feet-per-minute (20 m/sec.) without triggering a false alarm.
- Factory preset at 1.5% nominal sensitivity for panel alarm threshold level.
- Visible LED "blinks" when the unit is addressed (communicating with the fire panel) and latches on in alarm.

##### Mechanicals:

- Sealed against back pressure.
- Direct surface mounting or electrical box mounting.
- Mounts to: single-gang box, 3.5" (8.89 cm) or 4.0" (10.16 cm) octagonal box, or 4.0" (10.16 cm) square electrical box (using a plaster ring — included).

##### Other system features:

- Fully coated circuit boards and superior RF/transient protection.
- 94-V0 plastic flammability rating.
- Low standby current.

##### Options:

- Remote LED output connection (P/N RA100Z).



SD355 with B350LP base

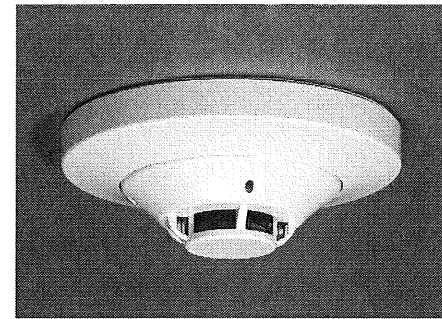

SD355T with B350LP base

#### Applications

Use photoelectric detectors in life-safety applications to provide a broad range of fire-sensing capability, especially where smoldering fires are anticipated. Ionization detectors are often better than photoelectric detectors at sensing fast, flaming fires.

#### Construction

These detectors are constructed of off-white LEXAN®. SD355(T) plug-in, low-profile smoke detectors are designed to commercial standards and offer an attractive appearance.

#### Installation

SD355(T) plug-in detectors use a detachable mounting base to simplify installation, service and maintenance. Mount base on box which is at least 1.5 inches (3.81 cm) deep. Suitable boxes include:

- 4.0" (10.16 cm) square box with plaster ring.
- 4.0" (10.16 cm) octagonal box.
- 3.5" (8.89 cm) octagonal box.
- Single-gang box.

**NOTE:** Because of the inherent supervision provided by the SLC loop, **end-of-line resistors** are not required. Wiring "T-taps" or branches are permitted for Style 4 (Class B) wiring. SD355R mounts in a D355PL or DNR(W) duct detector housing.

## Operation

Each SD355/T/R uses one of 99 possible addresses on the MS-9200 series and up to 318 (159 on each loop) on the MS-9600 series Signaling Line Circuit (SLC). It responds to regular polls from the system and reports its type and status.

The SD355/T/R addressable photoelectric sensor's unique unipolar chamber responds quickly and uniformly to a broad range of smoke conditions and can withstand wind gusts up to 4,000 feet-per-minute (20 m/sec.) without sending an alarm level signal. Because of its unipolar chamber, the SD355/T/R is approximately two times more responsive than most photoelectric sensors. This makes it a more stable detector.

## Detector Sensitivity Test

Each detector can have its sensitivity tested (required per NFPA 72, Chapter 14 on *Inspection, Testing and Maintenance*) when installed/connected to a MS-9200 series or MS-9600 series addressable fire alarm control panel. The results of the sensitivity test can be printed off the MS-9200 series or MS-9600 series for record keeping.

## Specification

**Voltage range:** 15 – 32 VDC (peak).

**Standby current:** 300 µA @ 24 VDC.

**LED current:** 6.5 mA @ 24 VDC (latched "ON").

**Air velocity:** 4,000 ft./min. (20 m/sec.) maximum.

**Diameter:** 6.1" (15.5 cm) installed in B350LP base.

**Height:** 2.1" (5.33 cm) installed in B350LP base.

**Weight:** 3.6 oz. (102 g).

**Operating temperature range:** for **SD355(A):** 0°C to 49°C (32°F to 120°F); for **SD355T(A):** 0°C to 38°C (32°F to 100°F).  
**SD355R(A):** installed in a DNR(W) -20°C to 70°C (-4°F to 158°F).

**Temperature:** 0°C – 49°C (32°F – 120°F).

**Relative humidity:** 10% – 93%, non-condensing.

## Listings

Listings and approvals below apply to the SD355(A) and SD355T(A) detectors. In some cases, certain modules may not be listed by certain approval agencies, or listing may be in process. Consult factory for latest listing status.

- UL Listed, file S1059.
- ULC Listed, file S1059.
- CSFM approved: file 7272-0075:194.
- MEA approved: file 243-02-E.
- FM approved.

## Product Line Information

**NOTE:** "A" suffix indicates ULC-Listed model.

**SD355:** Addressable photoelectric detector; B350LP base included.

**SD355A:** Same as SD355 with ULC Listing (B350LPA base included).

**SD355T:** Same as SD355 but with **thermal** element; B350LP base included.

**SD355TA:** Same as SD355T with ULC Listing (B350LPA base included).

**SD355R:** Remote test capable addressable photoelectric detector for use with a D355PL or DNR(W) duct detector housing.

**B350LP(A):** Plug-in detector base. Dimensions: 6.1" (15.5 cm). Mounting: 4.0" (10.16 cm) square box with or without plaster ring, 4.0" (10.16 cm) octagonal box, 3.5" (8.89 cm) octagonal box, or single-gang box. All mounting boxes have a minimum depth of 1.5" (3.81 cm).

**B224RB(A):** Plug-in System Sensor **relay** detector base. **Diameter:** 6.2" (15.75 cm). **Mounting:** 4.0" (10.16 cm) square box with or without plaster ring, 4.0" (10.16 cm) octagonal box, or 3.5" (8.89 cm) octagonal box. All mounting boxes have a minimum depth of 1.5" (3.81 cm).

**B224BI(A):** Plug-in System Sensor **isolator** detector base. Maximum 25 devices between isolator bases (*see DF-52389*). **Diameter:** 6.2" (15.75 cm). **Mounting:** 4.0" (10.16 cm) square box with or without plaster ring, 4.0" (10.16 cm) octagonal box, or 3.5" (8.89 cm) octagonal box. All mounting boxes have a minimum depth of 1.5" (3.81 cm).

**B200SR:** Sounder base capable of producing temporal-3 or steady sound output.

### ACCESSORIES:

**RA100Z(A):** Remote LED annunciator. 3 – 32 VDC. Mounts to a U.S. single-gang electrical box. *For use with B501(A) and B350LP(A) bases only.*

**SMK400E:** Surface mounting kit provides for entry of surface wiring conduit. *For use with B501(A) base only.*

**RMK400:** Recessed mounting kit. *For use with B501(A) base only.*

**M02-04-00:** Test magnet.

**M02-09-00:** Test magnet with telescoping handle.

**XR2B:** Detector removal tool. Allows installation and/or removal of detector heads from bases in high ceiling applications.

**XP-4:** Extension pole for XR2B. Comes in three 5-foot (1.524 m) sections.

**T55-127-010:** Detector removal tool without pole.

**BCK-200B:** Black detector covers, box of 10 .

**WCK-200B:** White detector covers, box of 10 .

FlashScan® registered trademark of Honeywell International Inc. Bayblend® is a registered trademark of Bayer Corporation.  
©2010 by Honeywell International Inc. All rights reserved. Unauthorized use of this document is strictly prohibited.



This document is not intended to be used for installation purposes.  
We try to keep our product information up-to-date and accurate.  
We cannot cover all specific applications or anticipate all requirements.  
All specifications are subject to change without notice.

For more information, contact Fire•Lite Alarms. Phone: (800) 627-3473, FAX: (877) 699-4105.  
[www.firelite.com](http://www.firelite.com)

**Wheelock® Exceder™****Horns and Strobes****Audio/Visual Devices****General**

The Wheelock® Exceder™ Series of notification appliances feature a sleek modern design and numerous features including eight candela options in one appliance, low current draw, no tools needed for setting changes, 12/24 VDC operation, universal mounting base and multiple mounting options.

Models with an audible feature 3 sound settings (90, 95, 99 dB). All switches to change settings can be set without the use of a tool and are located behind the appliance to prevent tampering. Wall models feature voltage test points to take readings with a voltage meter for troubleshooting and AHJ inspection.

The Wheelock® Exceder™ Series of wall and ceiling notification appliances feature a Universal Mounting Base (UMB) designed to simplify the installation and testing of horns, strobes, and combination horn strobes. The separate universal mounting base can be pre-wired to allow full testing of circuit wiring before the appliance is installed and the surface is finished. It comes complete with a contact cover for protection against dirt, dust, paint and damage to the contacts. The contact cover also acts as a shunting device to allow pre-wire testing for common wiring issues.

The contact cover is polarized to prevent it from being installed incorrectly and prevents the appliance from being installed while it is on the UMB. When the contact cover is removed the circuit will show an open until the appliance is installed. The UMB allows for consistent installation and easy replacement of appliances if required. Wall models provide an optional locking screw for extra secure installation, while the ceiling models provide a captive screw to prevent the screw from falling during installation.

**Features**

- Multiple voltages
- Voltage test points for quick troubleshooting and easy spot-checking (wall models only)
- 3 audible settings (90, 95, 99 dB)
- 8 Candela settings
  - Wall - 15/1575/30/75/95/110/135/185
  - Ceiling - 15, 30, 60, 75, 95, 115, 150, 177
- Finger-slide switches
- Sleek modern aesthetics
- Common base for wall and ceiling with 5 mounting options:
  - 1-gang
  - 2-gang
  - 4 inch square
  - 3.5 inch octagonal
  - 4 inch octagonal

**Compatibility and Requirements**

- Synchronize using Wheelock Sync Modules, or panels with built-in Wheelock patented sync protocol.
- Compatible with UL “Regulated Voltage” using filtered VDC or unfiltered VRMS input voltage
- Strobes produce one flash per second over the Regulated Voltage range.

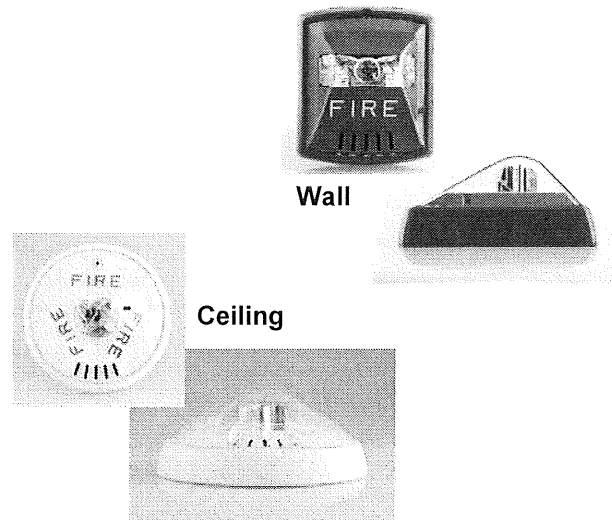
**General Notes**

- All candela ratings represent minimum effective strobe intensity based on UL Standard 1971.
- Series Exceder Strobe products are Listed under UL Standards 1971 and 464 for indoor use with a temperature range of 32°F to 120°F (0°C to 49°C) and maximum humidity of 93% (± 2%) UL 464 (85% UL 1971).
- Series Exceder horns are under UL Standard 464 for audible signal appliances (Indoor use only).
- Product naming conventions: The Exceder line's model codes break down into easy-to-remember codes. HN = Horn, ST = Strobe, HS = Horn-strobe, C = Ceiling Mount, W = White, and R = Red. So “STRC” can be read as “Strobe, Red, Ceiling-mount.”, and “HSW” is “Horn-strobe, white, wall-mount.”
- Refer to your fire alarm panel or power supply manual when calculating the number of devices allowed per circuit.

**Architects/Engineers Specifications**

The notification appliances shall be Wheelock Exceder Series HS Audible Strobe appliances, Series ST Visual Strobe appliances and Series HN Audible appliances or approved equals. The Series HS and ST Strobes shall be listed for UL Standard 1971 (Emergency Devices for the Hearing-Impaired) for Indoor Fire Protection Service. The Series HS and HN Audibles shall be UL Listed under Standard 464 (Fire Protective Signaling). All Series shall meet the requirements of FCC Part 15 Class B. All inputs shall be compatible with standard reverse polarity supervision of circuit wiring by a Fire Alarm Control Panel (FACP) with the ability to operate from 8 to 33 VDC. Indoor wall models shall incorporate voltage test points for easy voltage inspection.

The Series HS Audible Strobe and ST Strobe appliances shall produce a flash rate of one flash per second over the Regulated Voltage Range and shall incorporate a Xenon flashtube enclosed in a rugged Lexan® lens. The Series shall be of low current design. Where Multi-Candela appliances are specified, the strobe intensity shall have 8 field selectable settings at 15,

15/75, 30, 75, 95, 110, 135, 185 candela for wall mount and 15, 30, 60, 75, 95, 115, 150, 177 candela for ceiling mount. The selector switch for selecting the candela shall be tamper resistant. The 15/75 candela strobe shall be specified when 15 candela UL Standard 1971 Listing with 75 candela on-axis is required (e.g. ADA compliance). Appliances with candela settings shall show the candela selection in a visible location at all times when installed.

The audible shall have a minimum of three field selectable settings for dBA levels and shall have a choice of continuous or temporal (Code 3) audible outputs.

#### MOUNTING OPTIONS

The Series HS Audible Strobe, ST Strobe and Series HN Audible shall incorporate a patented Universal Mounting Base that shall allow mounting to a single-gang, double-gang, 4" square, 3.5" octagonal, 4" octagonal or 100mm European type back boxes. Two wire appliance wiring shall be capable of directly connecting to the mounting base. Continuity checking of the entire NAC circuit prior to attaching any notification appliances shall be allowed. Product shall come with contact cover to protect contact springs. Removal of an appliance shall result in a supervision fault condition by the Fire Alarm Control Panel (FACP). The mounting base shall be the same base among all horn, strobe, horn strobe, wall and ceiling models. All notification appliances shall be backwards compatible.

#### PHYSICAL SPECIFICATIONS

The Series HS and ST wall models shall have a low profile measuring 5.24" H x 4.58" W x 2.19" D. Series HN wall shall measure 5.24" H x 4.58" W x 1.6" D. The Series HSC and STC

shall be round and have a low profile with a diameter of 6.68" x 2.63" D. Series HNC ceiling shall have a diameter of 6.68" x 1.50" D.

#### SYNCHRONIZATION

When synchronization is required, the appliance shall be compatible with Wheelock's SM, DSM Sync Modules, Wheelock Power Supplies or other manufacturer's panels with built-in Wheelock Patented Sync Protocol. The strobes shall not drift out of synchronization at any time during operation. If the sync protocol fails to operate, the strobe shall revert to a non-synchronized flash-rate and still maintain one flash per second over its Regulated Voltage Range. The appliance shall also be designed so that the audible signal may be silenced while maintaining strobe activation when used with Wheelock synchronization protocol.

#### Standards and Codes

Modules in this series comply with UL Standard 1971, UL Standard 464, California State Fire Marshal (CSFM), and ULC.

#### Agency Listings

These listings and approvals apply to the modules specified in this document. In some cases, certain modules or applications may not be listed by certain approval agencies, or listing may be in process. Consult factory for latest listing status.

- **UL Listed:** S5391 (Strobes); E5946 (Horns, Horn/strobes).
- **ULC Listed**
- **CSFM Listed:** 7125-0785:168.

### Specification & Ordering Information

Model	Strobe Candela	12/24 VDC	Mounting Options
<b>Horn Strobes</b>			
HSR	15, 15/75, 30, 75, 95, 110, 135, 185	X	Universal Mounting Base
HSW	15, 15/75, 30, 75, 95, 110, 135, 185	X	Universal Mounting Base
HSRC	15, 30, 60, 75, 95, 115, 150, 177	X	Universal Mounting Base
HSWC	15, 30, 60, 75, 95, 115, 150, 177	X	Universal Mounting Base
<b>Strobes</b>			
STR	15, 15/75, 30, 75, 95, 110, 135, 185	X	Universal Mounting Base
STW	15, 15/75, 30, 75, 95, 110, 135, 185	X	Universal Mounting Base
STRC	15, 30, 60, 75, 95, 115, 150, 177	X	Universal Mounting Base
STWC	15, 30, 60, 75, 95, 115, 150, 177	X	Universal Mounting Base
<b>Horns</b>			
HNR	—	X	Universal Mounting Base
HNW	—	X	Universal Mounting Base
HNRC	—	X	Universal Mounting Base
HNWC	—	X	Universal Mounting Base
*12 VDC models feature 15 and 15/75 settings			
<b>NOTE:</b> Due to continuous development of Cooper Wheelock products, specifications and offerings are subject to change without notice in accordance with Cooper Wheelock Inc., dba Cooper Notification standard terms and conditions.			

Notifier® is a registered trademark of Honeywell International Inc.  
 Exceder is a trademark and Wheelock® is a registered trademark of Cooper Notification.  
 ©2010 by Honeywell International Inc. All rights reserved. Unauthorized use of this document is strictly prohibited.

This document is not intended to be used for installation purposes.  
 We try to keep our product information up-to-date and accurate.  
 We cannot cover all specific applications or anticipate all requirements.  
 All specifications are subject to change without notice.



Made in the U.S. A.

For more information, contact Notifier. Phone: (203) 484-7161, FAX: (203) 484-7118.  
[www.notifier.com](http://www.notifier.com)

# MMF-300(A) Series, MDF-300(A)

## Addressable Monitor Modules

 **Fire-LITE Alarms**  
by Honeywell

### Addressable Devices

#### General

Four different monitor modules are available for Fire•Lite's intelligent control panels to suit a variety of applications. Monitor modules are used to supervise a circuit of dry-contact input devices, such as conventional heat detectors and pull stations, or monitor and power a circuit of two-wire smoke detectors (MMF-302(A)).

**MMF-300(A)** is a standard-sized module (typically mounts to a 4" [10.16 cm] square box) that supervises either a Style D (Class A) or Style B (Class B) circuit of dry-contact input devices.

**MMF-301(A)** is a miniature monitor module a mere 1.3" (3.302 cm) H x 2.75" (6.985 cm) W x 0.5" (1.270 cm) D used to supervise a Style B (Class B) circuit of dry-contact input devices. Its compact design allows the MMF-301(A) to be mounted in a single-gang box behind the device it monitors.

**MMF-302(A)** is a standard-sized module used to monitor and supervise compatible two-wire, 24 volt, smoke detectors on a Style D (Class A) or Style B (Class B) circuit.

**MDF-300(A)** is a standard-sized dual monitor module used to monitor and supervise two independent two-wire Style B (Class B) dry-contact initiating device circuits (IDCs) at two separate, consecutive addresses in intelligent, two-wire systems.

LiteSpeed™ is a communication protocol developed by Fire•Lite Engineering that greatly enhances the speed of communication between analog intelligent devices. Intelligent devices communicate in a grouped fashion. If one of the devices within the group has new information, the panel CPU stops the group poll and concentrates on single points. The net effect is response speed greater than five times that of other designs.

#### MMF-300(A) Monitor Module

- Built-in type identification automatically identifies this device as a monitor module to the control panel.
- Powered directly by two-wire SLC loop. No additional power required.
- High noise (EMF/RFI) immunity.
- SEMS screws with clamping plates for ease of wiring.
- Direct-dial entry of address: 01 – 159 on MS-9600 series panels, 01 – 99 on other compatible systems.
- LED flashes during normal operation and latches on steady to indicate alarm.

The MMF-300(A) Monitor Module is intended for use in intelligent, two-wire systems, where the individual address of each module is selected using the built-in rotary switches. It provides either a two-wire or four-wire fault-tolerant Initiating Device Circuit (IDC) for normally-open-contact fire alarm and supervisory devices. The module has a panel-controlled LED indicator. The MMF-300(A) can be used to replace M300(A) modules in existing systems.

#### MMF-300(A) APPLICATIONS

Use to monitor a zone of four-wire smoke detectors, manual fire alarm pull stations, waterflow devices, or other normally-open dry-contact alarm activation devices. May also be used to monitor normally-open supervisory devices with special supervisory indication at the control panel. Monitored circuit

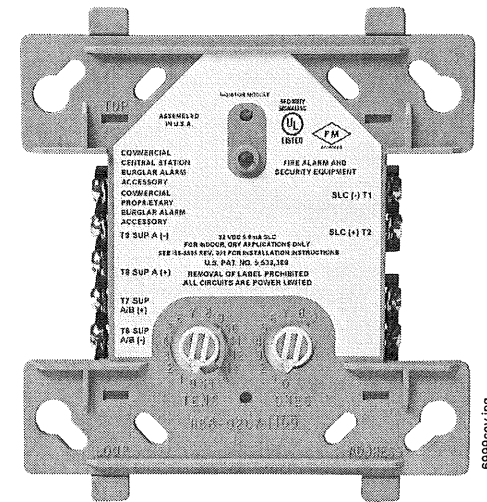

MMF-300(A) (Type H)

may be wired as an NFPA Style B (Class B) or Style D (Class A) Initiating Device Circuit. A 47K ohm End-of-Line Resistor (provided) terminates the Style B circuit. No resistor is required for supervision of the Style D circuit.

#### MMF-300(A) OPERATION

Each MMF-300(A) uses one of the available module addresses on an SLC loop. It responds to regular polls from the control panel and reports its type and the status (open/normal/short) of its Initiating Device Circuit (IDC). A flashing LED indicates that the module is in communication with the control panel. The LED latches steady on alarm (subject to current limitations on the loop).

#### MMF-300(A) SPECIFICATIONS

**Nominal operating voltage:** 15 to 32 VDC.

**Maximum current draw:** 5.0 mA (LED on).

**Average operating current:** 350  $\mu$ A (LED flashing), 1 communication every 5 seconds, 47k EOL.

**Maximum IDC wiring resistance:** 40 ohms.

**EOL resistance:** 47K ohms.

**Temperature range:** 32°F to 120°F (0°C to 49°C).

**Humidity range:** 10% to 93% noncondensing.

**Dimensions:** 4.5" (11.43 cm) high x 4" (10.16 cm) wide x 1.25" (3.175 cm) deep. Mounts to a 4" (10.16 cm) square x 2.125" (5.398 cm) deep box.

## MMF-301(A) Mini Monitor Module

- Built-in type identification automatically identifies this device as a monitor module to the panel.
- Powered directly by two-wire SLC loop. No additional power required.
- High noise (EMF/RFI) immunity.
- Tinned, stripped leads for ease of wiring.
- Direct-dial entry of address: 01 – 159 on MS-9600 series panels, 01 – 99 on other compatible systems

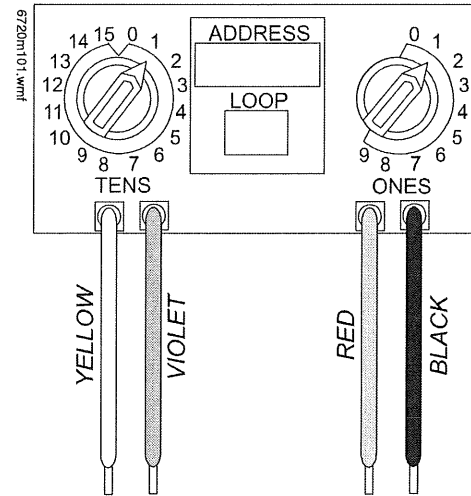

The MMF-301(A) Mini Monitor Module can be installed in a single-gang junction directly behind the monitored unit. Its small size and light weight allow it to be installed without rigid mounting. The MMF-301(A) is intended for use in intelligent, two-wire systems where the individual address of each module is selected using rotary switches. It provides a two-wire initiating device circuit for normally-open-contact fire alarm devices. The MMF-301(A) can be used to replace M301(A) modules in existing systems.

### MMF-301(A) APPLICATIONS

Use to monitor a single device or a zone of four-wire smoke detectors, manual fire alarm pull stations, waterflow devices, or other normally-open dry-contact devices. May also be used to monitor normally-open supervisory devices with special supervisory indication at the control panel. Monitored circuit/device is wired as an NFPA Style B (Class B) Initiating Device Circuit. A 47K ohm End-of-Line Resistor (provided) terminates the circuit.

### MMF-301(A) OPERATION

Each MMF-301(A) uses one of the available module addresses on an SLC loop. It responds to regular polls from the control panel and reports its type and the status (open/normal/short) of its Initiating Device Circuit (IDC).

### MMF-301(A) SPECIFICATIONS

Nominal operating voltage: 15 to 32 VDC.

**Average operating current:** 350  $\mu$ A, 1 communication every 5 seconds, 47k EOL; 600  $\mu$ A Max. (Communicating, IDC Shorted).

**Maximum IDC wiring resistance:** 40 ohms.

**Maximum IDC Voltage:** 11 Volts.

**Maximum IDC Current:** 400  $\mu$ A.

**EOL resistance:** 47K ohms.

**Temperature range:** 32°F to 120°F (0°C to 49°C).

**Humidity range:** 10% to 93% noncondensing.

**Dimensions:** 1.3" (3.302 cm) high x 2.75" (6.985 cm) wide x 0.65" (1.651 cm) deep.

**Wire length:** 6" (15.24 cm) minimum.

## MMF-302(A) Interface Module

- Supports compatible two-wire smoke detectors.
- Supervises IDC wiring and connection of external power source.
- High noise (EMF/RFI) immunity.
- SEMS screws with clamping plates for ease of wiring.
- Direct-dial entry of address: 01 – 159 on MS-9600 series panels, 01 – 99 on other compatible systems.
- LED flashes during normal operation.
- LED latches steady to indicate alarm on command from control panel.

The MMF-302(A) Interface Module is intended for use in intelligent, addressable systems, where the individual address of each module is selected using built-in rotary switches. This module allows intelligent panels to interface and monitor two-wire conventional smoke detectors. It transmits the status (normal, open, or alarm) of one full zone of conventional detectors back to the control panel. All two-wire detectors being monitored must be UL compatible with the module. The MMF-302(A) can be used to replace M302(A) modules in existing systems.

### MMF-302 (A) APPLICATIONS

Use the MMF-302(A) to monitor a zone of two-wire smoke detectors. The monitored circuit may be wired as an NFPA Style B (Class B) or Style D (Class A) Initiating Device Circuit. A 3.9 K ohm End-of-Line Resistor (provided) terminates the end of the Style B or D (class B or A) circuit (maximum IDC loop resistance is 25 ohms). Install ELR across terminals 8 and 9 for Style D application.

### MMF-302(A) OPERATION

Each MMF-302(A) uses one of the available module addresses on an SLC loop. It responds to regular polls from the control panel and reports its type and the status (open/normal/short) of its Initiating Device Circuit (IDC). A flashing LED indicates that the module is in communication with the control panel. The LED latches steady on alarm (subject to current limitations on the loop).

### MMF-302(A) SPECIFICATIONS

**Nominal operating voltage:** 15 to 32 VDC.

**Maximum current draw:** 5.1 mA (LED on).

**Maximum IDC wiring resistance:** 25 ohms.

**Average operating current:** 300  $\mu$ A, 1 communication and 1 LED flash every 5 seconds, 3.9k eol.

**EOL resistance:** 3.9K ohms.

**External supply voltage (between Terminals T3 and T4):** DC voltage: 24 volts power limited. Ripple voltage: 0.1 Vrms maximum. Current: 90 mA per module maximum.

**Temperature range:** 32°F to 120°F (0°C to 49°C).

**Humidity range:** 10% to 93% noncondensing.

**Dimensions:** 4.5" (11.43 cm) high x 4" (10.16 cm) wide x 1.25" (3.175 cm) deep. Mounts to a 4" (10.16 cm) square x 2.125" (5.398 cm) deep box.



## MDF-300(A) Dual Monitor Module

The MDF-300(A) Dual Monitor Module is intended for use in intelligent, two-wire systems. It provides two independent two-wire initiating device circuits (IDCs) at two separate, consecutive addresses. It is capable of monitoring normally open contact fire alarm and supervisory devices. The module has a single panel-controlled LED.

**NOTE:** The MDF-300(A) provides two Style B (Class B) IDC circuits ONLY. Style D (Class A) IDC circuits are NOT supported in any application.

### MDF-300(A) SPECIFICATIONS

**Normal operating voltage range:** 15 to 32 VDC.

**Maximum current draw:** 6.4 mA (LED on).

**Average operating current:** 750  $\mu$ A (LED flashing).

**Maximum IDC wiring resistance:** 1,500 ohms.

**Maximum IDC Voltage:** 11 Volts.

**Maximum IDC Current:** 240  $\mu$ A

**EOL resistance:** 47K ohms.

**Maximum SLC Wiring resistance:** 40 Ohms.

**Temperature range:** 32° to 120°F (0° to 49°C).

**Humidity range:** 10% to 93% (non-condensing).

**Dimensions:** 4.5" (11.43 cm) high x 4" (10.16 cm) wide x 2.125" (5.398 cm) deep.

### MDF-300(A) AUTOMATIC ADDRESSING

The MDF-300(A) automatically assigns itself to two addressable points, starting with the original address. For example, if the MDF-300(A) is set to address "26", then it will automatically assign itself to addresses "26" and "27".

**NOTE:** "Ones" addresses on the MDF-300(A) are 0, 2, 4, 6, or 8 only. Terminals 6 and 7 use the first address, and terminals 8 and 9 use the second address.



#### CAUTION:

Avoid duplicating addresses on the system.

## Installation

MMF-300(A), MMF-302(A), and MDF-300(A) modules mount directly to a standard 4" (10.16 cm) square, 2.125" (5.398 cm) deep, electrical box. They may also be mounted to the SMB500 surface-mount box. Mounting hardware and installation instructions are provided with each module. All wiring must conform to applicable local codes, ordinances, and regulations. These modules are intended for power-limited wiring only.

The MMF-301(A) module is intended to be wired and mounted without rigid connections inside a standard electrical box. All wiring must conform to applicable local codes, ordinances, and regulations.

## Agency Listings and Approvals

In some cases, certain modules may not be listed by certain approval agencies, or listing may be in process. Consult factory for latest listing status.

- **UL:** S2424
- **ULC:** S2424
- **FM Approved**
- **CSFM:** 7300-0075:0185
- **MEA:** 72-01-E

## Product Line Information

**NOTE:** "A" suffix indicates ULC-listed model.

**MMF-300(A):** Monitor module.

**MMF-301(A):** Monitor module, miniature.

**MMF-302(A):** Monitor module, two-wire detectors.

**MDF-300(A):** Monitor module, dual, two independent Class B circuits.

**SMB500:** Optional surface-mount backbox.

**NOTE:** See installation instructions and refer to the SLC Wiring Manual, PN 51309.

## Architects'/Engineers' Specifications

Specifications of these devices and all FireLite products are available from FireLite.

Fire-Lite® and LiteSpeed® are registered trademarks and FireWatch™ is a trademark of Honeywell International Inc.  
©2010 by Honeywell International Inc. All rights reserved. Unauthorized use of this document is strictly prohibited.



This document is not intended to be used for installation purposes.  
We try to keep our product information up-to-date and accurate.  
We cannot cover all specific applications or anticipate all requirements.  
All specifications are subject to change without notice.







Made in the U.S. A.

For more information, contact Fire•Lite Alarms. Phone: (800) 627-3473, FAX: (877) 699-4105.  
[www.firelite.com](http://www.firelite.com)

LEGEND

MOUNTING HEIGHT

-  SMOKE DETECTOR
-  VISUAL ONLY
-  AUDIO / VISUAL
-  MONITOR MODULE

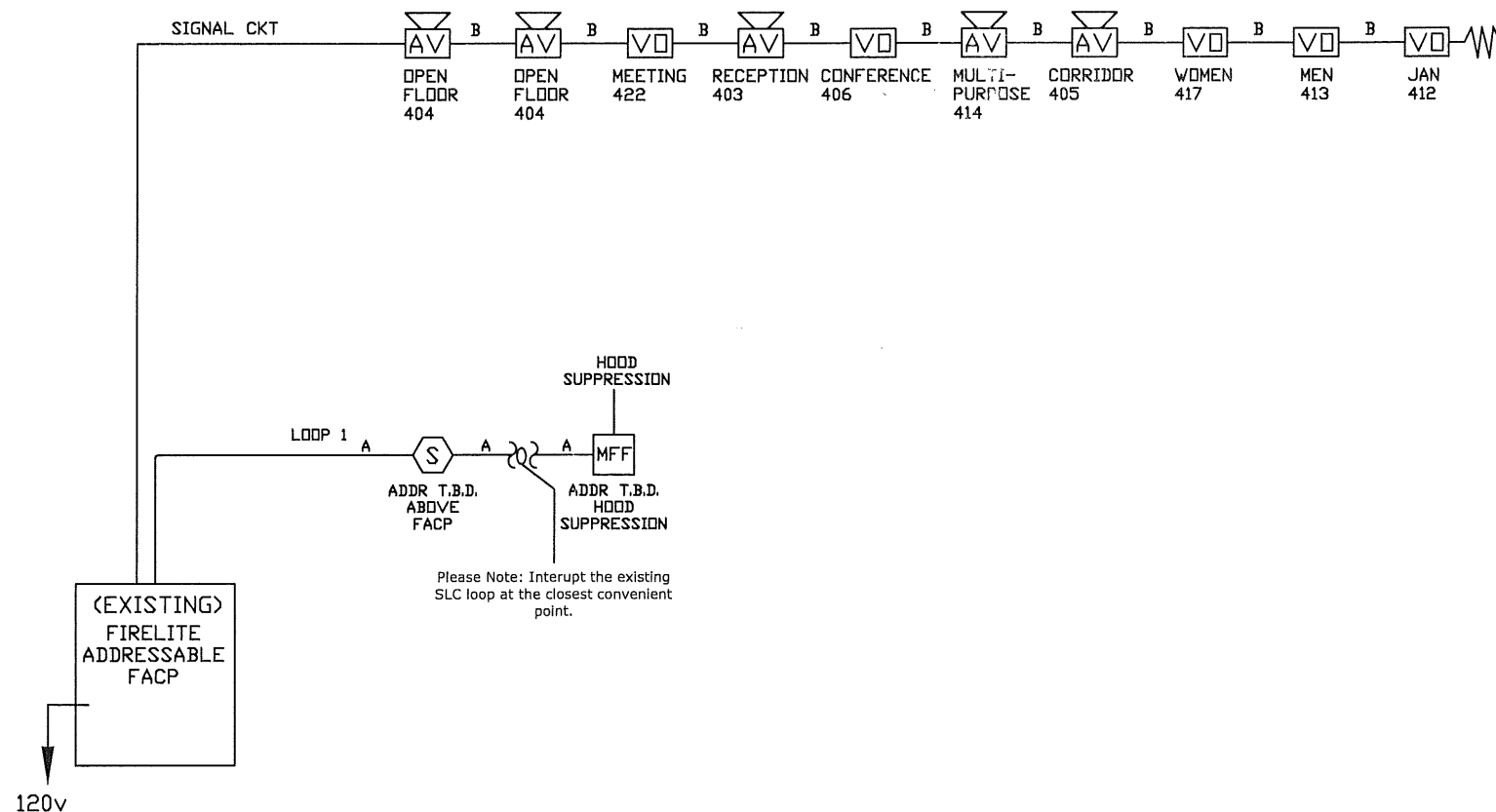

This drawing is a typical device layout, wiring is shown diagrammatically only. This drawing has been provided as an example ONLY. Riser does not necessarily indicate all devices and appliances. See floor plans and specification for location and quantities. The purchaser must accurately layout the initiating and notification devices in their proper zones/circuit. Note: All signal circuits have a 2.5 amp load limitation and a combined load limitation of 3.0 amps or 6.0 amps if XRM-24 is added to the panel. There can be 4 class B nac circuits or 2 class A nac circuits. REMOTE power supply has a 3.0 amp limitation per circuit and an 8.0 amp combined limitation for all 4 circuits. (see chart below for current vs. candela rating)

Room Size	Candela Rating	Load (amps)
20' x 20'	15 cd	0.08 amps
28' x 28'	30 cd	0.10 amps
45' x 45'	75 cd	0.15 amps
54' x 54'	110 cd	0.20 amps

- A 1 PR #12 AWG TWISTED-PAIR UNSHIELDED CABLE FPL GENESIS 4515, BELDEN 6020UL (Up to 10,000 ft)
- A 1 PR #14 AWG TWISTED-PAIR UNSHIELDED CABLE FPL GENESIS 4513, BELDEN 6120UL (Up to 8,000 ft)
- A 1 PR #16 AWG TWISTED-PAIR UNSHIELDED CABLE FPL GENESIS 4511, BELDEN 6220UL (Up to 4,500 ft)
- B 1 PR #12 AWG FPL CABLE
- D 1 PR #14 AWG FPL CABLE
- E 1 PR #16 AWG FPL CABLE
- F 2c #12 AWG CABLE
- G 2c #14 AWG CABLE
- H 1 PR #16 AWG TWISTED-PAIR SHIELDED CABLE FPL
- J 1 CAT5 CABLE

REVISION	DATE
REVISION	DATE
REVISION	DATE
REVISION	DATE
REVISION	DATE

SYSTEM WIRING RISER

PROJECT NAME	SCALE NTS
<b>400 CONGRESS ST.</b>	BY: <b>CJC</b>
PORTLAND, MAINE	CK BY:



Important! Duplicate Addresses on devices of different style is NOT an error in design or printing. All electronic devices MUST be placed in a heated room with temperature above 32 degrees. Never run wires parallel to any other wiring. Make sure to always run cables in separate raceways. Fire alarm wiring can emit noise that may affect other devices. Shielded cable can be used if cable is run near sensitive equipment.

SAVED AS:

**FLOOR PLAN**



**VISUAL ONLY**



**AUDIO/VISUAL**

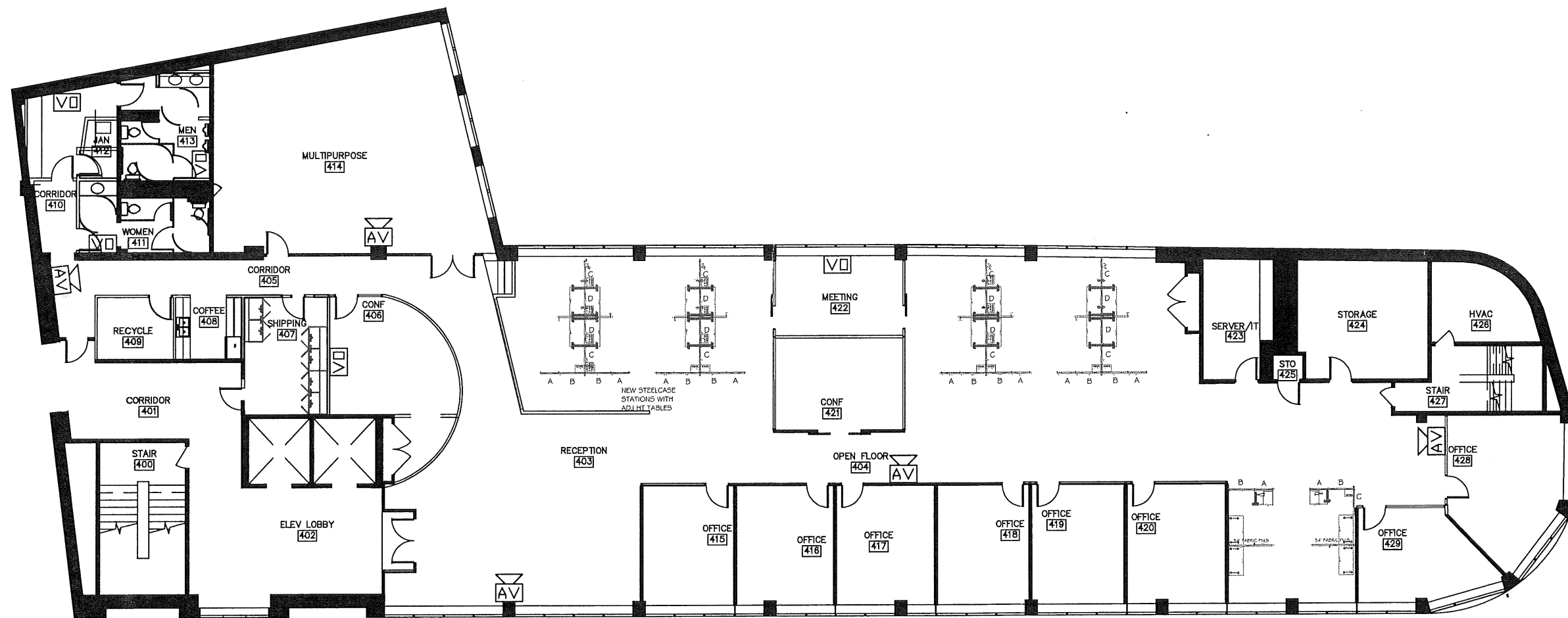

REVISION 2	DATE:
REVISION 1	DATE:
REVISION 0 SUBMITTAL	DATE: 1/12/11

**SYSTEM WIRING RISER**

PROJECT NAME	SCALE NTS
<b>400 Congress St. 4th Floor</b>	BY: <b>CJC</b>
Portland, MAINE	CK BY:



SAVED AS:

# SYSTEM MATRIX

SYSTEM INPUTS		SYSTEM OUTPUTS													
		CONTROL UNIT ACTIVATION								NOTIFICATION					
		A	B	C	D	E	F	G	H	I	J	K	L	M	N
1	MANUAL FIRE ALARM PULL STATION	●	●					●	●	●					
2	AREA SMOKE DETECTOR	●	●					●	●	●					
3	AREA HEAT DETECTOR	●	●					●	●	●					
4	FIRE ALARM AC POWER FAILURE					●	●	●	●						
5	FIRE ALARM SYSTEM LOW BATTERY					●	●	●	●						
6	OPEN CIRCUIT					●	●	●	●						
7	GROUND FAULT					●	●	●	●						
8	NOTIFICATION APPLIANCE CIRCUIT SHORT					●	●	●	●						
9															
10															

REVISION 2	DATE:
REVISION 1	DATE:
REVISION 0 SUBMITTAL	DATE: 1/12/11

SYSTEM WIRING RISER	
PROJECT NAME <b>400 Congress St. 4th Floor</b> Portland, MAINE	SCALE NTS BY: <b>cjc</b> CK BY:



**NORRIS INC**  
Prepared For Tomorrow. Delivered Today.

SAVED AS: