

Form 11-106

DISPLAY THIS CARD ON PRINCIPAL FRONTAGE OF WORK CITY OF PORTLAND

Please Read
Application And
Notice. If Any
Attached

REPAIR/ALTERATION/RECONSTRUCTION

PERMIT

Permit Number: 140196

PERMIT ISSUED:

This is to certify that Louise and Kathryn P. & Family who

has permission to Change of Use of Real Estate File, Inc. Group

AT 147 Spring St. 059 061 001

MAR 26 2011

CITY OF PORTLAND

provided that the person or persons, firm or corporation accepting this permit shall comply with all of the provisions of the Statutes of Maine and of the ordinances of the City of Portland regulating the construction, maintenance and use of buildings and structures, and of the application on file in this department.

Apply to Public Works for street line and grade if nature of work requires such information.

Notification of inspection must be given and when permit is issued before this building is entered, altered or enclosed in any way. NOTICE IS REQUIRED.

A certificate of occupancy must be procured by owner before this building or part thereof is occupied.

OTHER REQUIRED APPROVALS:

Fire Dept. [Signature]

Health Dept. _____

Appeal Board _____

Other _____

[Signature]
140196

PENALTY FOR REMOVING THIS CARD

City of Portland, Maine - Building or Use Permit Application

387 Congress Street, 04101 Tel: (207) 874-8700, Fax: (207) 874-8716

Permit No:	04-0590	City:	0054 DC1001
------------	---------	-------	-------------

Structural Construction:	Owner Name:	Owner Address:	Zone:
132 Spring St	Douglas Kating, E.A.	132 Spring St	B.3
Business Name:	Contractor Name:	Contractor Address:	
	James B. White	CITY OF PORTLAND 2 Parcel Court West	
Tenant/Agent's Name:	Phone:	Permit Type:	
		Change of Use - Commercial	

Permit Fee:	Proposed Use:	Permit Fee:	Cost of Work:	CEO District:
Pottery Store	Change of Use to Real Estate Office/tenant fit-up	\$384.00	\$32,000.00	2

FIRE DEPT:	INSPECTION:
<input checked="" type="checkbox"/> Approved <input type="checkbox"/> Denial	Use Group: <i>S</i> <i>5B</i>

Proposed Project Description:
Change of Use to Real Estate Office; tenant fit up

PROFESSIONAL ACTIVITY (PLANNING, ARCHITECTURE, ENGINEERING, SURVEYING)
 Action: Approved Approved w/Conditions Denial
 Signature: _____ Date: _____

Permit Taken By:	Date Applied For:	Zoning Approval		
kwd	10/17/2014	Special Zone or District:	Zoning Appeal:	Historic Preservation:

<p>This permit application does not preclude the Applicant(s) from meeting applicable State and Federal Rules.</p> <p>2. Building permits do not include plumbing, septic or electrical work.</p> <p>3. Building permits are void if work is not started within six (6) months of the date of issuance. False information may invalidate a building permit and stop all work.</p>	<input type="checkbox"/> Special <input type="checkbox"/> Historic <input type="checkbox"/> Flood Zone <input type="checkbox"/> Subdivision <input type="checkbox"/> Etc. Plan.	<input type="checkbox"/> Variance <input type="checkbox"/> Miscellaneous <input type="checkbox"/> Conditional Use <input type="checkbox"/> Expansion <input type="checkbox"/> Access	<input type="checkbox"/> No Historic Landmark <input type="checkbox"/> No Historic Key-Block <input type="checkbox"/> Historic Site <input type="checkbox"/> Approval <input type="checkbox"/> Approved w/Conditions <input type="checkbox"/> Other	
	My <input type="checkbox"/> Signature <input type="checkbox"/> Noted Date: <i>5/17/14</i>	Approved: _____ Date: _____	Approved: _____ Date: _____	Approved: _____ Date: _____

*Approved by _____
Specialty Engineer
Approved*

CERTIFICATION

I hereby certify that I am the owner of record of the named property, or that the proposed work is authorized by the owner of record and that I have been authorized by the owner to make this application as his authorized agent and I agree to conform to all applicable laws of this jurisdiction. In addition, if a permit for work described in the application is issued, I certify that the code official's authorized representative shall have the authority to enter all areas covered by such permit at any reasonable hour to enforce the provisions of the code(s) applicable to such permit.

 SIGNATURE OF APPLICANT ADDRESS DATE PHONE

 RESPONSIBLE PERSON IN CHARGE OF WORK, TITLE DATE TIME

May 12, 2004

Marge Schmoekal
Zoning Administrator
390 Congress Street
Portland, Maine 04101

Re: Commercial Interior Construction & Change of Use Application
132 Spring Street (1st Floor)

Marge:

For your review, I am submitting an "All Purpose Building Permit Application" for the above referenced property. As you may recall from our recent phone conversations, we are intending to change the use of the aft portion of this building (labeled on drawing No. 04-1500-10) to a commercially zoned unit as. Currently, the building is zoned in the following manner...

- First Floor: Approximately 706 square-foot commercially zoned & 689 square-foot residentially zoned. The commercial space is located along Spring Street, and there is a one bedroom / one bath apartment in the rear of the building which abuts the church. The apartment is to be removed and turned into a 'Class A' commercial space.
- Second: There is a three bedroom / two bath apartment, which occupies the entire second floor with the exception of the common vertical stairways. This apartment is approximately 1,680 square feet, and also has a deck overlooking Park Street, which is approximately 315 square feet. Your office has already approved this and a C.O. was given around February 15, 2004.
- Third: The third floor has a one bedroom / one bath apartment that is approximately 600 square feet and in addition has a 225 square foot deck that also looks down towards the Eastern Front.

My largest question/concern with this project became the lack of an existing sprinkler system in the building, and I therefore met with Lt. Gaylen McDougall on January 27, 2004.

He determined that the building was not in need of a sprinkler system and then verified his conclusion with Michael Nugent. I spoke with Mr. Nugent following my meeting with Lt. McDougall to confirm the thoughts of Mr. McDougall and this was agreed upon by both parties.

397D 1.3

We have demoed the first floor in order to determine what walls were bearing and so that myself and our architect could design the first floor space. We are intending to open our Real Estate office in this space, and I have enclosed plans depicting what we intend to do. I have drawn these plans myself as I am a Naval Architect and Engineer and so can explain any uncertainties that you may have.

Jim White of White Homes, 2 Farwell Court, Westbrook, Maine is the general contractor and he can be contacted at his pager @ 741-3141. I spoke with him this morning, and he will be glad to come visit your office if needed.

I will be supplying you with electrical & plumbing plans when they are completed. Most likely, before the end of next week. I would however appreciate getting the construction portion of the project approved by the City of Portland so that we can begin. In the meantime, we will be stocking the project. As mentioned in the application, we hope that the project will cost us about thirty-two thousand dollars.

I met with Deb Andrews at the building about a month ago and discussed what our limits were as we are in a historic building. We have gone through great pains, both in the design process and the sacrifices to the space in order to "ret usch" the building envelope in any manner. Everything with regards to the exterior will remain the same, with the exception of paint, which will be fully restored in the following months. This painting project alone will take about six weeks as we intend to make this building the jewel of the neighborhood.

I very much appreciate your time and effort.

Thank you for all your help.

Regards,



Christian Townsend
Townsend & Townsend, Inc.
92 Exchange Street
Portland, Maine

City of Portland, Maine - Building or Use Permit

189 Congress Street, 04101 Tel: (207) 874-8700. Fax: (207) 874-8716

Permit No:	Date Applied For:	CR#:
04-0391	05/22/04	039 101360

Location of Construction: 132 Spring St	Owner Name: Townsend Kathryn P &	Home Address: 132 Spring St	Phone:
Business Name:	Contractor Name: Lance B. White	Contractor Address: 2 Forest Court Westbrook	Phone: (207) 875-1161
License/Type's Name:	Phone:	Permit Type: Change of Use - Commercial	

Proposed Use: Change of Use to Real Estate Office; tenant fit-up	Proposed Project Description: Change of Use to Real Estate Office; tenant fit-up
---	---

Dept: Zoning Status: Approved with Conditions Reviewer: Miego Szamuskaj Approval Date: 05/20/2004

Notes: OK to Issue:

- 1) ANY exterior work requires a separate review and approval thru Historic Preservation. This property is located in a Historic District.
- 2) Separate permits shall be required for any new signage.
- 3) This permit is being approved on the basis of plans submitted. Any deviations shall require separate approvals before starting the work.

Dept: Building Status: Approved Reviewer: Mike Nugent Approval Date: 05/20/2004

Notes: OK to Issue:

- 1) Interior work ONLY

Dept: Fire Status: Approved with Conditions Reviewer: L. MacDonald Approval Date: 05/17/2004

Notes: OK to Issue:

- 1) Fire extinguishers shall be provided in accordance with NFPA 10 standards

THIS IS NOT A BOUNDARY SURVEY

MORTGAGE INSPECTION OF DEED BOOK 1363B PAGE 22 COUNTY Cumberland
 PLAN BOOK _____ PAGE _____ LOT _____

ADDRESS 152 Spring Street, Portland, Maine

Job Number: 447-01
 Inspection Date: 12.11.13
 Scale: 1"=10'
 File No: 48252

Buyers: Kathryn & Christian Townsend

Seller: Sara Winston Cox

Five Vacant Basement
 of per deed 12487-178

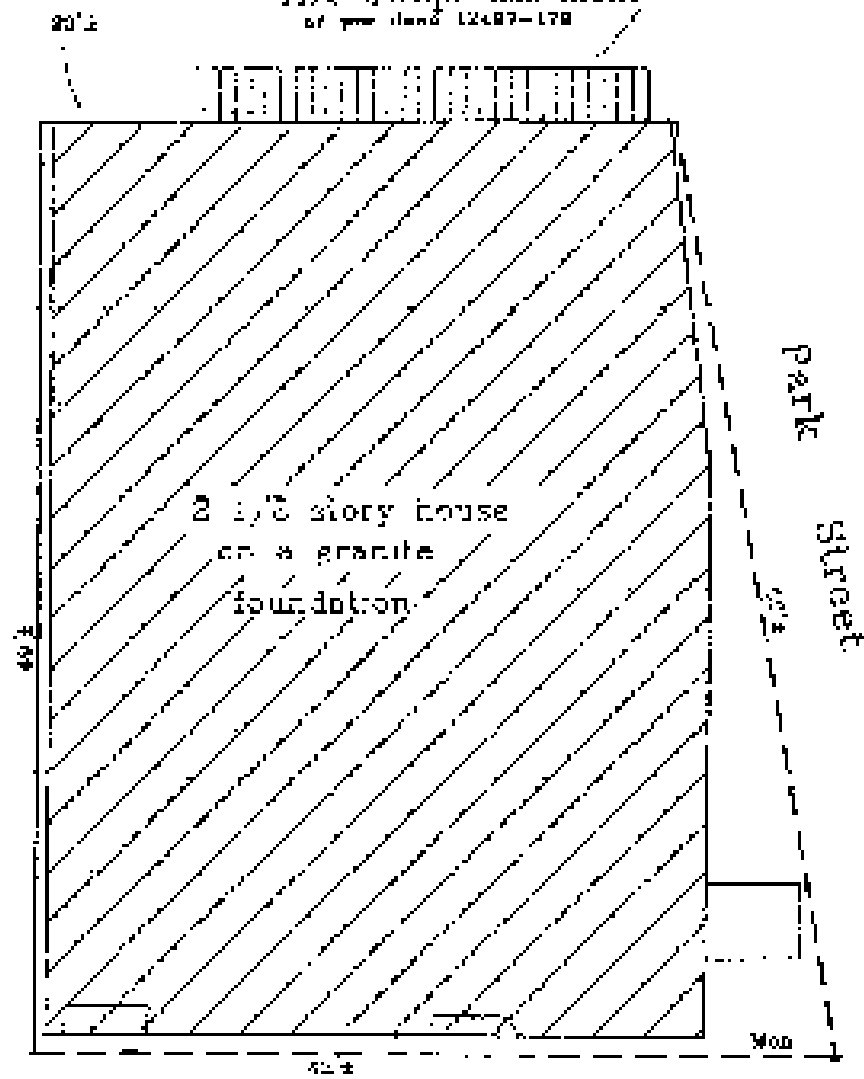

Spring Street

[Handwritten signature]

I HEREBY CERTIFY TO: Guaranty Title Corporation
Trust National Bank
and its title insurer

statements found did not conflict with the deed description.
 The existing setbacks do not violate local zoning requirements.
 As delineated on the Federal Emergency Management Agency Community
 Panel 200061 0015 D
 The structure does not fall within the special flood hazard zone.
 The land does not fall within the special flood hazard zone.
 A wetlands study has not been performed.

APPARENT EASEMENTS AND RIGHTS OF
 WAY ARE SHOWN UNDER ENCUMBRANCES.
 RECORDED OR NOT, MAY EXIST THIS
 SURVEY WILL NOT REVEAL ADJUTING
 UNLESS CONFESSED BY ANY.

Livingston - Hughes
 Professional Land Surveyors & Planners
 88 GUNN ROAD
 YACHTBUCKLE, MAINE 04088
 207-957-9761 phone 207-967-4851 fax

39 D 13

EX-1565-875020

File No: 20250702

EXHIBIT A - Deed

A certain lot or parcel of land with the buildings thereon situated on the southeasterly corner of Park and Spring Streets in Portland, County of Cumberland and State of Maine, bounded and described as follows, to wit:

Commencing at the NW corner of Park and Spring Streets; thence northeasterly by said Spring Street, forty-two and two tenths (42.2) feet to a point; thence southeasterly by an included angle of 55°, forty-eight and eight tenths (48.8) feet to the Park Street Church property; thence southeasterly by said Park Street Church property; thence easterly by said Park Street Church property, thirty-three and twenty-five hundredths (33.25) feet to Park Street; thence southeasterly by said Park Street forty-nine and forty five hundredths (49.45) feet to the point of beginning.

Also conveying any and all interest as recited in an Executed Deed and Agreement dated May 8, 1996 and recorded in the Cumberland County Registry of Deeds in Book 11497, Page 155.

RECEIVED
REGISTRY OF DEEDS

JUN 15 11 31 AM '44

CUMBERLAND COUNTY

John B. O'Brien

35013

EXIST. BEARING WALL ABOVE
 ← PM LALLY COL TO FR, WALL BELOW

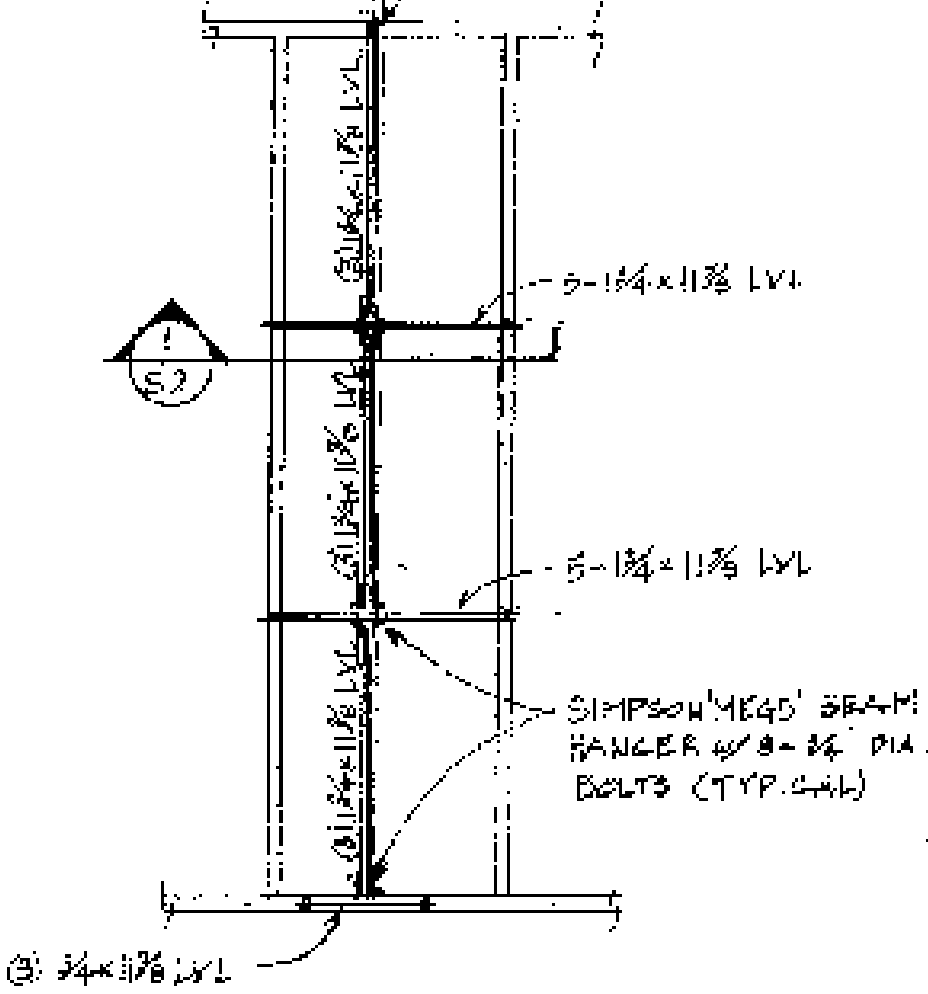

PARTIAL 2ND FLR. FRMG PLAN

5/2/04

DEPT. OF BUILDING INSPECTION
 CITY OF PORTLAND, ME
 MAY 12 2004
 35-D-13

Title: TOWNSEND BLDG
 132-134 SPRING ST
 PORTLAND, ME



ENGINEERING DESIGN PROFESSIONALS
 Consulting Engineers
 P.O. Box 575, Freeport, Maine 04032 (207)865-9835

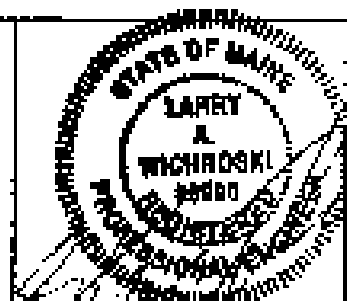

Job No: 20804
 Date: 5-1-04
 Name: LNK
 Sheet: 5-1

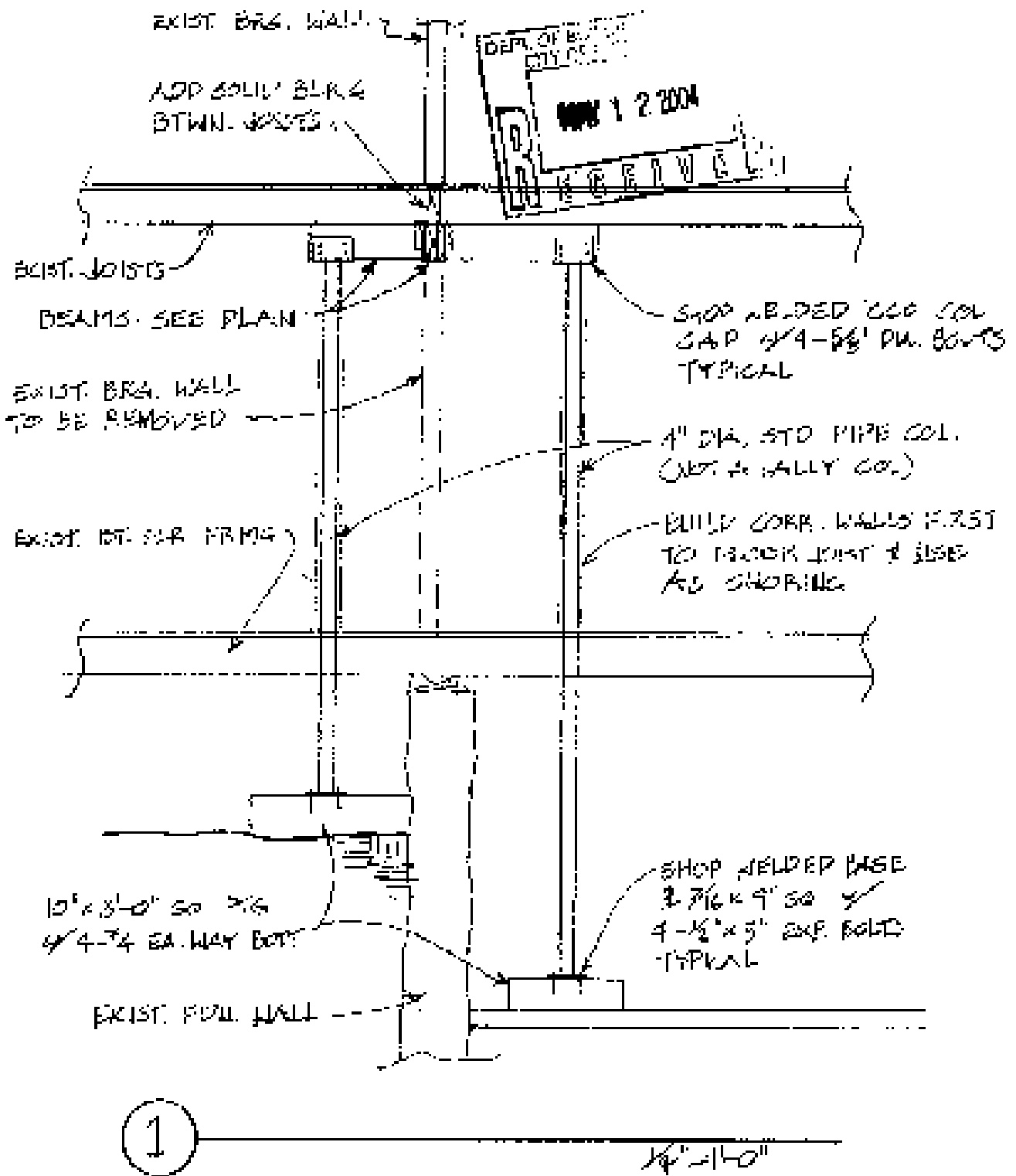

Title: FOLLESEND BLDG.
 132-134 SPRING ST.
 PORTLAND, ME



ENGINEERING DESIGN PROFESSIONALS
 Consulting Engineers
 P.O. Box 575, Freeport, Maine 04855 (207)865-9515

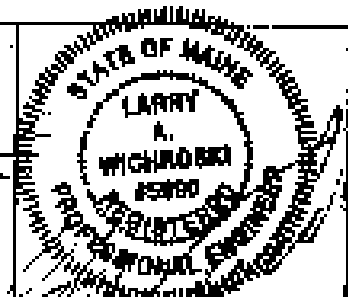

Job No: 20004
 Date: 5-1-04
 Name: LAW
 Sheet: 5-2

City of Portland, Maine - Building or Use Permit

389 Congress Street, 04101 Tel: (207) 874-8705, Fax: (207) 874-8716

Permit No:	Date Applied For:	CD#:
00-0956	05/12/2009	039 100300

Location of Construction: 177 Spring St	Owner Name: Townsend Kathryn E. &	Owner Address: 152 Spring St	Phone:
Permittee Name:	Contractor Name: James R. White	Contractor Address: 2 Maxwell Court Westbrook	Phone: (207) 878-3361
Owner/Owner's Name:	Phone:	Permit Type: Change of Use - Commercial	

Proposed Use: Change of Use to Real Estate Offices; tenant fit up	Proposed Project Description: Change of Use to Real Estate Offices; tenant fit up
--	--

Dept: Zoning Status: Approved with Conditions Reviewer: Marge Schmeckel Approval Date: 05/17/2009

Note: OK to Issue:

- 1) ANY exterior work requires a separate review and approval thru Historic Preservation. This property is located in a Historic District.
- 2) Separate permits shall be required for any new signage.
- 3) This permit is being approved on the basis of plans submitted. Any deviations shall require a separate approval before starting that work.

Dept: Building Status: Pending Reviewer: _____ Approval Date: _____

Note: OK to Issue:

Dept: Fire Status: Pending Reviewer: _____ Approval Date: _____

Note: OK to Issue:

04-0596

All Purpose Building Permit Application

If you or the property owner owes real estate or personal property taxes or user charges on any property within the City, payment arrangements must be made before permits of any kind are accepted.

Location/Address of Construction: <u>132 SPRING STREET - FORTLAND - ME</u>		
Total Square Footage of Proposed Structure <u>1520 SQ. FT.</u>	Square Footage of Lot <u>1682 SQ. FT.</u>	
Tax Assessor's Chart, Block & Lot Chart# <u>35</u> Block# <u>D</u> Lot# <u>13</u>	Owner <u>CHRISTIAN / KATHY TOWNSEND</u>	Telephone <u>842-2149</u>
Lessee/Buyer's Name (if Applicable): <u>/</u>	Applicant name, address & telephone: <u>30 STAFFAN ROAD S. FORTLAND (767-3679)</u>	Cost of Work: <u>\$32,000</u> Fee: \$ <u>307</u>
Current use: _____	If the location is currently vacant, what was prior use: <u>DELIA'S FURNERY</u>	
Approximately how long has it been vacant: <u>5 MONTHS</u>	Proposed use: <u>REAL ESTATE OFFICE</u>	
Contractor's name, address & telephone: <u>JAMES B. WHITE 2 PARKWAY COURT, WESTERBROOK</u>		
Who should we contact when the permit is ready: <u>CHRISTIAN TOWNSEND @ 232-9479</u>		
Mailing address: <u>87B-3361 (AGER @ 741-3141)</u>		
We will contact you by phone when the permit is ready. You must come in and pick up the permit and review the requirements before starting any work with a Plan Reviewer. A stop work order will be issued and a \$1000 fee if any work starts before the permit is picked up. PHONE:		

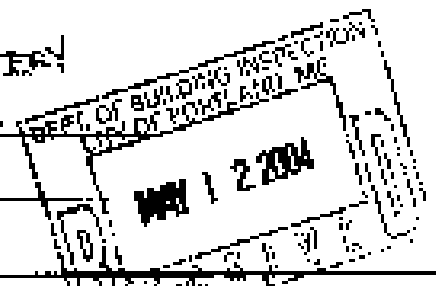

IF THE REQUIRED INFORMATION IS NOT INCLUDED IN THE SUBMISSIONS THE PERMIT WILL BE AUTOMATICALLY DENIED AT THE DISCRETION OF THE BUILDING/PLANNING DEPARTMENT, WE MAY REQUIRE ADDITIONAL INFORMATION IN ORDER TO APPROVE THIS PERMIT.

I hereby certify that I am the Owner of record of the named property, or that the owner of record authorized the proposed work and that I have been authorized by the owner to make this application as his/her authorized agent. I agree to submit to all applicable laws of the jurisdiction. In addition, if a permit for work described in this application is issued, I certify that the Code Officer's authorized representative who have the authority to enter all areas covered by this permit at any reasonable time to enforce the provisions of the codes applicable to the permit.

Signature of applicant: 	Date: <u>MAY 12/4</u>
---	-----------------------

This is NOT a permit, you may not commence ANY work until the permit is issued. If you are in a Historic District you may be subject to additional permitting and fees with the Planning Department on the 4th floor of City Hall