

T:\02_TFH Projects\0422_Chestnut Street\Construction Documents\05-Detail\0422-PanDetail-A5-1.dwg, 2/24/2008 10:26:28 AM, HP Design, 417500 Pds (E - A5).pds

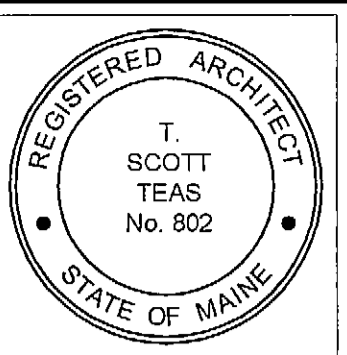

© 2005 TFH ARCHITECTS

CHESTNUT STREET LOFTS
URBAN REVITALIZATION PROJECT
BY CHESTNUT STREET LLC.
PORTLAND, MAINE

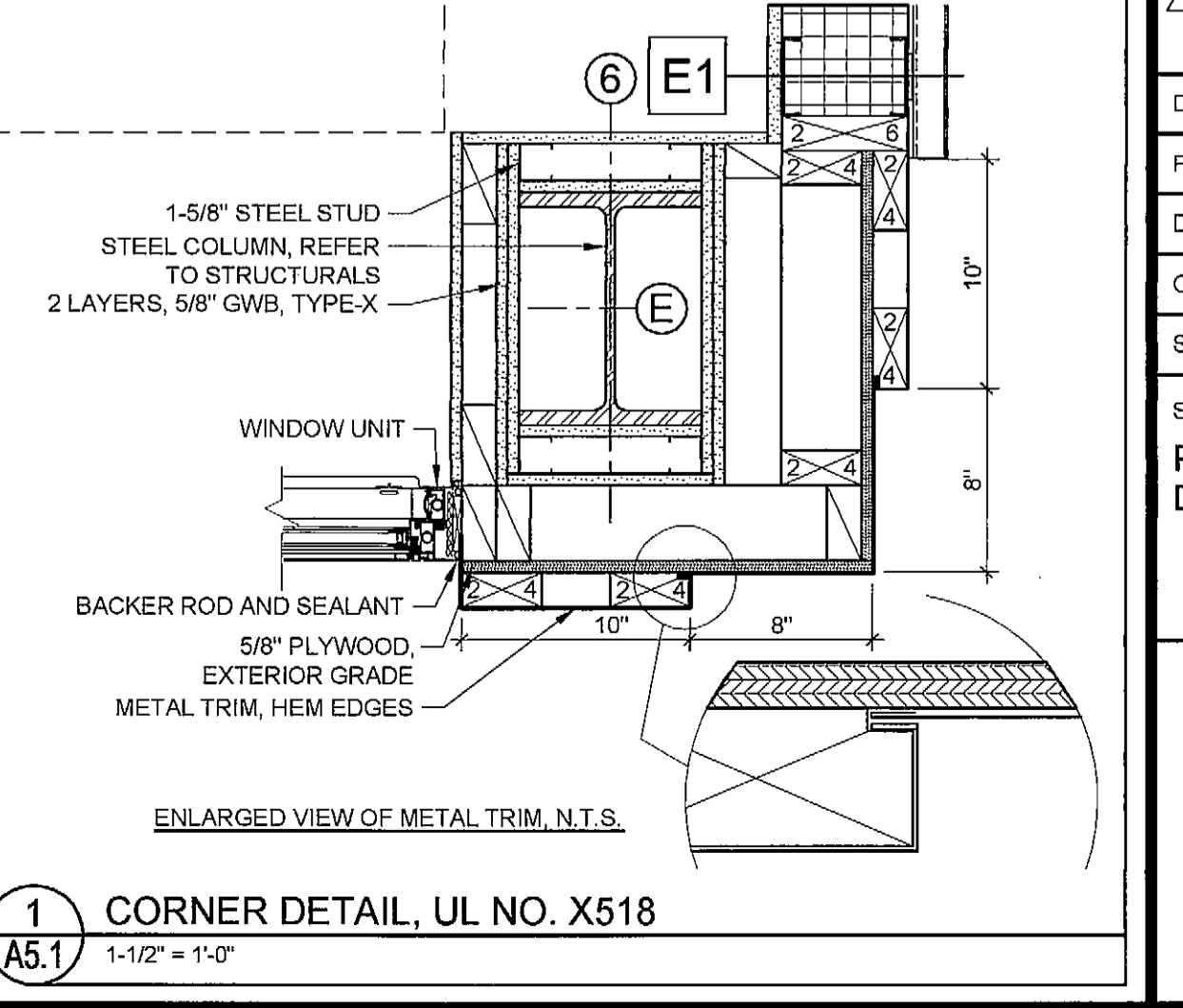
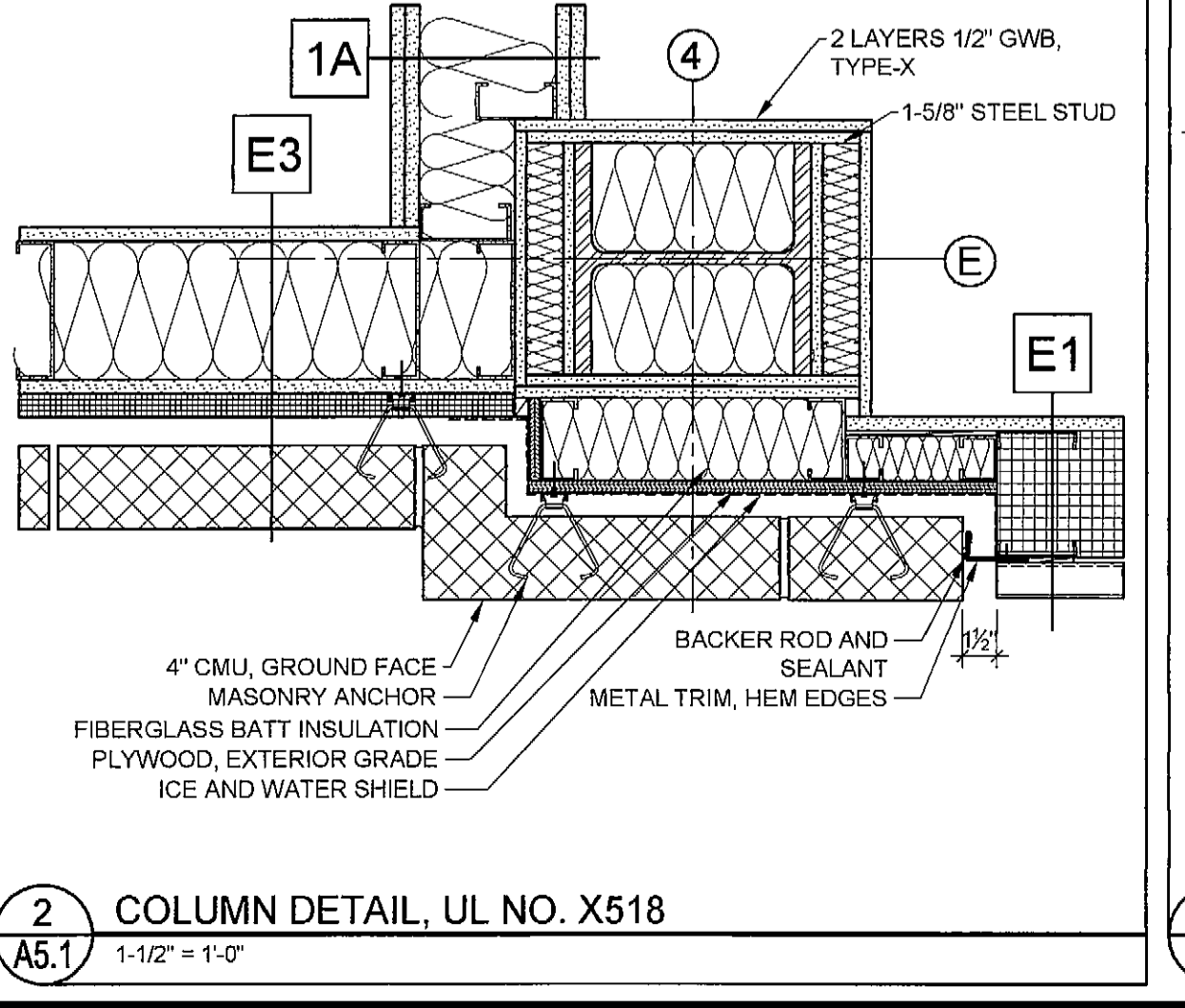
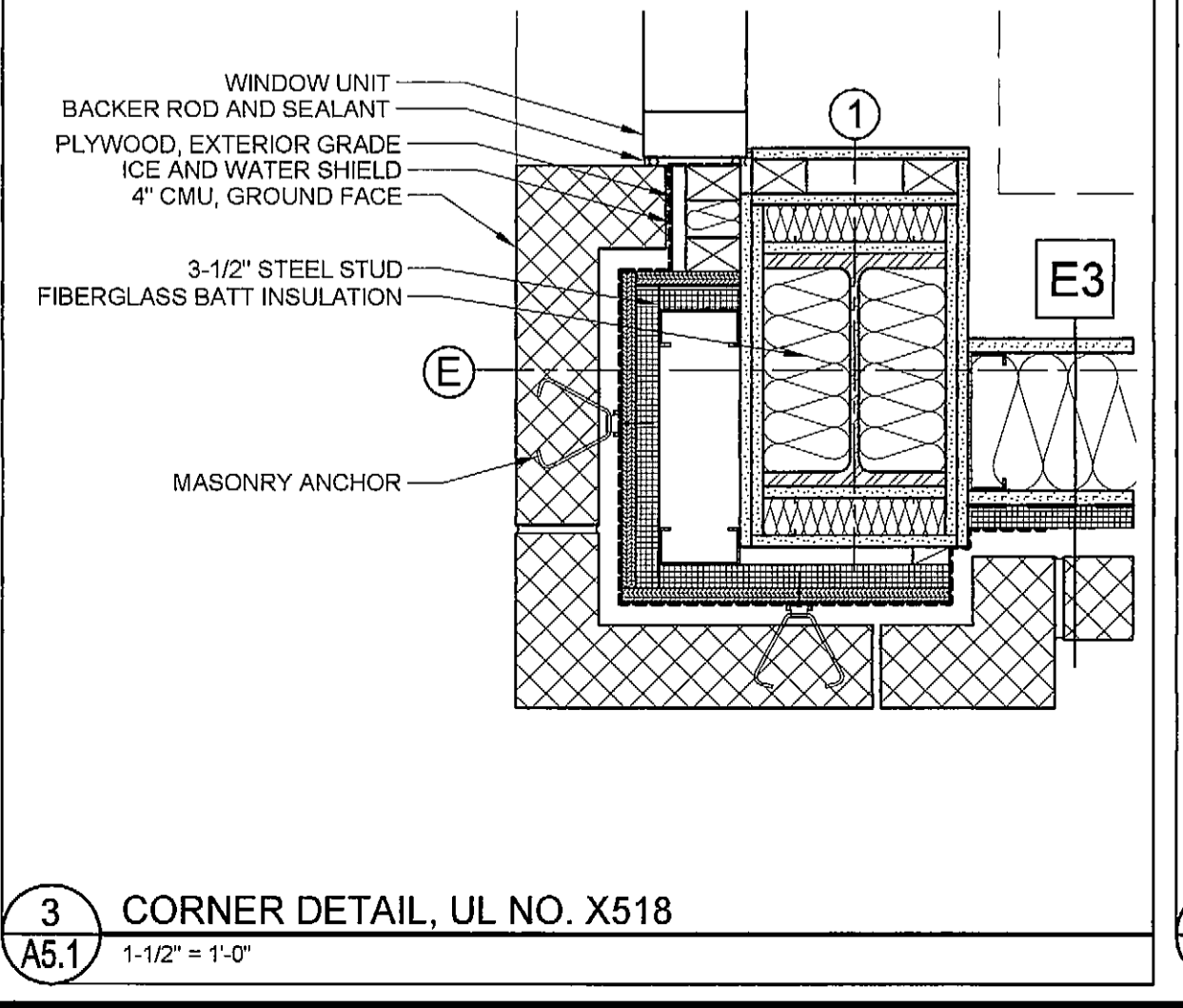
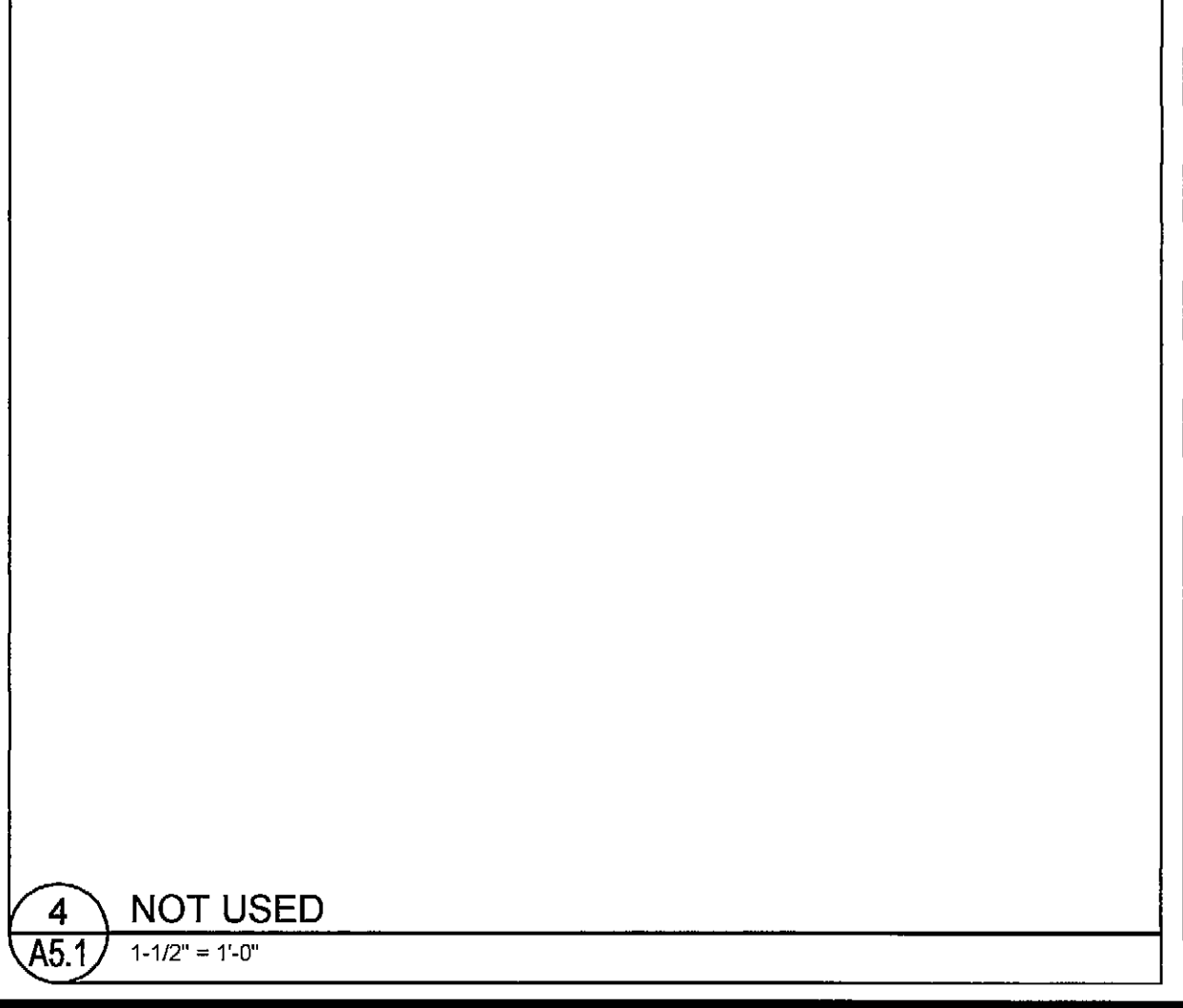
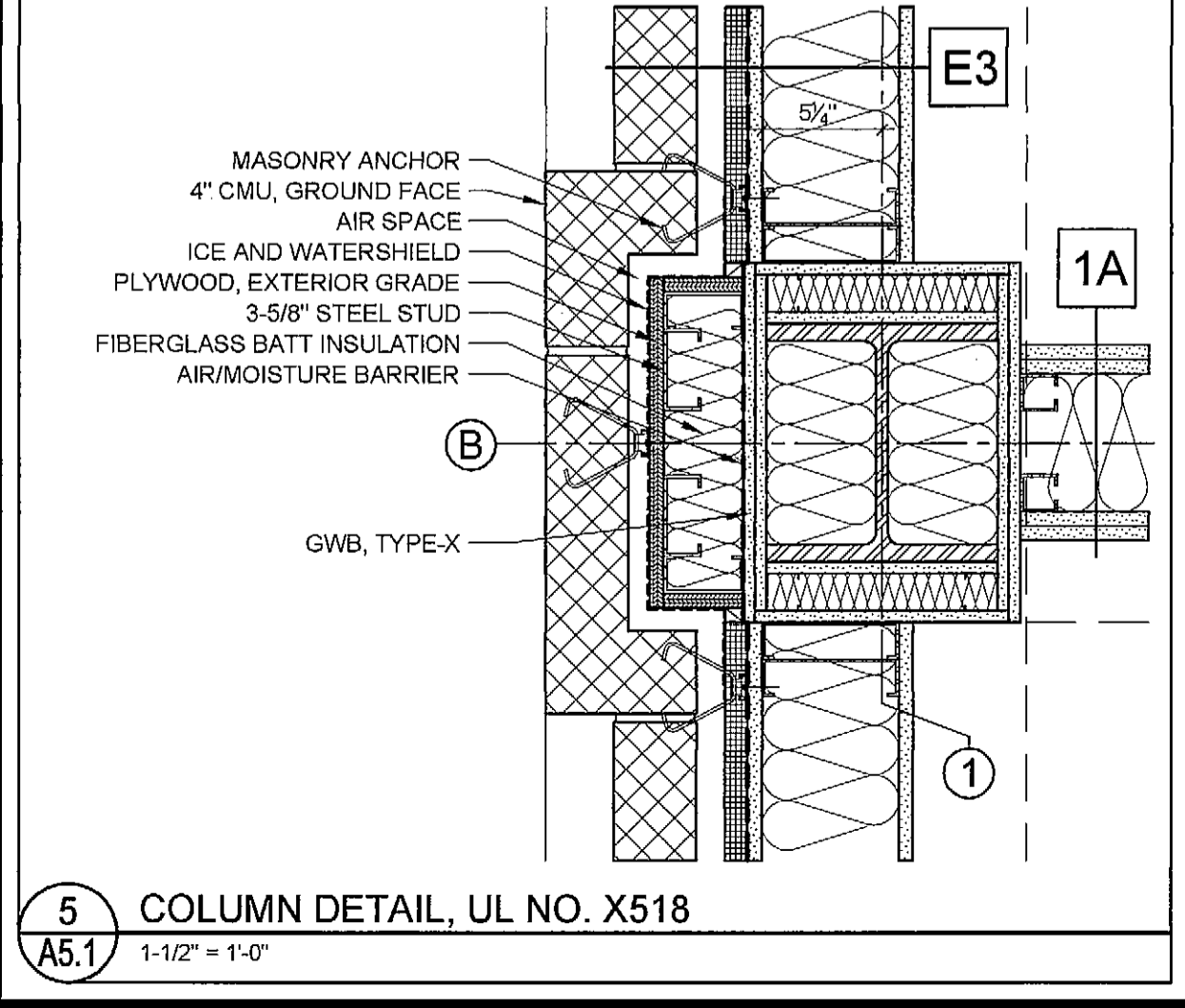
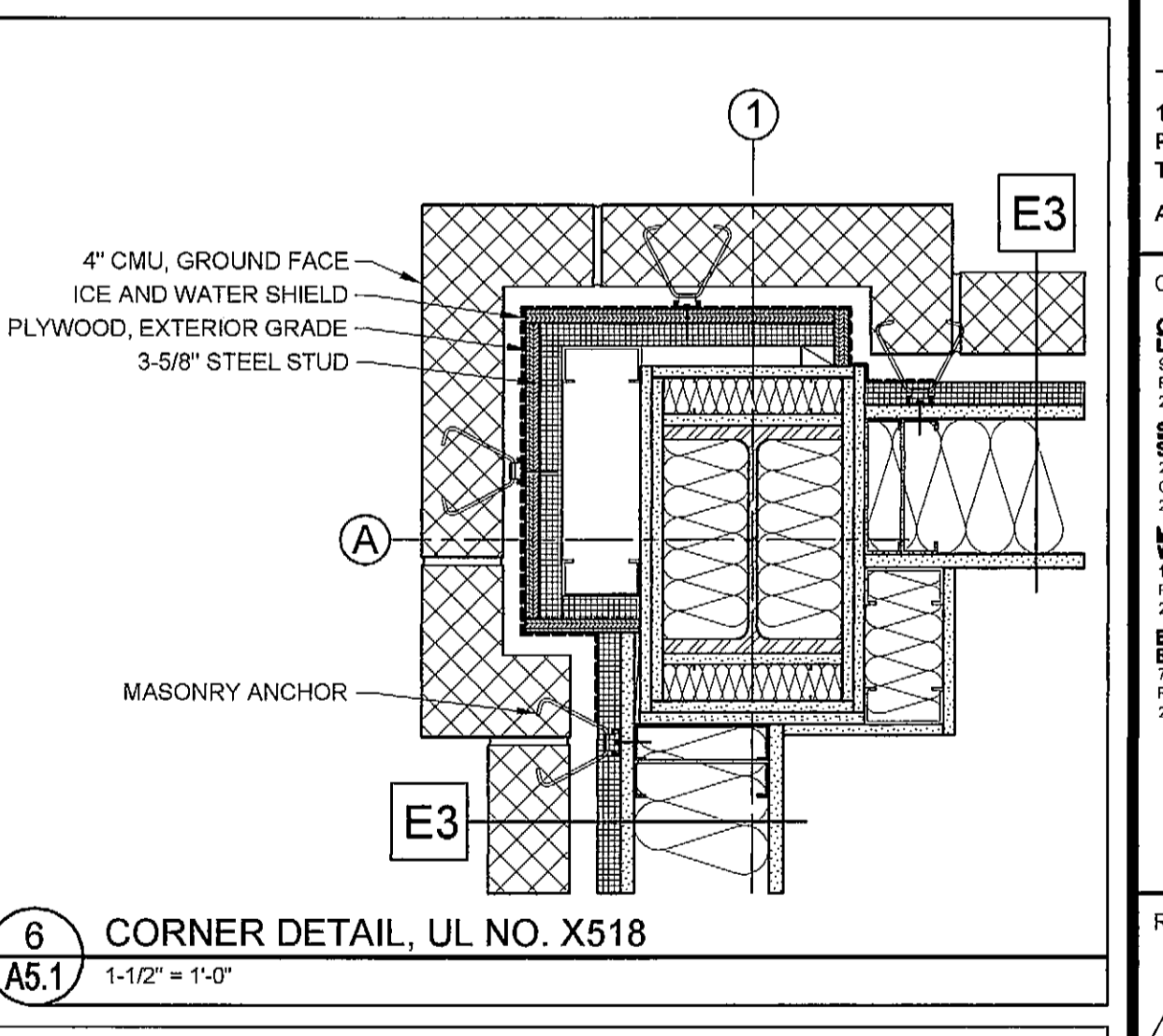
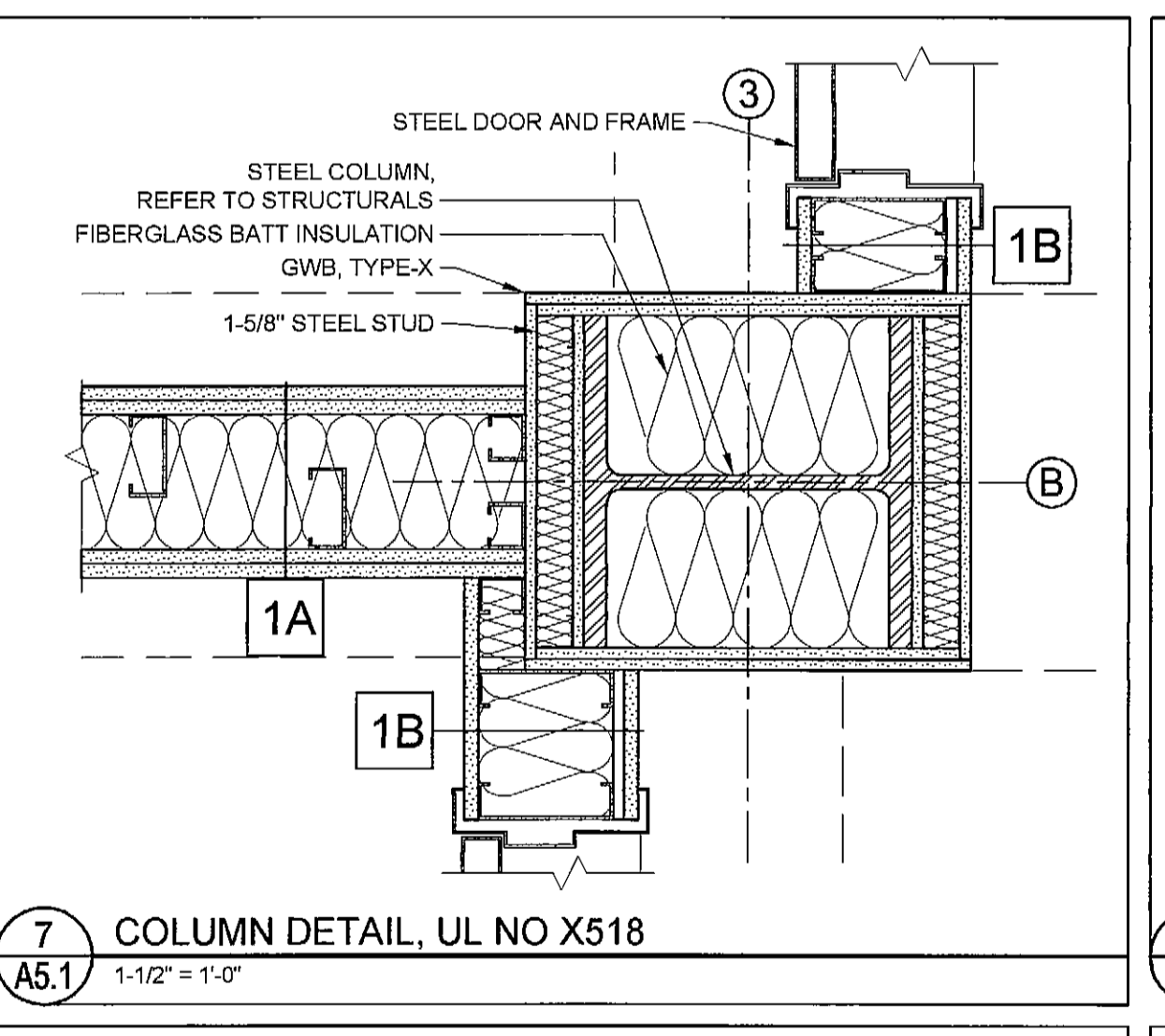
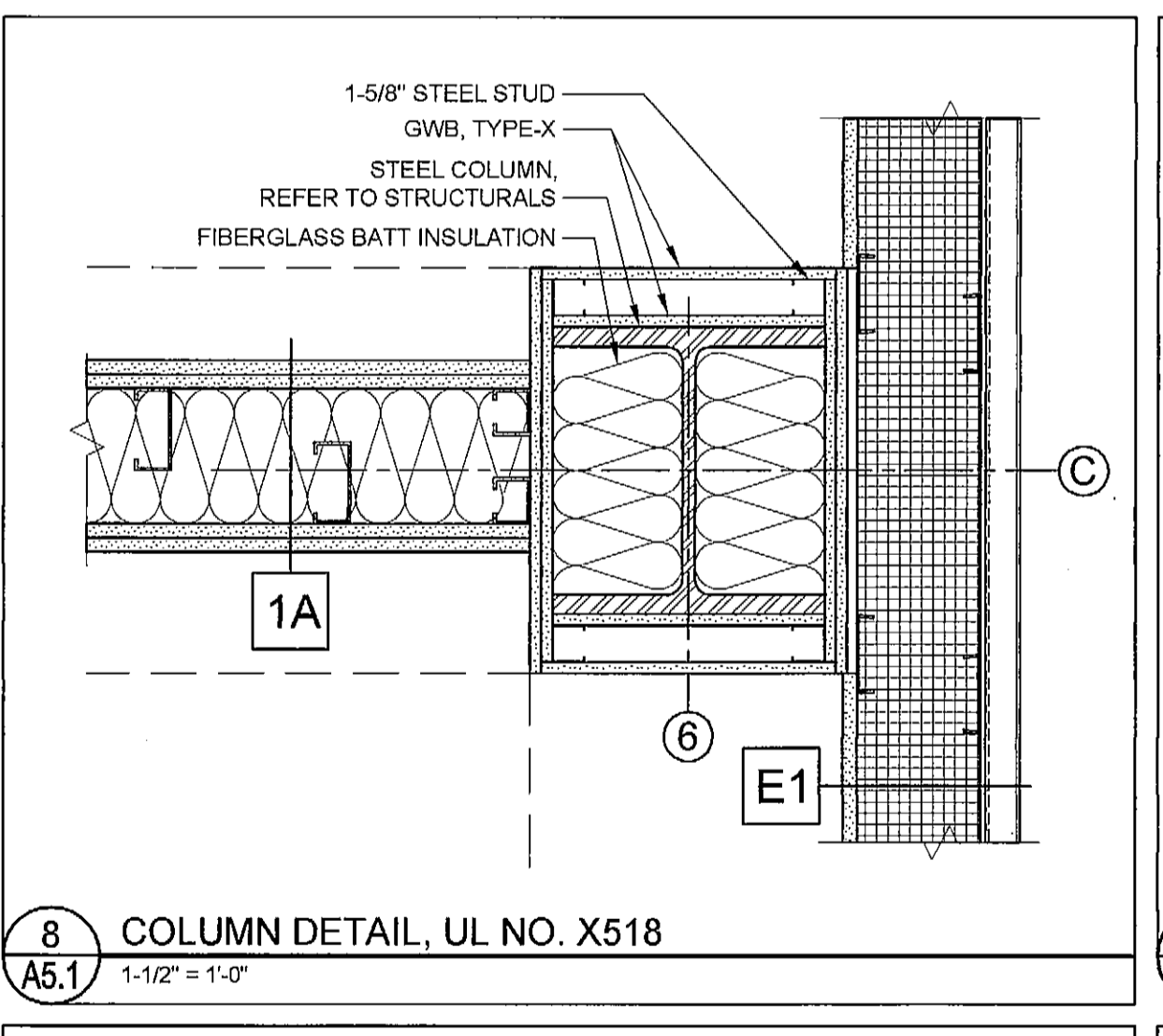
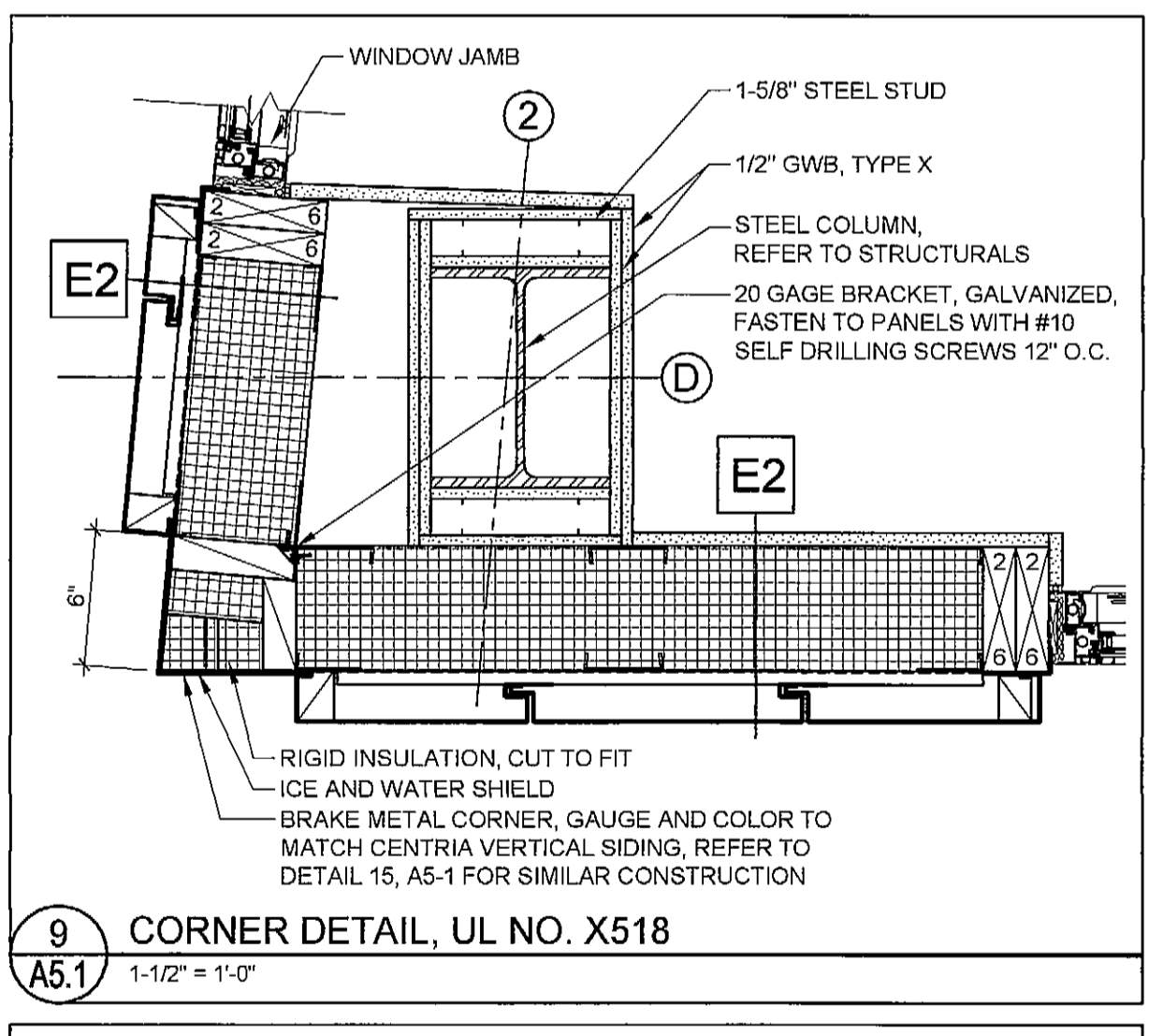
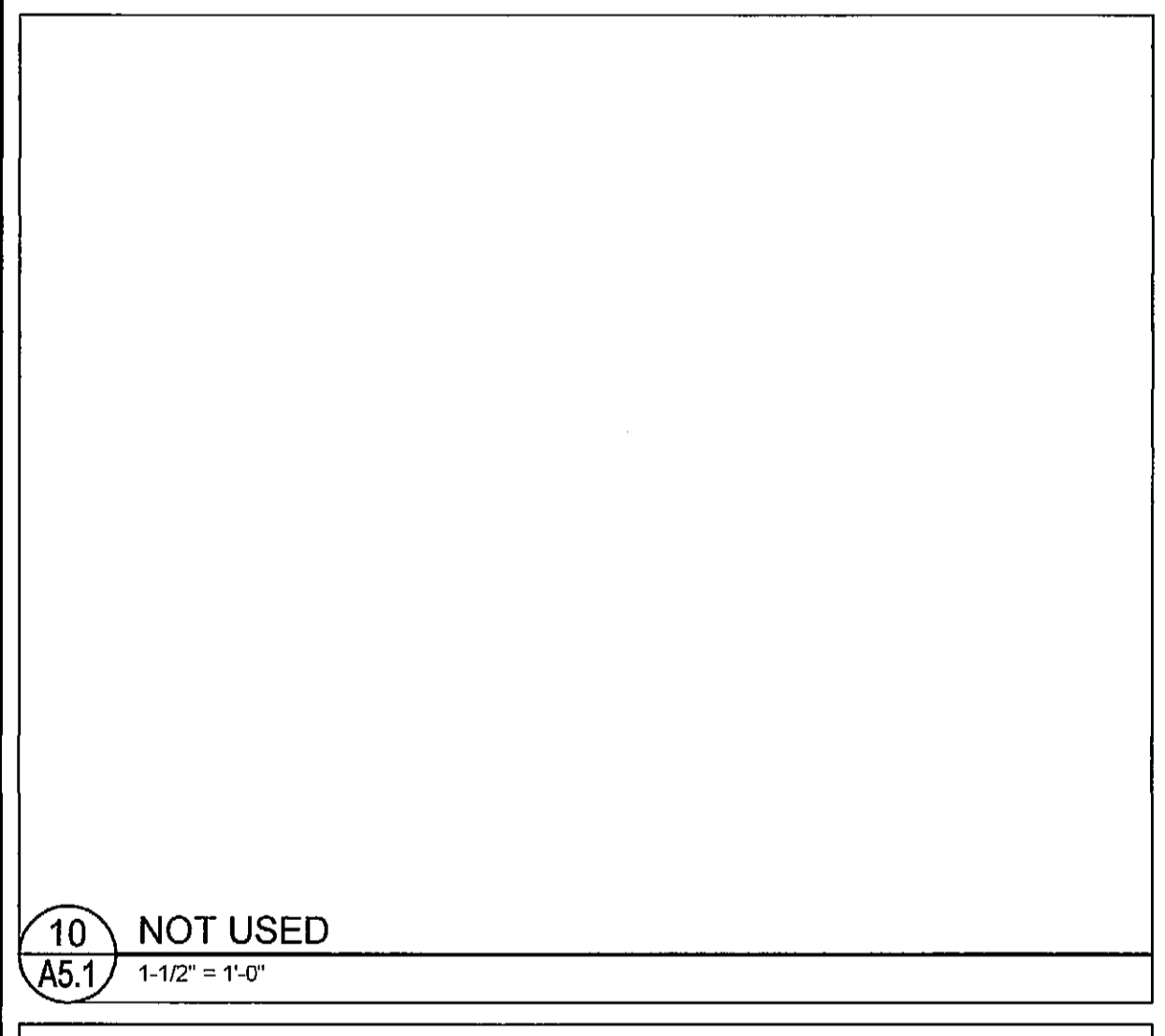
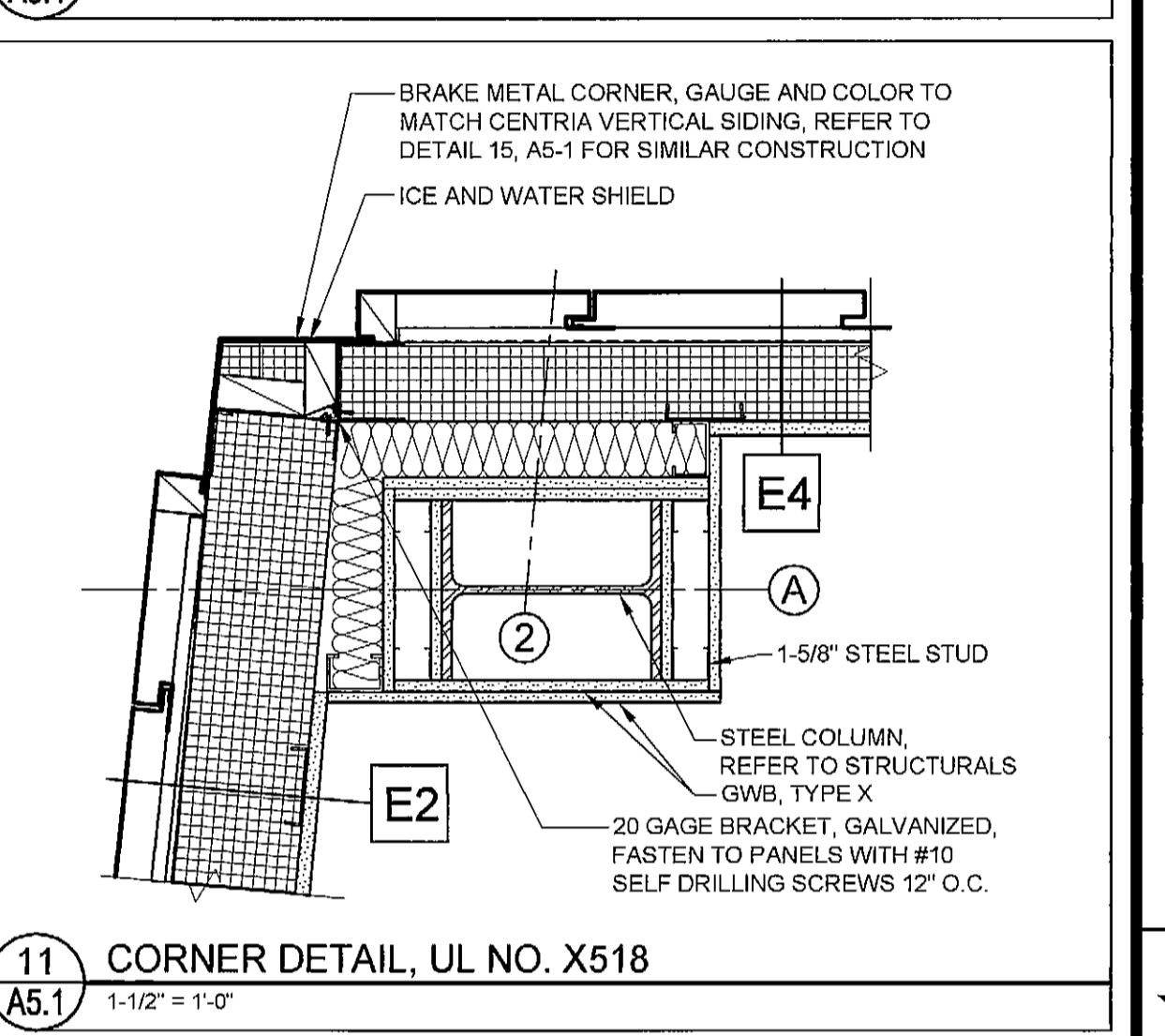
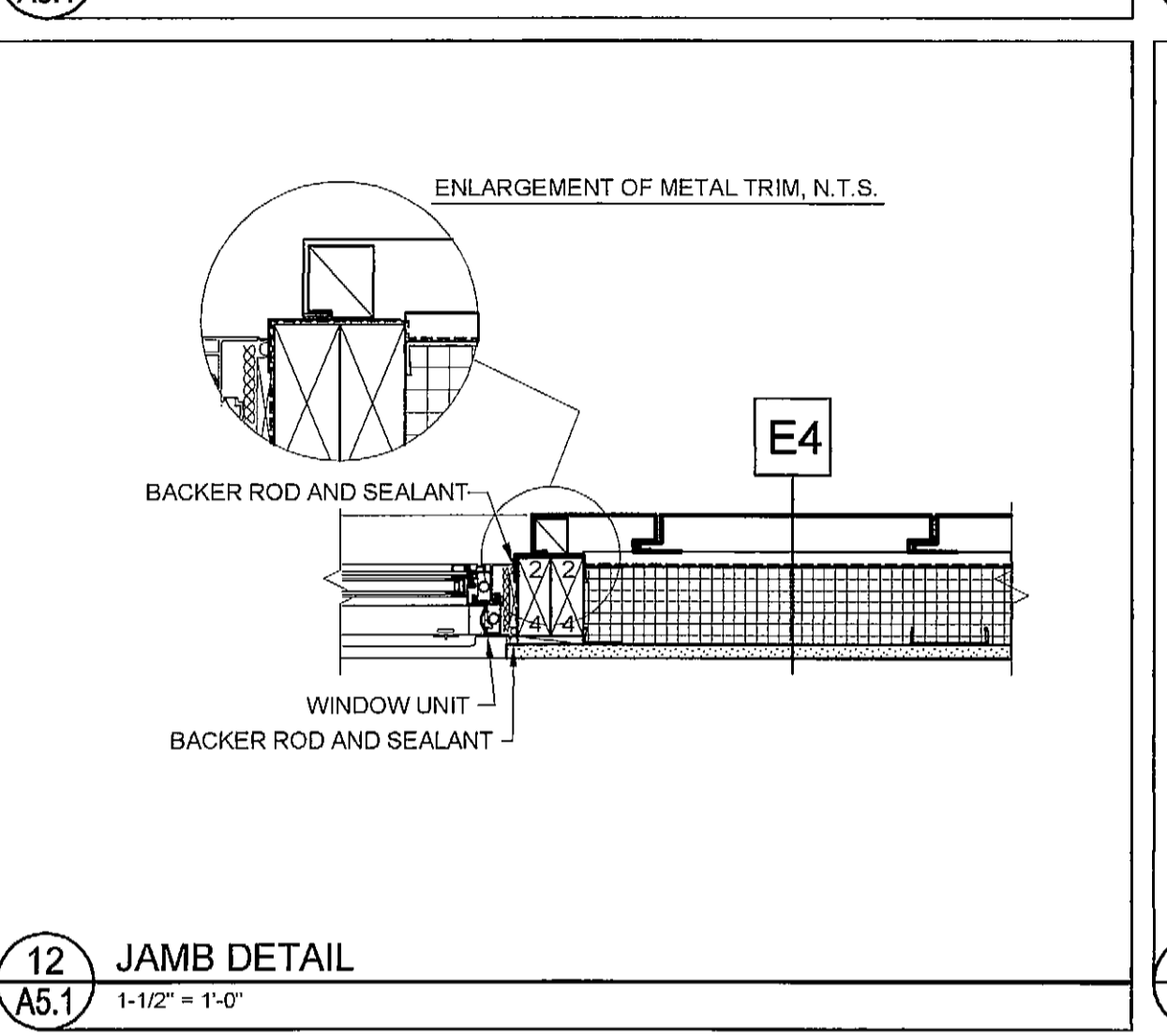
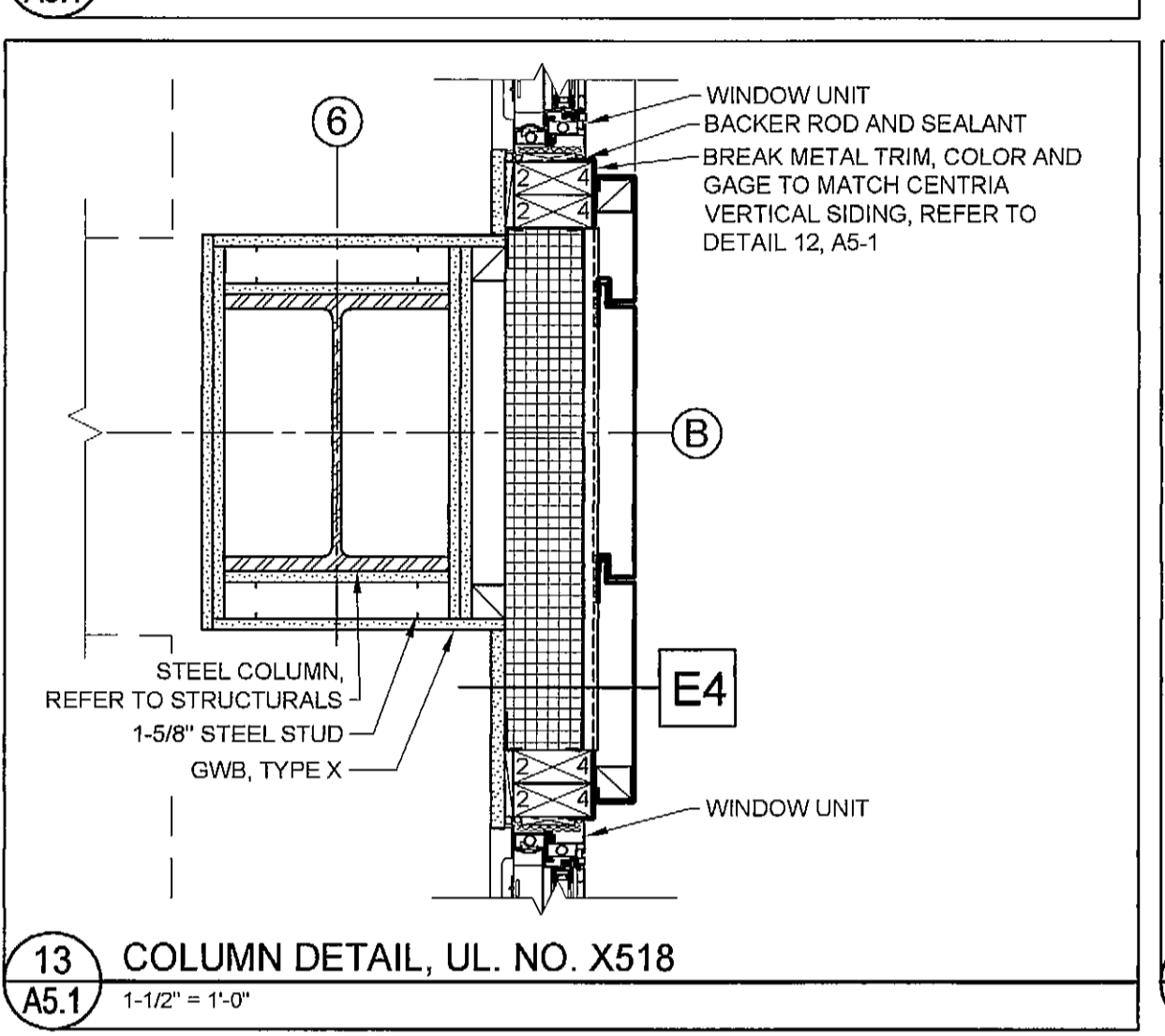
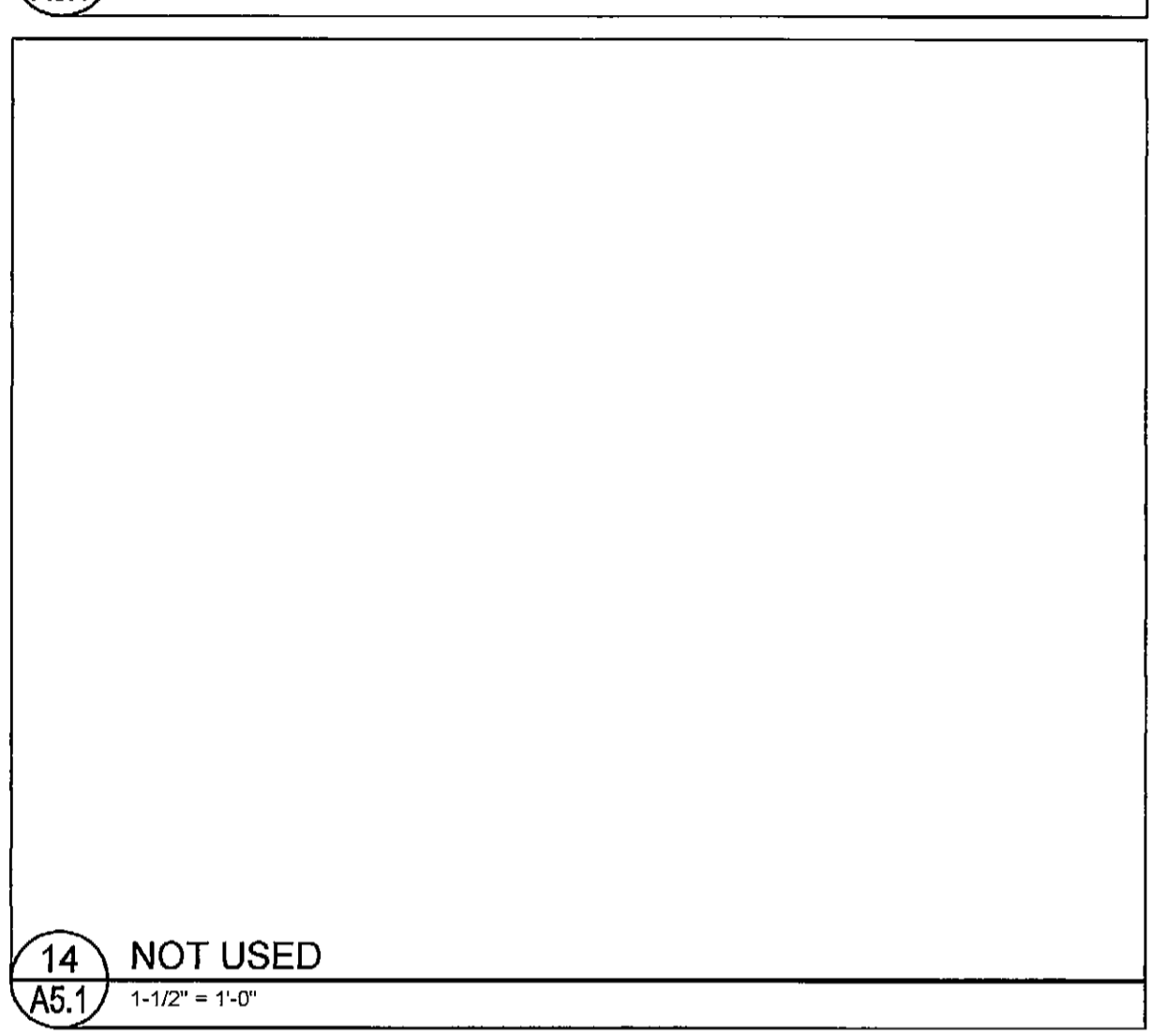
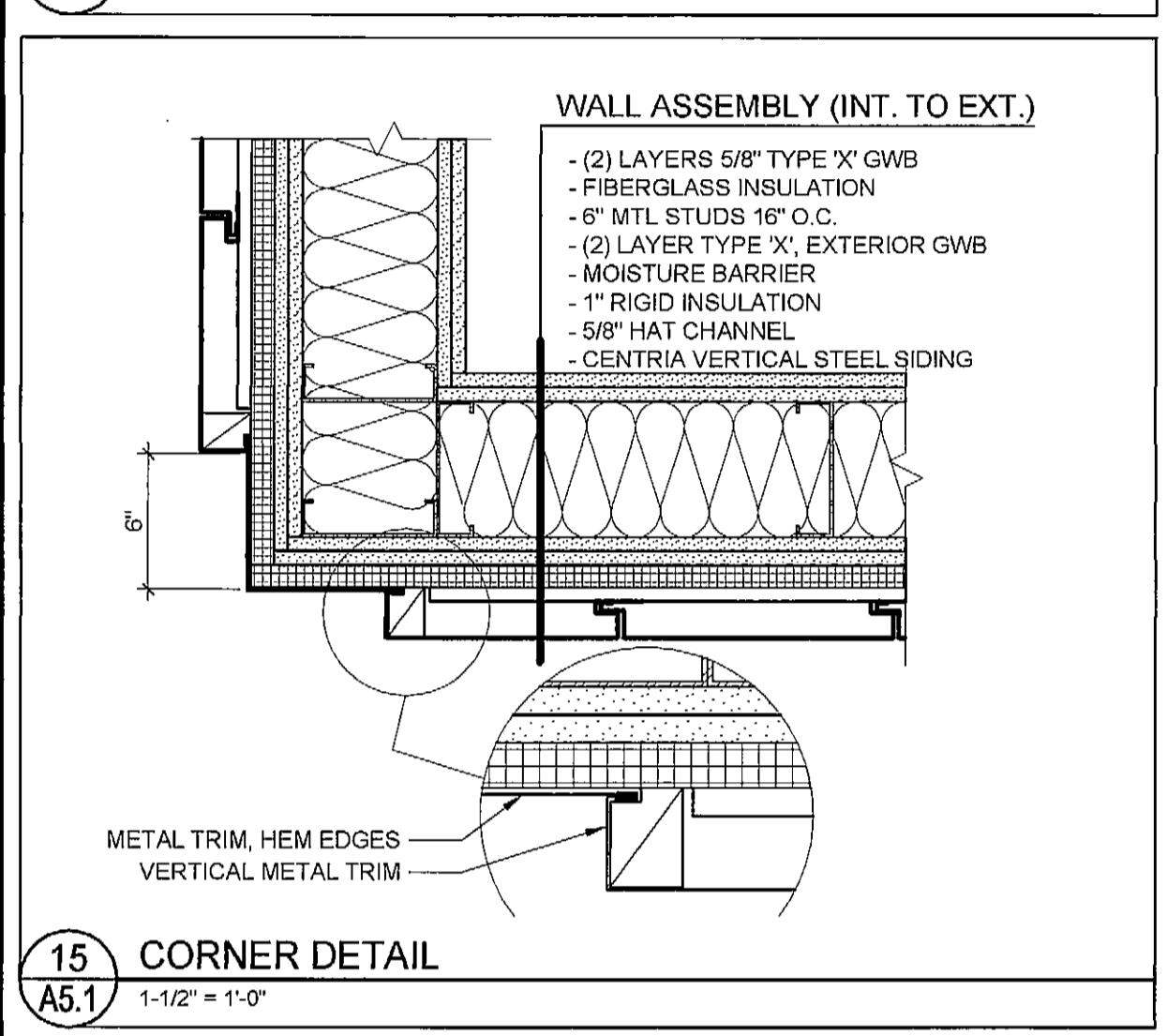
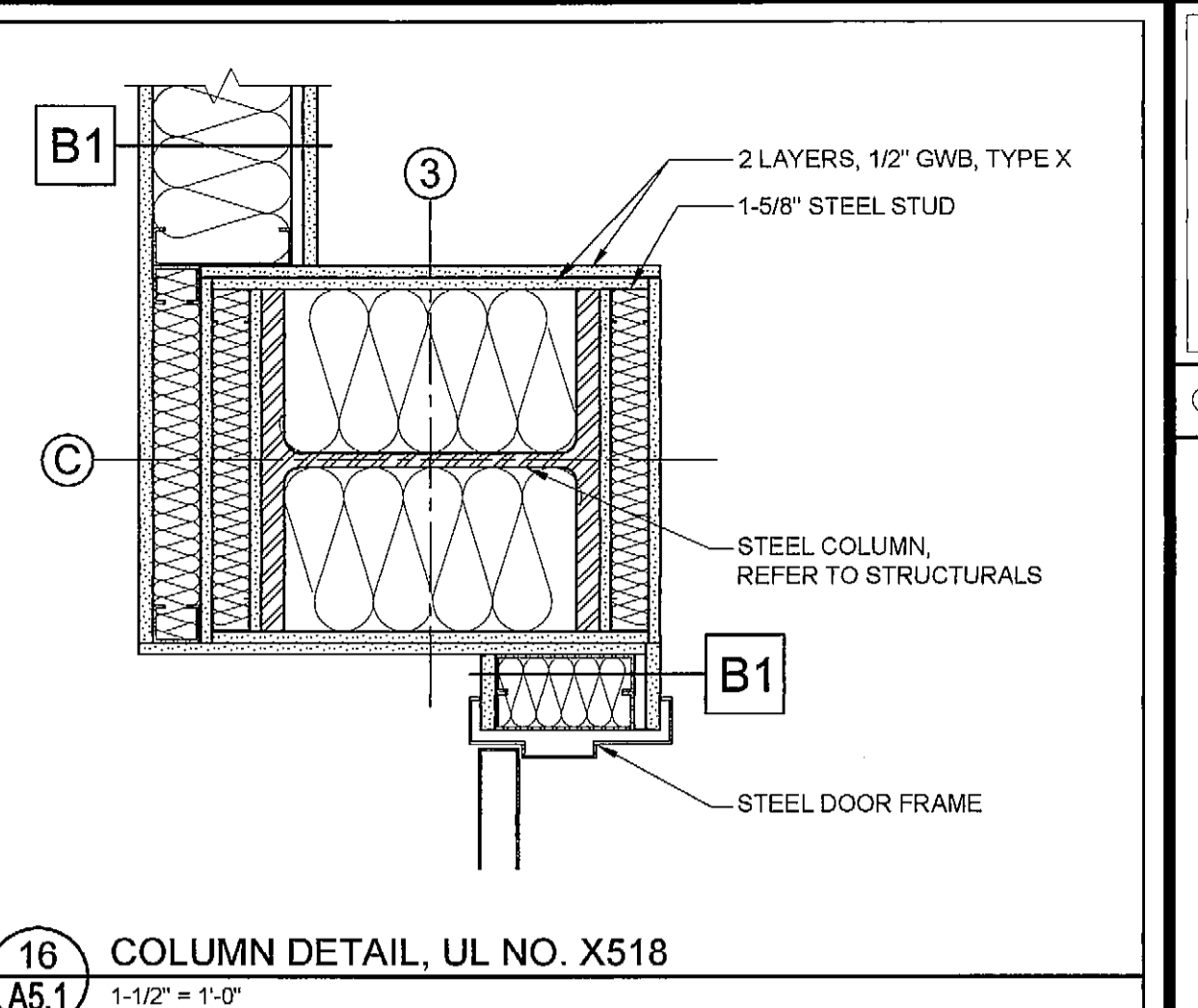
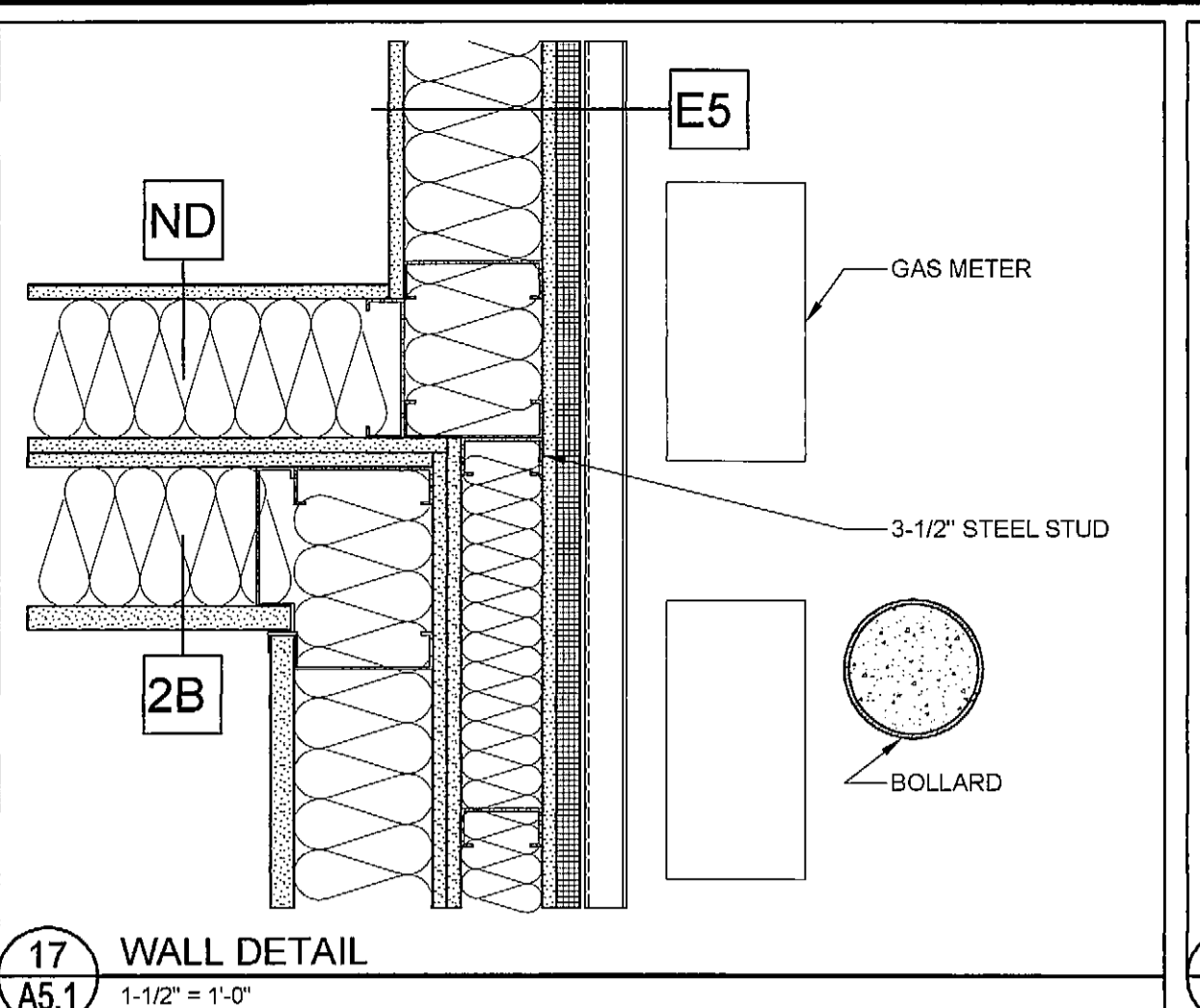
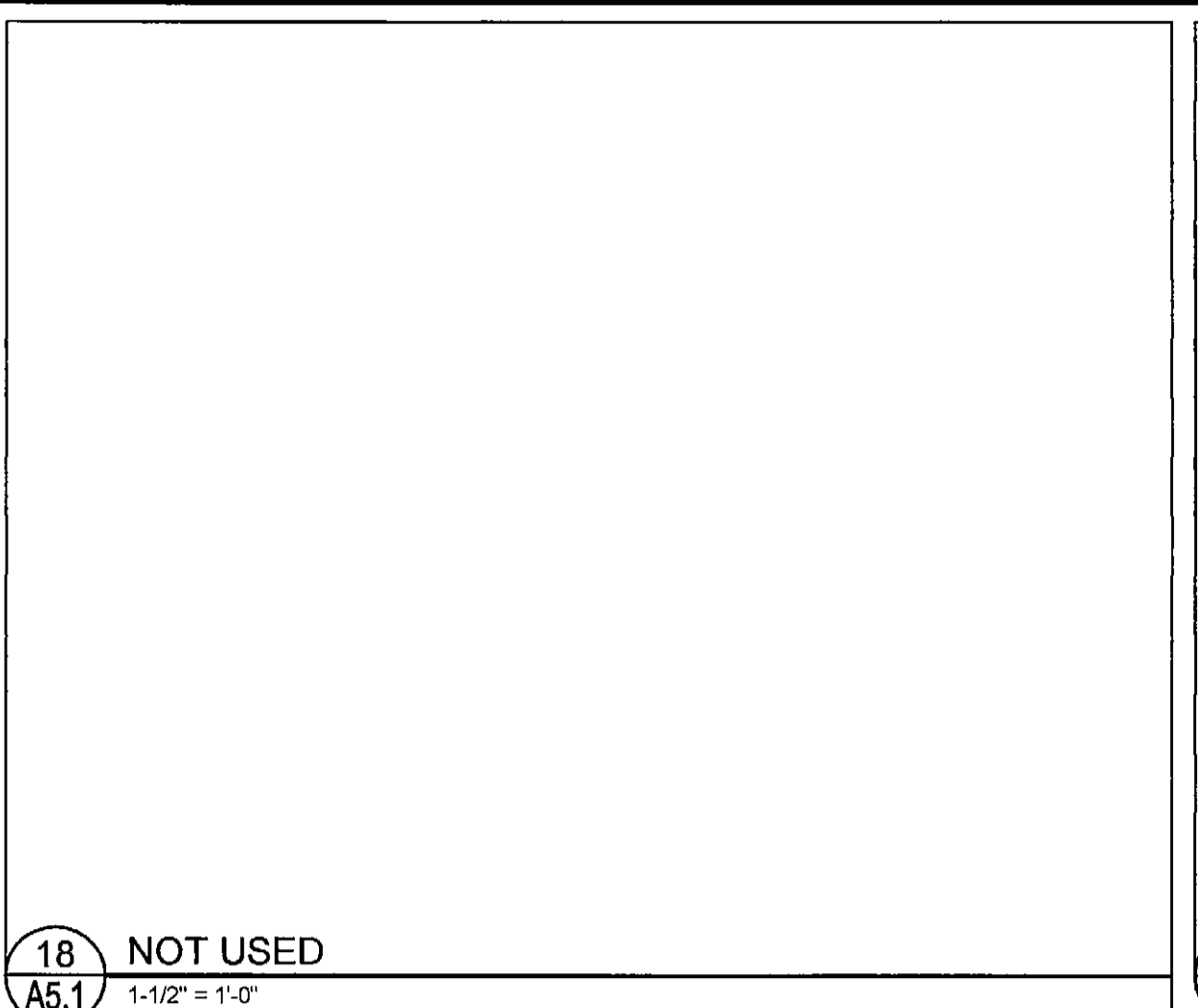
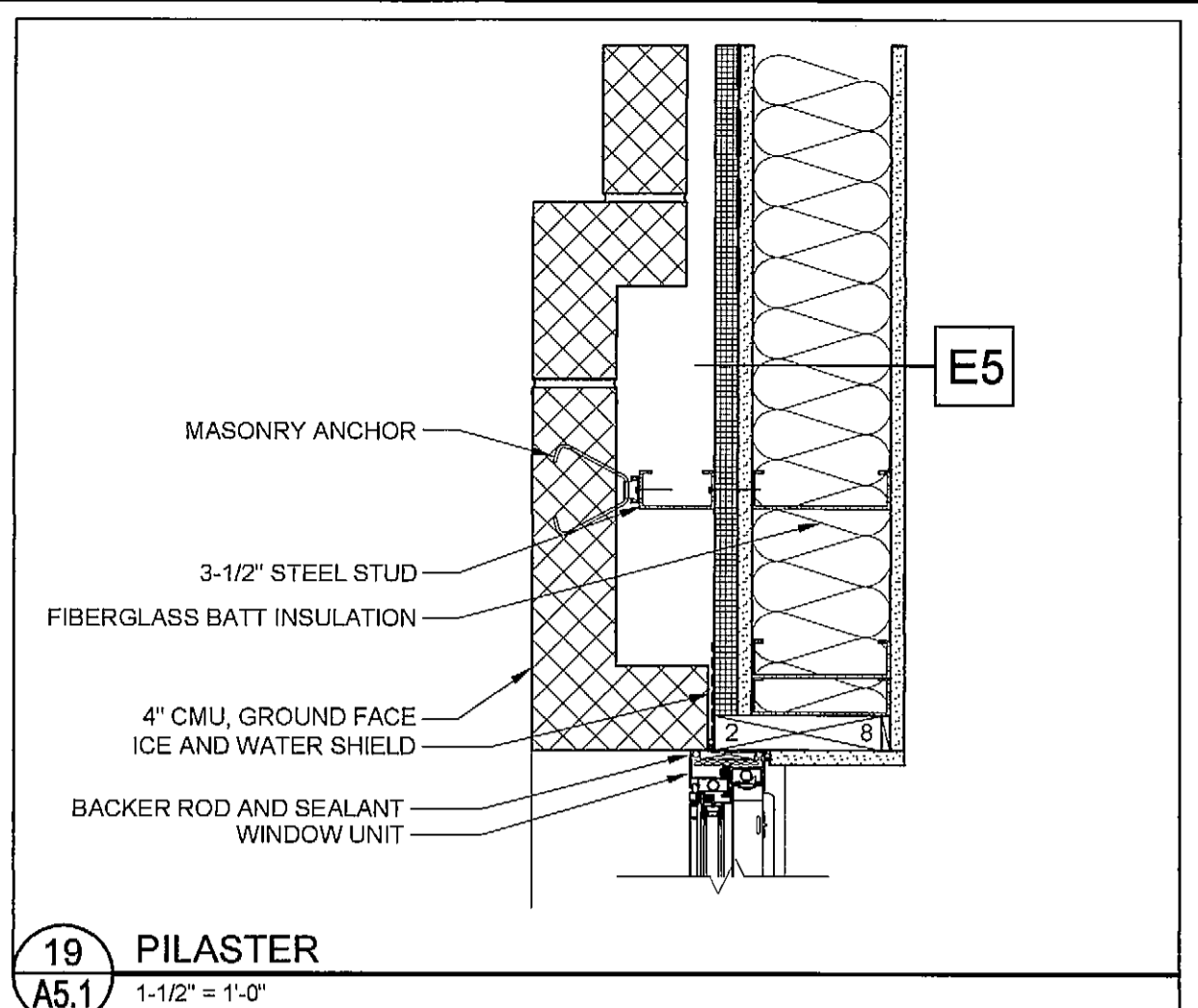
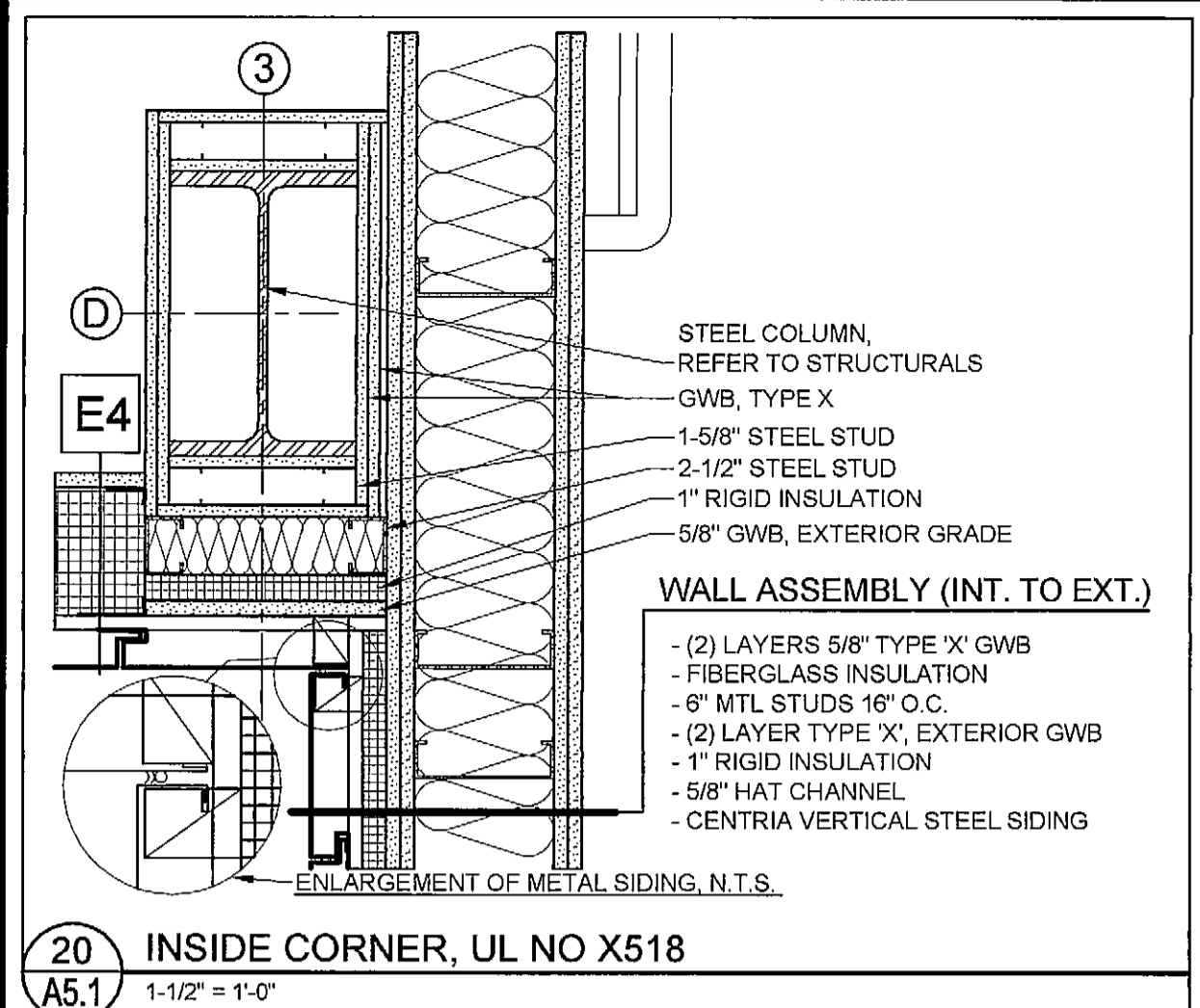
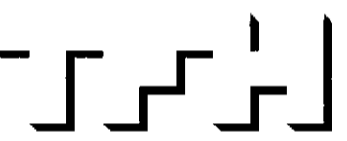

TFH ARCHITECTS
100 COMMERCIAL STREET
PORTLAND MAINE 04101
TELEPHONE 207 775 6141
ARCHITECTURE PLANNING

CONSULTANTS:

Civil:
Larf Use Consultants
950 Riverside Street
Portland, ME 04103
207-478-3313

Structural:
Structural Design Consulting
25 Oakmont Drive
Oak Orchard Beach, ME 04054
207-934-8028

Mechanical:
Wintery Engineering
10 Danforth Street
Portland, ME 04101
207-874-7449

Electrical:
Bennett Engineering
7 Bennett Road
Fryeburg, ME 04032
207-869-8475

REVISIONS:

100% CONSTRUCTION DOCUMENTS
22.24.08

DATE:
PROJECT No. 0422
DRAWN BY: CSC
CHECKED BY: TST
SCALE: AS NOTED

SHEET TITLE:
PLAN DETAILS

A5.1