

1 BATHROOM TYPE "A"
 SCALE: 1/2" = 1'-0"

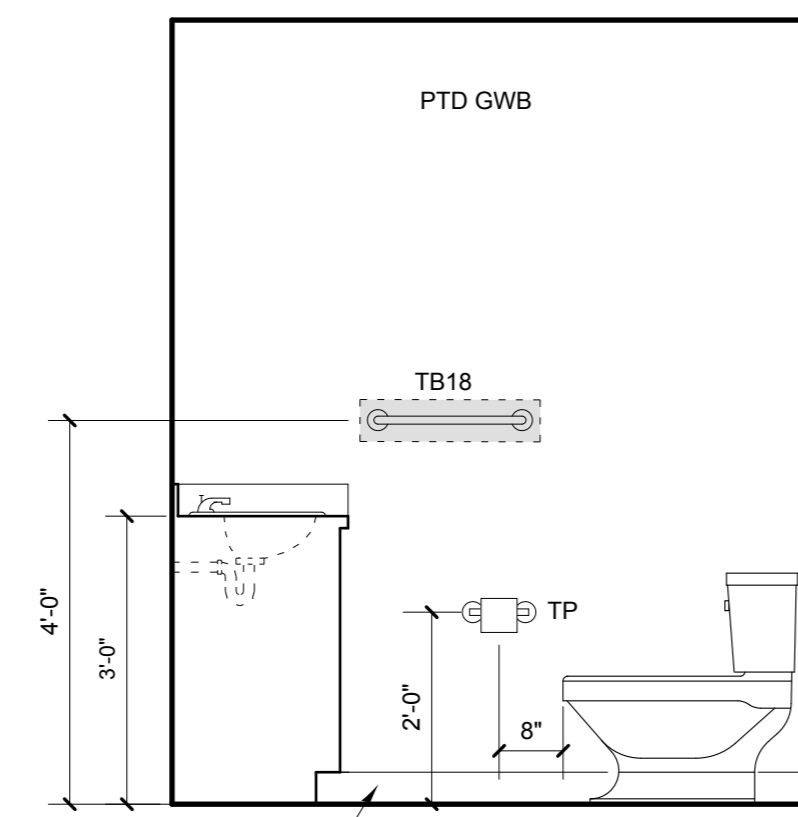

1
1

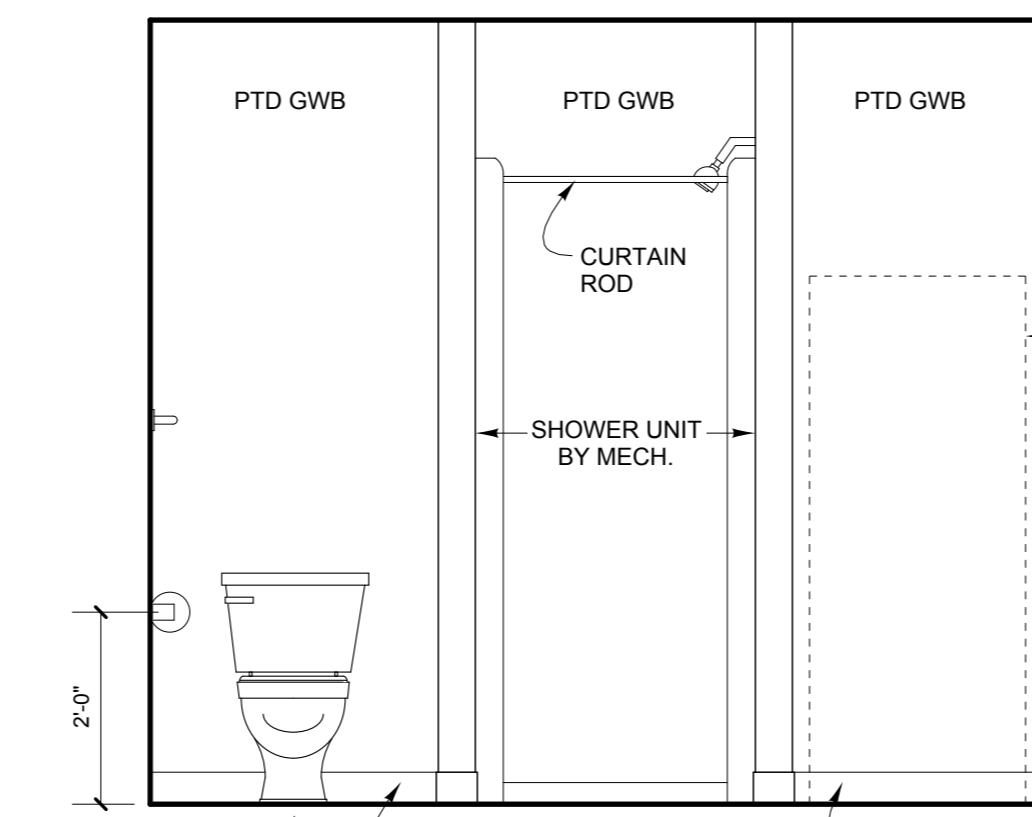

2
1

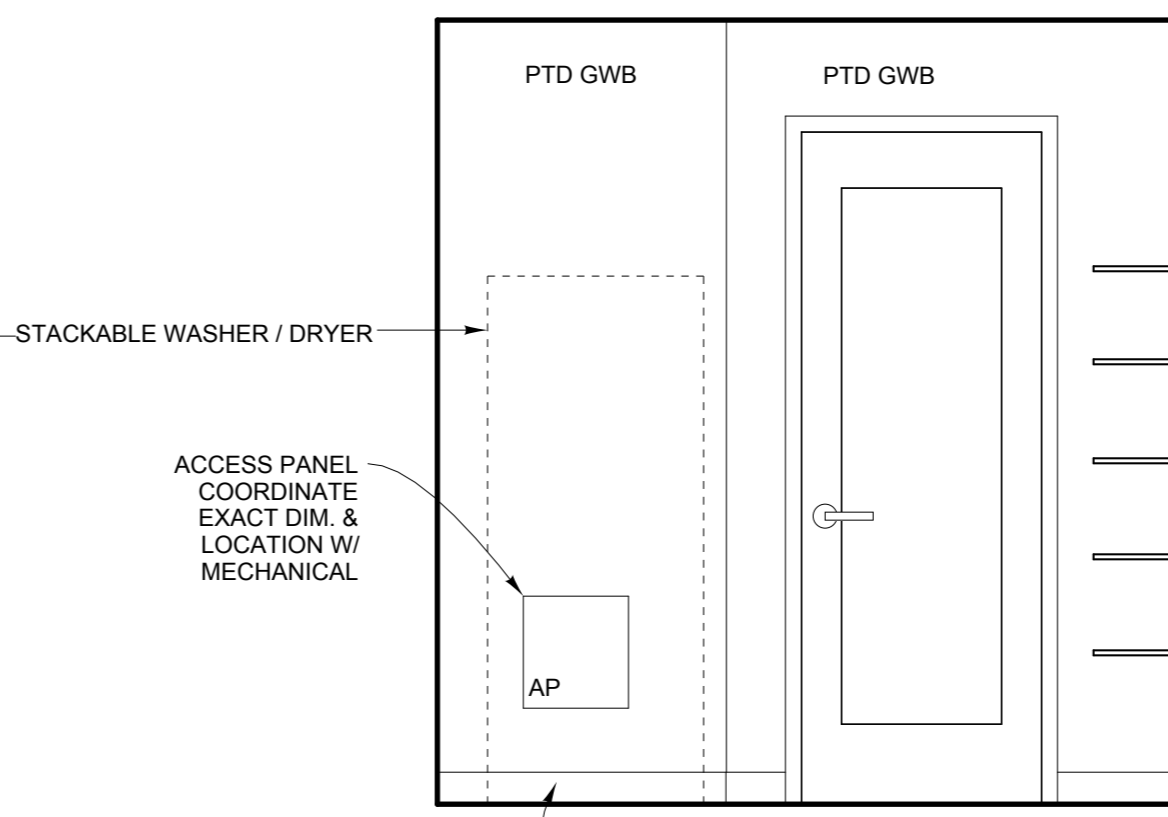

3
1

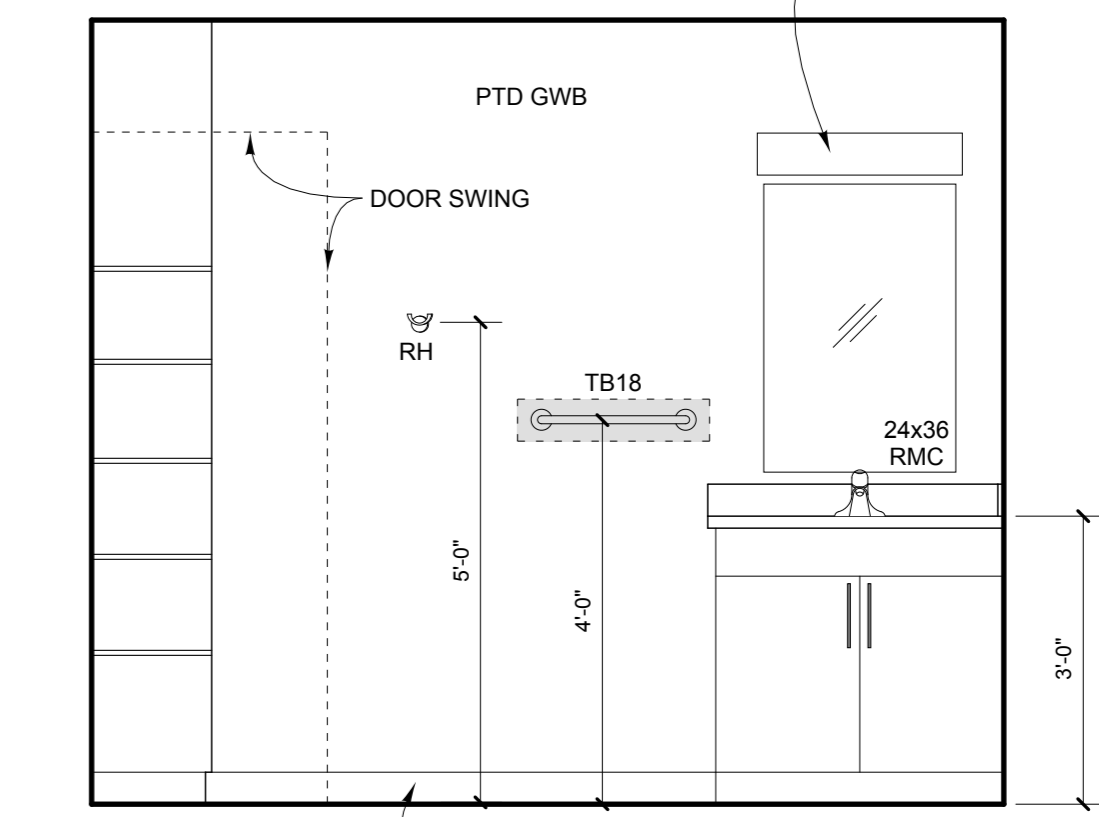

4
1

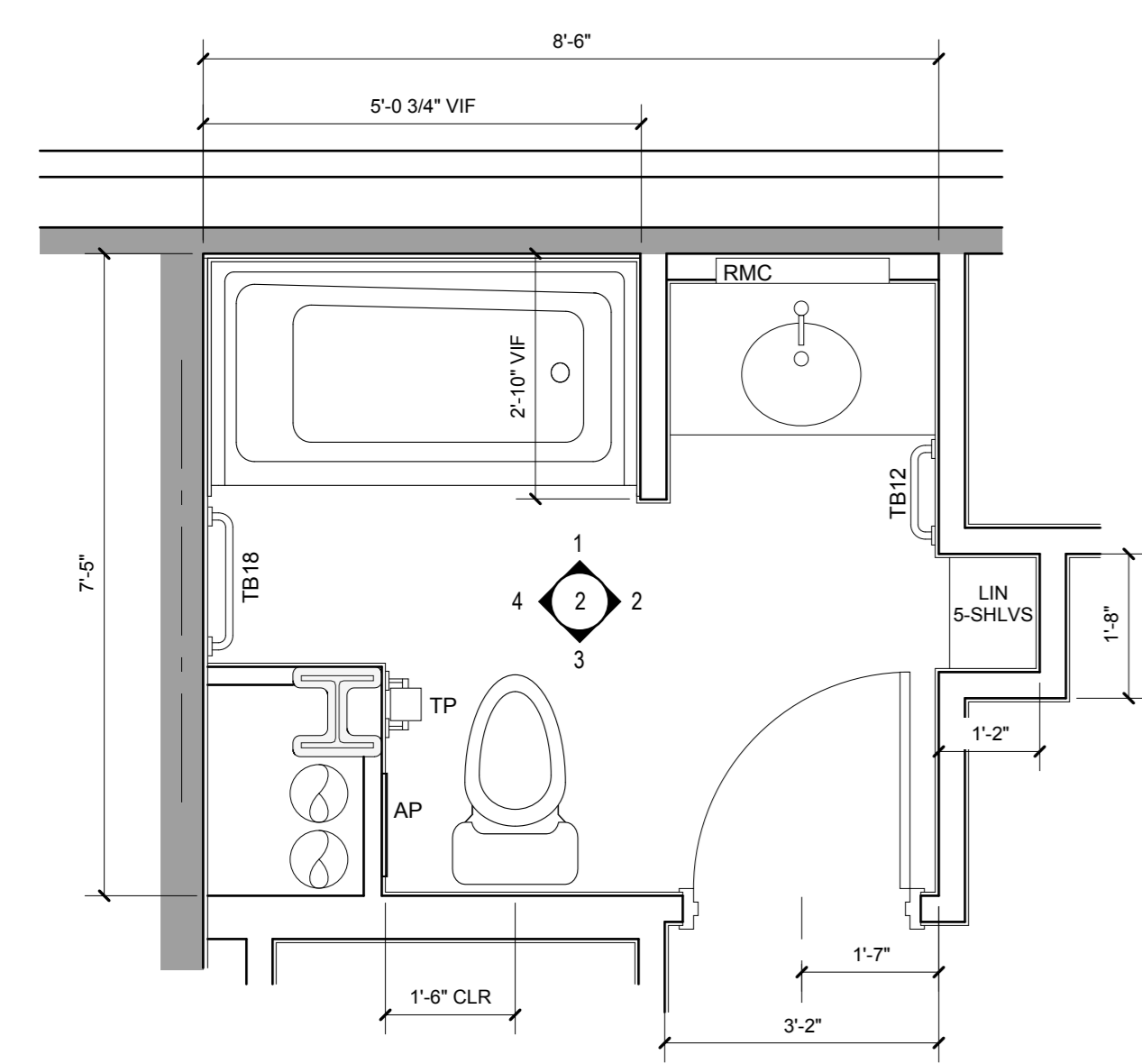

2 BATHROOM TYPE "B"
 SCALE: 1/2" = 1'-0"

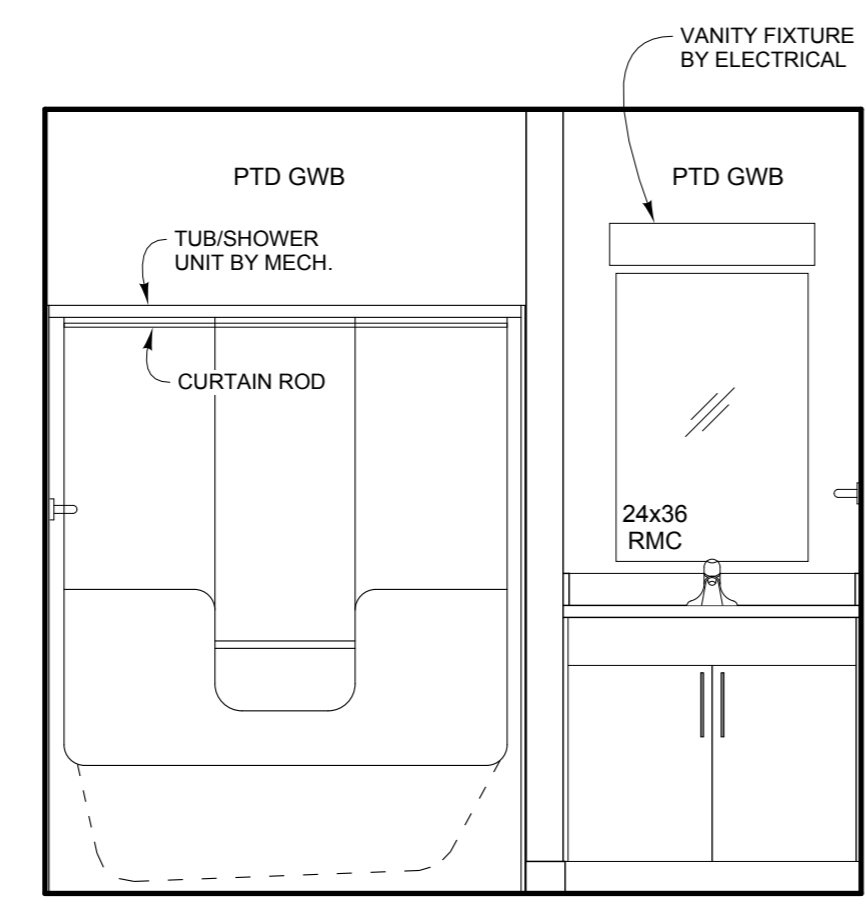

1
2

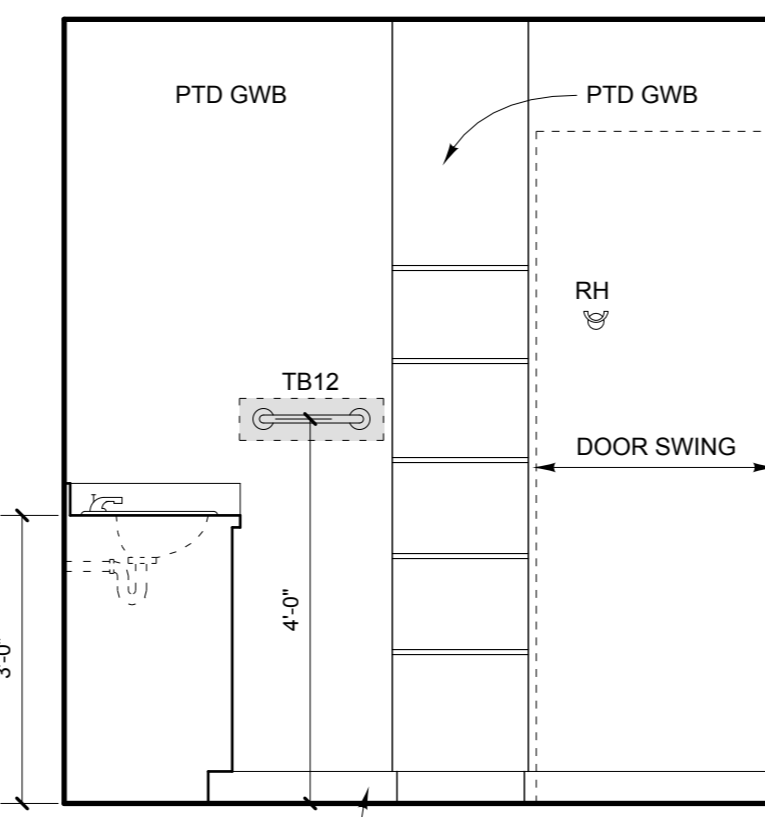

2
2

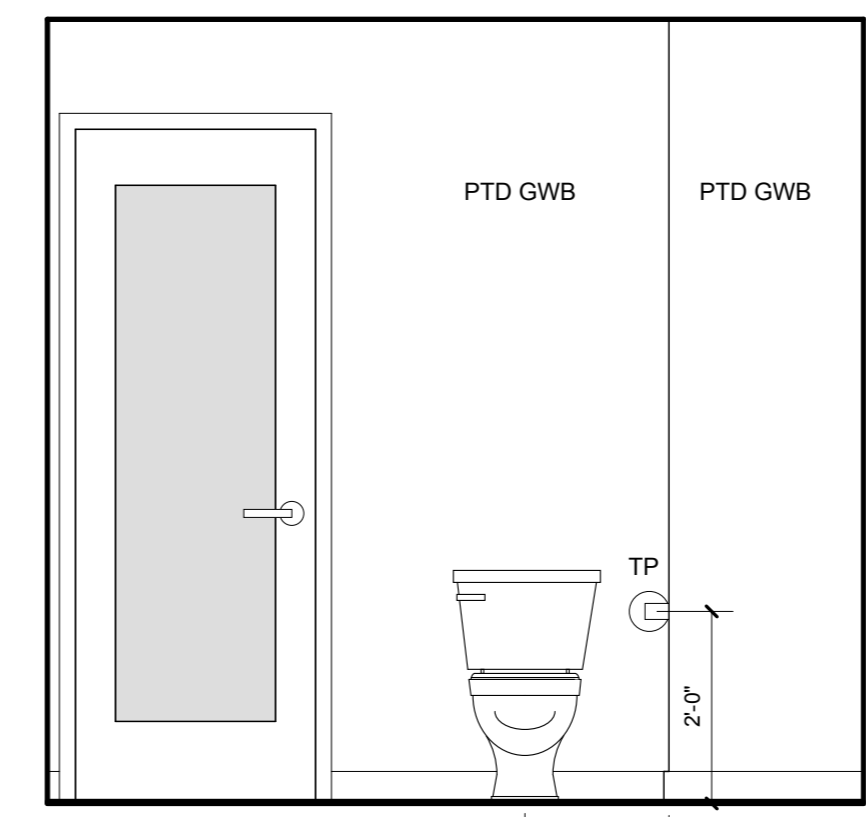

3
2

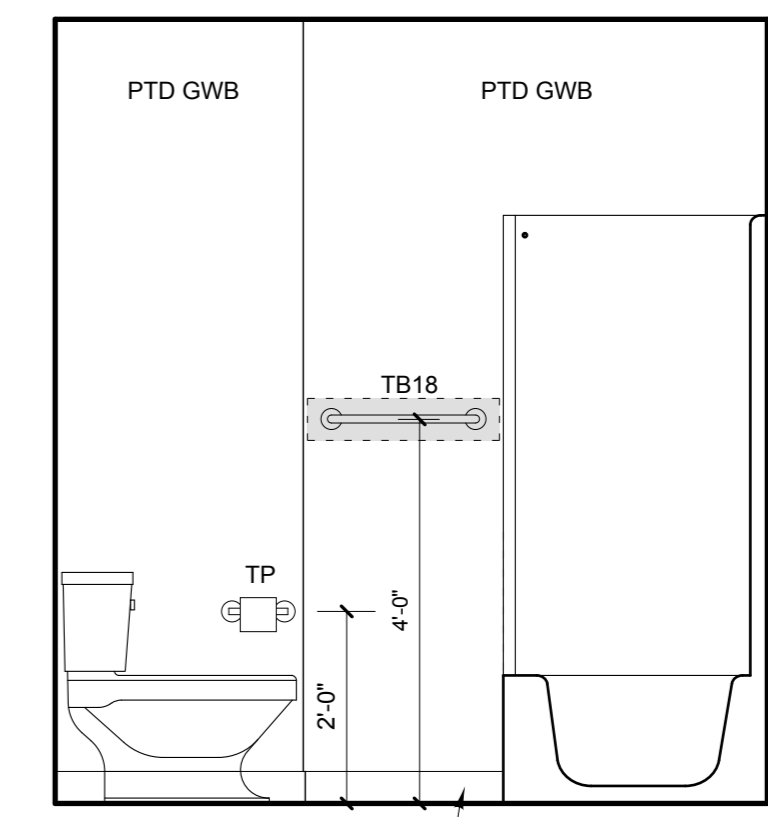

4
2

ISSUED FOR BUILDING
 PERMIT ONLY
 03/30/16

Structural Engineer
 Structural Integrity
 Consulting Engineers, Inc.

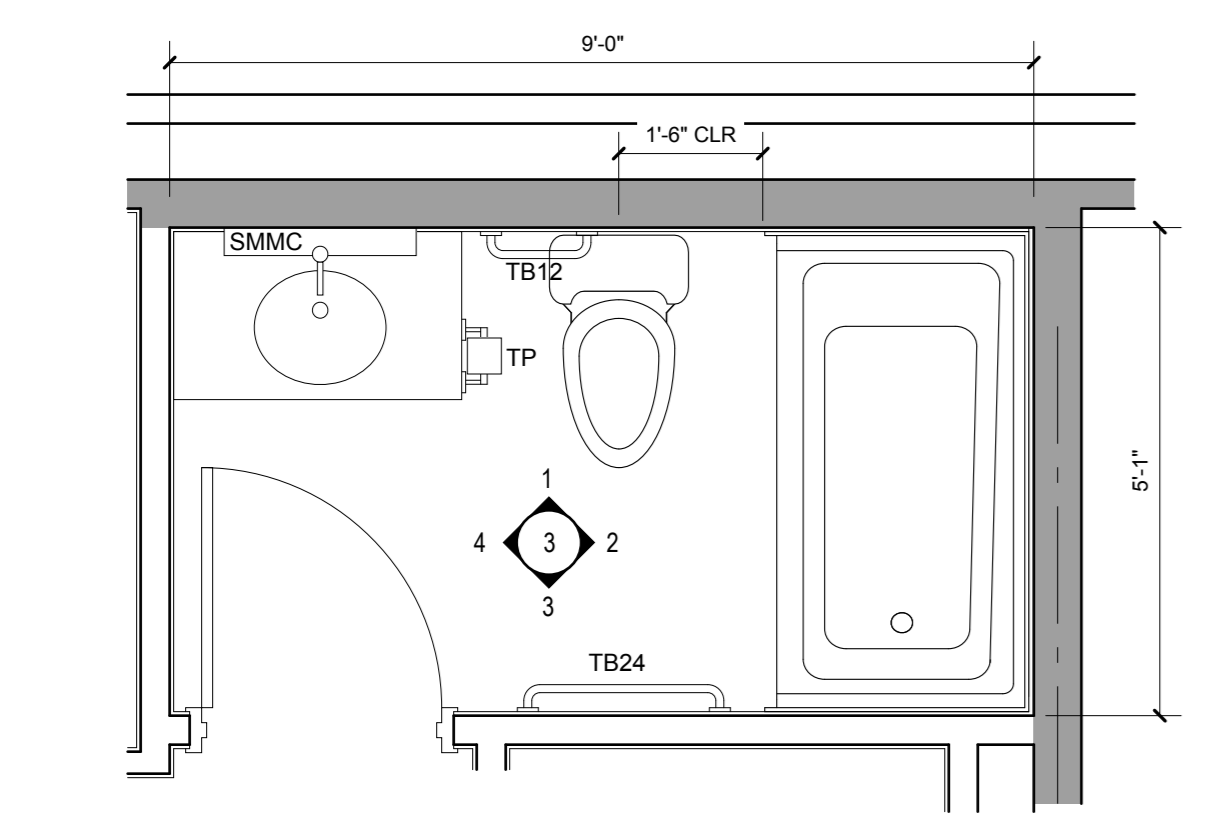

3 BATHROOM TYPE "C"
 SCALE: 1/2" = 1'-0"

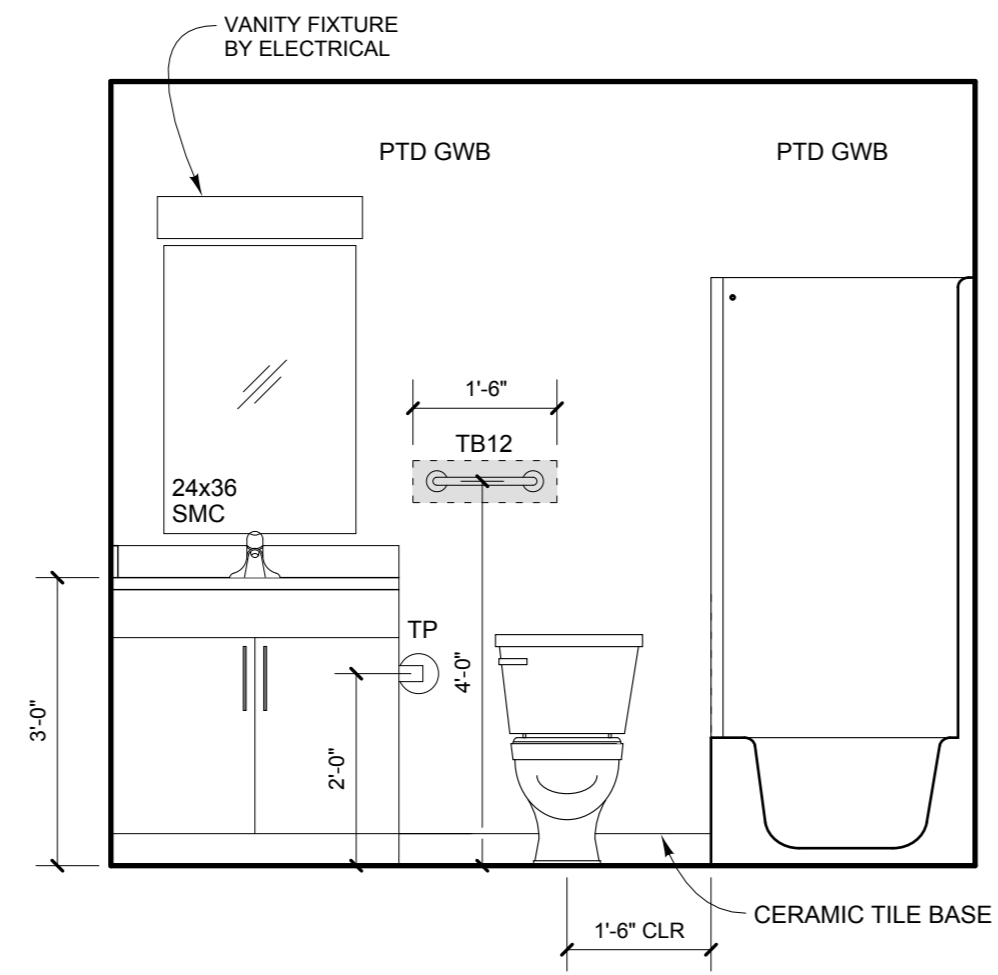

1
3

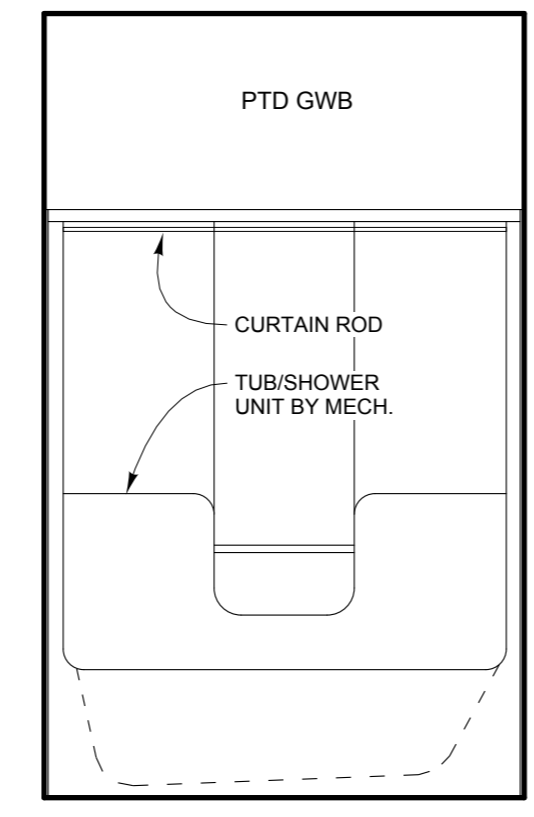

2
3

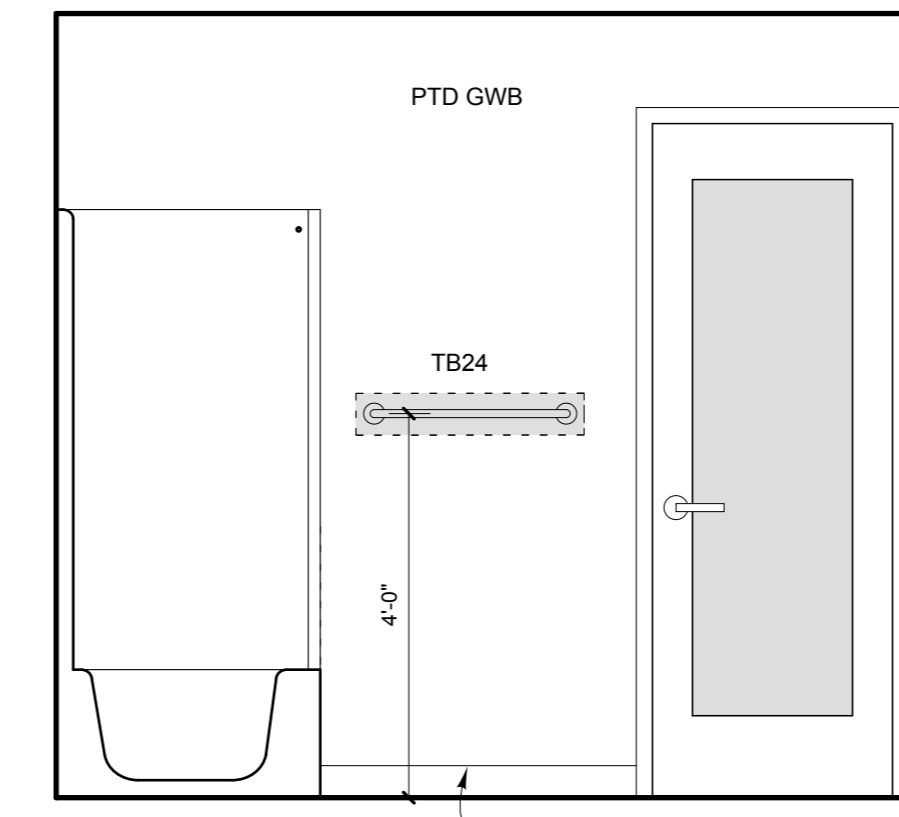

3
3

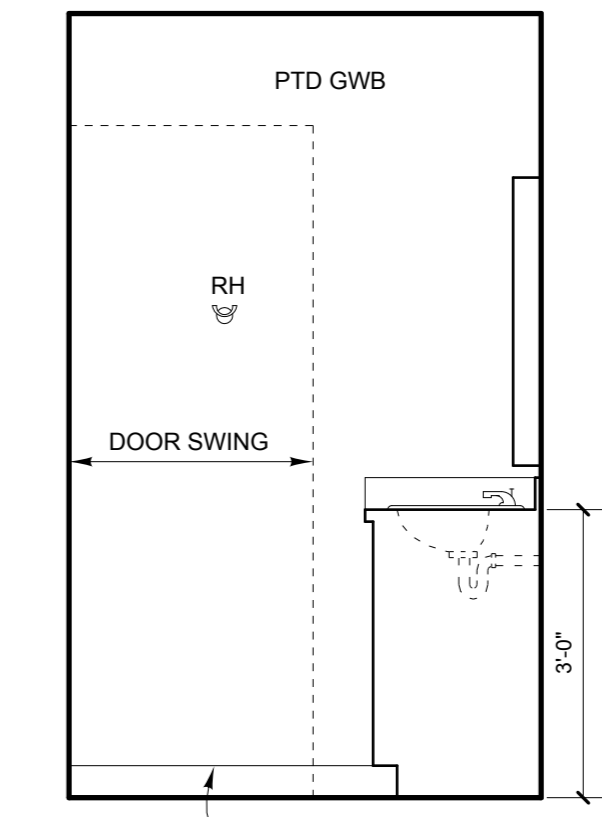

4
3

LEGEND		SEE SPECIFICATIONS FOR TOILET ACCESSORIES
TP	TOILET PAPER DISPENSER	
TB24	24" TOWEL BAR	
TB12	12" TOWEL BAR	
RH	ROBE HOOK	
GB24	24" GRAB BAR	
GB36	36" GRAB BAR	
GB42	42" GRAB BAR	
GB48	48" GRAB BAR	
RMC	RECESSED MEDICINE CABINET	
SMC	SURFACE MOUNTED MEDICINE CABINET	

GENERAL NOTES	
1	PROVIDE SOLID BLOCKING BEHIND ALL WALL MOUNTED ACCESSORIES AND AT BASE & UPPER CABINETS PER MANUFACTURER RECOMMENDATIONS
2	CABINET NUMBERS ARE BASED ON ARISTOKRAFT CABINETS.
3	INSULATE ALL EXPOSED PIPES AT SINKS PER ADA REQUIREMENTS, TYPICAL.
4	SEE ELECTRICAL DRAWINGS FOR OUTLET LOCATIONS AND NUMBERS.
5	COUNTER TOPS SHALL BE GRANITE

Owner
 Northland
 Enterprises LLC.

443 Congress

Portland, Maine

Enlarged Plans

Bathrooms

1/2" = 1'-0"

A 7.1