

1 GALLERY / PERFORMANCE SPACE [001]
A101 SCALE: 1/4" = 1'-0"

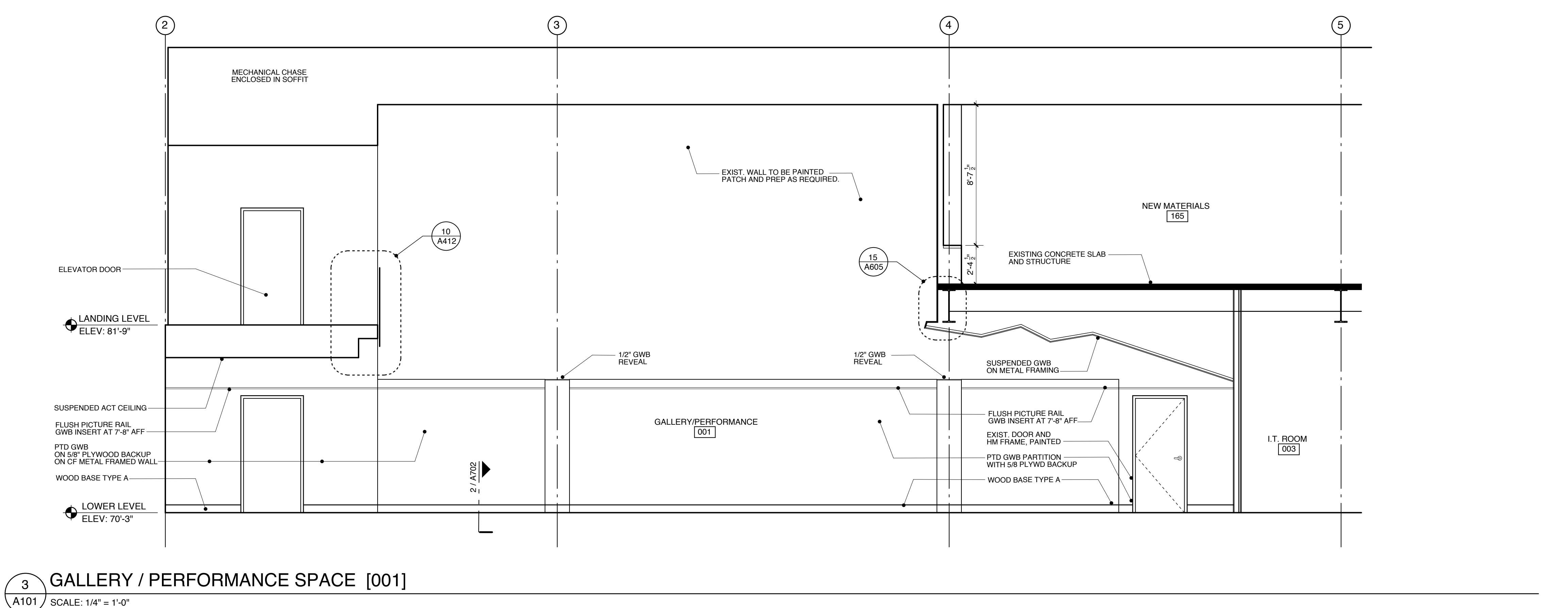

3 GALLERY / PERFORMANCE SPACE [001]
A101 SCALE: 1/4" = 1'-0"

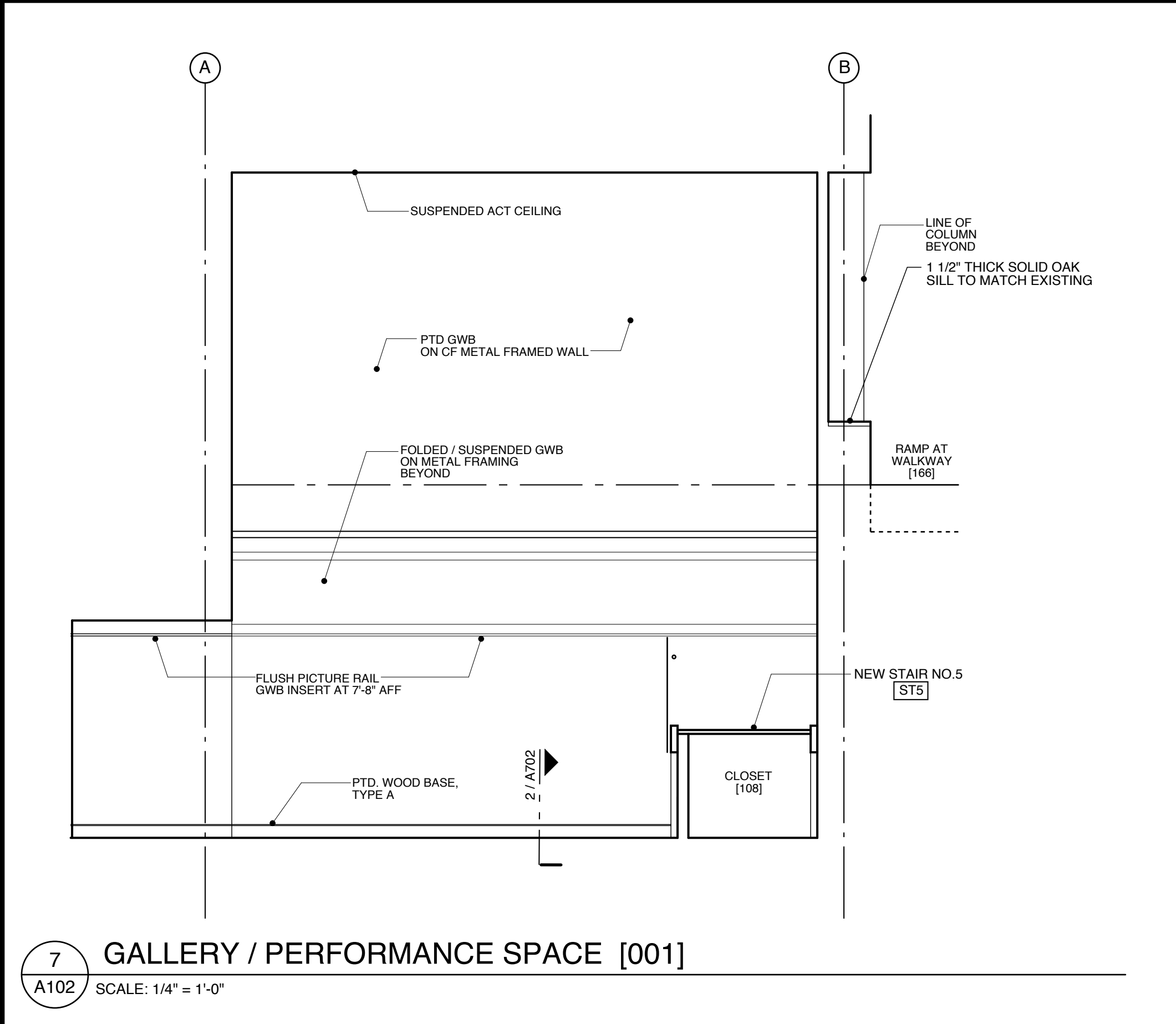

7 GALLERY / PERFORMANCE SPACE [001]
A102 SCALE: 1/4" = 1'-0"

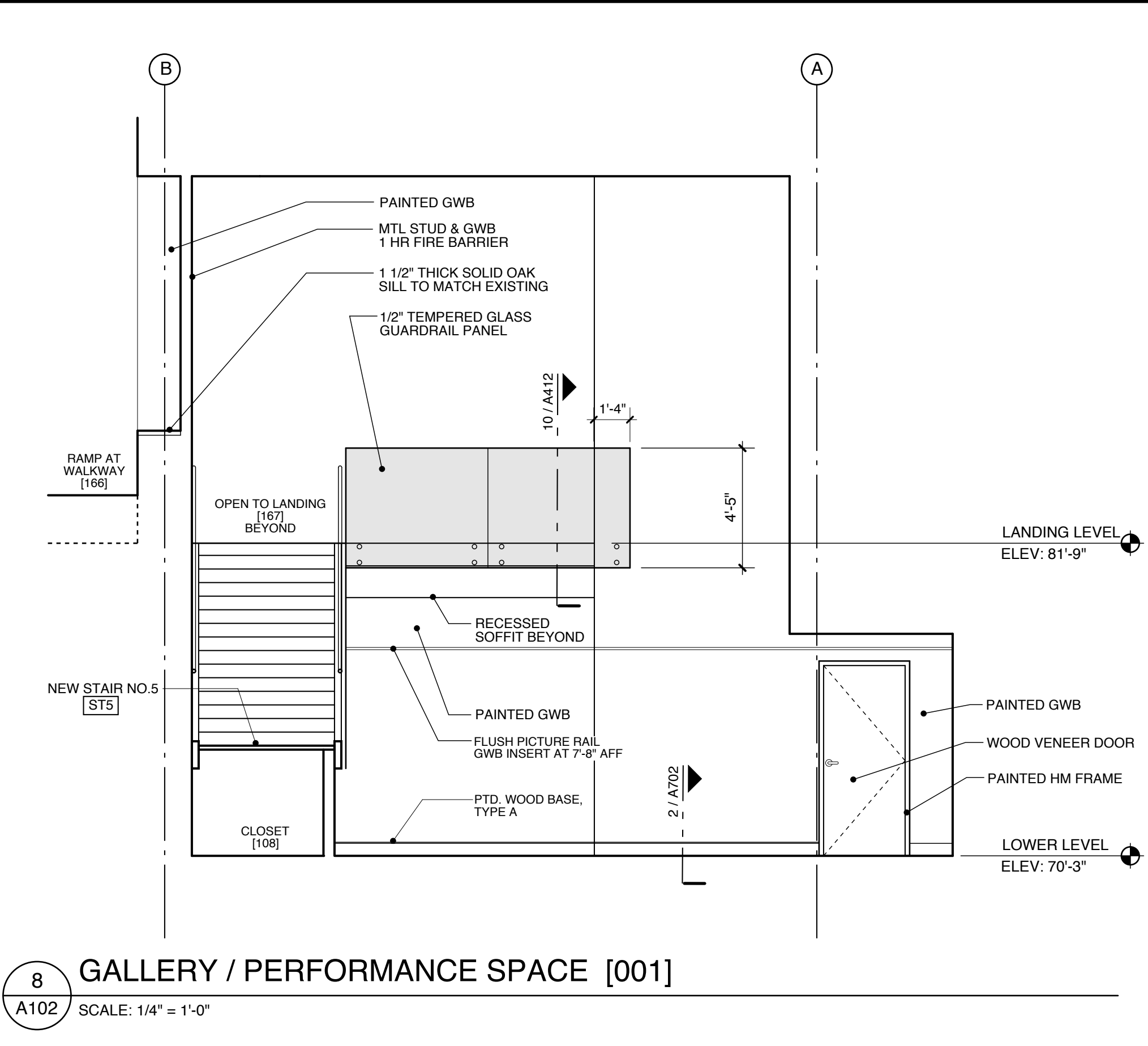

8 GALLERY / PERFORMANCE SPACE [001]
A102 SCALE: 1/4" = 1'-0"

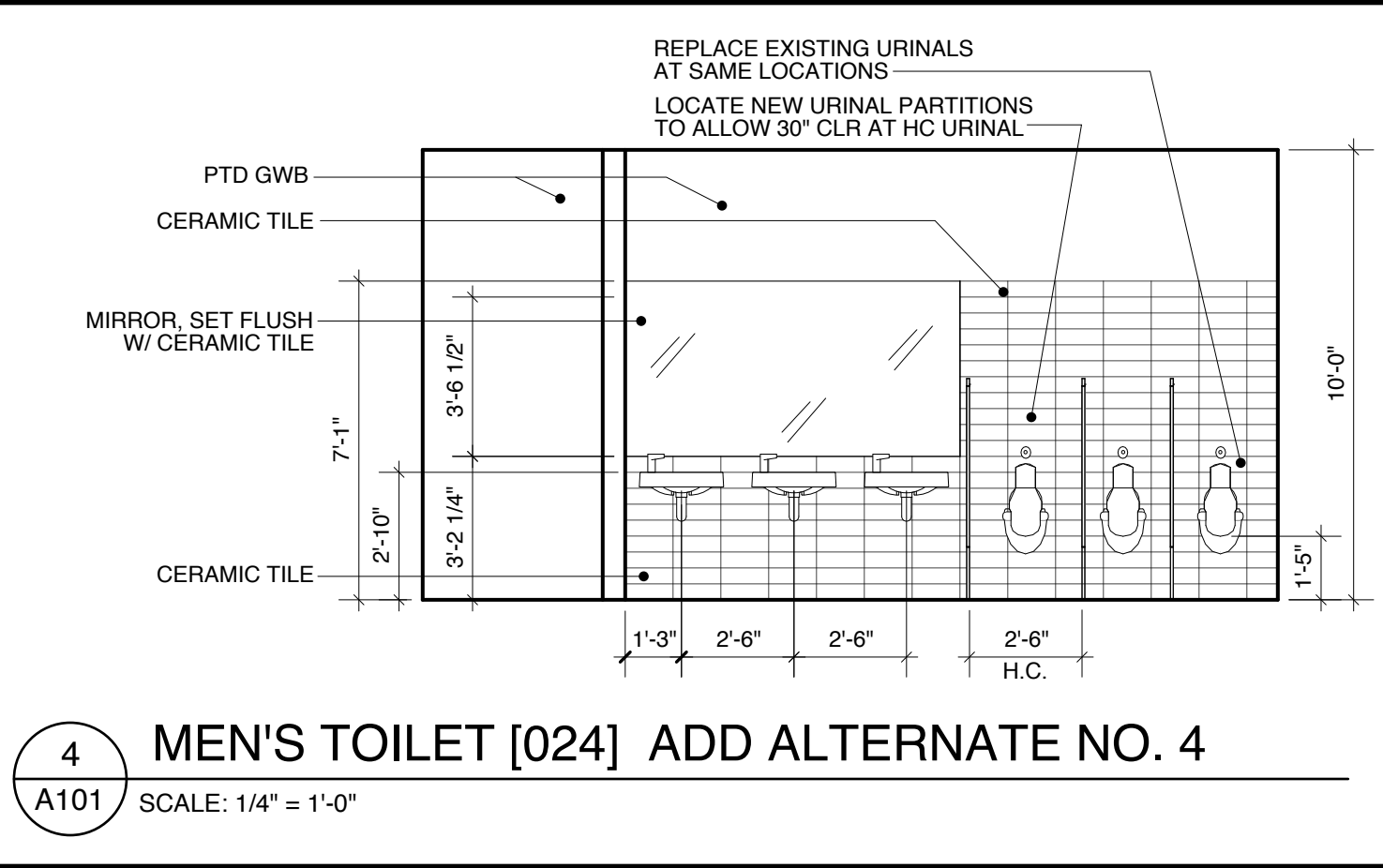

4 MEN'S TOILET [024] ADD ALTERNATE NO. 4
A101 SCALE: 1/4" = 1'-0"

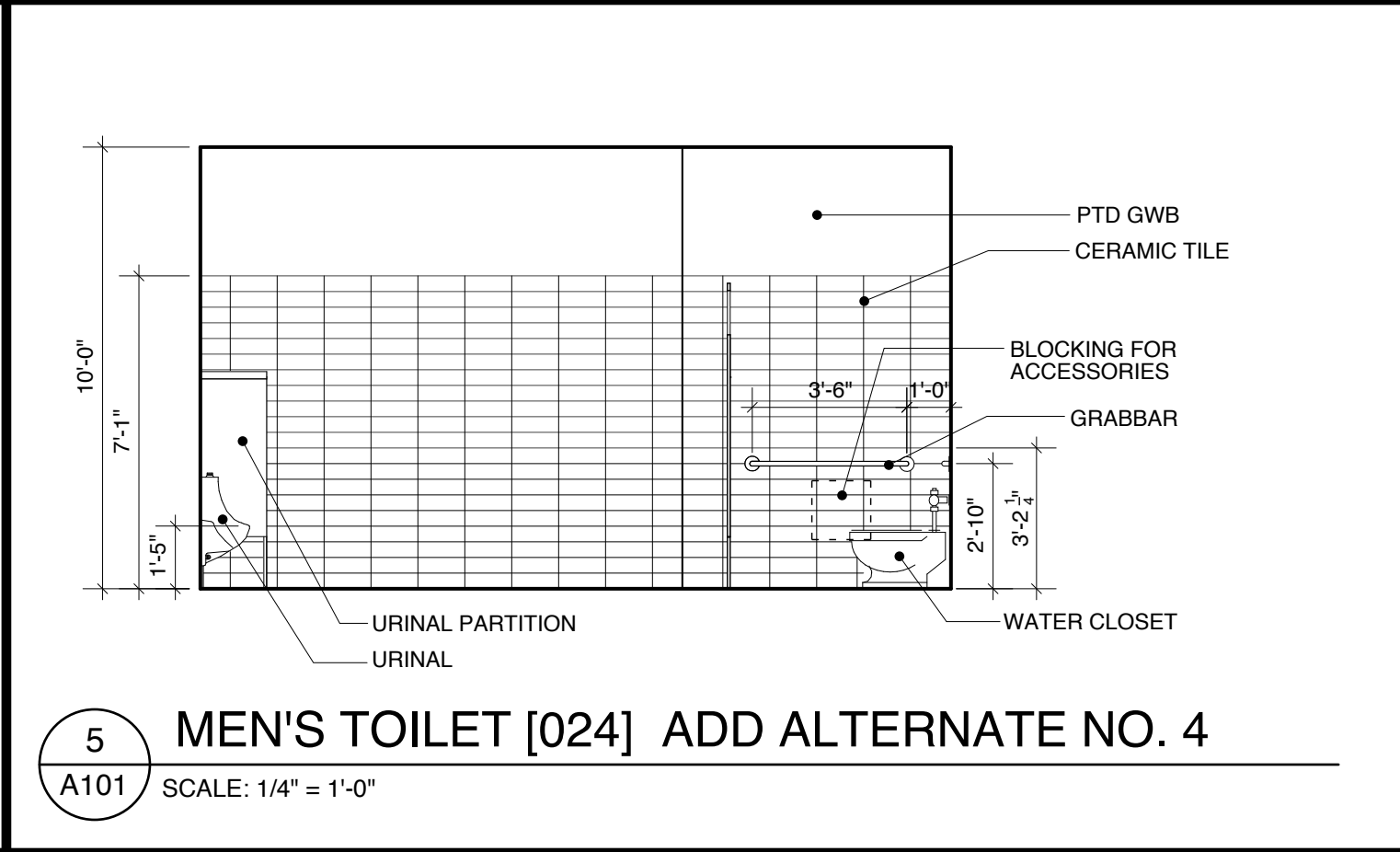

5 MEN'S TOILET [024] ADD ALTERNATE NO. 4
A101 SCALE: 1/4" = 1'-0"

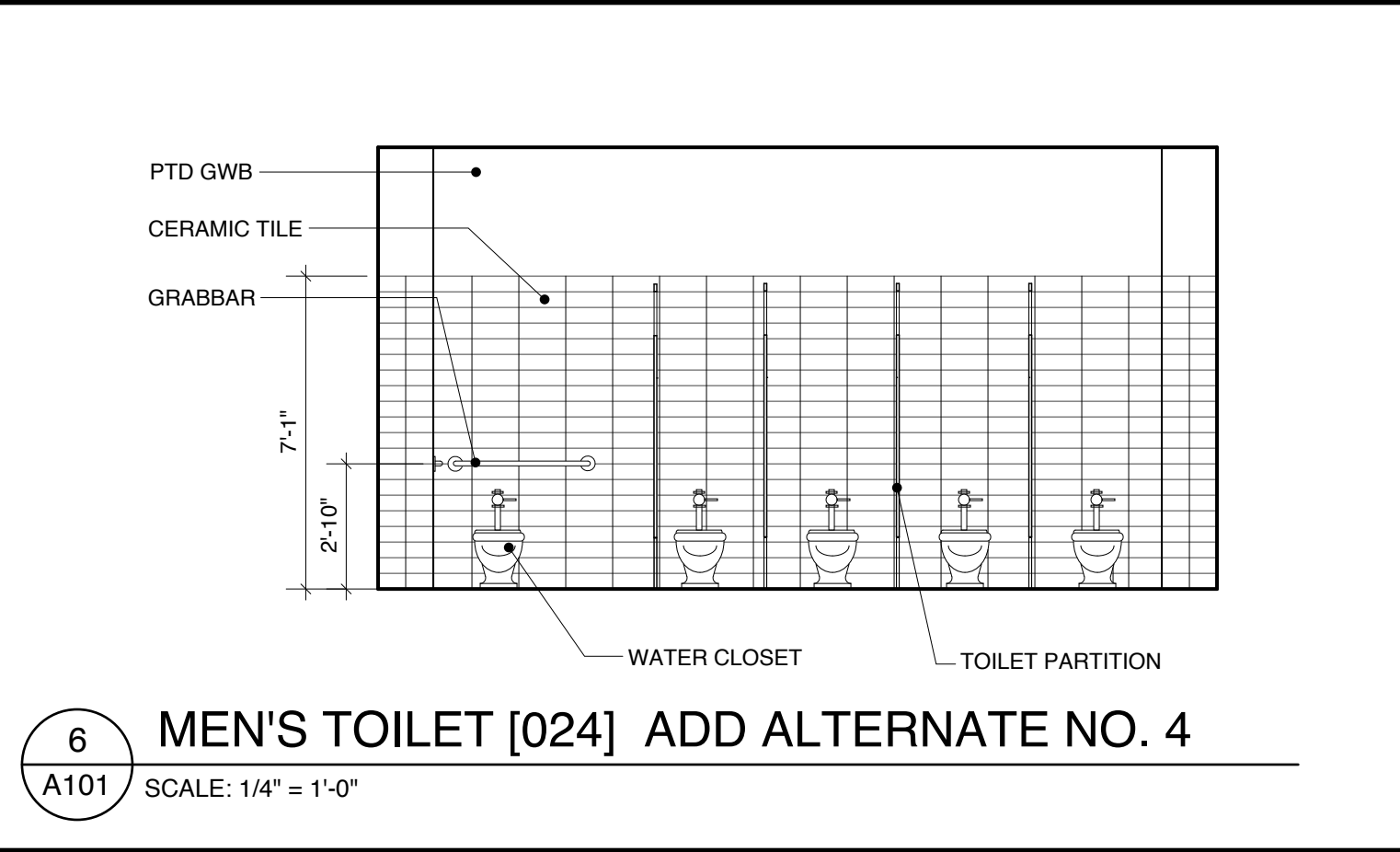

6 MEN'S TOILET [024] ADD ALTERNATE NO. 4
A101 SCALE: 1/4" = 1'-0"

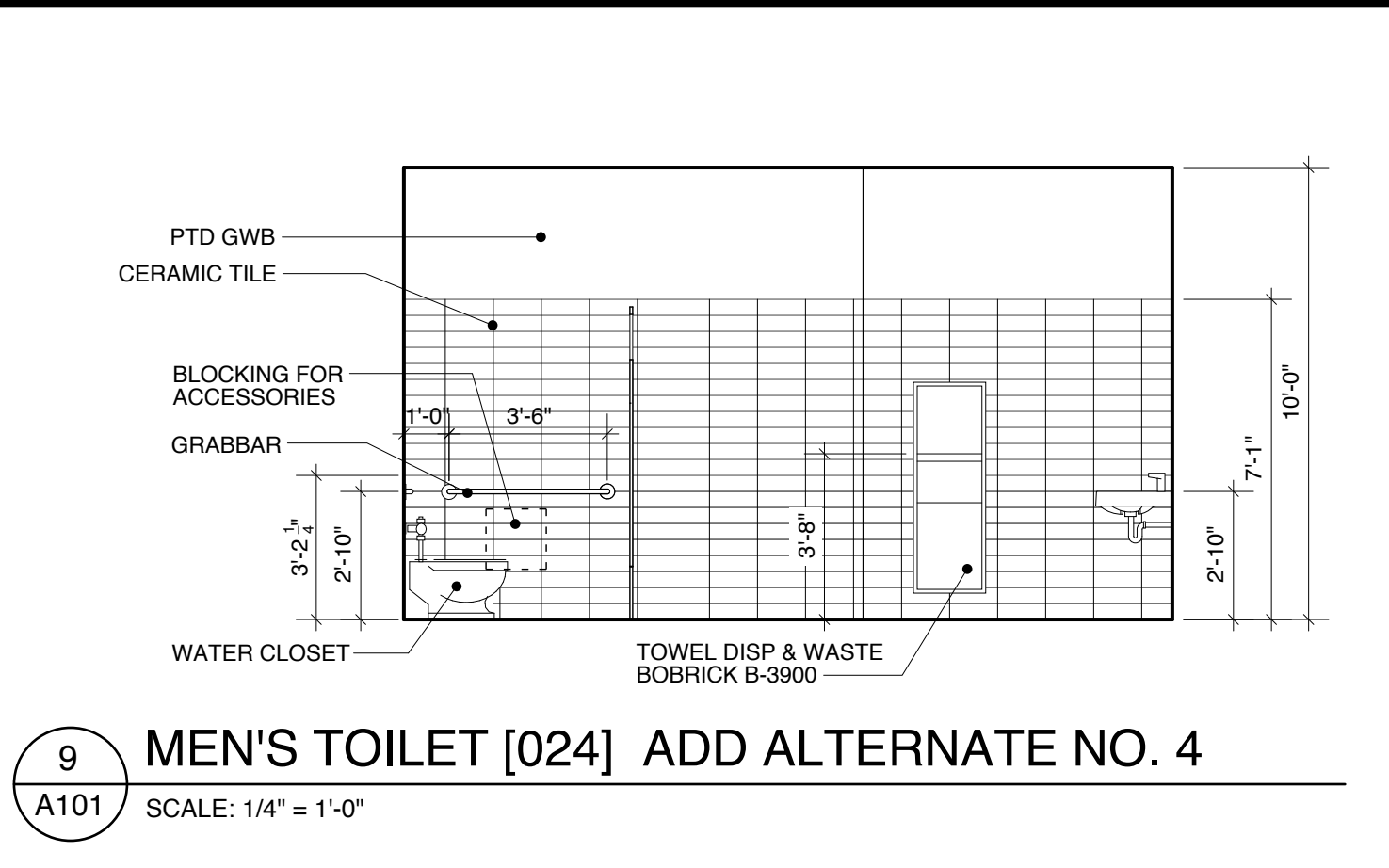

9 MEN'S TOILET [024] ADD ALTERNATE NO. 4
A101 SCALE: 1/4" = 1'-0"

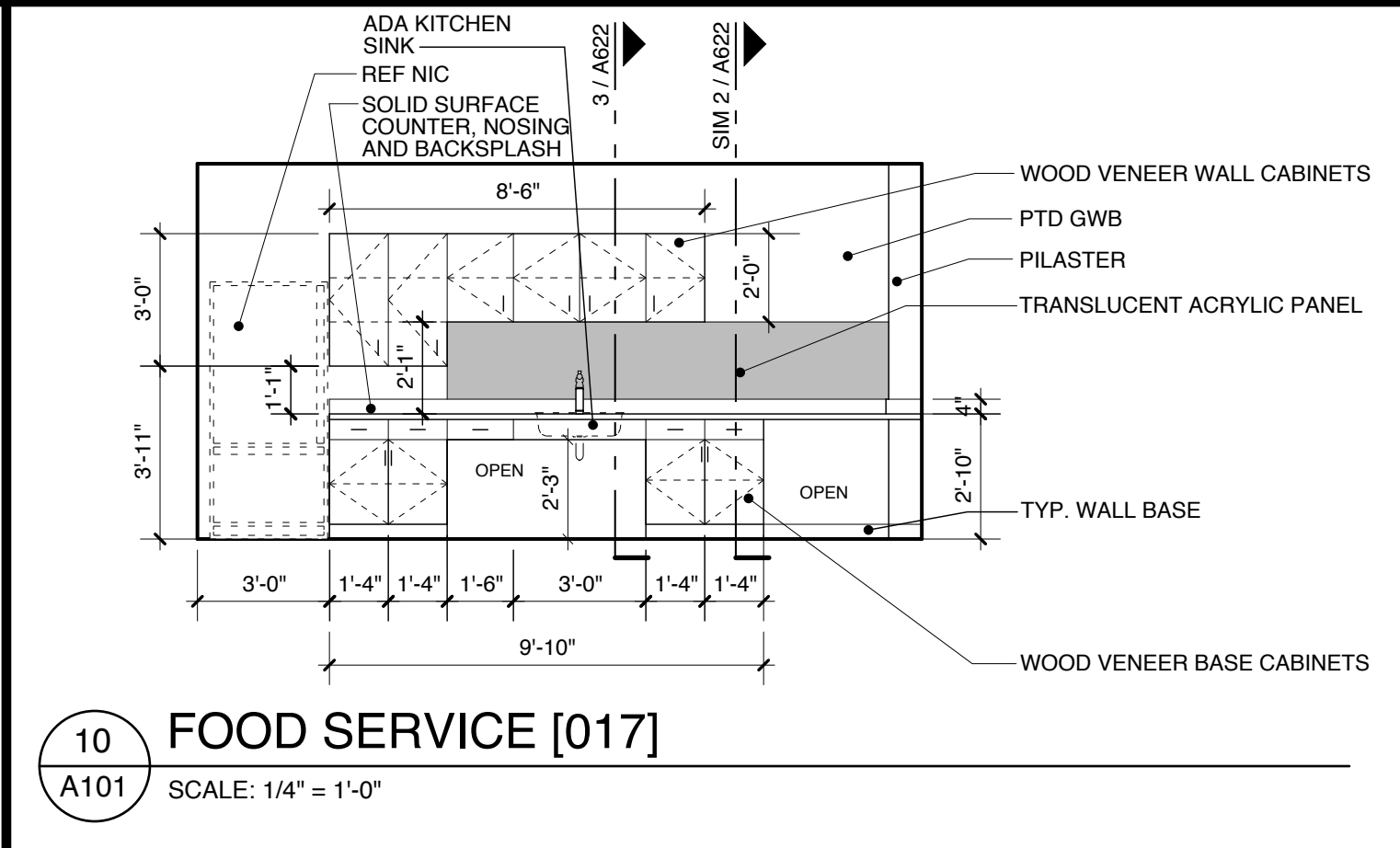

10 FOOD SERVICE [017]
A101 SCALE: 1/4" = 1'-0"

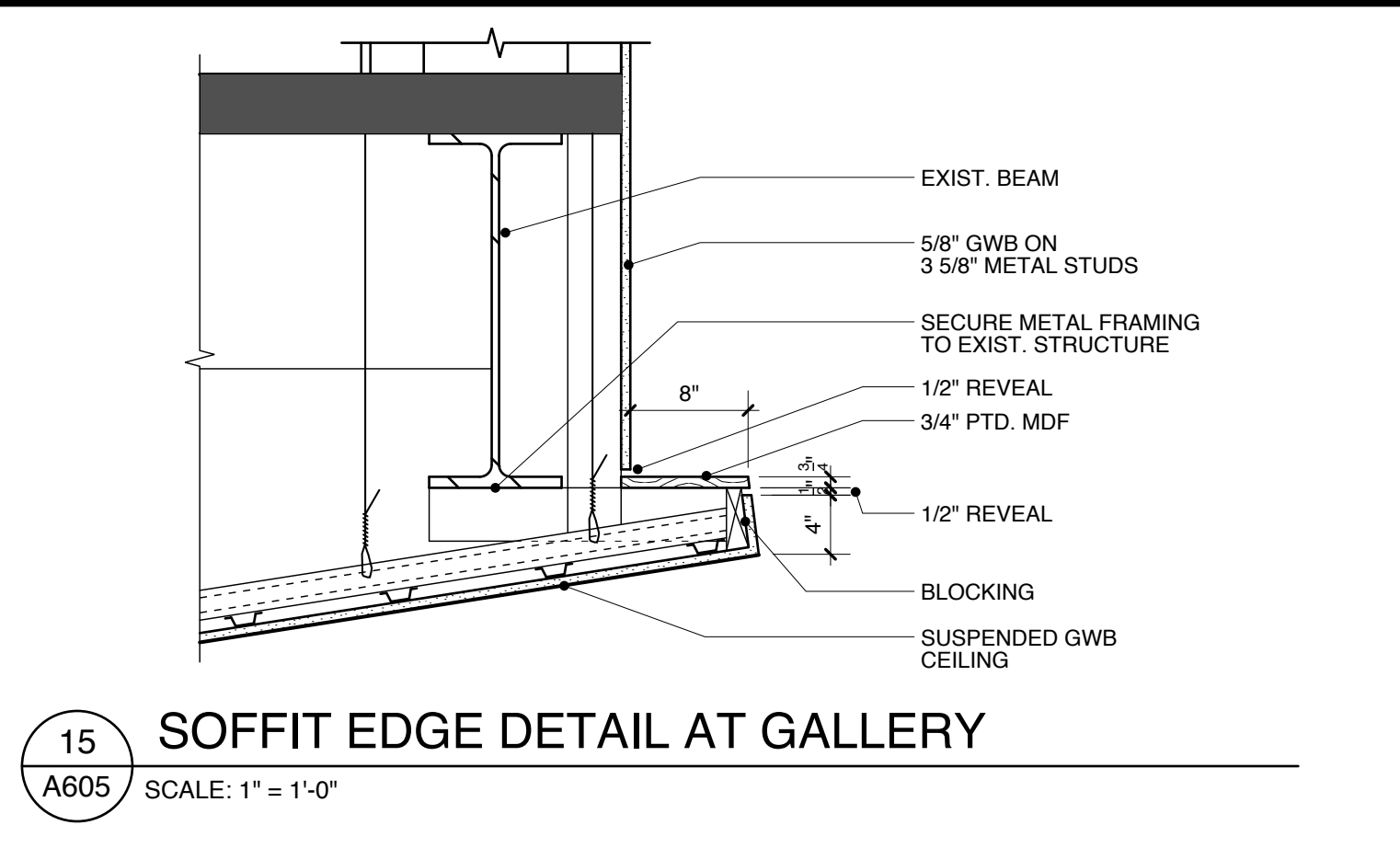

15 SOFFIT EDGE DETAIL AT GALLERY
A605 SCALE: 1" = 1'-0"

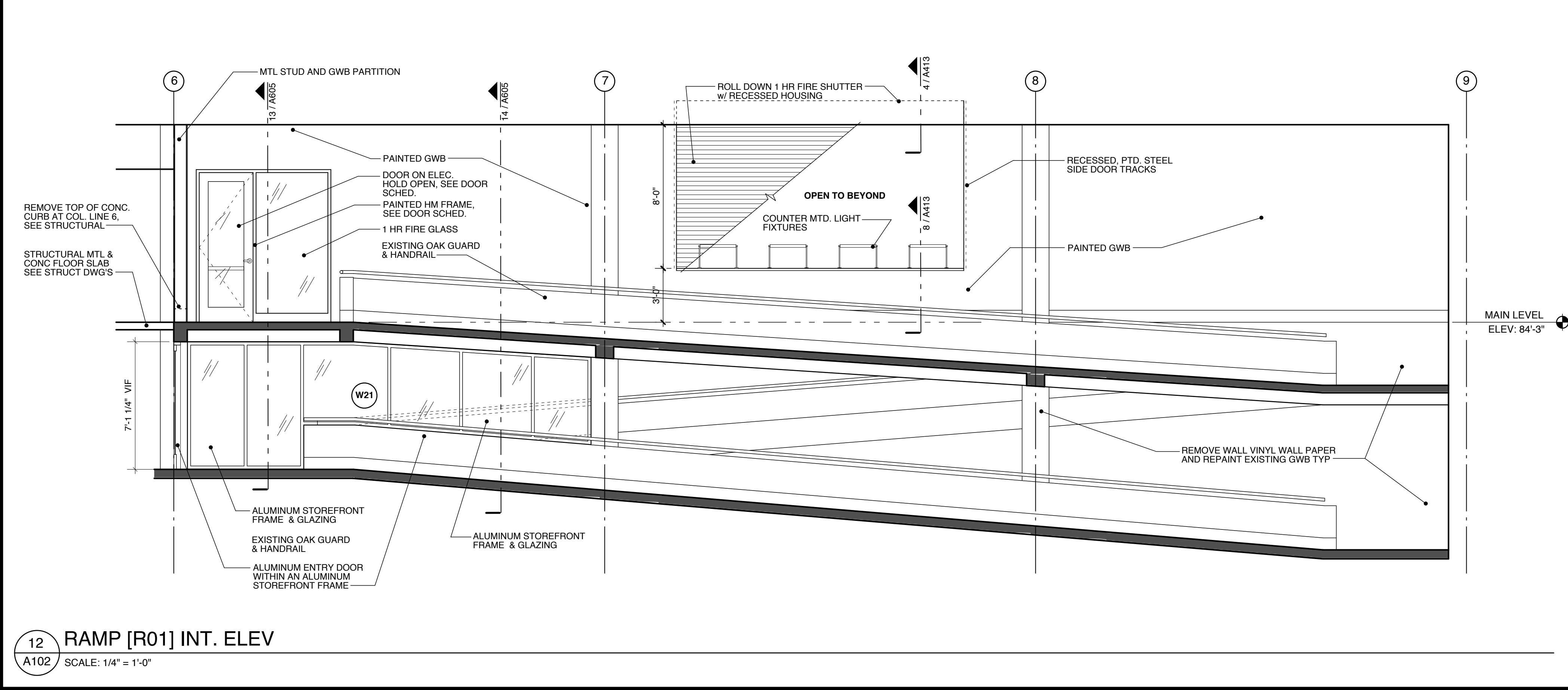

12 RAMP [R01] INT. ELEV
A102 SCALE: 1/4" = 1'-0"

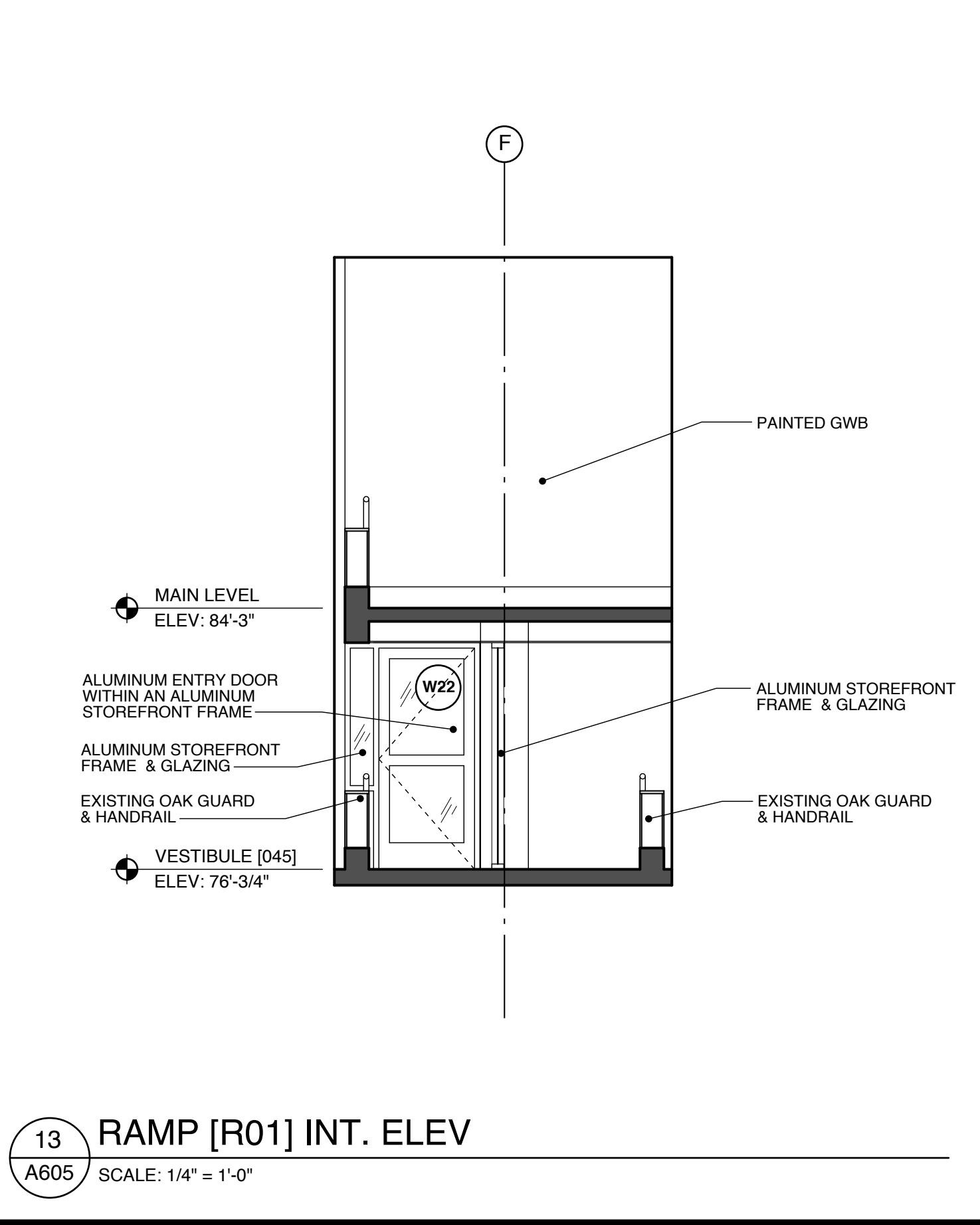

13 RAMP [R01] INT. ELEV
A605 SCALE: 1/4" = 1'-0"

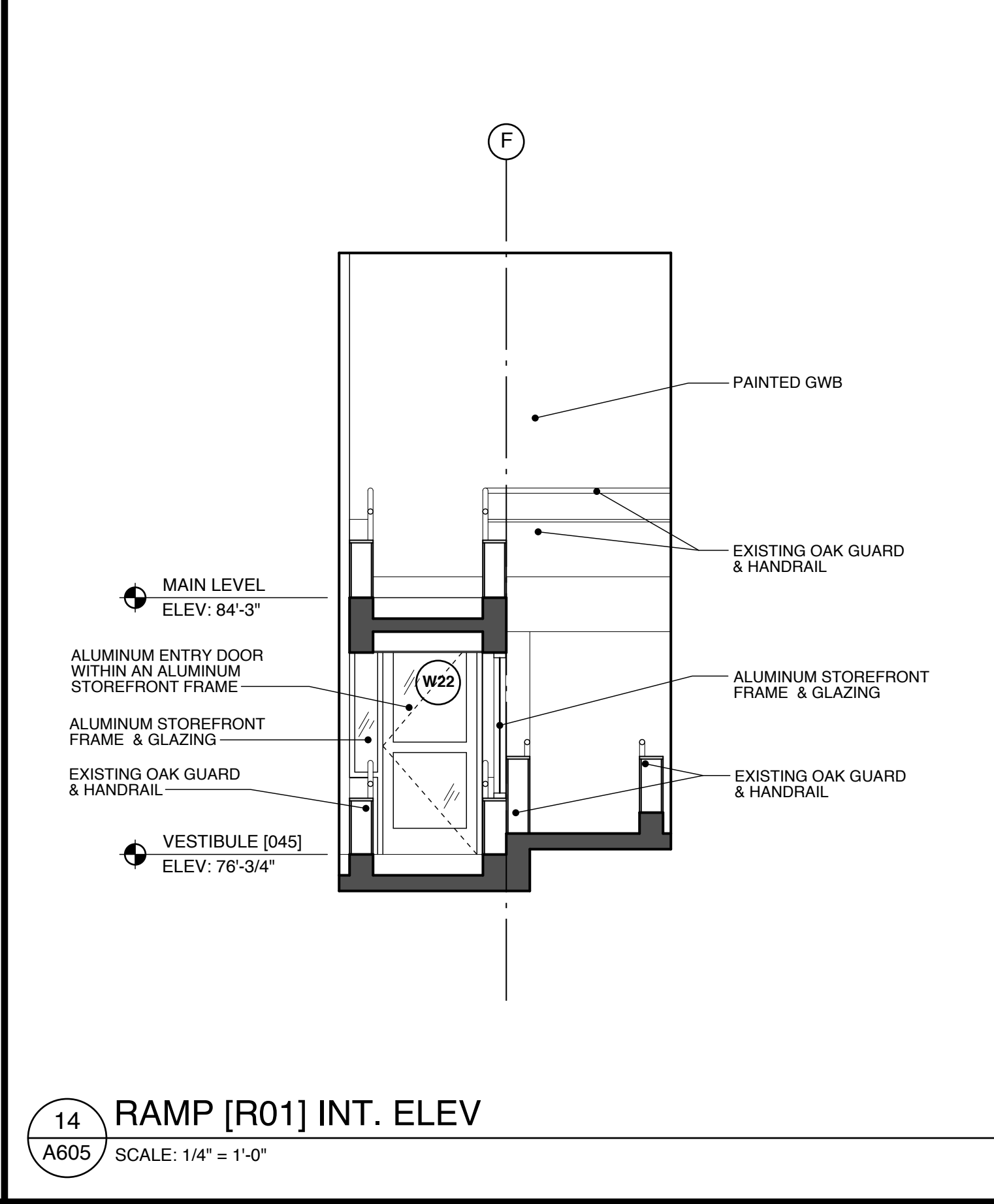

14 RAMP [R01] INT. ELEV
A605 SCALE: 1/4" = 1'-0"

<p>Scott Simons Architects 75 York Street Portland, Maine 04101 Tel: 207 772 4656 Fax: 207 626 4656 Web: www.simonsarchitects.com</p>	<p>PROJECT Portland Public Library Addition / Renovation</p> <p>5 MONUMENT SQUARE PORTLAND, ME</p>
	<p>TITLE INTERIOR ELEVATIONS</p>
<p>THIS DRAWING IS THE PROPERTY OF SCOTT SIMONS ARCHITECTS AND IS NOT TO BE COPIED OR REPRODUCED IN PART OR WHOLE.</p>	<p>STATUS: ISSUED FOR BIDDING CONSTRUCTION DOCUMENTS</p>
<p>DATE: 02.13.2009</p> <p>SCALE:</p> <p>PROJECT NO. 2008-0030</p> <p>DRAWN BY:</p>	<p>REVISION / DATE:</p>
<p>SCOTT R. SIMONS NO. 2034 STATE OF MAINE LICENSED ARCHITECT</p>	<p>DWG NO. A605</p>