

Technical Data Manual

Model Nos. and pricing: see Price List

VIESSMANN®

Vitocell 300-V

EVI Series

Indirect-fired domestic hot water storage tank
53 USG to 119 USG (200 L to 450 L) capacity



Product may not be exactly as shown

Vertical indirect-fired domestic hot water storage tank of high-grade stainless steel with two coils.

⚠ CAUTION

This tank version is not suitable for steam heating applications.



Benefits

Fully hygienic, efficient and economical domestic hot water production with DHW tanks of high-grade stainless steel – vertical version.

Benefits at a glance:

- Corrosion-resistant tank of high-grade SA 240-316 Ti stainless steel offers a long service life.
- Fully hygienic due to high quality homogeneous stainless steel surfaces.
- The high-alloy material is immune to cracking or peeling. The tank stays hygienic and requires only minimum service.
- Does not require a consumable anode for corrosion protection.
- The entire water content is heated by a 1 ¼ in. (34 mm) diameter stainless steel heat exchanger surface which extends to the bottom of the tank.
- The positioning of the tubular heat exchanger coil further ensures that 82 to 97% of the tank volume can be drawn at constant water temperature.
- The stainless steel heat exchanger coil is self-venting towards the top and self-draining towards the bottom, therefore not susceptible to reduced heat transfer due to air lock or deposits.
- Universally suitable – for applications requiring larger quantities of hot water, multiple vertical tanks can be combined via headers to form tank batteries.
- Standby losses minimized by 2 ¼ in. (58 mm) highly effective, foamed-in-place or 4 in. (100 mm) wrap-around PET HCFC-free insulation.
- Easy transport into mechanical room due to low weight and compact construction.
- Certified to CSA Low Lead Content Certification Program; including US Safe Drinking Water Act, NSF/ANSI 372 as well as other applicable US State requirements.

Cross Section

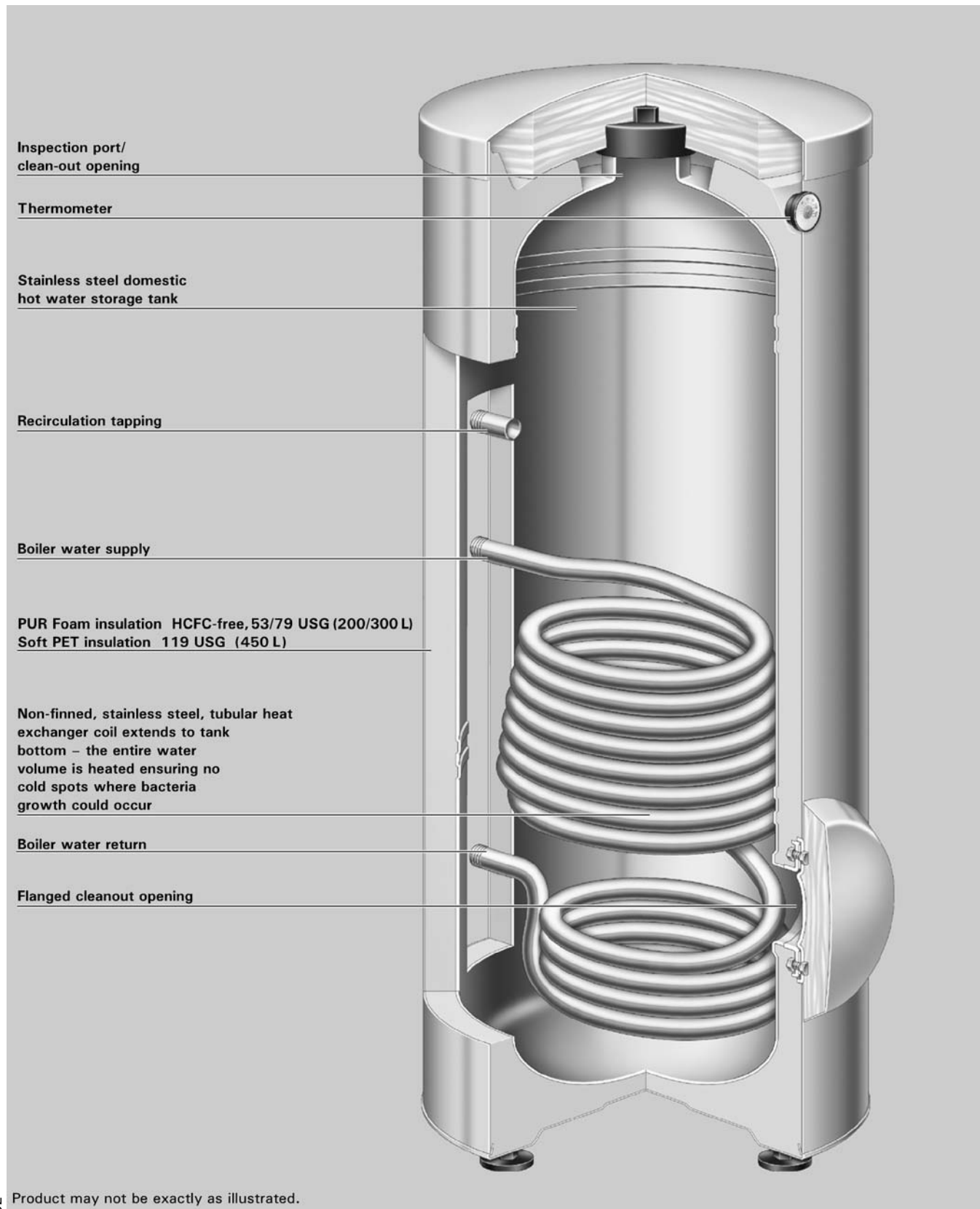

Inspection port/
clean-out opening

Thermometer

Stainless steel domestic
hot water storage tank

Recirculation tapping

Boiler water supply

PUR Foam insulation HCFC-free, 53/79 USG (200/300 L)
Soft PET insulation 119 USG (450 L)

Non-finned, stainless steel, tubular heat
exchanger coil extends to tank
bottom - the entire water
volume is heated ensuring no
cold spots where bacteria
growth could occur

Boiler water return

Flanged cleanout opening

Technical Data

For domestic hot water heating applications which utilize modulating and low temperature hot water heating boilers.

Suitable for heating systems with:

- max. working pressure on heat exchanger side up to 220 psig at 392°F (200°C)
- max. working pressure on DHW water side of up to 150 psig at 210°F (99°C)

Storage capacity	USG (L)	53 (200)	79 (300)	119 (450)	
Recovery rates* 1 with a DHW temperature rise of the domestic hot water from 50 to 140°F (10 to 60°C) and heating water supply temperature of..... at the supply flow rate stated below	194°F (90°C)	MBH (kW) GPH (L/h)	215 (63) 286 (1084)	280 (82) 372 (1410)	276 (81) 368 (1393)
	176°F (80°C)	MBH (kW) GPH (L/h)	164 (48) 218 (826)	201 (59) 268 (1014)	212 (62) 282 (1066)
	158°F (70°C)	MBH (kW) GPH (L/h)	99 (29) 132 (499)	140 (41) 186 (705)	147 (43) 195 (739)
Supply flow rate for the recovery rates stated	GPM (m ³ /h)	22.0 (5.0)	22.0 (5.0)	28.6 (6.5)	
Insulation		PUR Foam		Soft PET	
Standby losses* 2	MBH/24 h	5.5	6.8	9.2	
Dimensions* 3					
Tank length without insulation	in. (mm)	--	--	28 (715)	
Overall length with insulation	in. (mm)	23 (581)	25 (633)	36 ³ / ₈ (925)	
Tank width without insulation	in. (mm)	--	--	36 (914)	
Overall width with insulation	in. (mm)	25 ¹ / ₂ (649)	27 ³ / ₄ (704)	38 ³ / ₈ (975)	
Tank height without insulation	in. (mm)	--	--	65 ⁵ / ₈ (1667)	
Overall height with insulation* 4	in. (mm)	56 (1420)	70 (1779)	68 ¹ / ₂ (1738)	
Tilt height without insulation	in. (mm)	--	--	66 ¹ / ₂ (1690)	
Tilt height with insulation	in. (mm)	58 (1471)	71 ³ / ₄ (1821)	--	
Weight					
Tank with insulation	lbs (kg)	76 (168)	100 (220)	111 (245)	
Heating water content (heat exchanger pipe coil)	USG (L)	2.64 (10)	2.91 (11)	4.0 (15)	
Heat exchanger surface area	ft. ² (m ²)	14 (1.3)	16 (1.5)	20.5 (1.9)	
Connections					
Heating water supply/return	in. (male NPT thread)	1	1	1 ¹ / ₄	
Domestic cold/hot water	in. (male NPT thread)	1	1	1 ¹ / ₄	
Temp. and press. relief valve	in. (male NPT thread)	1	1	1 ¹ / ₄	
Recirculation	in. (male NPT thread)	1	1	1 ¹ / ₄	

*1 When planning for the recovery rate as stated or calculated, allow for the corresponding circulation pump.

The stated recovery rate is only achieved when the rated output of the boiler is equal to or greater than that stated under "Recovery rates".

*2 Measured values are based on a room temperature of 68°F (20°C) and a domestic hot water temperature of 149°F (65°C) and can vary by ± 5%.

*3 For other dimensions, see illustrations and table on page 4.

*4 Adjustable feet can be adjusted up to 2 in. (50 mm).

For information regarding other Viessmann System Technology componentry, please reference documentation of the respective product.

79 USG (300 L) Tank Dimensions

53 USG (200 L) and 79 USG (300 L) Tanks

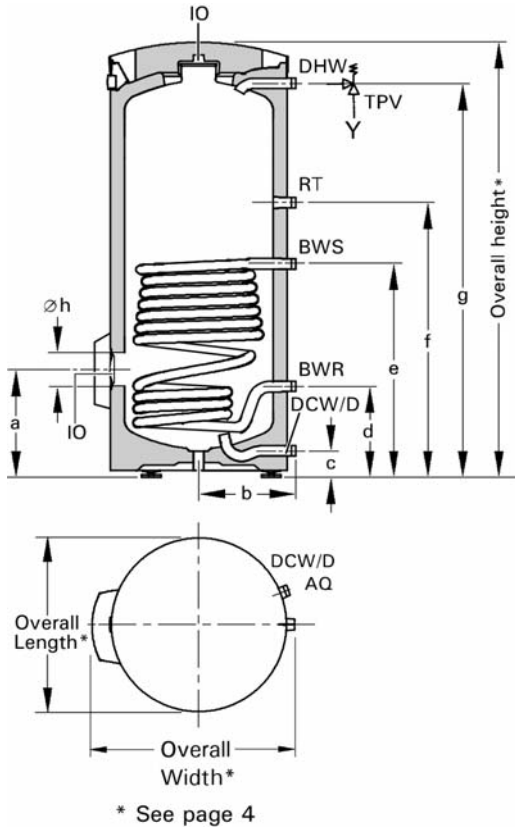

Dimensions			
Storage capacity	USG (L)	53 (200)	79 (300)
a	in. (mm)	14 (353)	14¼ (357)
b	in. (mm)	12½ (317)	13½ (343)
c	in. (mm)	3½ (87)	3½ (87)
d	in. (mm)	11¾ (297)	12 (301)
e	in. (mm)	27½ (697)	29½ (751)
f	in. (mm)	35⅓ (897)	37½ (951)
g	in. (mm)	50⅝ (1286)	64½ (1640)
h	in. (mm)	4 (100)	4 (100)

Legend

- AQ Aquastat well
- BWR Boiler water return
- BWS Boiler water supply
- D Drain
- DCW Domestic cold water
- DHW Domestic hot water
- IO Inspection and clean-out opening
- RT Recirculation tapping
- TPV Temperature and pressure relief valve

119 USG (450 L) Tank

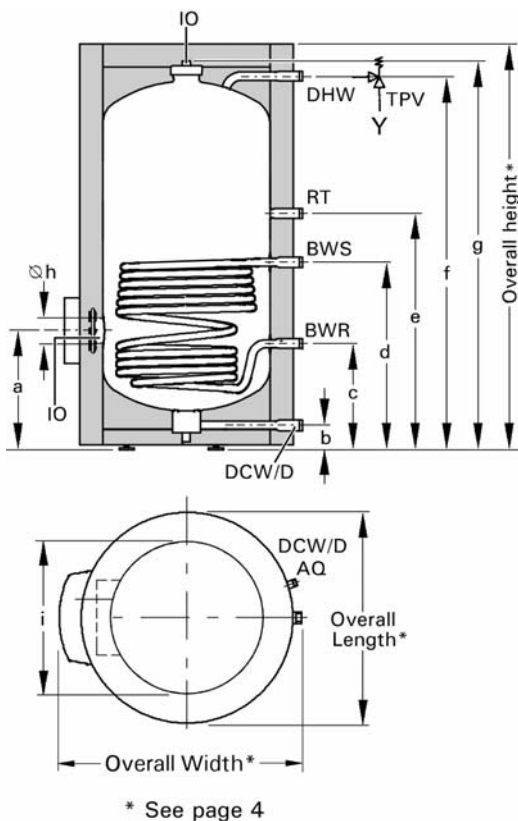

Dimensions		
Storage capacity	USG (L)	119 (450)
a	in. (mm)	20 (508)
b	in. (mm)	4 (102)
c	in. (mm)	18 (453)
d	in. (mm)	31⅝ (802)
e	in. (mm)	40 (1012)
f	in. (mm)	63 (1601)
g	in. (mm)	65⅝ (1667)
h	in. (mm)	4 (100)
i	in. (mm)	28 (715)

Legend

- AQ Aquastat well
- DHW Domestic hot water
- BWR Boiler water return
- IO Inspection and cleanout opening
- BWS Boiler water supply
- TPV Temperature and pressure relief valve
- D Drain
- RT Recirculation tapping
- DCW Domestic cold water

Water Flow

Domestic hot water draw rate

Storage tank contents heated to 140°F (60°C), boiler not reheating.

Storage capacity	USG (L)	53 (200)	79 (300)	119 (450)
Domestic hot water draw rate	GPM (L/min)	2.6 (10)	4.0 (15)	4.0 (15)
Domestic hot water draw water with t = 140°F (60°C) (constant)	USG (L)	37 (139)	72 (272)	109 (413)
% tank volume		70	91	92

Heat-up time

The stated heating times are achieved when the maximum recovery rate of the domestic hot water tank is made available at the respective supply temperature and with a domestic hot water rise from 50 to 140°F (10 to 60°C).

Storage capacity	USG (L)	53 (200)	79 (300)	119 (450)
Heating water supply temperature	Heat-up time (minutes)			
194°F (90°C)		11.4	15.5	20
176°F (80°C)		15	21.5	24
158°F (70°C)		23.5	32.5	35

Pressure drop on domestic hot water side (secondary circuit)

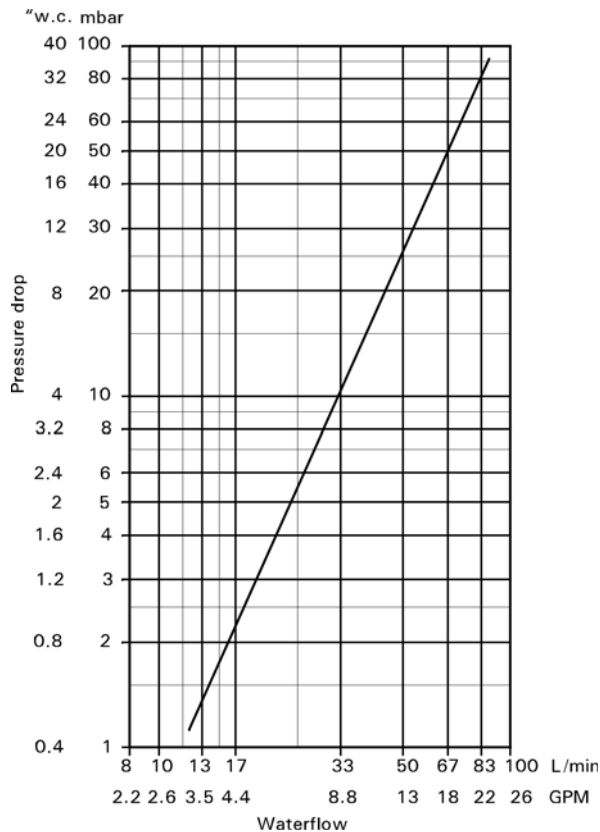

Pressure drop on heating water side (primary circuit)

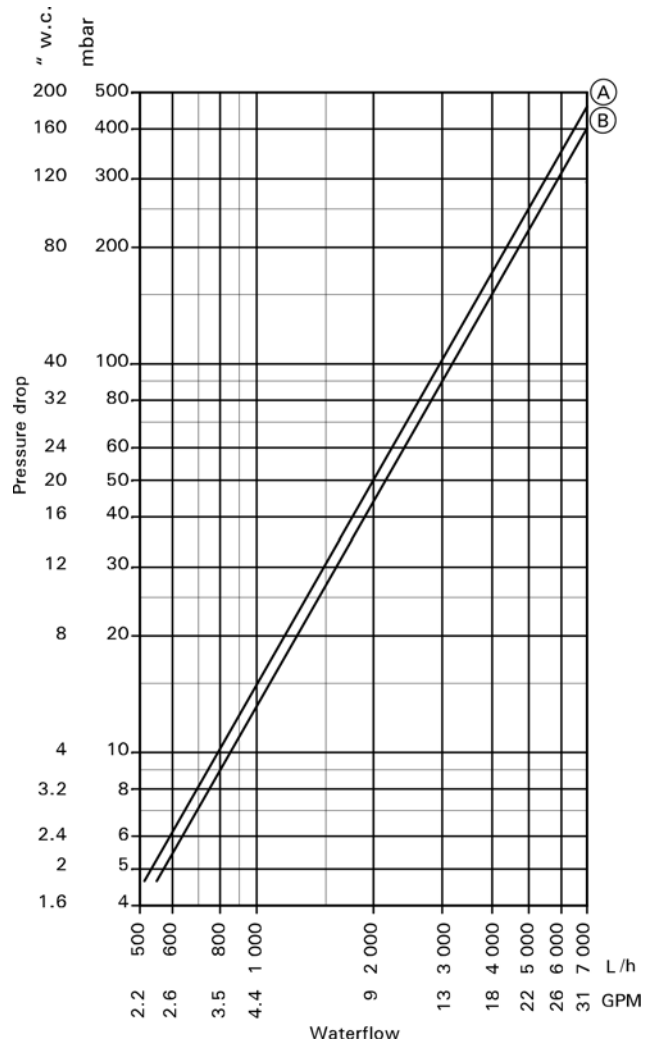

Legend

- Ⓐ 79 USG (300 L) and 119 USG (450 L) storage capacity
- Ⓑ 53 USG (200 L) storage capacity

Multiple Tank Installation

Technical data

The 79 and 119 USG (300 and 450 L) tank sizes may be combined into a battery consisting of between 2 and 3 tanks. Tank batteries consisting of more than 3 tanks can be installed by creating up to 4 batteries, each consisting of 3 tanks. The heating contractor is responsible to ensure proper piping on both the primary and secondary circuits.

Tank storage capacity		USG (L)	79 (300)	119 (450)	
Total capacity of tank battery		USG (L)	158 (600)	238 (900)	357 (1350)
Number of storage tanks			2	2	3
Recovery rates *1 with a temperature rise of the domestic hot water from 50 to 140°F (10 to 60°C) and heating water supply temperature of.... at the supply flow rate stated below	194°F (90°C)	MBH (kW) GPH (L/h)	560 (164) 74.5 (2820)	553 (162) 73.8 (2786)	829 (243) 1104 (4179)
	176°F (80°C)	MBH (kW) GPH (L/h)	403 (118) 534 (2028)	423 (124) 564 (2132)	635 (186) 846 (3198)
	158°F (70°C)	MBH (kW) GPH (L/h)	280 (82) 372 (1410)	293 (86) 390 (1479)	440 (129) 588 (2217)
Supply flow rate for the recovery rates stated		GPH (m3/h)	2640 (10)	3420 (13)	5160 (19.5)
Standby losses *2		MBH/24 h	13.6	18.4	27.6
Heat exchanger surface area		ft. ² (m ²)	30.1 (2.8)	38.8 (3.6)	58.1 (5.4)

- *1 When planning for the recovery rate as stated or calculated, allow for the corresponding circulation pump. The stated recovery rate is only achieved when the rated output of the boiler is equal to or greater than that stated under "Recovery rates".
- *2 Measured values are based on a room temperature of 68°F (20°C) and a domestic hot water temperature of 149°F (65°C) and can vary by ± 5%.

Installation of additional aquastat(s)

 **WARNING**

In a multiple-tank installation, it is recommended that an additional high limit aquastat be installed in the common domestic hot water supply header to the system. This aquastat should be wired in series to the operating aquastat on the tank battery. The setting on this additional high limit aquastat should be approximately 9°F (5°C) higher than the operating high limit.

Ensure that temperature tempering valve(s) is installed if the domestic hot water storage tank temperature exceeds 140°F (60°C) to protect from scalding. Consult plumbing codes and authorities for local requirements.

Multiple Tank Installation *(continued)*

For domestic hot water heating applications which utilize modulating and low temperature hot water heating boilers

Examples of multiple tank installations (shown below) - All fittings including manifolds are field supplied.

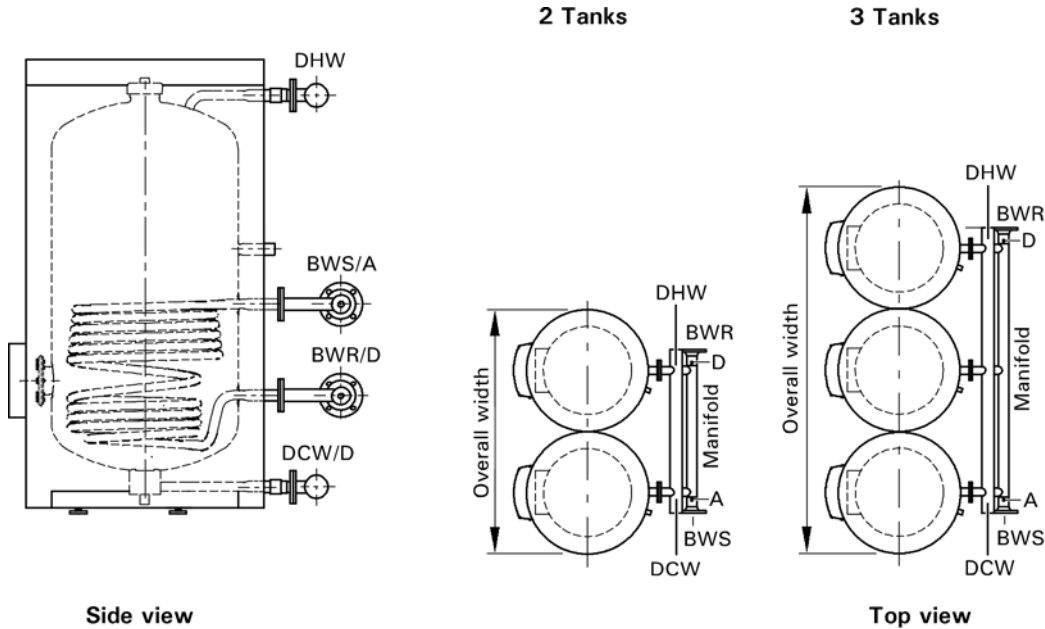

Legend

- A Air vent
- DCW Domestic cold water
- DHW Domestic hot water
- BWR Boiler water return
- BWS Boiler water supply
- D Drain

Storage tank capacity		79 USG (300 L)	119 USG (450 L)	
Number of storage tanks		2	2	3
Common header size boiler supply / return	in. (mm)	2 (51)	2 (51)	2 (51)
Common header size domestic hot / cold water	in. (mm)	1¼ (32)	1¼ (32)	1½ (38)
Dimensions with insulation				
Overall width *1	in. (mm)	52 (1321)	70 (1778)	106 (2692)

*1 Overall width includes 2" clearance space between the tanks.

Multiple Tank Installation *(continued)*

Domestic hot water draw rate

Storage tank content heated to 140°F (60°C),
boiler not reheating

Storage tank capacity	USG (L)	79 USG (300 L)	119 USG (450 L)	
Number of storage tanks		2	2	3
Battery storage capacity	USG (L)	158 (600)	238 (900)	357 (1350)
DHW draw rate	GPM (L/min)	7.9 (30)	7.9 (30)	11.9 (45)
Domestic hot water draw Water with t = 140°F (60°C) (constant)	USG (L)	143.7 (544)	243 (920)	365 (1380)
% of battery volume		93	92	92

Quick recovery (over 10-minute period)

Domestic hot water rise from 50 to 113°F (10 to 45°C)

Storage tank capacity	USG (L)	79 USG (300 L)	119 USG (450 L)	
Number of storage tanks		2	2	3
Battery storage capacity	USG (L)	158 (600)	238 (900)	357 (1350)
Heating water supply temperature		Quick DHW recovery (over 10-minute period)		
194°F (90°C)	USG/10 min (L/10 min)	237 (898)	314 (1190)	422 (1600)
176°F (80°C)	USG/10 min (L/10 min)	229 (870)	314 (1190)	422 (1600)
158°F (70°C)	USG/10 min (L/10 min)	184 (698)	277 (1050)	388 (1470)

Max. domestic hot water draw rate (over 10-minute period)

Domestic hot water rise from 50 to 113°F (10 to 45°C)

Storage tank capacity	USG (L)	79 USG (300 L)	119 USG (450 L)	
Number of storage tanks		2	2	3
Battery storage capacity	USG (L)	158 (600)	238 (900)	357 (1350)
Heating water supply temperature		Max. DHW draw rate (over 10-minute period)		
194°F (90°C)	GPM (L/min)	23.5 (90)	32 (120)	42.3 (160)
176°F (80°C)	GPM (L/min)	23 (87)	32 (120)	42.3 (160)
158°F (70°C)	GPM (L/min)	18.5 (70)	26.6 (101)	39 (148)

Water Flow

Continuous Flow Capacity Chart for 53 USG (200 L)

- Curve (A) Domestic hot water 40 to 140°F (4 to 60°C)
- Curve (B) Domestic hot water 40 to 176°F (4 to 80°C)

Domestic hot water delivery rate

(A)	(B)
4- 60° C	4- 80° C
40- 140° F	40- 176° F

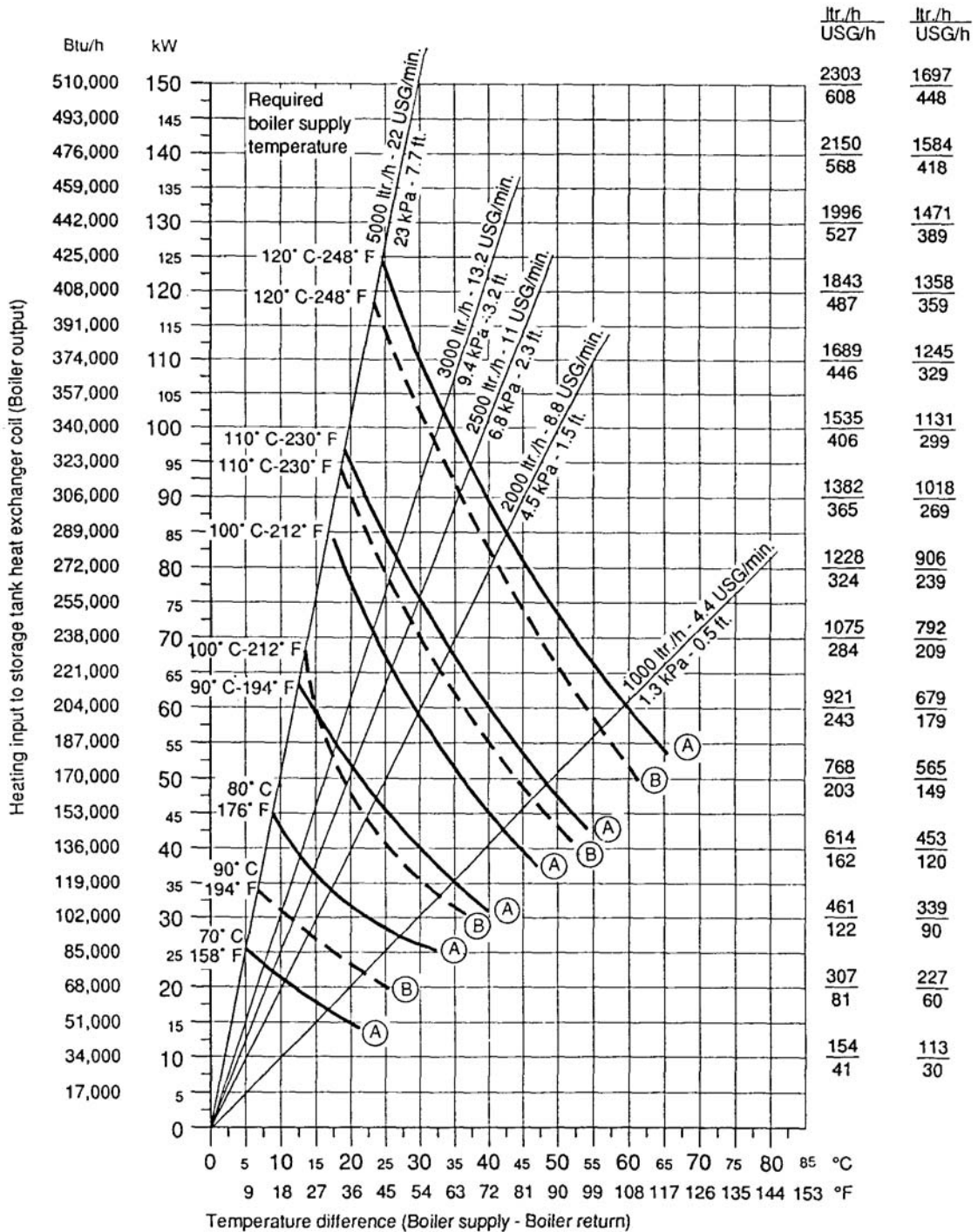

Water Flow *(continued)*

Continuous Flow Capacity Chart for 79 USG (300 L)

- Curve (A) Domestic hot water 40 to 140°F (4 to 60°C)
- Curve (B) Domestic hot water 40 to 176°F (4 to 80°C)

Domestic hot water delivery rate

(A)	(B)
4- 60° C	4- 80° C
40- 140° F	40- 176° F

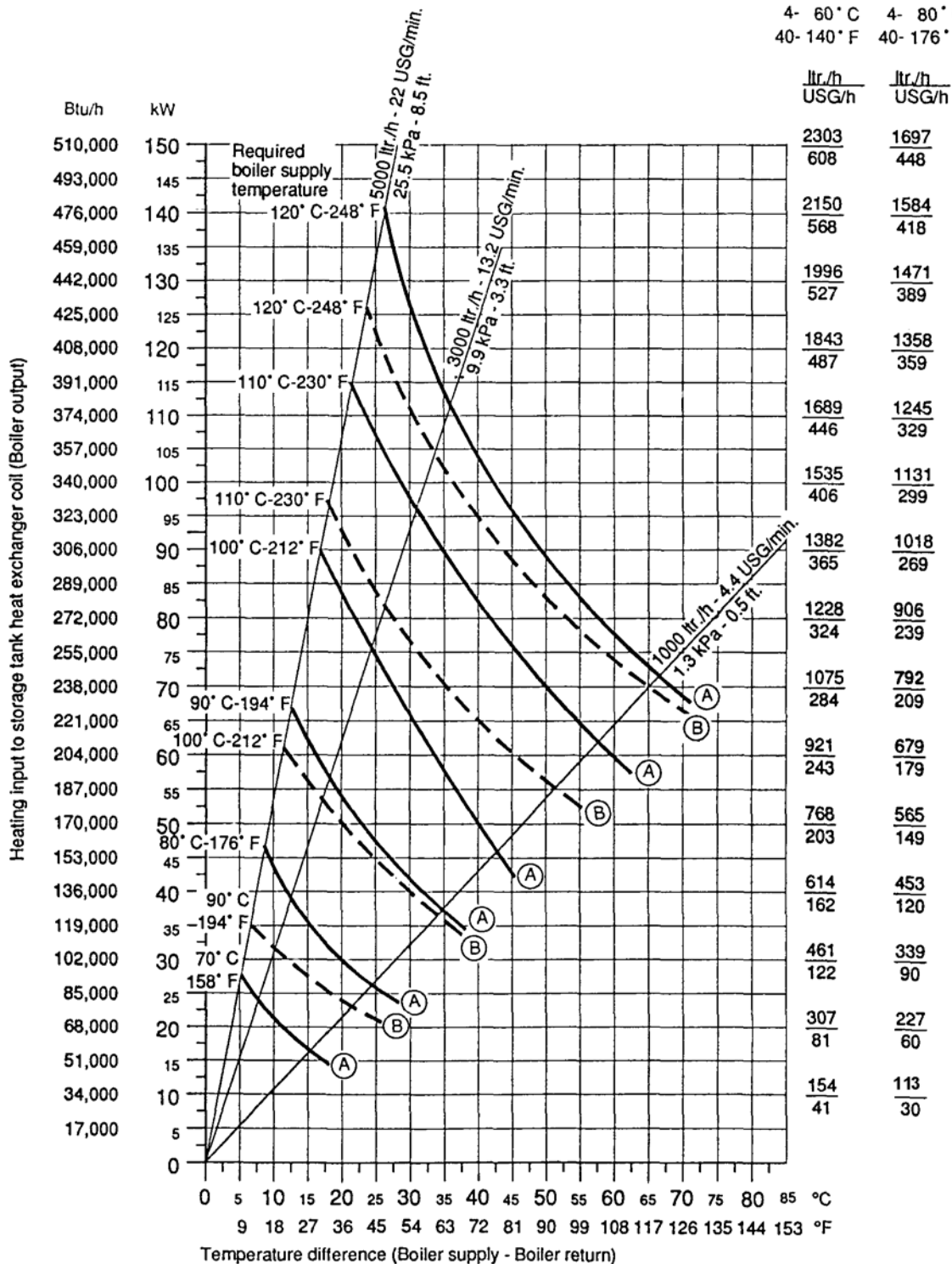

Water Flow *(continued)*

Continuous Flow Capacity Chart for 119 USG (450 L)

- Curve (A) Domestic hot water 40 to 140°F (4 to 60°C)
- Curve (B) Domestic hot water 40 to 176°F (4 to 80°C)

Domestic hot water
delivery rate

(A)	(B)
4- 60°C	4- 80°C
40- 140°F	40- 176°F

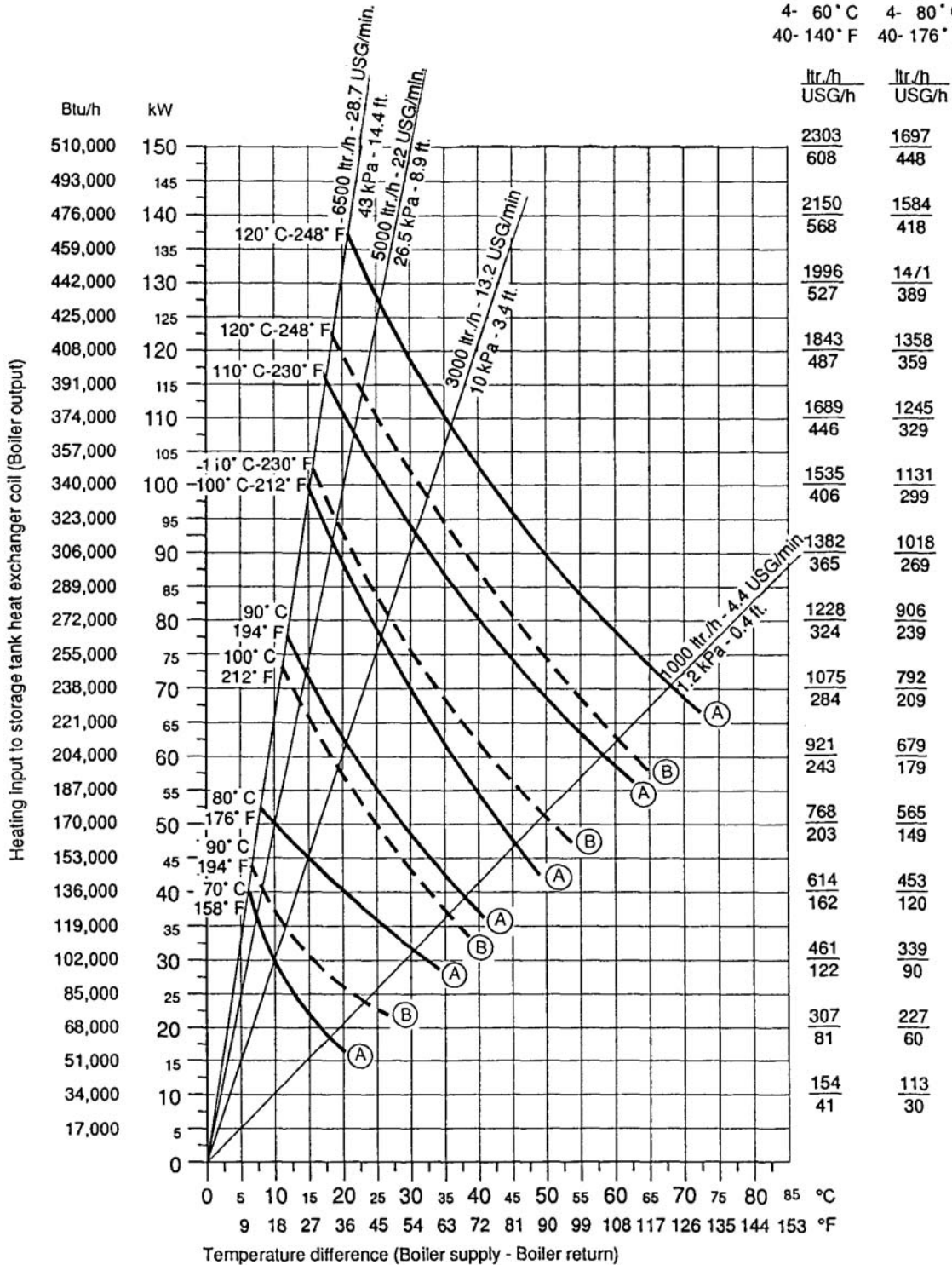

Water Flow *(continued)*

Example: Vitocell 300-V, 119 USG (450 L) capacity

Assume boiler output to tank is 238 MBH. Enter chart at left and draw horizontal line across to recovery rate of 284 GPH / 4.7 GPM for 140°F (60°C) domestic hot water under column A. Where the horizontal line intersects the 194°F (90°C) curve is the point of intersection for the diagonal line used to size the pump. The diagonal line begins at the origin and goes through the point of intersection extending to the top of the chart. Read between the reference diagonal lines to get a pump specification of 20 GPM at 8.4 ft. To summarize: For a Vitocell-V 300 with 119 USG (450 L) capacity and 238 MBH input, the boiler water temperature is 194°F (90°C), difference between boiler return and supply water temperature is 29°F (16°C), recovery rate is 4.7 GPM of 140°F (60°C) DHW, and the pump required is 20 GPM, 8.4 ft. plus pressure drop in piping and boiler. If a multiple-tank application is required, i.e. 4 tanks at 238 MBH input each, then the pump selection would be (4 x 20 GPM) 80 GPM at 8.4 ft. plus piping pressure drop.

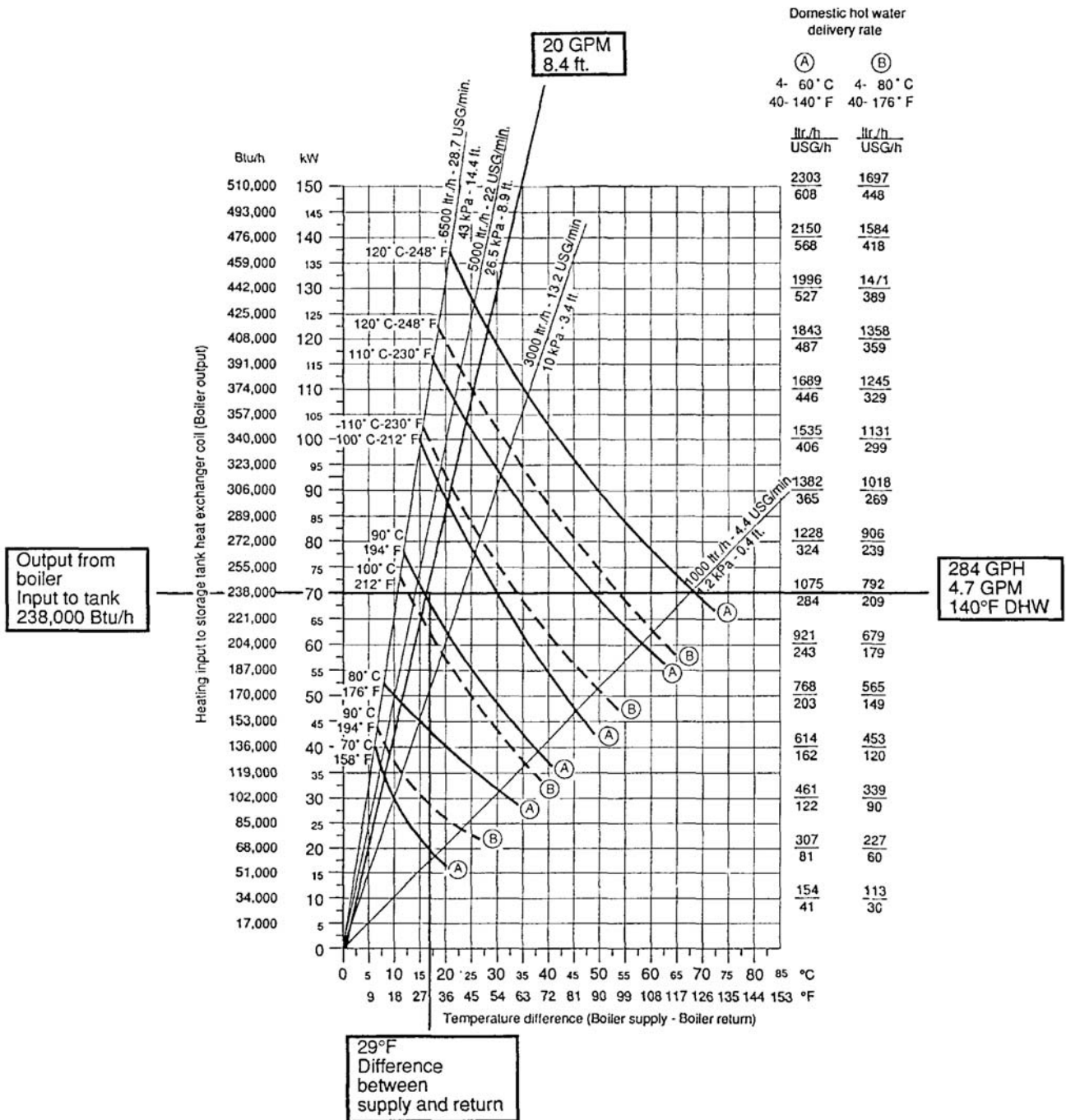

Standard Equipment

53 USG (200 L) and 79 USG (300 L) capacity

Domestic hot water tank of high-grade stainless steel with PUR Foam insulation with:

- thermometer and
- adjustable leveling bolts.

The following is packed separately and attached to the crate:

- installation fittings package: with the necessary brass adaptors, other necessary hardware
- sensor well with insulation
- temperature and pressure relief valve.

Electrostatically powder coated sheet metal enclosure panel in a Vitosilver finish.

119 USG (450 L) capacity

Domestic hot water tank of high-grade stainless steel with wrap-around PET insulation with:

- thermometer and
- adjustable leveling bolts.

The following is packed separately and attached to the crate:

- installation fittings package: with the necessary brass adaptors, other necessary hardware
- sensor well with insulation
- temperature and pressure relief valve.

Synthetic wrap-around enclosure panel in a Vitosilver finish.

IMPORTANT

This is a simplified conceptual drawing only!
Piping and necessary componentry must be field verified. Proper installation and functionality in the field is the responsibility of the heating contractor.

Domestic hot water connections

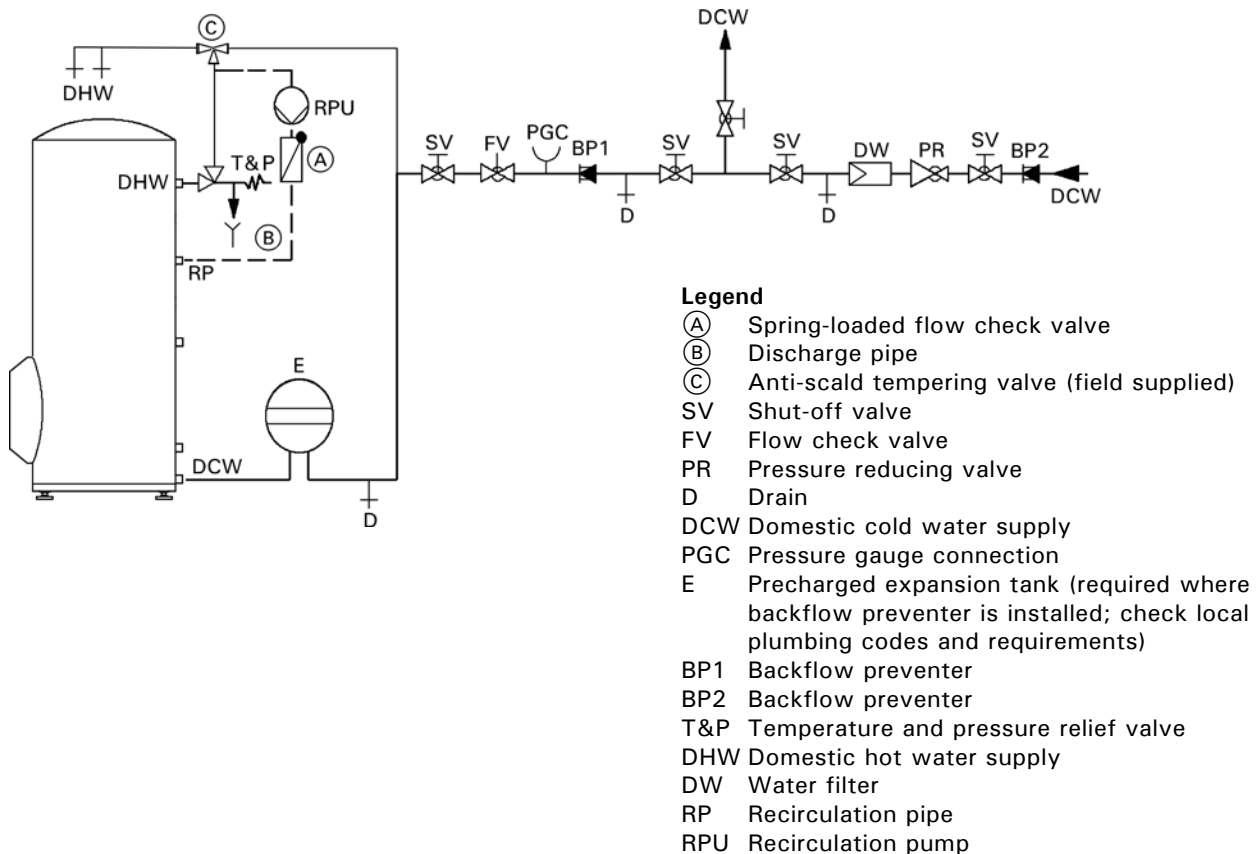

System Design Guidelines

Sensor well

The supplied stainless steel sensor wells are to be used for control sensors to ensure maximum operational safety. Should the supplied sensors not fit into the sensor wells, other stainless steel sensor wells must be used. For solar heating systems, Viessmann recommends placement of the DHW tank temperature sensor in the solar collector return. This requires a brass elbow with sensor well included in the accessory pack.

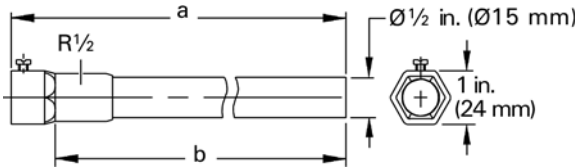

Storage capacity	USG (L)	53 (200)	79 (300)	119 (450)
a	in. (mm)	8 3/4 (220)	8 3/4 (220)	13 (330)
b	in. (mm)	7 3/4 (200)	7 3/4 (200)	12 1/4 (310)

WARNING

To ensure optimum, safe operation, the supplied stainless steel well must be installed. The well diameter is large enough to accommodate a wide variety of sensing bulbs. Always use spring clip to ensure proper contact of capillary bulb against the stainless steel well for proper sensing/heat transfer!

Heating water supply temperature over 230°F (110°C)

For these operating conditions, an approved high limit safety aquastat must be installed to limit the domestic hot water temperature to 203°F (95°C) in the tank.

Recirculation tapping

The recirculation tapping is on a separate tapping (see page 5). Cap this opening if the tank is not installed with recirculation.

Backflow preventers

Where backflow preventers are required, a domestic water expansion tank installation is recommended in the cold water inlet piping before the cold water enters the Vitocell. For the backflow device, observe local plumbing codes and regulations.

Temperature and pressure relief valve

A 150 psi temperature and pressure relief valve (T&P relief valve) is supplied with the tank. The heating contractor must install the valve on each tank in a method meeting code requirements. If local codes require a different relief valve, substitute the manufacturer's supplied valve. The tank is approved for 100 psig where a Canadian Registration Number (CRN) is required. Maximum operating pressure is 150 psig.

The T&P relief valve supplied with the tank is tested under ANSI Z21.22 Code for Relief Valves and Automatic Gas Shut-off Devices for Hot Water Supply Systems.

T&P Valve	100 psig (where CRN is required)	150 psig
ASME pressure steam rating	see ratings marked on T&P valve	
CSA temperature steam rating	205 MBH	205 MBH
Relief temperature	210°F (99°C)	210°F (99°C)
Inlet thread	3/4" male	3/4" male
Outlet thread	3/4" female	3/4" female

Warranty consideration

Viessmann DHW tanks require that the water heated should be of drinking water quality and that any water treatment equipment in use must function correctly.

If the product has been improperly installed or misapplied by the installer, contractor or final user, Viessmann accepts no responsibility for damage howsoever caused and reserves the right to withdraw the product warranty. In order to qualify for product warranty, strict adherence to the installation and service manuals must be observed.

In the event that components not approved by Viessmann are utilized, Viessmann reserves the right to withdraw all expressed or implied warranties without written notice.

The water to be heated with the Vitocell must be drinking (potable) water quality. If the tank is used to heat other media, the warranty will be null and void. Damage resulting from excessive pressure or temperature is clearly not the responsibility of Viessmann.

The amount of chloride and sulfate acceptable to the tank is limited. In areas where high concentrations of chloride and sulfate are present in drinking water, please consult Viessmann for directions.

For full warranty details, please read the product warranty sheet.

Printed on environmentally friendly
(recycled and recyclable) paper.



Technical information subject to change without notice.

Viessmann Manufacturing Company Inc.
750 McMurray Road
Waterloo, Ontario • N2V 2G5 • Canada
TechInfo Line 1-888-484-8643
1-800-387-7373 • Fax (519) 885-0887
www.viessmann.ca • info@viessmann.ca

Viessmann Manufacturing Company (U.S.) Inc.
45 Access Road
Warwick, Rhode Island • 02886 • USA
TechInfo Line 1-888-484-8643
1-800-288-0667 • Fax (401) 732-0590
www.viessmann-us.com • info@viessmann-us.com