

RE: INSTATEMENT **PERMIT ISSUED**

City of Portland, Maine - Building or Use Permit Application

389 Congress Street, 04101 Tel: (207) 874-8703, Fax: (207) 874-8716

Permit No: 01-0712	Issue Date: JUN 6 2002	CBL: 025 B005001
-----------------------	----------------------------------	---------------------

Location of Construction: 135 Marginal Way	Owner Name: Five Liver Company	Owned Address: 5 Milk Street, Portland, ME 04101	Phone: 207-7726404
Business Name: n/a	Contractor Name: Allied/Cook Construction Corp.	Contractor Address: PO Box 1396 Portland	Phone: 2077722888
Lessee/Buyer's Name: n/a	Phone: n/a	Permit Type: Commercial	Zone:

Past Use: Commercial/Retail	Proposed Use: Commercial/ Retail Office; Build new 88' x 198' Building, new parking lot, landscaping, curb cuts. Site Plan # 2000-0142.	Permit Fee: \$4,068.00	Cost of Work: \$674,000.00	CEO District: 1
---------------------------------------	---	----------------------------------	--------------------------------------	---------------------------

Proposed Project Description: Build new 88' x 198' Building	<table border="1" style="width: 100%; border-collapse: collapse;"> <tr> <td style="width: 50%; padding: 2px;">FIRE DEPT: <input type="checkbox"/> Approved <input type="checkbox"/> Denied <i>PREVIOUSLY APPROVED SEE ATTACHED</i></td> <td style="width: 50%; padding: 2px;">INSPECTION: Use Group: Type: <i>PREVIOUSLY APPROVED SEE ATTACHED</i></td> </tr> <tr> <td colspan="2" style="padding: 2px;">Signature:</td> </tr> </table>	FIRE DEPT: <input type="checkbox"/> Approved <input type="checkbox"/> Denied <i>PREVIOUSLY APPROVED SEE ATTACHED</i>	INSPECTION: Use Group: Type: <i>PREVIOUSLY APPROVED SEE ATTACHED</i>	Signature:	
FIRE DEPT: <input type="checkbox"/> Approved <input type="checkbox"/> Denied <i>PREVIOUSLY APPROVED SEE ATTACHED</i>	INSPECTION: Use Group: Type: <i>PREVIOUSLY APPROVED SEE ATTACHED</i>				
Signature:					

Permit Taken By: gg	Date Applied For: 06/06/2001	Zoning Approval
-------------------------------	--	------------------------

<ol style="list-style-type: none"> 1. This permit application does not preclude the Applicant(s) from meeting applicable State and Federal Rules. 2. Building permits do not include plumbing, septic or electrical work. 3. Building permits are void if work is not started within six (6) months of the date of issuance. False information may invalidate a building permit and stop all work.. 	<table border="1" style="width: 100%; border-collapse: collapse;"> <tr> <th style="text-align: left; padding: 2px;">Special Zone or Reviews</th> </tr> <tr> <td style="padding: 2px;"> <input type="checkbox"/> Shoreland <input type="checkbox"/> Wetland <input type="checkbox"/> Flood Zone <input type="checkbox"/> Subdivision <input type="checkbox"/> Site Plan Maj <input type="checkbox"/> Minor <input type="checkbox"/> MM <input type="checkbox"/> </td> </tr> <tr> <td style="padding: 2px;">Date: <i>PREVIOUSLY APPROVED</i></td> </tr> </table>	Special Zone or Reviews	<input type="checkbox"/> Shoreland <input type="checkbox"/> Wetland <input type="checkbox"/> Flood Zone <input type="checkbox"/> Subdivision <input type="checkbox"/> Site Plan Maj <input type="checkbox"/> Minor <input type="checkbox"/> MM <input type="checkbox"/>	Date: <i>PREVIOUSLY APPROVED</i>	<table border="1" style="width: 100%; border-collapse: collapse;"> <tr> <th style="text-align: left; padding: 2px;">Zoning Appeal</th> </tr> <tr> <td style="padding: 2px;"> <input type="checkbox"/> Variance <input type="checkbox"/> Miscellaneous <input type="checkbox"/> Conditional Use <input type="checkbox"/> Interpretation <input type="checkbox"/> Approved <input type="checkbox"/> Denied </td> </tr> <tr> <td style="padding: 2px;">Date:</td> </tr> </table>	Zoning Appeal	<input type="checkbox"/> Variance <input type="checkbox"/> Miscellaneous <input type="checkbox"/> Conditional Use <input type="checkbox"/> Interpretation <input type="checkbox"/> Approved <input type="checkbox"/> Denied	Date:	<table border="1" style="width: 100%; border-collapse: collapse;"> <tr> <th style="text-align: left; padding: 2px;">Historic Preservation</th> </tr> <tr> <td style="padding: 2px;"> <input type="checkbox"/> Not in District or Landmark <input type="checkbox"/> Does Not Require Review <input type="checkbox"/> Requires Review <input type="checkbox"/> Approved <input type="checkbox"/> Approved w/Conditions <input type="checkbox"/> Denied </td> </tr> <tr> <td style="padding: 2px;">Date:</td> </tr> </table>	Historic Preservation	<input type="checkbox"/> Not in District or Landmark <input type="checkbox"/> Does Not Require Review <input type="checkbox"/> Requires Review <input type="checkbox"/> Approved <input type="checkbox"/> Approved w/Conditions <input type="checkbox"/> Denied	Date:
Special Zone or Reviews												
<input type="checkbox"/> Shoreland <input type="checkbox"/> Wetland <input type="checkbox"/> Flood Zone <input type="checkbox"/> Subdivision <input type="checkbox"/> Site Plan Maj <input type="checkbox"/> Minor <input type="checkbox"/> MM <input type="checkbox"/>												
Date: <i>PREVIOUSLY APPROVED</i>												
Zoning Appeal												
<input type="checkbox"/> Variance <input type="checkbox"/> Miscellaneous <input type="checkbox"/> Conditional Use <input type="checkbox"/> Interpretation <input type="checkbox"/> Approved <input type="checkbox"/> Denied												
Date:												
Historic Preservation												
<input type="checkbox"/> Not in District or Landmark <input type="checkbox"/> Does Not Require Review <input type="checkbox"/> Requires Review <input type="checkbox"/> Approved <input type="checkbox"/> Approved w/Conditions <input type="checkbox"/> Denied												
Date:												

CERTIFICATION

I hereby certify that I am the owner of record of the named property, or that the proposed work is authorized by the owner of record and that I have been authorized by the owner to make this application as his authorized agent and I agree to conform to all applicable laws of this jurisdiction. In addition, if a permit for work described in the application is issued, I certify that the code official's authorized representative shall have the authority to enter all areas covered by such permit at any reasonable hour to enforce the provision of the code(s) applicable to such permit.

SIGNATURE OF APPLICANT	ADDRESS	DATE	PHONE
------------------------	---------	------	-------

RESPONSIBLE PERSON IN CHARGE OF WORK, TITLE	DATE	PHONE
---	------	-------

City of Portland, Maine - Building or Use Permit Application

389 Congress Street, 04101 Tel: (207) 874-8703, Fax: (207) 874-8716

Permit No: 01-0712	Issue Date: AUG 30	CBL: 025 B005001
-----------------------	------------------------------	---------------------

Location of Construction: 135 Marginal Way	Owner Name: Five Liver Company	Owner Address: 5 Milk St Portland, Me 04101	Phone: 207-7726404
Business Name: n/a	Contractor Name: Allied/Cook Construction Corp.	Contractor Address: PO Box 1396 Portland	Phone: 2077722888
Lessee/Buyer's Name: n/a	Phone: n/a	Permit Type: Additions - Commercial	Zone: B-5

Past Use: Commercial/Retail	Proposed Use: Commercial/ Retail Office; Build new 88' x 198' Building, new parking lot, landscaping, curb cuts.	Permit Fee: 406800	Cost of Work: \$674,000.00	CEO District: 1
---------------------------------------	--	------------------------------	--------------------------------------	---------------------------

Proposed Project Description: Build new 88' x 198' Building	FIRE DEPT: <input checked="" type="checkbox"/> Approved <input type="checkbox"/> Denied	INSPECTION: Use Group: Type: 2008/06/1999 PERMIT ISSUED WITH REQUIREMENTS
	Signature: <i>WMM</i>	Signature: <i>[Signature]</i>
	PEDESTRIAN ACTIVITIES DISTRICT (P.A.D.)	
	Action: <input type="checkbox"/> Approved <input type="checkbox"/> Approved w/Conditions <input checked="" type="checkbox"/> Denied	
	Signature:	Date:

Permit Taken By: gg	Date Applied For: 06/06/2001	Zoning Approval	
-------------------------------	--	------------------------	--

<ol style="list-style-type: none"> This permit application does not preclude the Applicant(s) from meeting applicable State and Federal Rules. Building permits do not include plumbing, septic or electrical work. Building permits are void if work is not started within six (6) months of the date of issuance. False information may invalidate a building permit and stop all work.. 	Special Zone or Reviews <input type="checkbox"/> Shoreland <i>N/A</i> <input type="checkbox"/> Wetland <input type="checkbox"/> Flood Zone <i>April 13 zone C</i> <input type="checkbox"/> Subdivision <input checked="" type="checkbox"/> Site Plan #2000-0142 Maj <input checked="" type="checkbox"/> Minor <input type="checkbox"/> MM <input type="checkbox"/> Date: <i>OK with conditions</i>	Zoning Appeal <input type="checkbox"/> Variance <input type="checkbox"/> Miscellaneous <input type="checkbox"/> Conditional Use <input type="checkbox"/> Interpretation <input type="checkbox"/> Approved <input type="checkbox"/> Denied Date:	Historic Preservation <input checked="" type="checkbox"/> Not in District or Landmark <input type="checkbox"/> Does Not Require Review <input type="checkbox"/> Requires Review <input type="checkbox"/> Approved <input type="checkbox"/> Approved w/Conditions <input type="checkbox"/> Denied Date: <i>9</i>
---	--	---	---

*20 June 10/1 @ 7:50 AM called contractor regarding the permit and the info. I needed. *[Signature]* 7/2/01*

PERMIT ISSUED WITH REQUIREMENTS

CERTIFICATION

I hereby certify that I am the owner of record of the named property, or that the proposed work is authorized by the owner of record and that I have been authorized by the owner to make this application as his authorized agent and I agree to conform to all applicable laws of this jurisdiction. In addition, if a permit for work described in the application is issued, I certify that the code official's authorized representative shall have the authority to enter all areas covered by such permit at any reasonable hour to enforce the provision of the code(s) applicable to such permit.

SIGNATURE OF APPLICANT	ADDRESS	DATE	PHONE
------------------------	---------	------	-------

RESPONSIBLE PERSON IN CHARGE OF WORK, TITLE	DATE	PHONE
---	------	-------

2000-0142

THIS IS NOT A PERMIT/CONSTRUCTION CANNOT COMMENCE UNTIL THE PERMIT IS ISSUED

All Purpose Building Permit Application

If you or the property owner owes real estate or personal property taxes or user charges on any property within the City, payment arrangements must be made before permits of any kind are accepted.

Location/Address of Construction: 135 MARGINAL WAY

Total Square Footage of Proposed Structure 18,000 SF +/- Square Footage of Lot 62,700 +/- SF

Tax Assessor's Chart, Block & Lot Number Chart# 025 Block# B Lot# 5
Owner: FIVE LIVER COMPANY Telephone#: 772-6404

Lessee/Buyer's Name (If Applicable) Owner's/Purchaser/Lessee Address: P.O. Box 7525 PORTLAND, ME 04112
Cost Of Work: \$674,000 Fee: \$4,068.

Current use: RETAIL
If the location is currently vacant, what was prior use:
Approximately how long has it been vacant:
Proposed use: RETAIL / OFFICE 18,000 SF 88 x 198 Bldg.
Project description: ~~DEMOLISH EXISTING STRUCTURE~~, BUILD NEW (1) STORY BUILDING, NEW PARKING LOT, LANDSCAPING, CURB CUTS, UTILITIES.

Contractor's Name, Address & Telephone: 772-2888 ALLIED/COOK CONSTRUCTION P.O. Box 1396 PORTLAND ME 04104
Applicants Name, Address & Telephone: BRUCE KETTLER P.O. Box 7525; PORTLAND, ME 04112
Who should we contact when the permit is ready: BRUCE KETTLER
Telephone: 772-8286 ext 207 call
If you would like the permit mailed, what mailing address should we use: FIVE LIVER COMPANY P.O. Box 7525 PORTLAND, ME 04112 Rec'd By:
will email Plans

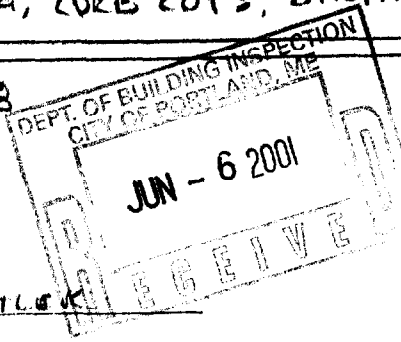

6/6/01
Coff

Paul - Rick Knokland approved
written

Gay 16

025-B-005

Site Review Pre-Application Multi-Family/Attached Single Family Dwellings/Two-Family Dwelling or Commercial Structures and Additions Thereto

In the interest of processing your application in the quickest possible manner, please complete the Information below for Site Plan Review

NOTEIf you or the property owner owes real estate or personal property taxes or user charges on ANY PROPERTY within the City, payment arrangements must be made before permits of any kind are accepted.**

FIVE LIVER COMPANY
Applicant

Application Date
7/11/00

P.O. Box 7525
Applicant's Mailing Address
PORTLAND, ME 04112

Project Name/Description
135 MARGINAL WAY

FORE RIVER COMPANY
Consultant/Agent

Address Of Proposed Site
135 MARGINAL WAY

Applicant/Agent Daytime telephone and FAX

Assessor's Reference, Chart#, Block, Lot# 25-B-1,5,6,22
Portions of

Proposed Development (Check all that apply) New Building Building Addition Change of Use Residential Office Retail
 Manufacturing Warehouse/Distribution Other(Specify) _____

13,000 +/-
Proposed Building Square Footage and /or # of Units

1.44 Acres +/-
Acreage of Site

B5
\$500.00

You must include the following with you application:

- 1) A Copy of Your Deed or Purchase and Sale Agreement
 - 2) 7 sets of Site Plan packages containing the information found in the attached sample plans and checklist. 2 extra Site Plans
- (Section 14-522 of the Zoning Ordinance outlines the process, copies are available for review at the counter, photocopies are \$ 0.25 per page)

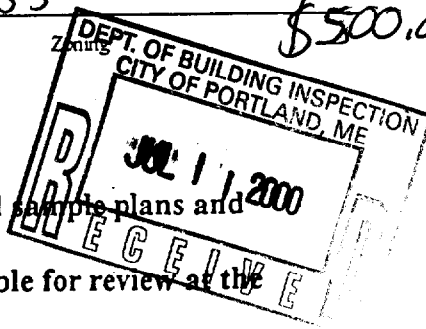

I hereby certify that I am the Owner of record of the named property, or that the proposed work is authorized by the owner of record and that I have been authorized by the owner to make this application as his/her authorized agent. I agree to conform to all applicable laws of this jurisdiction. In addition, if an approval for the proposed project or use described in this application is issued, I certify that the Code Official's authorized representative shall have the authority to enter all areas covered by this approval at any reasonable hour to enforce the provisions of the codes applicable to this approval.

Signature of applicant: <u>Bruce Kiser</u>	Date: <u>7/11/00</u>
--	----------------------

Site Review Fee: Major \$500.00 Minor 400.00

This application is for site review ONLY, a Building Permit application and associated fees will be required prior to construction.

BUILDING PERMIT REPORT

DATE: 20 June 2001 ADDRESS: 135 Marginal Way CBL: 025-B-005
 REASON FOR PERMIT: To Construct an 88' x 198' shell only bldg.
 BUILDING OWNER: Five Live Company
 PERMIT APPLICANT: _____ CONTRACTOR: Allied Rock Co. S.Y.
 USE GROUP: M/B CONSTRUCTION TYPE: 2C CONSTRUCTION COST: 674,000 PERMIT FEES: 4,068

The City's Adopted Building Code (The BOCA National Building Code/1999 with City Amendments)
 The City's Adopted Mechanical Code (The BOCA National Mechanical Code/1993)

CONDITION(S) OF APPROVAL

This permit is being issued with the understanding that the following conditions shall be met: #1, #2, #3, #5, #6, #28, #30, #36, #38, #39, #32

1. This permit does not excuse the applicant from meeting applicable State and Federal rules and laws.
2. Before concrete for foundation is placed, approvals from the Development Review Coordinator and Inspection Services must be obtained. (A 24 hour notice is required prior to inspection) **"ALL LOT LINES SHALL BE CLEARLY MARKED BEFORE CALLING."**
3. Foundation drain shall be placed around the perimeter of a foundation that consists of gravel or crushed stone containing not more than 10 percent material that passes through a No. 4 sieve. The drain shall extend a minimum of 12 inches beyond the outside edge of the footing. The thickness shall be such that the bottom of the drain is not higher than the bottom of the base under the floor, and that the top of the drain is not less than 6 inches above the top of the footing. The top of the drain shall be covered with an approved filter membrane material. Where a drain tile or perforated pipe is used, the invert of the pipe or tile shall not be higher than the floor elevation. The top of joints or top of perforations shall be protected with an approved filter membrane material. The pipe or tile shall be placed on not less than 2" of gravel or crushed stone, and shall be covered with not less than 6" of the same material. Section 1813.5.2
4. Foundations anchors shall be a minimum of 1/2" in diameter, 7" into the foundation wall, minimum of 12" from corners of foundation and a maximum 6' O.C. between bolts. Section 2305.17
5. Waterproofing and dampproofing shall be done in accordance with Section 1813.0 of the building code.
6. Precaution must be taken to protect concrete and masonry. Concrete Sections 1908.9-19.8.10/ Masonry Sections 2111.3-2111.4.
7. It is strongly recommended that a registered land surveyor check all foundation forms before concrete is placed. This is done to verify that the proper setbacks are maintained.
8. Private garages located beneath habitable rooms in occupancies in Use Group R-1, R-2, R-3 or I-1 shall be separated from adjacent interior spaces by fire partitions and floor/ceiling assembly which are constructed with not less than 1-hour fire resisting rating. Private garages attached side-by-side to rooms in the above occupancies shall be completely separated from the interior spaces and the attic area by means of 1/2 inch gypsum board or the equivalent applied to the garage side. (Chapter 4, Section 407.0 of the BOCA/1999)
9. All chimneys and vents shall be installed and maintained as per Chapter 12 of the City's Mechanical Code. (The BOCA National Mechanical Code/1993). Chapter 12 & NFPA 211
10. Sound transmission control in residential building shall be done in accordance with Chapter 12, Section 1214.0 of the City's Building Code.
11. Guardrails & Handrails: A guardrail system is a system of building components located near the open sides of elevated walking surfaces for the purpose of minimizing the possibility of an accidental fall from the walking surface to the lower level. Minimum height all Use Groups 42". In occupancies in Use Group A, B.H-4, I-1, I-2, M, R, public garages and open parking structures, open guards shall have balusters or be of solid material such that a sphere with a diameter of 4" cannot pass through any opening. Guards shall not have an ornamental pattern that would provide a ladder effect. Handrails shall be a minimum of 34" but not more than 38". Exception: Handrails that form part of a guard shall have a height not less than 36 inches (914 mm) and not more than 42 inches (1067 mm). Handrail grip size shall have a circular cross section with an outside diameter of at least 1 1/4" and not greater than 2". (Sections 1021 & 1022.0). Handrails shall be on both sides of stairway. (Section 1014.7)
12. Headroom in habitable space is a minimum of 7'6". (Section 1204.0)
13. Stair construction in Use Group R-3 & R-4 is a minimum of 10" tread and 7 3/4" maximum rise. All other Use Group minimum 11" tread, 7" maximum rise. (Section 1014.0)
14. The minimum headroom in all parts of a stairway shall not be less than 80 inches. (6'8") 1014.4
15. The Minimum required width of a corridor shall be determined by the most restrictive of the criteria under section 1011.3 but not less than 36".
16. Every sleeping room below the fourth story in buildings of Use Groups R and I-1 shall have at least one operable window or exterior door approved for emergency egress or rescue. The units must be operable from the inside without the use of special knowledge or separate tools. Where windows are provided as means of egress or rescue they shall have a sill height not more than 44 inches (1118mm) above the floor. All egress or rescue windows from sleeping rooms shall have a minimum net clear opening height dimension of 24 inches (610mm). The minimum net clear opening width dimension shall be 20 inches (508mm), and a minimum net clear opening of 5.7 sq. ft. (Section 1010.4)
17. Each apartment shall have access to two (2) separate, remote and approved means of egress. A single exit is acceptable when it exits directly from the apartment to the building exterior with no communications to other apartment units. (Section 1010.1)
18. All vertical openings shall be enclosed with construction having a fire rating of at least one (1) hour, including fire doors with self closure's. (Over 3 stories in height requirements for fire rating is two (2) hours. (Section 710.0)
19. The boiler shall be protected by enclosing with (1) hour fire rated construction including fire doors and ceiling, or by providing automatic extinguishment. (Table 302.1.1)

6/6/01

20. All single and multiple station smoke detectors shall be of an approved type and shall be installed in accordance with the provisions of the City's Building Code Chapter 9, Section 920.2 (BOCA National Building Code/1999), and Chapter 10 & 11. (Smoke detectors shall be installed and maintained at the following locations):

- In the immediate vicinity of bedrooms
- In all bedrooms
- In each story within a dwelling unit, including basements

21. A portable fire extinguisher shall be located as per NFPA #10. They shall bear the label of an approved agency and be of an approved type. (Section 921.0)

22. The Fire Alarm System shall be installed and maintained to NFPA #72 Standard.

23. The Sprinkler System shall be installed and maintained to NFPA #13 Standard.

24. All exit signs, lights and means of egress lighting shall be done in accordance with Chapter 10 Section & Subsections 1023.0 & 1024.0 of the City's Building Code. (The BOCA National Building Code/1999)

25. Section 25 - 135 of the Municipal Code for the City of Portland states, "No person or utility shall be granted a permit to excavate or open any street or sidewalk from the time of November 15 of each year to April 15 of the following year".

26. The builder of a facility to which Section 4594-C of the Maine State Human Rights Act Title 5 MRSA refers, shall obtain a certification from a design professional that the plans commencing construction of the facility, the builder shall submit the certification the Division of Inspection Services.

27. Ventilation and access shall meet the requirements of Chapter 12 Sections 1210.0 and 1211.0 of the City's Building Code. (Crawl spaces & attics).

* 28. All electrical, plumbing and HVAC permits must be obtained by Master Licensed holders of their trade. No closing in of walls until all electrical (min. 72 hours notice) and plumbing inspections have been done.

29. All requirements must be met before a final Certificate of Occupancy is issued.

30. All building elements shall meet the fastening schedule as per Table 2305.2 of the City's Building Code (The BOCA National Building Code/1996).

31. Ventilation of spaces within a building shall be done in accordance with the City's Mechanical code (The BOCA National Mechanical Code/1993). (Chapter M-16)

32. Please read and implement the attached Land Use Zoning report requirements. *All the conditions and requirements on the attached site development sheets shall be met*

33. Boring, cutting and notching shall be done in accordance with Sections 2305.3, 2305.3.1, 2305.4.4 and 2305.5.1 of the City's Building Code.

34. Bridging shall comply with Section 2305.16.

35. Glass and glazing shall meet the requirements of Chapter 24 of the building code. (Safety Glazing Section 2406.0)

36. All flashing shall comply with Section 1406.3.10.

37. All signage shall be done in accordance with Section 3102.0 signs of the City's Building Code, (The BOCA National Building Code/1999).

* ~~38. Find attached (3) three construction documents that shall be completed by the professional designer~~

* ~~39. This permit is for the shell only of this bldg. a separate permit is required to finish this bldg.~~

* ~~46. This project will require State Fire Marshal's Office approval~~

* ~~41. This proposed project will also require special inspection as per section 1705.0 (see attached)~~

[Signature]
 Samuel Hoffses, Building Inspector
 Cf. L. McDougall, PFD
 Marge Schmuckal, Zoning Administrator
 Michael Nugent, Inspection Service Manager
26414

PSH 10/1/00

**This permit is herewith issued, on the basis of plans submitted and conditions placed on these plans, any deviations shall require a separate approval.

***THIS PERMIT HAS BEEN ISSUED WITH THE UNDERSTANDING THAT ALL THE CONDITIONS OF THE APPROVAL SHALL BE COMPLETED. THEREFORE, BEFORE THE WORK IS COMPLETED A REVISED PLAN OR STATEMENT FROM THE PERMIT HOLDER SHALL BE SUBMITTED TO THIS OFFICE SHOWING OR EXPLAINING THAT THE CONDITIONS HAVE BEEN MET. IF THIS REQUIREMENT IS NOT RECEIVED YOUR CERTIFICATE OF OCCUPANCY SHALL BE WITHHELD. (You Shall Call for Inspections)

****ALL PLANS THAT REQUIRE A PROFESSIONAL DESIGNER'S SEAL, (AS PER SECTION 114.0 OF THE BUILDING CODE) SHALL ALSO BE PRESENTED TO THIS DIVISION ON AUTO CAD LT. 2000, DXF FORMAT OR EQUIVALENT.

*****CERTIFICATE OF OCCUPANCY FEE \$50.00

NOTES: N.R. — Not required
N.A. — Not applicable

ADMINISTRATION (Chapter 1)

NO Complete construction documents (107.5, 107.6, 107.7) yes Signed/sealed construction documents (107.7, 114.1)
Shell of bldg. only

BUILDING PLANNING (Chapters 3, 4, 5, 6)

USE OR OCCUPANCY CLASSIFICATION (302.0-313.0)

✓ Single Use Group NO Specific occupancy areas (302.1.1)
NA Mixed Use Groups NA Accessory areas (302.1.2)

GENERAL BUILDING LIMITATIONS (Chapters 5 & 6)

Apply Case 1 to determine the allowable height and area and permitted types of construction for a building containing a single use group or nonseparated mixed use groups. Apply Case 2 to determine the allowable height and area and permitted types of construction for a building containing separated mixed use groups.

AREA MODIFICATIONS TO TABLE 503

% of Allowable tabular area (Table 503)	<u>100%</u>
% Reduction for height (Table 506.4)	<u>- 0%</u>
% Increase for open perimeter (506.2)	<u>+ 150%</u>
% Increase for automatic sprinklers (506.3)	<u>+ 200%</u>
Total percentage factor	<u>= 350%</u>
Conversion factor	<u>$\frac{350\%}{100\%} = 3.50$</u> (Total percentage factor/100%)

Open perimeter (506.2)	<u>198</u> North	<u>88</u> East	<u>198</u> South	<u>88</u> West
Open perim. <u>572</u> ft.	Perimeter <u>572</u> ft.			
% Open perimeter =	$\frac{(572/572) \times 100\%}{(Open\ perim./perim.) \times 100\%} = 100$			
% Tab. area increase = (506.2)	$\frac{100 - 25 = 150\%}{2 \times (\% Open\ perim. - 25\%)} = 150\%$			

CASE 1 — SINGLE USE OR NONSEPARATED MIXED USE GROUPS (313.1.1, 503.0)

Using Table 503, identify the allowable height and area of the single use group or the most restrictive of the nonseparated mixed use groups. Construction types that provide an allowable tabular area equal to or greater than the adjusted floor area and allowable heights (as modified by Section 504.0) equal to or greater than the actual building height are permitted.

Actual floor area <u>17,424</u> ft. ²		Actual building height <u>20</u> feet	1 stories
Adjusted floor area* <u>4978</u> ft. ²		Allowable building height <u>30</u> feet	2 stories

*Adjusted floor area = actual floor area/conversion factor

Permitted types of construction 5A Type of construction assumed for review (602.3) 2C

CASE 2 — MIXED USE SEPARATED USE GROUPS

Using Table 503, identify the allowable height and area of each of the separated use groups within the building. Construction types that provide, for each story of the building, tabular areas which result in a sum of the ratios of 1.00 or less and allowable heights (as modified by Section 504.0) equal to or greater than the actual height of the use group are permitted.

Story	Use Group	Actual floor area	Adjusted floor area*	Actual height	Allowable height (Table 503)
_____	_____	_____ ft ²	_____ ft ²	_____ ft _____ stories	_____ ft _____ stories
_____	NA/A	_____ ft ²	_____ ft ²	_____ ft _____ stories	_____ ft _____ stories
_____		_____ ft ²	_____ ft ²	_____ ft _____ stories	_____ ft _____ stories
_____		_____ ft ²	_____ ft ²	_____ ft _____ stories	_____ ft _____ stories
_____		_____ ft ²	_____ ft ²	_____ ft _____ stories	_____ ft _____ stories
_____		_____ ft ²	_____ ft ²	_____ ft _____ stories	_____ ft _____ stories
_____		_____ ft ²	_____ ft ²	_____ ft _____ stories	_____ ft _____ stories
_____		_____ ft ²	_____ ft ²	_____ ft _____ stories	_____ ft _____ stories
_____		_____ ft ²	_____ ft ²	_____ ft _____ stories	_____ ft _____ stories

*Adjusted floor area = actual floor area/conversion factor

$$\sum \frac{\text{Adjusted floor area}^*}{\text{Allowable area (Table 503)}} = \underline{\quad} + \underline{\quad} + \underline{\quad} + \underline{\quad} = \underline{\quad} \leq 1.00$$

Permitted types of construction _____ Type of construction assumed for review (602.3) _____

UNLIMITED AREA ONE-STORY BUILDINGS

- M Use group classification (507.1) _____ School buildings (507.1.1)
- _____ Building height (story, feet) (507.1) _____ High-hazard use groups (507.1.2)
- 2C Type of construction (507.1) _____ Exterior walls (507.2)
- _____ Automatic sprinkler system (507.1, 904.11)

MEZZANINES

- NA Area limitation (505.2) NA Openness (505.4)
- NA Egress (505.3)

SPECIAL USE AND OCCUPANCY (Chapter 4)

COVERED MALL BUILDINGS

- NA Tenant separations (402.4)
- _____ Egress (402.5)
- _____ Mall width (402.6)
- _____ Structural elements (402.7)
- _____ Roof coverings (402.8)
- _____ A-1, A-2 occupancy (402.9)
- _____ Automatic sprinkler system (402.10)
- _____ Standpipes (402.11)
- _____ Fire department access (402.12)
- _____ Kiosk requirements (402.14)

- 1 Parking structures (402.15)

HIGH-RISE BUILDINGS

- NA Automatic sprinkler system (403.2)
- _____ Alternative sprinkler modifications (403.3)
- _____ Automatic fire detection (403.4)
- _____ Voice/alarm signaling systems (403.5)
- _____ Fire department communication (403.6)
- _____ Fire command station (403.7)
- _____ Elevators (403.8)
- _____ Standby systems (403.9)
- _____ Stairway doors (403.10)

ATRIUMS

- _____ Automatic sprinkler system (404.2)
- _____ Occupancy (404.3)
- _____ Smoke control (404.4)
- _____ Enclosure (404.5)
- _____ Fire alarm system (404.6)
- _____ Travel distance (404.7)

OTHER SPECIAL USE AND OCCUPANCY

- NA _____ Underground structures (405.0)
- _____ Open parking structures (406.0)

- _____ Private garages (407.0)
- _____ Public garages (408.0)
- _____ Use Group I-2 (409.0)
- _____ Use Group I-3 (410.0)
- _____ Stages and platforms (412.0)
- _____ Special amusement buildings (413.0)
- _____ HPM facilities (416.0)
- _____ Hazardous materials (307.8, 417.0)
- _____ Use Groups H-1, H-2, H-3 and H-4 (418.0)
- _____ Swimming pools (421.0)

FIRE PROTECTION (Chapters 6, 7, 8, 9)

FIRERESISTANT MATERIALS AND CONSTRUCTION (Chapter 7 and Table 602)

Note: Entry in indicates required rating in hours. NC indicates noncombustible construction required.

COMBUSTIBILITY (603.0, 604.0, 605.0, 606.0)

- NC _____ Exterior walls
- NA _____ Interior elements
- NA _____ Roof

CONSTRUCTION DOCUMENTS (703.0)

- NA _____ Fire tests (704.0)

EXTERIOR WALLS (507.2, 705.0, 716.5)

	North	East	South	West
Fire separation distance	<u>50'</u>	<u>50'</u>	<u>50'</u>	<u>50'</u>
Loadbearing	<input type="checkbox"/>	<input checked="" type="checkbox"/>	<input type="checkbox"/>	<input checked="" type="checkbox"/>
Nonloadbearing	<input checked="" type="checkbox"/>	<input type="checkbox"/>	<input checked="" type="checkbox"/>	<input type="checkbox"/>

- Ø _____ Exterior opening protectives (705.3, 706.0)
- Ø _____ Parapet walls (705.6)

FIRE SEPARATION ASSEMBLIES *Shell of bldg. on this permit*

- _____ Exit enclosures (709.0, 710.0, 1014.11)
- _____ Other shafts (709.0, 710.0)
- _____ Mixed use and fire area separations (313.1.2)
- _____ Other separation assemblies (302.1.1, Table 602)

FIRE PARTITIONS

- _____ Exit access corridors (711.0, 1011.4)
- _____ Tenant separations (711.0)
- _____ Dwelling unit separations (711.0)
- _____ Guestroom separations (711.0)

OTHER FIRERESISTANT CONSTRUCTION

- _____ Fire and party walls (707.0 and Table 707.1)
- _____ Smoke barriers (712.0)
- _____ Nonloadbearing partitions (Table 602)
- _____ Interior loadbearing walls, columns, girders, trusses (716.0)
- _____ Supporting construction (716.0)
- _____ Floor construction (713.0, 1006.3.1)
- _____ Roof construction (713.0, 715.0)
- _____ Penetrations (714.0)
- _____ Opening protectives (717.0, 719.0, 720.0)
- _____ Fire dampers (718.0)
- _____ Fireblocking/draftstopping (721.0)
- _____ Thermal and sound-insulating materials (723.0)

INTERIOR FINISHES (Chapter 8)

_____ Smoke development (803.3.2)
 _____ Flame spread (803.4)

_____ Floor finish (805.0, 806.0)

FIRE PROTECTION SYSTEMS (Chapter 9)

FIRE SUPPRESSION SYSTEMS (Where required)

NA Assembly (A-1, A-3, A-4) (904.2)
NA Assembly (A-2) (904.3)
NA Educational (E) (904.4)
NA High-hazard (H) (904.5)
NA Institutional (I) (904.6)
 _____ Mercantile (M), Moderate-hazard storage (S-1), Factory and Industrial (F-1) (904.7)
NA Residential (R-1) (904.8)
NA Residential (R-2) (904.9)
NA Windowless story (904.10)
 _____ Specific occupancy areas (302.1.1, 904.11)
 _____ Covered mall buildings (402.10)
NA High-rise buildings (403.2)
NA Atriums (404.2)
NA Underground structures (405.3)
NA Public garages (408.3.1)
NA Sound stages (411.7)
NA Stages and enclosed platforms (412.6)
NA Special amusement buildings (413.4)
NA HPM facilities (416.4)
NA Paint spray booths and storage rooms (419.3)
1 Unlimited area buildings (507.1)
MA Exit lobbies (1020.3)
NA Drying rooms (2806.4)
NA Waste- and linen-chutes/termination rooms (2807.6)
MA Refuse vaults (2808.4)

FIRE SPRINKLER SYSTEMS

_____ NFPA 13 system (906.2.1)
 _____ NFPA 13R system (906.2.2)
 _____ NFPA 13D system (906.2.3)
 _____ Design (906.3)
 _____ Actuation (906.4)
 _____ Sprinkler alarms (906.5)
 _____ Sprinkler riser (906.7)

LIMITED AREA SPRINKLER SYSTEMS

NA Where permitted (907.2)
 _____ Design (907.3)
 _____ Actuation (907.4)
 _____ Standpipe connection (907.6)
 _____ Domestic supply (907.6.1)
 _____ Cross connection (907.6.2)
 _____ Shutoff valve (907.6.3)

OTHER SUPPRESSION SYSTEMS

NA Water-spray fixed systems (908.0)
 _____ Carbon dioxide extinguishing systems (909.0)
 _____ Dry-chemical extinguishing systems (910.0)
 _____ Foam-extinguishing systems (911.0)
 _____ Halogenated extinguishing systems (912.0)
 _____ Clean agent fire extinguishing systems (913.0)
 _____ Wet-chemical range hood extinguishing systems (914.0)

STANDPIPE SYSTEMS

- _____ Building height (915.2.1)
- _____ Building area (915.2.2)
- / _____ Malls (915.2.3)
- _____ Stages (915.2.4)
- _____ Approved system (915.3, 915.3.1)
- _____ Piping design (915.4)
- _____ Water supply (915.5)
- _____ Control valves (915.6)
- _____ Hose connection (915.7)

FIRE DEPARTMENT CONNECTIONS

- _____ Required (916.1)
- _____ Connections (916.2)

YARD HYDRANTS

- _____ Fire hydrants (917.1)

FIRE ALARM SYSTEMS

- _____ Approval (918.3)
- _____ Assembly (A-4), Educational (E) (918.4.1)
- _____ Business (B)(918.4.2)
- _____ High-hazard (H) (918.4.3)
- _____ Institutional (I) (918.4.4)
- _____ Residential (R-1) (918.4.5)
- _____ Residential (R-2) (918.4.6)
- _____ Location/details (918.5)
- _____ Power supply/wiring (918.6, 918.7)
- _____ Alarm-notification appliances (918.8)
- _____ Voice/alarm signaling system (918.9)

AUTOMATIC FIRE DETECTION SYSTEMS

- _____ Approval (919.3)
- _____ Institutional (I) (919.4.1, 919.4.2, 919.4.3)
- _____ Residential (R-1) (919.4.4)
- _____ Sprinklered buildings exception (919.5)
- _____ Zones (919.6)

SINGLE- AND MULTIPLE-STATION SMOKE DETECTORS

- NA _____ Residential (R-1) (920.3.1)
- _____ Residential (R-2, R-3) (920.3.2)
- _____ Institutional (I-1) (920.3.3)
- _____ Interconnection (920.4)
- _____ Battery backup (920.5)

FIRE EXTINGUISHERS

- _____ Approval (921.1)
- _____ Required (921.2)

SMOKE CONTROL SYSTEMS

- _____ Passive system (922.2.1)
- _____ Mechanical system (922.2.2)
- _____ Smoke removal (922.3)
- _____ Activation (922.4)
- _____ Standby power (922.5)

SMOKE AND HEAT VENTS

- _____ Size and spacing (923.2)

SUPERVISION

- _____ Fire suppression systems (924.1)
- _____ Fire alarm systems (924.2)

MEANS OF EGRESS (continued)

_____	General limitations (1005.0)	_____	Ramps (1016.0)
_____	Air movement in egress elements (1005.7)	_____	Means of egress doorways (1017.0)
_____	Types and location of egress (1006.0)	_____	Number of doorways (1017.2)
_____	Exit access travel distance (1006.5 and Table 1006.5)	_____	Size of doors (1017.3)
_____	Accessible means of egress (1007.0)	_____	Door hardware (1017.4)
_____	Emergency escape (1010.4)	_____	Revolving doors (1018.0)
_____	Exit access passageways and corridors (1011.0)	_____	Horizontal exits (1019.0)
_____	Aisles and accessways (1012.0)	_____	Level of exit discharge passageway (1020.0)
_____	Grandstands (1013.0)	_____	Guards (1021.0)
_____	Interior stairways (1014.1 - 1014.11)	_____	Handrails (1022.0)
_____	Exterior stairways (1014.1 - 1014.10, 1014.12)	_____	Exit signs and lights (1023.0)
_____	Smokeproof enclosures (1015.0)	_____	Means of egress lighting (1024.0)
		_____	Access to roof (1027.0)

ACCESSIBILITY (Chapter 11)

_____	Required (1103.0)	_____	Accessible entrances (1106.0)
_____	Accessible route (1104.0)	_____	Special use groups (1107.0)
_____	Parking facilities (1105.0)	_____	Features and facilities (1108.0)

INTERIOR ENVIRONMENT (Chapter 12)

_____	Room dimensions (1204.0)	_____	Air-borne noise (STC) (1214.2)
_____	Roof spaces (1210.1, 1211.2)	_____	Structure-borne sound (IIC) (1214.3)
_____	Crawl spaces (1210.2, 1211.1)	_____	Ratproofing (1215.0)

BUILDING ENVELOPE (Chapters 14, 15)

EXTERIOR WALL COVERINGS (Chapter 14)

_____	Performance requirements (1403.0)	_____ <i>NA</i>	Combustible material restrictions (1406.0)
_____ <i>k</i>	Wall sidings and veneers (1404.0, 1405.0)		

ROOFS AND ROOF STRUCTURES (Chapter 15)

_____	Performance requirements (1505.0)	_____	Low-slope roof coverings (1507.5)
_____	Fire classification (1506.0)	_____	Flashing (1508.0)
_____	Steep-slope roof coverings (1507.4)	_____	Roof structures (1510.0)

STRUCTURAL SYSTEMS (Chapters 16, 17, 18)

STRUCTURAL LOADS (Chapter 16)

<p>DESIGN LOADS ON CONSTRUCTION DOCUMENTS (1603.1)</p> <p>Uniformly distributed floor live loads (1603.2, 1606.0)</p> <table style="width: 100%; border-collapse: collapse; margin-top: 10px;"> <thead> <tr> <th style="width: 50%; text-align: center;">Floor Area Use</th> <th style="width: 50%; text-align: center;">Loads Shown</th> </tr> </thead> <tbody> <tr><td style="border-bottom: 1px solid black;">_____</td><td style="border-bottom: 1px solid black;">_____</td></tr> <tr><td style="border-bottom: 1px solid black;">_____</td><td style="border-bottom: 1px solid black;">_____</td></tr> <tr><td style="border-bottom: 1px solid black;">_____</td><td style="border-bottom: 1px solid black;">_____</td></tr> <tr><td style="border-bottom: 1px solid black;">_____</td><td style="border-bottom: 1px solid black;">_____</td></tr> <tr><td style="border-bottom: 1px solid black;">_____</td><td style="border-bottom: 1px solid black;">_____</td></tr> </tbody> </table> <p>_____ Live load reduction (1603.2, 1606.7)</p> <p>_____ Roof live loads (1603.3, 1607.0)</p> <p>Roof snow loads (1603.4, 1608.0)</p> <p>_____ Ground snow load, P_g (1608.3)</p> <p>_____ If $P_g > 10$ psf, flat-roof snow load, P_f (1608.4)</p> <p>_____ If $P_g > 10$ psf, snow exposure factor, C_e (Table 1608.4)</p> <p>_____ Sloped roof snowload, P_s (1608.5)</p> <p>_____ If $P_g > 10$ psf, snow load importance factor, I (Table 1609.5)</p> <p>Wind loads (1603.5, 1609.0)</p> <p>_____ Basic wind speed (1609.3)</p> <p>_____ Wind exposure category (1609.4)</p> <p>_____ Wind importance factor, I (Table 1609.5)</p> <p>_____ Wind design pressure, P (1609.7)</p>	Floor Area Use	Loads Shown	_____	_____	_____	_____	_____	_____	_____	_____	_____	_____	<p>Earthquake loads (1603.6, 1610.0)</p> <p>_____ Peak velocity-related acceleration, A_v (1610.1.3)</p> <p>_____ Peak acceleration, A_a (1610.1.3)</p> <p>_____ Seismic hazard exposure group (1610.1.5)</p> <p>_____ Seismic performance category (1610.1.7)</p> <p>_____ Soil-profile type (Table 1610.3.1)</p> <p>_____ Basic structural system and seismic-resisting system (Table 1610.3.3)</p> <p>_____ Response modification factor, R, and deflection amplification factor, C_d (Table 1610.3.3)</p> <p>_____ Analysis procedure (1610.4, 1610.5)</p> <p>Other loads</p> <p>_____ Attic load (1606.2.2, 1606.2.3)</p> <p>_____ Partition loads (1606.2.4)</p> <p>_____ Concentrated loads (1606.3)</p> <p>_____ Impact loads (1606.6)</p> <p>_____ Misc. loads (1606.4, 1606.8, 1606.9, 1607.5, 1612.0)</p> <p>STRUCTURAL DESIGN CALCULATIONS</p> <p>_____ Submitted for all structural members (107.7)</p> <p>_____ Signed/sealed (107.7, 114.1)</p> <p>_____ Deflection limits considered (1604.5)</p>
Floor Area Use	Loads Shown												
_____	_____												
_____	_____												
_____	_____												
_____	_____												
_____	_____												

STRUCTURAL DESIGN CALCULATIONS (continued)

_____	Unbalanced snow loads considered (1608.6)	_____	Internal pressure effects considered (1609.7, 1609.8)
_____	Drift snow loads considered (1608.7)	_____	Components and cladding effects considered (1609.8)
_____	Sliding snow loads considered (1608.8)	_____	Load combinations considered (1613.1)

MATERIAL PERFORMANCE (Chapter 17)

_____	Material performance technical data or BOCA Evaluation Services or National Evaluation Services report supplied (1703.0) Report No. _____	_____	Masonry construction (1705.5)
_____	Owner's special inspection program specified (1705.0)	_____	Wood construction (1705.6)
_____	Prefabricated items (1705.2)	_____	Prepared fill and foundations (1705.7, 1705.8, 1705.9)
_____	Steel construction (1705.3)	_____	Fireresistive materials (1705.12)
_____	Concrete construction (1705.4)	_____	EIFS, wall panels and veneers (1705.10, 1705.13)

FOUNDATIONS AND RETAINING WALLS (Chapter 18)

_____	Soil type (1611.0, 1802.1, 1804.1)	_____	Foundations (1814.0 - 1824.0)
_____	Bearing value (1611.0, 1802.1, 1804.1)	_____	Foundation walls (1611.0, 1812.0)
_____	Soil report (1802.1, 1804.1)	_____	Waterproofing/dampproofing (1813.0)
_____	Prepared fill (1804.1.1)	_____	Retaining walls (1611.0, 1825.0)
_____	Footings (1806.0 - 1811.0)		

STRUCTURAL MATERIALS (Chapters 19, 21, 22, 23)

CONCRETE (Chapter 19)

_____	Plain, reinforced and prestressed concrete design/construction standard specified (1901.1, 1903.1.1)	_____	Minimum concrete strength (Table 1907.1.2[1])
_____	Minimum slab requirements (1905.1)	_____	Cold-weather and hot-weather curing speci- fied (1908.9, 1908.10)

MASONRY (Chapter 21)

_____ ✓	Engineered masonry design/construction standard specified (2101.1.1)	_____ ✓	Cold-weather and hot-weather construction specified (2111.3, 2111.4)
_____ ✓	Empirical masonry design (2101.1.2)	_____ ✓	Fireplaces and chimneys (2103.2, 2113.0 - 2117.0)
_____ ✓	Construction materials (2104.0)	_____ ✓	Glass block (2118.0)
_____ ✓	Mortar type (2104.7)	_____ ✓	

STEEL (Chapter 22)

Structural steel design/construction standard specified (2203.1, 2203.2)	Formed steel design/construction standard specified (2206.1)
Shop drawing preparation specified (2203.4)	Formed steel member identification (2206.6)
Open-web steel joist design/construction standard specified (2205.1)	

WOOD (Chapter 23)

<u>NA</u>	
Installation inspections (2301.2)	Seismic bracing (2305.8)
Design/construction standard specified (2303.1)	Foundation anchorage (2305.17)
Grade mark specified (2303.1.1)	Wood structural panels (2307.0)
HEAVY TIMBER CONSTRUCTION	Particleboard (2308.0)
<u>NA</u>	
Minimum dimensions (605.1, 2304.0)	Fiberboard (2309.0)
Design/construction standard specified (2304.1)	Fireretardant-treated wood (2310.0)
WOOD FRAME CONSTRUCTION	Decay and termite protection (2311.0)
<u>NA</u>	
Fastening and construction details (2305.0, Table 2305.2)	Joist hangers (2312.0)
Wind bracing design required (2305.7)	Prefabricated components (2313.1, 2313.2)
	Metal-plate-connected trusses (2313.3.1, 2313.3.2)

NONSTRUCTURAL MATERIALS (Chapters 24, 25, 26)

GLASS AND GLAZING (Chapter 24)

<u>NA</u>	
Skylights (2404.0)	Safety glazing (2405.0, 2406.0, 2407.0)

GYPSUM BOARD AND PLASTER (Chapter 25)

	<u>NA</u>
Gypsum board materials (2503.0, Table 2503.2, Table 2503.3)	Plaster (2504.0, 2505.0, 2506.0)

PLASTIC (Chapter 26)

<u>NA</u>	
Approved materials (2601.2)	FOAM PLASTIC (2603.0)
Identification (2601.4)	Labeling (2603.2)
Interior trim (2603.7)	Surface-burning characteristics (2603.3)
Alternative approval (2603.8)	Thermal barrier (2603.4)
	Exterior walls (2603.5, 2603.6)

LIGHT-TRANSMITTING PLASTIC (2603.5, 2604.0)

Diffusing systems (2604.5)

Wall panels (2605.0)

N/A

Unprotected openings (2606.0)

Roof panels (2607.0)

Skylight glazing (2608.0)

BUILDING SERVICES (Chapters 28, 30)

MECHANICAL SYSTEMS (Chapter 28)

Waste- and linen-handling systems (2807.0)

Refuse vaults (2808.0)

ELEVATORS AND CONVEYING SYSTEMS (Chapter 30)

Construction standard specified (3001.2)

Elevator emergency operation (3006.2)

Hoistway enclosure (3007.1)

Venting (3007.3 - 3007.6)

Opening protectives (3008.2)

Conveyors and escalators (3010.0, 3011.0)

SPECIAL DEVICES AND CONDITIONS (Chapters 31, 34)

SPECIAL CONSTRUCTION (Chapter 31)

Membrane structures (3103.0)

Flood-resistant construction (3107.0)

Towers (3108.0)

PEDESTRIAN WALKWAYS (3106.0)

Construction and use (3106.1 - 3106.3)

Separation (3106.4)

Local approval (3106.5)

Egress and size (3106.6 - 3106.8)

EXISTING STRUCTURES (Chapter 34) *N/A*

ADDITIONS, ALTERATIONS OR CHANGE OF OCCUPANCY

General requirements (3402.0)

Structural loads (1614.0, 3402.5)

Accessibility (1110.0, 3402.7)

Additions/alterations (3403.0, 3404.0)

Change of occupancy (1110.3, 3405.0)

Compliance alternative evaluation (3408.0)

BUILDING EVALUATION SUMMARY (Table 3408.7)

Existing use group _____	Proposed use group _____
Year building was constructed _____	Number of stories _____ Height in feet _____
Type of construction _____	Area per floor _____
Percentage of open perimeter _____ %	Percentage of height reduction _____ %
Completely suppressed: Yes _____ No _____	Corridor wall rating _____
Compartmentation: Yes _____ No _____	Required door closers: Yes _____ No _____
Fireresistance rating of vertical opening enclosures _____	
Type of HVAC system _____	_____ serving number of floors _____

BUILDING EVALUATION SUMMARY (continued)

Automatic fire detection: Yes _____ No _____, type and location _____
 Fire alarm system: Yes _____ No _____, type _____
 Smoke control: Yes _____ No _____, type _____
 Adequate exit routes: Yes _____ No _____ Dead ends: Yes _____ No _____
 Maximum exit access travel distance _____ Elevator controls: Yes _____ No _____
 Means of egress emergency lighting: Yes _____ No _____ Mixed use groups: Yes _____ No _____

Safety parameters	Fire safety (FS)	Means of egress (ME)	General safety (GS)
3408.6.1 Building height			
3408.6.2 Building area			
3408.6.3 Compartmentation			
3408.6.4 Tenant and dwelling unit separations			
3408.6.5 Corridor walls			
3408.6.6 Vertical openings			
3408.6.7 HVAC systems			
3408.6.8 Automatic fire detection			
3408.6.9 Fire alarm system			
3408.6.10 Smoke control	****		
3408.6.11 Means of egress	****		
3408.6.12 Dead ends	****		
3408.6.13 Max. exit access travel distance	****		
3408.6.14 Elevator control			
3408.6.15 Means of egress emergency lighting	****		
3408.6.16 Mixed use groups		****	
3408.6.17 Sprinklers		+ 2 =	
3408.6.18 Specific occupancy area protection			
Building score — total value			

**** No applicable value to be inserted.

BUILDING SAFETY EVALUATION SCORE (Table 3408.9)

Formula	Table 3408.7	Table 3408.8	Score	Pass	Fail
FS-MFS ≥ 0	_____ (FS)	- _____ (MFS)	= _____	_____	_____
ME-MME ≥ 0	_____ (ME)	- _____ (MME)	= _____	_____	_____
GS-MGS ≥ 0	_____ (GS)	- _____ (MGS)	= _____	_____	_____

FS = Fire Safety
 ME = Means of Egress
 GS = General Safety

MFS = Mandatory Fire Safety
 MME = Mandatory Means of Egress
 MGS = Mandatory General Safety

Applicant: S Live Company

Date: 7/2/01

Address: 135 Marginal Way

C-B-L: 025-B-005

CHECK-LIST AGAINST ZONING ORDINANCE

Date - New

Zone Location - B-5

Interior or corner lot -

Proposed Use/Work - Construct An 88' x 198' shell bldg. for retail office

Sewage Disposal - City

Lot Street Frontage - No min req - 300' shown

Front Yard - None req

Rear Yard - None req

Side Yard - None req

Projections -

Width of Lot - None req

Height - 65' MAX. - 18' scaled

Lot Area - No minimum req - 53,748 # shown per Assessor

Lot Coverage Impervious Surface - 100% Allowed

Area per Family - N/A

Off-street Parking - A-230.5 - None req - 89 spaces shown

Loading Bays - None req

Site Plan - Major # 2000-0142

Shoreland Zoning/Stream Protection - N/A

Flood Plains - Panel 13
Zone C

025-B-005



City of Portland, Maine

389 Congress St., Rm 315
Portland, ME 04101

ACCESSIBILITY CERTIFICATE

TO: Inspector of Buildings City of Portland, Maine
Department of Planning & Urban Development
Division of Housing & Community Services

FROM: CURTIS WALTER STEWART ARCHITECTS

RE: Certificate of Design, HANDICAP ACCESSIBILITY

DATE: 8/30/01

These plans and/or specifications covering construction work on:

- OFFICE BUILDING
- 135 MARCHAL WAY

Have been designed and drawn up by the undersigned, a Maine registered engineer/architect according to State Regulations as adopted by the State of Maine on Handicapped Accessibility.

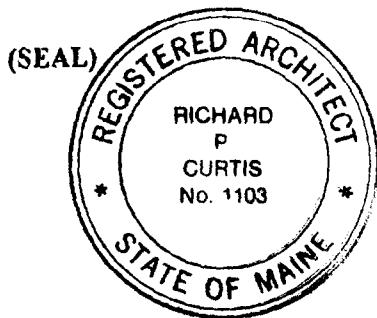

Signature Richard P. Curtis

Title PRESIDENT

Firm CWS ARCHITECTS

Address 434 CUMBERLAND AVENUE
PORTLAND, MAINE 04101

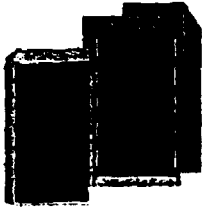

**CITY OF PORTLAND
BUILDING CODE CERTIFICATE**
389 Congress St., Rm 315
Portland, ME 04101

TO: Inspector of Buildings City of Portland, Maine
Department of Planning & Urban Development
Division of Housing & Community Service

FROM: CURTIS WALTER STEWART ARCHITECTS

RE: Certificate of Design

DATE: 8/30/01

These plans and/or specifications covering construction work on:

OFFICE BUILDING - 135 MARGINAL WAY

Have been designed and drawn up by the undersigned, a Maine registered architect/engineer according to the BOCA National Building Code/1999 Fourteenth Edition, and local amendments.

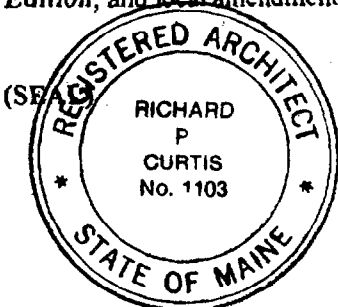

Signature Richard P. Curtis

Title PRESIDENT

Firm CWS ARCHITECTS

Address 434 LUMBERLAND AVE
PORTLAND, MAINE 04101

As per Maine State Law:

\$50,000.00 or more in new construction, repair, expansion, addition, or modification for Building or Structures, shall be prepared by a registered design Professional.

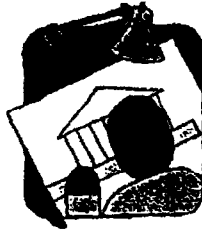

CITY OF PORTLAND MAINE

389 Congress St., Rm 315
Portland, ME 04101
Tel. - 207-874-8704
Fax - 207-874-8716

TO: Inspector of Buildings City of Portland, Maine
Planning & Urban Development
Division of Housing & Community Services

FROM DESIGNER: CURTIS WALTER STEWART ARCHITECTS
434 CUMBERLAND AVE. PORTLAND, ME 04101

DATE: 8/30/01

Job Name: OFFICE BUILDING

Address of Construction: 135 MARSHALL WAY

THE BOCA NATIONAL BUILDING CODE/1999 Fourteenth EDITION
Construction project was designed according to the building code criteria listed below:

Building Code and Year BOCA 1999 Use Group Classification(s) B

Type of Construction 2L Bldg. Height 20'0" Bldg. Sq. Footage 17,940 SF

Seismic Zone _____ Group Class. I/C

Roof Snow Load Per Sq. Ft. 14.2 Dead Load Per Sq. Ft. _____

Basic Wind Speed (mph) 85 Effective Velocity Pressure Per Sq. Ft. 17.0

Floor Live Load Per Sq. Ft. 100 PPF ON FLOOR SLAB

Structure has full sprinkler system? Yes No _____ Alarm System? Yes No _____
Sprinkler & Alarm systems must be installed according to BOCA and NFPA Standards with approval from the Portland Fire Department.

Is structure being considered unlimited area building: Yes _____ No

If mixed use, what subsection of 313 is being considered N/A

List Occupant loading for each room or space, designed into this Project.

UNDETERMINED: BUILDING IS AN EMPTY SHELL AT THIS POINT IN TIME.

(Designers Stamp & Signature)

PSH 6/07/2K

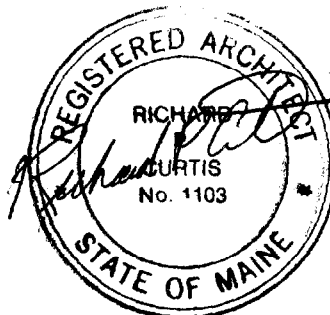

City of Portland INSPECTION SERVICES

Room 315
389 Congress Street
Portland, Maine 04101

Phone: (207) 874-8703 or 874-8693
Fax : (207) 874-8716

FAX TRANSMISSION COVER SHEET

Date: 8/30/01
To: Buse Kiftler
Fax: 772-9078
Re: 3 Doc's Design Pro
Sender: Jeanie Bortke

Forward to
Guy L., CWS
774-4016

YOU SHOULD RECEIVE $\frac{1}{4}$ PAGE(S), INCLUDING THIS COVER SHEET.

IF YOU DO NOT RECEIVE ALL THE PAGES, PLEASE CALL 874-8693 or 874-8703.

RE: 135 N.W.

Guy - FYI - Special Inspections are also req'd - I left message w/ Paul B. to please come up w/ Plan.
BY

Fore River Company

5 Milk Street

P.O. Box 7525

Portland, Maine 04112

(207) 772-6404

TRANSMITTAL NOTICE - BY HAND		DATE: 1/11/00
TO: P. SAMUEL HOFFSES CHIEF OF INSPECTION SERVICES BUILDING INSPECTION CITY OF PORTLAND		SUBJECT: FIVE LIVER COMPANY 135 MARGINAL WAY SITE PLAN REVIEW
NO. OF COPIES: 7 EA (11x17) AND (24x36) 7 " " " 7 " " " 7 " " " 7 " " " 7 EA (11x17) AND (24x36)	DESCRIPTION: DRAWINGS: S-1, SE-1, AND LS-1 DATED 6/30/00 , A1.1 & A 3.1 DATED 5-10-00 WRITTEN STATEMENT DATED 7/1/00 PER §14-525(b)1 RESPONSES DATED 7/1/00 PER §14-525c C.C. LETTER TO CLIFFORD FARRIS, DEPT OF PUBLIC WORKS DRAWING E-LWM DATED 1-10-00	
REMARKS: 2 (24x36) Drawings S-1 (additional site plans) DEAR MR HOFFSES, ATTACHED IS OUR APPLICATION FOR MAJOR SITE PLAN REVIEW FOR A PROPOSED RETAIL/OFFICE BUILDING ON MARGINAL WAY. I BELIEVE THE ONLY OUTSTANDING DRAWING IS AN EMBOSSED SURVEY. I WILL DELIVER THIS DRAWING SHORTLY. PLEASE CALL IF YOU HAVE ANY QUESTIONS, PROBLEMS, OR COMMENTS. SINCERELY, BRUCE KISTLER		

**CITY OF PORTLAND, MAINE
DEVELOPMENT REVIEW APPLICATION
PLANNING DEPARTMENT PROCESSING FORM**

20000142

I. D. Number

Five Liver Company

Applicant

P.O. Box 7525, Portland, ME 04112

Applicant's Mailing Address

Fore River Company

Consultant/Agent

7/12/00

Application Date

Marginal Way

Project Name/Description

135 Marginal Way, Portland Maine 04101

Address of Proposed Site

025-B-001

Assessor's Reference: Chart-Block-Lot

Applicant or Agent Daytime Telephone, Fax

Proposed Development (check all that apply):
 Office Retail Manufacturing Warehouse/Distribution Parking Lot Other (specify)
 New Building Building Addition Change Of Use Residential

18,000 Proposed Building square Feet or # of Units **1.44 ac** Acreage of Site **B5** Zoning

Check Review Required:

- Site Plan (major/minor)
- Flood Hazard
- Zoning Conditional Use (ZBA/PB)
- Subdivision # of lots _____
- Shoreland
- PAD Review
- Historic Preservation
- 14-403 Streets Review
- DEP Local Certification
- Other _____

Fees Paid: Site Plan **\$500.00**

Date: **7/12/00**

Inspections Approval Status

- Approved
- Approval Date _____
- Condition Compliance

Denied

Additional Sheets Attached



Performance Guarantee

* No building permit may be issued until a performance guarantee is submitted.

<input type="checkbox"/> Performance Guarantee Accepted	_____	_____	_____
	date	amount	expiration date
<input type="checkbox"/> Inspection Fee Paid	_____	_____	
	date	amount	
<input type="checkbox"/> Building Permit Issued	_____		
	date		
<input type="checkbox"/> Performance Guarantee Reduced	_____	_____	_____
	date	remaining balance	signature
<input type="checkbox"/> Temporary Certificate of Occupancy	_____	<input type="checkbox"/> Conditions (See Attached)	
	date		
<input type="checkbox"/> Final Inspection	_____	_____	
	date	signature	
<input type="checkbox"/> Certificate Of Occupancy	_____		
	date		
<input type="checkbox"/> Performance Guarantee Released	_____	_____	
	date	signature	
<input type="checkbox"/> Defect Guarantee Submitted	_____	_____	_____
	submitted date	amount	expiration date

Marginal Way - 135

**CITY OF PORTLAND, MAINE
DEVELOPMENT REVIEW APPLICATION
PLANNING DEPARTMENT PROCESSING FORM
DRC Copy**

2000-0142
Application I. D. Number
07/12/2000
Application Date

Five Liver Company
Applicant

PO Box 7525, Portland, ME 04112
Applicant's Mailing Address

Fore River Company
Consultant/Agent

Agent Ph: _____ Agent Fax: _____
Applicant or Agent Daytime Telephone, Fax

Five Liver Company
Project Name/Description

135 - 135 Marginal Way, Portland Maine 04101
Address of Proposed Site

025 B001001
Assessor's Reference: Chart-Block-Lot

Proposed Development (check all that apply): New Building Building Addition Change Of Use Residential Office Retail
 Manufacturing Warehouse/Distribution Parking Lot Other (specify) _____

18,000 1.44 ac B5
Proposed Building square Feet or # of Units Acreage of Site Zoning

Check Review Required:

- | | | | |
|--|---|--|--|
| <input checked="" type="checkbox"/> Site Plan
(major/minor) | <input type="checkbox"/> Subdivision
of lots _____ | <input type="checkbox"/> PAD Review | <input type="checkbox"/> 14-403 Streets Review |
| <input type="checkbox"/> Flood Hazard | <input type="checkbox"/> Shoreland | <input type="checkbox"/> Historic Preservation | <input type="checkbox"/> DEP Local Certification |
| <input type="checkbox"/> Zoning Conditional
Use (ZBA/PB) | <input type="checkbox"/> Zoning Variance | <input type="checkbox"/> Other _____ | |

Fees Paid: Site Plan \$500.00 Subdivision _____ Engineer Review \$1,943.74 Date 08/24/2001

DRC Approval Status:

Reviewer Steve Bushey

- Approved Approved w/Conditions
See Attached Denied

Approval Date 01/09/2001 Approval Expiration 01/09/2002 Extension to _____ Additional Sheets
Attached

Condition Compliance Rick Knowland 01/09/2001
signature date

Performance Guarantee Required* Not Required

* No building permit may be issued until a performance guarantee has been submitted as indicated below

<input type="checkbox"/> Performance Guarantee Accepted	<u>08/22/2001</u> date	<u>\$97,187.00</u> amount	<u>10/29/2003</u> expiration date
<input type="checkbox"/> Inspection Fee Paid	_____ date	_____ amount	
<input type="checkbox"/> Building Permit Issue	_____ date		
<input type="checkbox"/> Performance Guarantee Reduced	_____ date	_____ remaining balance	_____ signature
<input type="checkbox"/> Temporary Certificate of Occupancy	_____ date	<input type="checkbox"/> Conditions (See Attached)	_____ expiration date
<input type="checkbox"/> Final Inspection	_____ date	_____ signature	
<input type="checkbox"/> Certificate Of Occupancy	_____ date		
<input type="checkbox"/> Performance Guarantee Released	_____ date	_____ signature	
<input type="checkbox"/> Defect Guarantee Submitted	_____ submitted date	_____ amount	_____ expiration date
<input type="checkbox"/> Defect Guarantee Released	_____ date	_____ signature	

**CITY OF PORTLAND, MAINE
DEVELOPMENT REVIEW APPLICATION
PLANNING DEPARTMENT PROCESSING FORM
ADDENDUM**

2000-0142

Application I. D. Number

07/12/2000

Application Date

Five Liver Company

Applicant

PO Box 7525, Portland, ME 04112

Applicant's Mailing Address

Fore River Company

Consultant/Agent

Agent Ph:

Agent Fax:

Applicant or Agent Daytime Telephone, Fax

Five Liver Company

Project Name/Description

135 - 135 Marginal Way, Portland Maine 04101

Address of Proposed Site

025 B001001

Assessor's Reference: Chart-Block-Lot

Approval Conditions of Planning

- 1 1.Details for the sanitary sewer service shall be submitted for staff review and approval.
- 2.Final location and spacing of street trees shall be approved by the City Arborist.
- 3.Proposed Hadco and Guth light fixture is acceptable provided that a revised photometric plan of the site shall be submitted for city staff review and approval.

Approval Conditions of Insp

- 1 This permit is being approved on the basis of plans submitted. Any deviations shall require a separate approval before starting that work.
- 2 Separate permits shall be required for each tenant fit up.
- 3 Separate permits shall be required for any new signage.

Approval Conditions of DRC

- 1 See Planning Department's comment.

**DEVELOPMENT REVIEW APPLICATION
PLANNING DEPARTMENT PROCESSING FORM
Planning Copy**

2000-0142
Application I. D. Number

07/12/2000
Application Date

Five Liver Company
Applicant

PO Box 7525, Portland, ME 04112
Applicant's Mailing Address

Fore River Company
Consultant/Agent

Agent Ph: _____ Agent Fax: _____
Applicant or Agent Daytime Telephone, Fax

Five Liver Company
Project Name/Description

135 - 135 Marginal Way, Portland Maine 04101
Address of Proposed Site

025 B001001
Assessor's Reference: Chart-Block-Lot

Proposed Development (check all that apply): New Building Building Addition Change Of Use Residential Office Retail
 Manufacturing Warehouse/Distribution Parking Lot Other (specify) _____

18,000 1.44 ac B5
Proposed Building square Feet or # of Units Acreage of Site Zoning

Check Review Required:

- | | | | |
|--|---|--|--|
| <input checked="" type="checkbox"/> Site Plan
(major/minor) | <input type="checkbox"/> Subdivision
of lots _____ | <input type="checkbox"/> PAD Review | <input type="checkbox"/> 14-403 Streets Review |
| <input type="checkbox"/> Flood Hazard | <input type="checkbox"/> Shoreland | <input type="checkbox"/> Historic Preservation | <input type="checkbox"/> DEP Local Certification |
| <input type="checkbox"/> Zoning Conditional
Use (ZBA/PB) | <input type="checkbox"/> Zoning Variance | <input type="checkbox"/> Other _____ | |

Fees Paid: Site Plan \$500.00 Subdivision _____ Engineer Review \$1,943.74 Date 08/24/2001

Planning Approval Status:

Reviewer rk

- Approved Approved w/Conditions
See Attached Denied

Approval Date 01/09/2001 Approval Expiration 01/09/2002 Extension to _____ Additional Sheets Attached

OK to Issue Building Permit _____
signature date

Performance Guarantee Required* Not Required

* No building permit may be issued until a performance guarantee has been submitted as indicated below

<input type="checkbox"/> Performance Guarantee Accepted	<u>08/22/2001</u> date	<u>\$97,187.00</u> amount	<u>10/29/2003</u> expiration date
<input type="checkbox"/> Inspection Fee Paid	_____ date	_____ amount	
<input type="checkbox"/> Building Permit Issue	_____ date		
<input type="checkbox"/> Performance Guarantee Reduced	_____ date	_____ remaining balance	_____ signature
<input type="checkbox"/> Temporary Certificate of Occupancy	_____ date	<input type="checkbox"/> Conditions (See Attached)	_____ expiration date
<input type="checkbox"/> Final Inspection	_____ date	_____ signature	
<input type="checkbox"/> Certificate Of Occupancy	_____ date		
<input type="checkbox"/> Performance Guarantee Released	_____ date	_____ signature	
<input type="checkbox"/> Defect Guarantee Submitted	_____ submitted date	_____ amount	_____ expiration date
<input type="checkbox"/> Defect Guarantee Released	_____ date	_____ signature	

**CITY OF PORTLAND, MAINE
DEVELOPMENT REVIEW APPLICATION
PLANNING DEPARTMENT PROCESSING FORM
ADDENDUM**

2000-0142

Application I. D. Number

07/12/2000

Application Date

Five Liver Company

Project Name/Description

Five Liver Company

Applicant

PO Box 7525, Portland, ME 04112

Applicant's Mailing Address

Fore River Company

Consultant/Agent

Agent Ph:

Agent Fax:

Applicant or Agent Daytime Telephone, Fax

135 - 135 Marginal Way, Portland Maine 04101

Address of Proposed Site

025 B001001

Assessor's Reference: Chart-Block-Lot

Approval Conditions of Planning

- 1 1.Details for the sanitary sewer service shall be submitted for staff review and approval.
- 2.Final location and spacing of street trees shall be approved by the City Arborist.
- 3.Proposed Hadco and Guth light fixture is acceptable provided that a revised photometric plan of the site shall be submitted for city staff review and approval.

Approval Conditions of Insp

- 1 This permit is being approved on the basis of plans submitted. Any deviations shall require a separate approval before starting that work.
- 2 Separate permits shall be required for each tenant fit up.
- 3 Separate permits shall be required for any new signage.

**CITY OF PORTLAND, MAINE
DEVELOPMENT REVIEW APPLICATION
PLANNING DEPARTMENT PROCESSING FORM
Insp Copy**

2000-0142
Application I. D. Number

07/12/2000
Application Date

Five Liver Compay
Applicant

P.O. Box 7525, Portland, ME 04112
Applicant's Mailing Address

Fore River Company
Consultant/Agent

Five Liver Company
Project Name/Description

135 - 135 Marginal Way, Portland Maine 04101
Address of Proposed Site
025 B001001

Agent Ph: _____ Agent Fax: _____

Applicant or Agent Daytime Telephone, Fax _____

Assessor's Reference: Chart-Block-Lot _____

Proposed Development (check all that apply): New Building Building Addition Change Of Use Residential Office Retail
 Manufacturing Warehouse/Distribution Parking Lot Other (specify) _____

18,000 Proposed Building square Feet or # of Units 1.44 ac Acreage of Site B5 Zoning

Check Review Required:

- | | | | |
|---|--|--|--|
| <input checked="" type="checkbox"/> Site Plan (major/minor) | <input type="checkbox"/> Subdivision # of lots _____ | <input type="checkbox"/> PAD Review | <input type="checkbox"/> 14-403 Streets Review |
| <input type="checkbox"/> Flood Hazard | <input type="checkbox"/> Shoreland | <input type="checkbox"/> Historic Preservation | <input type="checkbox"/> DEP Local Certification |
| <input type="checkbox"/> Zoning Conditional Use (ZBA/PB) | <input type="checkbox"/> Zoning Variance | <input type="checkbox"/> Other _____ | |

Fees Paid: Site Plan \$500.00 Subdivision _____ Engineer Review _____ Date: 07/12/2000

Insp Approval Status:

Reviewer Marge Schmuckal

- Approved Approved w/Conditions See Attached Denied

Approval Date 07/02/2001 Approval Expiration 07/02/2002 Extension to _____ Additional Sheets Attached

Condition Compliance Marge Schmuckal 07/02/2001
signature date

Performance Guarantee Required* Not Required

* No building permit may be issued until a performance guarantee has been submitted as indicated below

<input type="checkbox"/> Performance Guarantee Accepted	_____	_____	_____
	date	amount	expiration date
<input type="checkbox"/> Inspection Fee Paid	_____	_____	
	date	amount	
<input type="checkbox"/> Building Permit Issued	_____		
	date		
<input type="checkbox"/> Performance Guarantee Reduced	_____	_____	_____
	date	remaining balance	signature
<input type="checkbox"/> Temporary Certificate of Occupancy	_____	<input type="checkbox"/> Conditions (See Attached)	_____
	date		expiration date
<input type="checkbox"/> Final Inspection	_____	_____	
	date	signature	
<input type="checkbox"/> Certificate Of Occupancy	_____		
	date		
<input type="checkbox"/> Performance Guarantee Released	_____	_____	
	date	signature	
<input type="checkbox"/> Defect Guarantee Submitted	_____	_____	_____
	submitted date	amount	expiration date

**CITY OF PORTLAND, MAINE
DEVELOPMENT REVIEW APPLICATION
PLANNING DEPARTMENT PROCESSING FORM
ADDENDUM**

2000-0142

Application I. D. Number

07/12/2000

Application Date

Five Liver Company

Project Name/Description

Five Liver Compay

Applicant

P.O. Box 7525, Portland, ME 04112

Applicant's Mailing Address

Fore River Company

Consultant/Agent

Agent Ph:

Agent Fax:

Applicant or Agent Daytime Telephone, Fax

135 - 135 Marginal Way, Portland Maine 04101

Address of Proposed Site

025 B001001

Assessor's Reference: Chart-Block-Lot

Approval Conditions of Insp

- 1 This permit is being approved on the basis of plans submitted. Any deviations shall require a separate approval before starting that work.
- 2 Separate permits shall be required for each tenant fit up.
- 3 Separate permits shall be required for any new signage.

7/7/00

Site Plan Review

New Retail/Office Building Facility at 135 Marginal Way, Portland, Maine

Below are responses to contents requirements as set forth in Portland's Land Use §14-525b. The numbers below correspond to the numbers given in the code.

§14-525(b)1)

- a. **Applicant:** **Five Liver Company**
 P.O. Box 7525
 Portland, ME 04112

- Development Name:** **135 Marginal Way**
 New Retail/Office Building

- b. **See Site Plan.**

- c. **See Site Plan.**

- d. **See Site Plan.**

- e. **See "Grading Plan".**

§14-525(b)2)

- a. **Existing soils – sand, gravel, bricks, ash, grey silty clay, grey silty sand, and gravel.**

- b. **Site is 100% impervious and without rock outcroppings. No easements or rights of way. Drainage on "Grading Plan".**

- c. **See Site Plan, floor plan, and Elevations.**

- d. **See Site Plan.**

- e. **See Site Plan and grading plan (to follow).**

- f. **None.**

- g. **See Site Plan.**

- h. **See Landscape Plan.**

- i. **See Site Plan.**

- j. **See site lighting plan to follow.**

- k. **See Site Plan.**

- l. **N/A.**

- m. **See written statement.**

- n. **See Grading Plan details.**

- o. **All recycling to be by tenants within tenants' spaces.**

7/7/00

Site Plan Review – Written Statements
New Retail/Office Building Facility at 135 Marginal Way, Portland, Maine

Below are responses to written statement requirements as set forth in Portland's Land Use §14-525c. The numbers below correspond to the numbers given in the code.

14-525c: Owners

Five Liver Company (FLC)
P.O. Box 7525
Portland, ME 04112

- 1) Site to be used for retail sales and office uses.
- 2) Land Area
1.44± acres

Proposed Coverage
Bldg, 18,000± SF
- 3) None.
- 4) Normal retail waste.
- 5) Site is currently served by:
PWD – water & sprinklers
Portland Sewer Department – sewer & storm
(a letter to Public Works verifying sewer capacity is attached)
CMP – electrical
Northern Utilities – natural gas
Bell Atlantic – telephone
- 6) Site waste management:

The site currently is mostly impervious with one building. The surrounding land is mostly developed commercial properties. The land immediately to the east is low-lying with various growths that drain to a field inlet east of the site. Storm water on the center of the site drains to an existing catch basin system and is piped into the Marginal Way drainage system. The front portion of the site currently flows overland to Marginal Way.

The plans call for demolition of the existing building and reconstruction of the existing parking areas and storm drain system. The reconstructed storm drain system will include relocation of catch basins to more advantageous locations, new piping, and the installation of a Casco Trap in the catch basin just before the storm water leaves the site.

The plans also call for a new curb cut for shared access to this site and the adjacent site, 161 Marginal Way. A catch basin will be installed to facilitate better drainage around the new curb cut and shared access area and will be piped to the existing catch basin serving the existing curb cut.

The proposed impervious surface area is consistent with the existing surface and therefore should impose no increased runoff. It is not anticipated that this project will have an increased adverse effect on the downstream receiving area. A letter from Public Works verifying capacity has been requested. An erosion control plan is part of this project with details and instructions on the plans.

- 7) **Permitting – 1 month**
Construction – 6 months
 - **Demolition**
 - **Site work**
 - **New building construction**
- 8) **None.**
- 9) **To follow.**
- 10) **See attached tax bills.**
- 11) **None.**
- 12) **Any plans in this format will follow.**
- 13) **Recycling will be the responsibility of the individual tenants. Storage of recyclables will be within tenants' spaces.**

City of Portland

July 1, 1999 - June 30, 2000

DUE SEPT. 10, 1999	DUE MARCH 10, 2000	AMOUNT PAID	INTEREST DUE	PAY THIS AMOUNT
\$99.01	\$99.01	\$99.01	\$0.00	\$99.01

SECOND BILLING
F15489

LENDING INST: Assessed Property Description

ACCOUNT NUMBER 000003446 F15489 025 - B-022-001

 25-B-22
MARGINAL WAY 147
5/12 INTEREST
7116 SF

BRING COMPLETE TAX BILL WHEN PAYING IN PERSON.

Please Make Your Check Payable to:
City of Portland

PARTIAL PAYMENTS MAY BE MADE AT ANY TIME.

 FIVE LIVER COMPANY
5 MILK ST
PORTLAND, ME 04101

Change of Address

Name:

RETURN THIS TOP PORTION WITH PAYMENT

Credit cards are not accepted for property tax payments.

KEEP THIS PORTION

2000 REAL ESTATE PROPERTY TAX STATEMENT
City of Portland

Fiscal Year 2000
July 1, 1999 - June 30, 2000

Owner of Record as of April 1, 1999



ACCOUNT NUMBER
000003446 F15489
CBL
025 - B-022-001
LENDING INST.

Assessed Property Description
25-B-22
MARGINAL WAY 147
5/12 INTEREST
7116 SF

FIVE LIVER COMPANY
5 MILK ST
PORTLAND, ME 04101

CURRENT BILLING DISTRIBUTION

School	\$105.15
Public Works	\$12.48
Parks & Recreation	\$5.94
Fire	\$14.65
Police	\$16.04
Debt Repayments	\$21.10
General Government	\$8.91
County	\$5.74
Health & Human Services	(\$5.15)
Library	\$6.73
Metro Transit District	\$4.55
Enterprise Funds	(\$1.19)
Regional Waste Systems	\$2.97

CURRENT BILLING INFORMATION

Land Value	\$7,830.00
Building Value	\$0.00
Total Value	\$7,830.00
Exemptions	\$0.00
Homestead	\$0.00
Taxable Value	\$7,830.00
Tax Rate	\$25.29
TOTAL TAX	\$198.02
AMOUNT PAID	\$99.01

Remittance Instructions

To avoid standing in line, it is recommended that taxes be paid by mail. Please make check or money order payable to: **CITY OF PORTLAND**. Credit cards are not accepted for property tax payments.

Use enclosed envelope to mail in your payment.

Please be sure remittance address on back side of RETURN portion of this tax bill is clearly visible through the window in the return envelope.

Use top right margin for change of address and check off box on return envelope.

A Greater Portion of this Lot

City of Portland

July 1, 1999 - June 30, 2000

DUE SEPT. 10, 1999	DUE MARCH 10, 2000	AMOUNT PAID	INTEREST DUE	PAY THIS AMOUNT
\$3,433.50	\$3,433.50	\$3,433.50	\$0.00	\$3,433.50

SECOND BIL
F15488

LENDING INST: Assessed Property Description

ACCOUNT NUMBER 000003438 F15488 025 - B-005-001

 25-B-5
MARGINAL WAY 131-145
46632 SQ FT

BRING COMPLETE TAX BILL WHEN PAYING IN PERSON.

Please Make Your Check Payable to:
City of Portland

PARTIAL PAYMENTS MAY BE MADE AT ANY TIME.

 FIVE LIVER COMPANY
5 MILK ST
PORTLAND, ME 04101

Change of Address

Name:

RETURN THIS TOP PORTION WITH PAYMENT

Credit cards are not accepted for property tax payments.

KEEP THIS PORTION

2000 REAL ESTATE PROPERTY TAX STATEMENT
City of Portland

Fiscal Year 2000
July 1, 1999 - June 30, 2000

Owner of Record as of April 1, 1999



ACCOUNT NUMBER
000003438 F15488
CBL
025 - B-005-001
LENDING INST.

Assessed Property Description
25-B-5
MARGINAL WAY 131-145
46632 SQ FT

FIVE LIVER COMPANY
5 MILK ST
PORTLAND, ME 04101

CURRENT BILLING DISTRIBUTION

School	\$3,646.38
Public Works	\$432.62
Parks & Recreation	\$206.01
Fire	\$508.16
Police	\$556.23
Debt Repayments	\$734.77
General Government	\$309.02
County	\$199.14
Health & Human Services	(\$178.54)
Library	\$233.46
Metro Transit District	\$157.94
Enterprise Funds	(\$41.20)
Regional Waste Systems	\$103.01

CURRENT BILLING INFORMATION

Land Value	\$132,840.00
Building Value	\$138,690.00
Total Value	\$271,530.00
Exemptions	\$0.00
Homestead	\$0.00
Taxable Value	\$271,530.00
Tax Rate	\$25.29
TOTAL TAX	\$6,867.00
AMOUNT PAID	\$3,433.50

Remittance Instructions

To avoid standing in line, it is recommended that taxes be paid by mail. Please make check or money order payable to: **CITY OF PORTLAND**. Credit cards are not accepted for property tax payments.

Use enclosed envelope to mail in your payment.

Please be sure remittance address on back side of RETURN portion of this tax bill is clearly visible through the window in the return envelope.

Use top right margin for change of address and check off box on return envelope.

A Portion of this Lot

City of Portland

July 1, 1999 - June 30, 2000

DUE SEPT. 10, 1999 \$6,584.76	DUE MARCH 10, 2000 \$6,584.76	AMOUNT PAID \$6,584.76	INTEREST DUE \$0.00	PAY THIS AMOUNT \$6,584.76
----------------------------------	----------------------------------	---------------------------	------------------------	-------------------------------

SECOND BILLING
S38420

LENDING INST: Assessed Property Description
 ACCOUNT NUMBER 000003430 S38420 025 - B-001-001 25-B-1
 MARGINAL WAY 149-171
 52355 SQ FT



SOUTHERN MAINE PROPERTIES
 COMPANY
 5 MILK ST P O BOX 7525
 PORTLAND, ME 04112

BRING COMPLETE TAX BILL WHEN
 PAYING IN PERSON.

Please Make Your Check Payable to:
 City of Portland

PARTIAL PAYMENTS MAY BE MADE
 AT ANY TIME.

RETURN THIS TOP PORTION WITH PAYMENT

Credit cards are not accepted for property tax payments.

KEEP THIS PORTION

2000 REAL ESTATE PROPERTY TAX STATEMENT
 City of Portland

Fiscal Year 2000
 July 1, 1999 - June 30, 2000

Owner of Record as of April 1, 1999



SOUTHERN MAINE PROPERTIES
 COMPANY
 BOX 7525 DTS, 5 MILK ST
 PORTLAND, ME 04112

Assessed Property Description
 25-B-1
 MARGINAL WAY 149-171
 52355 SQ FT

ACCOUNT NUMBER
 000003430 S38420
 CBL
 025 - B-001-001
 LENDING INST.

CURRENT BILLING DISTRIBUTION

School	\$6,993.02
Public Works	\$829.68
Parks & Recreation	\$395.09
Fire	\$974.54
Police	\$1,066.73
Debt Repayments	\$1,409.14
General Government	\$592.63
County	\$381.92
Health & Human Services	(\$342.41)
Library	\$447.76
Metro Transit District	\$302.90
Enterprise Funds	(\$79.02)
Regional Waste Systems	\$197.54

CURRENT BILLING INFORMATION

Land Value	\$146,520.00
Building Value	\$374,220.00
Total Value	\$520,740.00
Exemptions	\$0.00
Homestead	\$0.00
Taxable Value	\$520,740.00
Tax Rate	\$25.29
TOTAL TAX	\$13,169.52
AMOUNT PAID	\$6,584.76

Remittance Instructions

To avoid standing in line, it is recommended that taxes be paid by mail. Please make check or money order payable to: **CITY OF PORTLAND**. Credit cards are not accepted for property tax payments.

Use enclosed envelope to mail in your payment.

Please be sure remittance address on back side of RETURN portion of this tax bill is clearly visible through the window in the return envelope.

Use top right margin for change of address and check off box on return envelope.

A PORTION OF THIS LOT

City of Portland

July 1, 1999 - June 30, 2000

DUE SEPT. 10, 1999 \$160.47	DUE MARCH 10, 2000 \$160.47	AMOUNT PAID \$160.47	INTEREST DUE \$0.00	PAY THIS AMOUNT \$160.47
--------------------------------	--------------------------------	-------------------------	------------------------	-----------------------------

SECOND BILLING
S38425

LENDING INST: Assessed Property Description
 ACCOUNT NUMBER 000003440 S38425 025 - B-006-001 25-B-6
 R MARGINAL WAY 137
 2676SF



SOUTHERN MAINE PROPERTIES
 COMPANY
 5 MILK ST P O BOX 7525
 PORTLAND, ME 04112

BRING COMPLETE TAX BILL WHEN
 PAYING IN PERSON.

Please Make Your Check Payable to:
 City of Portland

PARTIAL PAYMENTS MAY BE MADE
 AT ANY TIME.

RETURN THIS TOP PORTION WITH PAYMENT

Credit cards are not accepted for property tax payments.

KEEP THIS PORTION

2000 REAL ESTATE PROPERTY TAX STATEMENT
 City of Portland

Fiscal Year 2000
 July 1, 1999 - June 30, 2000

Owner of Record as of April 1, 1999



SOUTHERN MAINE PROPERTIES
 COMPANY
 BOX 7525 DTS, 5 MILK ST
 PORTLAND, ME 04101

Assessed Property Description
 25-B-6
 R MARGINAL WAY 137
 2676SF

ACCOUNT NUMBER
 000003440 S38425
 CBL
 025 - B-006-001
 LENDING INST.

CURRENT BILLING DISTRIBUTION

School	\$170.42
Public Works	\$20.22
Parks & Recreation	\$9.63
Fire	\$23.75
Police	\$26.00
Debt Repayments	\$34.34
General Government	\$14.44
County	\$9.31
Health & Human Services	(\$8.34)
Library	\$10.91
Metro Transit District	\$7.38
Enterprise Funds	(\$1.99)
Regional Waste Systems	\$4.81

CURRENT BILLING INFORMATION

Land Value	\$8,820.00
Building Value	\$3,870.00
Total Value	\$12,690.00
Exemptions	\$0.00
Homestead	\$0.00
Taxable Value	\$12,690.00
Tax Rate	\$25.29
TOTAL TAX	\$320.94
AMOUNT PAID	\$160.47

Remittance Instructions

To avoid standing in line, it is recommended that taxes be paid by mail. Please make check or money order payable to: **CITY OF PORTLAND**. Credit cards are not accepted for property tax payments.

Use enclosed envelope to mail in your payment.

Please be sure remittance address on back side of RETURN portion of this tax bill is clearly visible through the window in the return envelope.

Use top right margin for change of address and check off box on return envelope.

A PORTION OF THIS LOT

Fore River Company

5 Milk Street

P.O. Box 7525

Portland, ME 04112

(207) 772-6404

July 7, 2000

Clifford Farris, Sewage Facility Tech.
Department of Public Works
City of Portland
55 Portland Street
Portland, ME 04101

re: 135 Marginal Way Storm and Sanitary Sewer Capacity

Dear Mr. Farris,

We are applying for Site Plan Review from the City of Portland for our site at 135 Marginal Way. One of the requirements for Site Plan approval is a letter from Public Works verifying storm and sanitary sewer capacity. Public Works told me you are responsible for these letters.

Briefly, our plans call for the demolition of the existing building, currently Mail Boxes Etc, and the construction of a new 90' x 180' building, reconstruction of the parking lot and storm sewer system, and a new sanitary sewer connection.

The plans for the site call for reconstruction of the existing storm water system by relocating catch basins to more advantageous locations, new piping and the addition of a Casco Trap to the last catch basin just before the storm water is piped off the site.

Because the proposed impervious surface plan is consistent with the existing surface it is not anticipated that this project will have any increased effect on the Marginal Way drainage for the downstream receiving area.

The sanitary sewer plans call for capping the existing 4" C1 service to the existing building and installation of a new 6" line to service the new building. The building is proposed to be for typical retail/office users.

Please review the attached plans and call me with any questions or problems.

Sincerely,

Bruce Kistler

enclosure

Fore River Company

5 Milk Street

P.O. Box 7525 Portland, Maine 04112 (207) 772-6404

TRANSMITTAL NOTICE - By Hand		DATE: 7/12/00
TO: P. SAMUEL HOFFSEY CHIEF OF INSPECTION SERVICES BUILDING INSPECTION CITY OF PORTLAND		SUBJECT: FIVE LEVEL COMPANY 135 MARGINAL WAY MAJOR SITE PLAN REVIEW
NO. OF COPIES: 9 (24x36) 9 (11x17) 7	DESCRIPTION: SITE PLAN w/ SURVEYOR STAMP 7/12/00 COPY OF ABOVE SITE LIGHTING FIXTURE DATA CUTS	
REMARKS: <p>DEAR MR. HOFFSEY,</p> <p>I believe the ATTACHED ALONG WITH OUR SUBMITTAL YESTERDAY completes the APPLICATION for Major Site Plan Review AS CALLED FOR UNDER the ZONING Code. I would appreciate it IF you would REVIEW this application AND give me a formal OR informal confirmation that this application is or is NOT complete. Also do you know when this project will be scheduled for Planning Board Review.</p> <p>Sincerely,</p> <p>BRUCE KISTLER</p>		

TYPE: A

CATALOG #: GMX40129AR

McGRAW-EDISON®

DESCRIPTION

McGraw-Edison's Galleria combines beauty and versatility to make it an excellent choice for architects, specifiers and contractors in today's energy- and design-conscious environment. An aesthetic reveal in the formed aluminum housing gives the Galleria a distinctive look while a variety of mounting options and lamp wattages provide maximum flexibility.

APPLICATION

The Galleria achieves superior light distribution by utilizing a seamless reflector system, making it the optimum choice for almost any small or medium area lighting application.

SPECIFICATION FEATURES

A...Housing

Formed aluminum housing with stamped reveal has interior-welded seams for structural integrity and is finished in polyester powder coat. U.L. listed for wet locations. CSA approved.

B...Ballast Tray

Ballast tray is hard-mounted to housing interior for cooler operation.

C...Ballast

Long-life core and coil ballast.

D...Reflector

Spun and stamped aluminum reflector in vertical lamp units, or hydroformed anodized aluminum reflector in horizontal lamp units.

E...Door

Formed aluminum door has heavy-duty hinges, captive retaining screws and is finished in polyester powder coat. (Spider mount unit has steel door.)

F...Lens

Convex tempered glass lens.

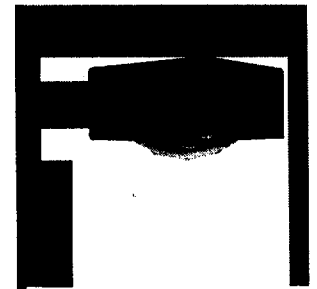
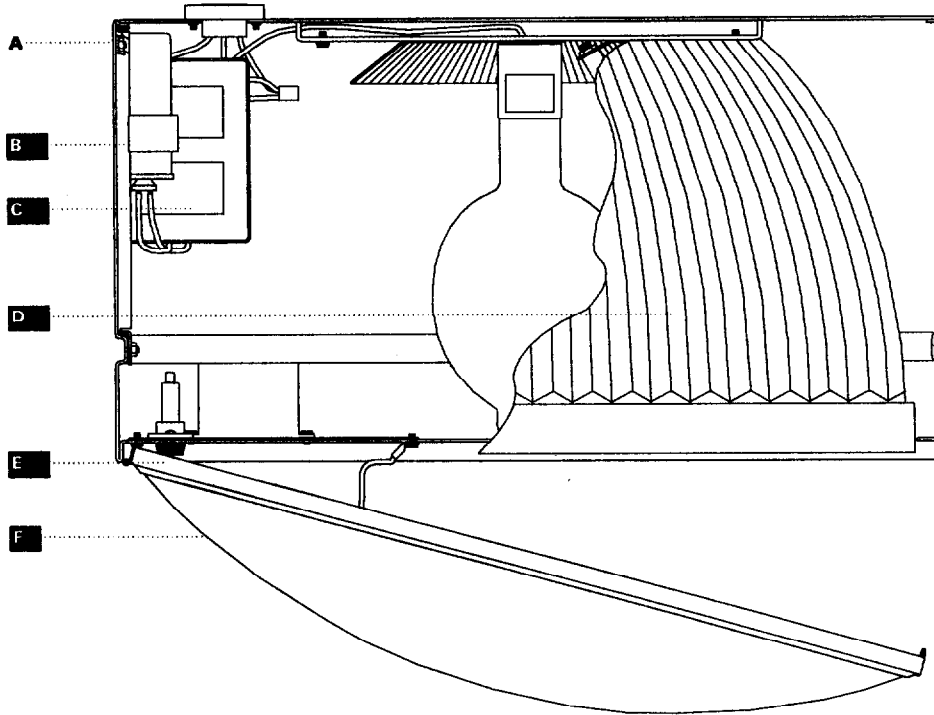

GMGALLERIA
250-400W

Metal Halide

ARCHITECTURAL
AREA LIGHT

*Mounted on
20' poles*

DIMENSIONS

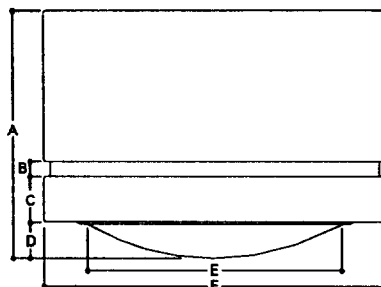

Fixture	A	B	C	D	E	F	G	H	J
Medium (in.)	15	3/4	3	4	18 3/4	21 3/4	6 or 14	12	21
(mm)	381	19	76	102	476	552	152 or 356	305	533

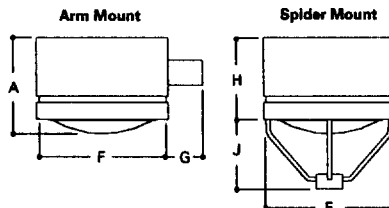

ENERGY DATA

CWA Ballast Input Watts
250W MH HPF (295 Watts)
400W MH HPF (485 Watts)

PHOTOMETRICS

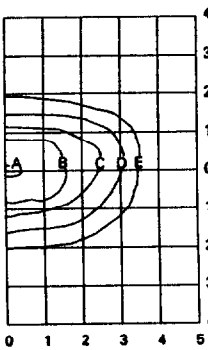

GM-5
GMA401291D
400-Watt MH Type I
40,000-Lumen Clear Lamp

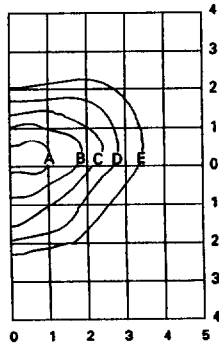

GM-6
GMA401292D
400-Watt MH Type II
40,000-Lumen Clear Lamp

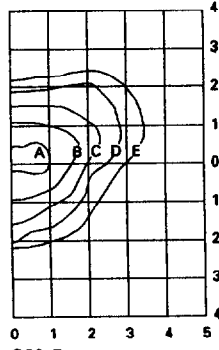

GM-7
GMA401293D
400-Watt MH Type III
40,000-Lumen Clear Lamp

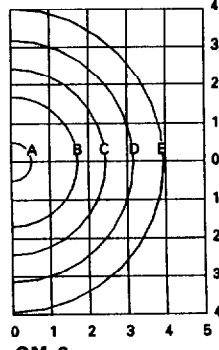

GM-8
GMA40129AR
400-Watt MH Area Round
40,000-Lumen Clear Lamp

Footcandle Table

Select mounting height and read across for footcandle values of each isofootcandle line.

Mounting Height	Footcandle Values for Isofootcandle Lines				
	A	B	C	D	E
20'	11.25	4.50	2.25	1.12	0.56
25'	7.20	2.88	1.44	0.72	0.36
30'	5.00	2.00	1.00	0.50	0.25
35'	3.57	1.43	0.71	0.36	0.18
40'	2.50	1.00	0.50	0.25	0.13

Footcandle Table

Select mounting height and read across for footcandle values of each isofootcandle line.

Mounting Height	Footcandle Values for Isofootcandle Lines				
	A	B	C	D	E
20'	4.50	2.25	1.13	0.56	0.23
25'	2.83	1.14	0.72	0.36	0.14
30'	2.00	1.00	0.50	0.25	0.10
35'	1.47	0.73	0.37	0.18	0.07
40'	1.12	0.56	0.28	0.14	0.06

MOUNTING VARIATIONS

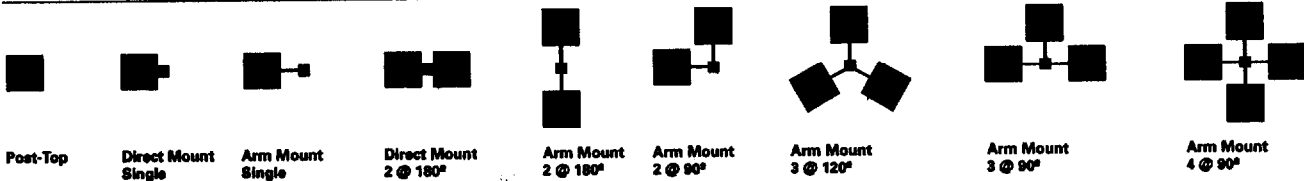

ORDERING INFORMATION

SAMPLE NUMBER: GMA251292D

G M A 40 1 2 9 FT

Product Family
G-Galleria

Housing Size
M-Medium

Mounting Method
A-Arm
B-Spider
C-Spider for 3 1/2" O.D. tenon

Lamp Wattage
25-250
40-400

Lamp Type
1-MH

Ballast Type
2-CWA

Voltage
1-120V
2-208V
3-240V
4-277V
5-480V
6-Triple-Tap wired 347V

Distribution
1D-Type I MCO
2D-Type II MCO
3D-Type III MCO
FT-Forward Throw
AR-Area Round
AS-Area Square
RW-Rectangular Wide

Options (add as suffix)
F-Single Fuse
FF-Double Fused
R-Photocontrol Receptacle
Q-Quartz Restrike
HS-House Side Shield (AR and AS distributions only)
VS-Vandal Shield

Accessories (order separately)
MA1004-14" arm for square pole. 1.0 EPA
MA1005-6" arm for square pole. 0.5 EPA
MA1006-Direct mount kit for square pole
MA1007-14" arm for round pole. 1.0 EPA
MA1008-6" arm for round pole. 0.5 EPA
MA1009-Direct mount kit for round pole
OA1016-Photocontrol-Multi-Tap
OA1027-Photocontrol-480V
MA1010-Single-arm tenon adapter for 3" tenon
MA1011-2 @ 90° tenon adapter for 3" tenon
MA1012-3 @ 120° tenon adapter for 3" tenon
MA1013-4 @ 90° tenon adapter for 3" tenon
MA1014-2 @ 90° tenon adapter for 3" tenon
MA1015-2 @ 120° tenon adapter for 3" tenon
MA1016-3 @ 90° tenon adapter for 3" tenon
MA1017-Single-arm tenon adapter for 2" tenon
MA1018-2 @ 180° tenon adapter for 2" tenon
MA1028-Wall bracket

Catalog Number*	Lamp Wattage	Lamp Type*	Ballast Type/ Power Factor	Voltage ¹	Size	Net Wt. (Lbs.)	Shipping Volume (Cu.Ft.)
Arm Mount (Order arm separately)							
GMA25129XX	250	MH	CWA/HPF	MT	Medium	64	5.5
GMA40129XX	400	MH	CWA/HPF	MT	Medium	64	5.5
Spider Mount (For 2 3/8" O.D. tenon)							
GMB25129XX	250	MH	CWA/HPF	MT	Medium	57	9.1
GMB40129XX	400	MH	CWA/HPF	MT	Medium	57	9.1
Spider Mount (For 3 1/2" O.D. tenon)							
GMC25129XX	250	MH	CWA/HPF	MT	Medium	59	9.1
GMC40129XX	400	MH	CWA/HPF	MT	Medium	59	9.1

NOTES: ¹ Arm not included. See accessories.
² Designate distribution by changing 9th and 10th digits.
³ All lamps are mogul base. Lamps are not included.
⁴ Multi-Tap ballast is 120/208/240/277V. Triple-Tap ballast is 120/277/347V.

Colors (add as suffix)
AP=Gray
—=Bronze (standard)
BG=Beige
BK=Black
BL=Blue
GR=Green
RD=Red
SY=Silver
WH=White
YL=Yellow

NOTE: Specifications and Dimensions subject to change without notice.



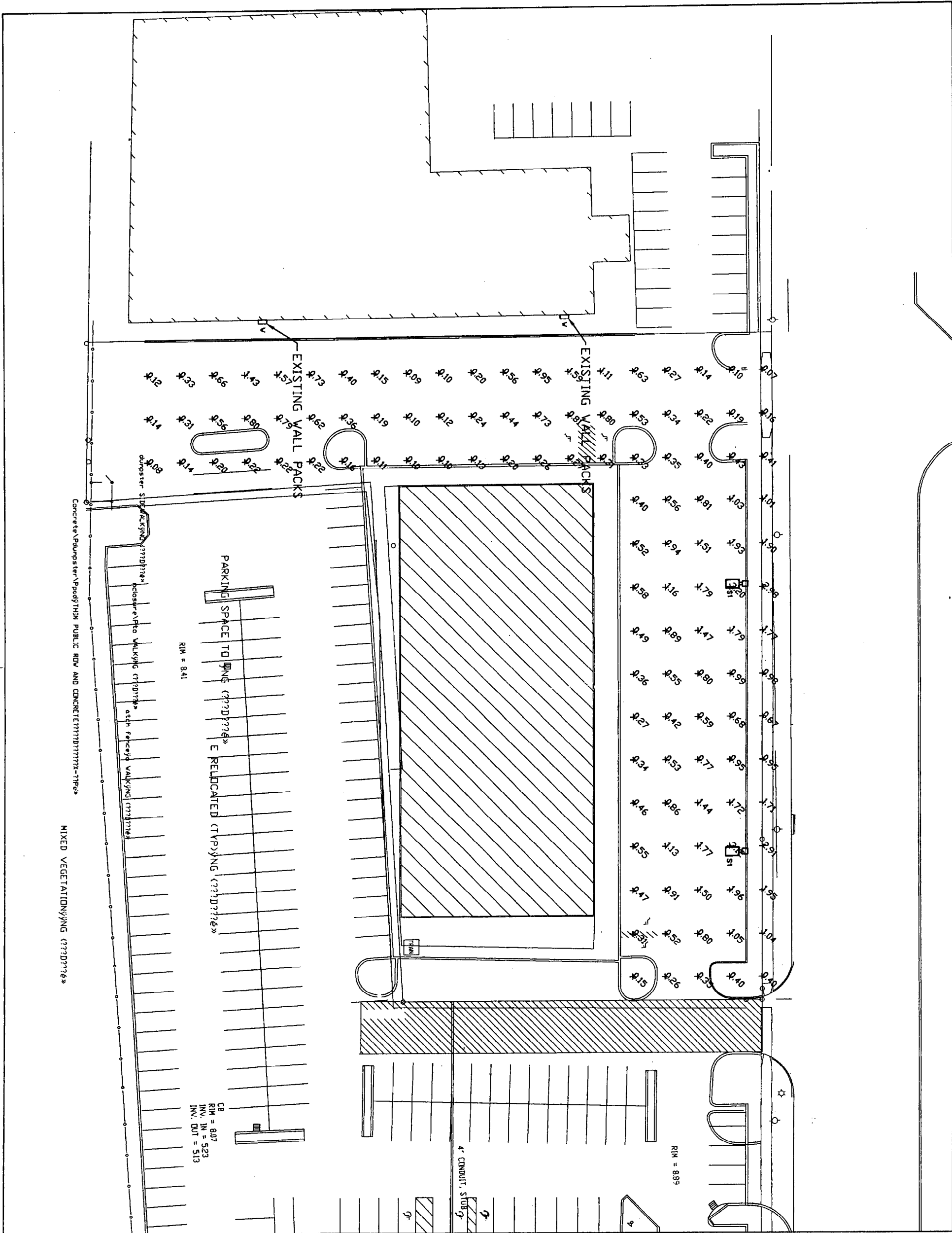

STAMP

BH MILLIKEN
 LIGHTING CONSULTANTS
 177 ANDERSON STREET
 PORTLAND, MAINE 04101
 PHONE: 734-1111
 FAX: 734-1112

FORE RIVER
Five Liver Company
 135 MARGINAL WAY
 PORTLAND, MAINE

TITLE
 SITE LIGHTING CALC.

SCALE: 1"=20'
 DATE: 7-10-00

SHEET

E-LUM

434 Cumberland Avenue
 Portland, ME 04101
 Phone: (207)774-4441
 Fax: (207)774-4016
 PO Box 6255
 Liscata, NH 03217
 Phone: (603)24-3000
 Fax: (603)627-0700
www.CWSarch.com

**FORE RIVER
 COMPANY**
 5 Mt. Street
 Portland, ME 04101
 (207) 772-6404

General Contractor:

**OFFICE
 BUILDING**
 65 Marginal Way
 Portland, ME

Tenants: *****

Project No: 2000A11
 Drawing Title:

**FLOOR
 PLAN**

Scale: 1/8"=1'-0"
 Date: Prog. 5/10/00
 Revision Dates:

Drawing Number:

A1.1

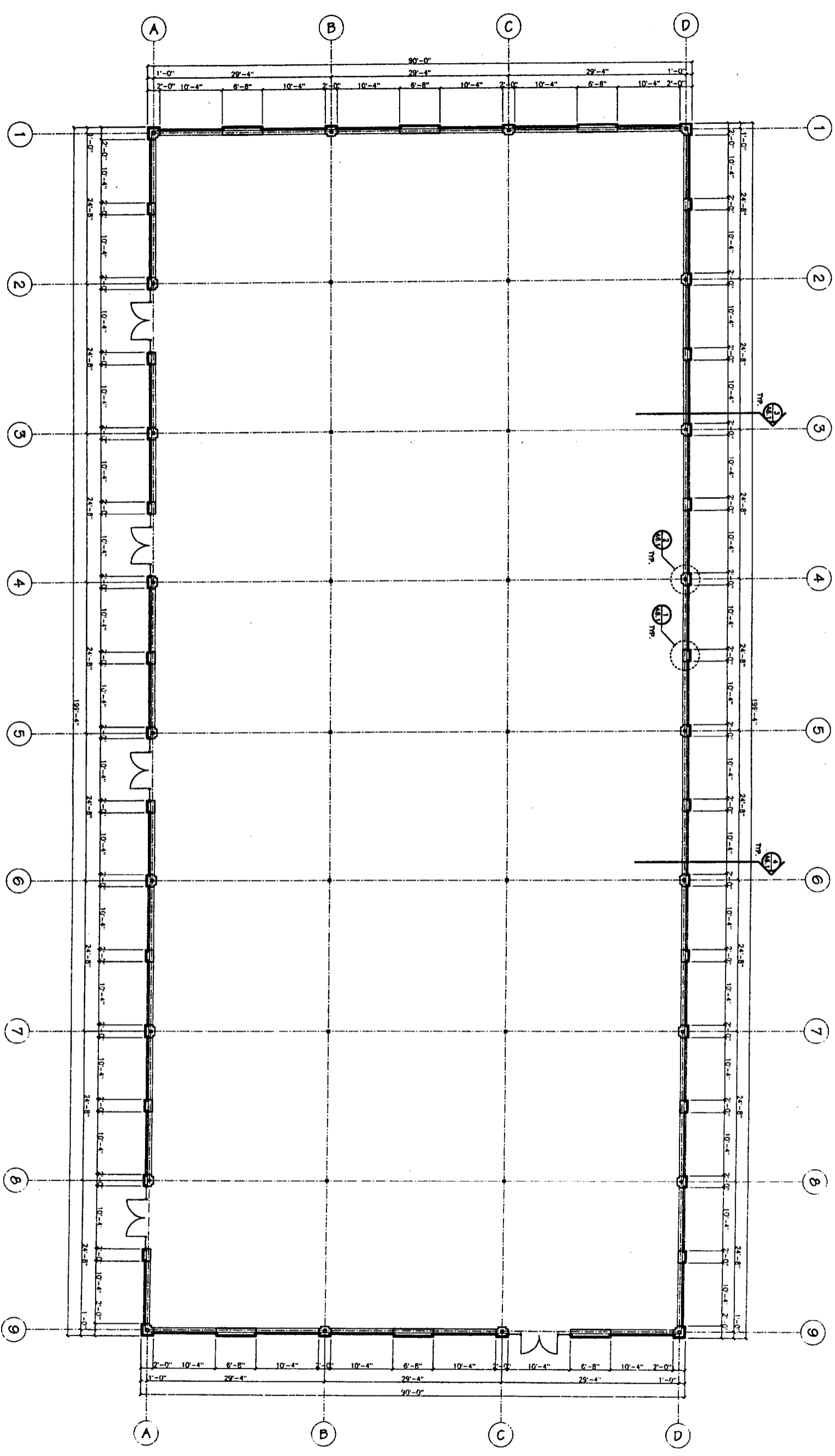

A
FLOOR PLAN
REFERENCE

CONCEPTUAL PLAN

SCALE: 1/8" = 1'-0"

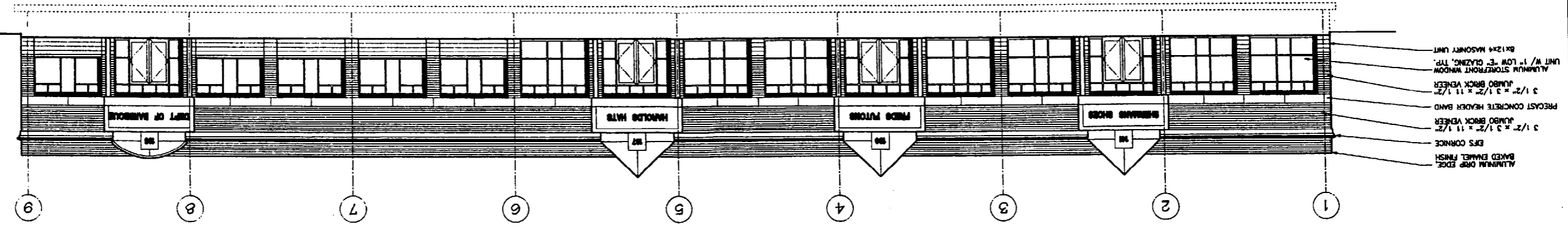

1 FRONT ELEVATION
SCALE: 1/8" = 1'-0"
REFERENCE:

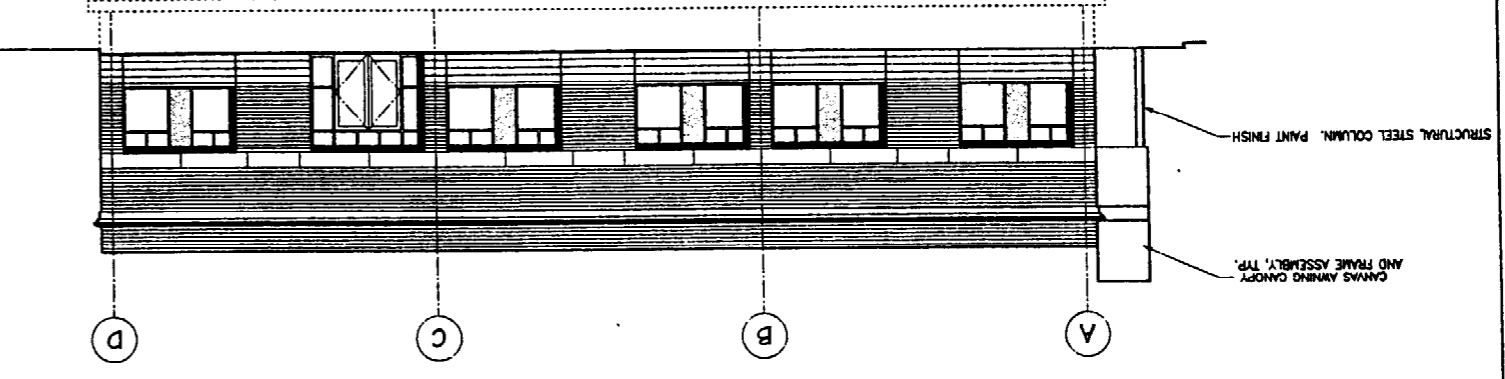

2 RIGHT ELEVATION
SCALE: 1/8" = 1'-0"
REFERENCE:

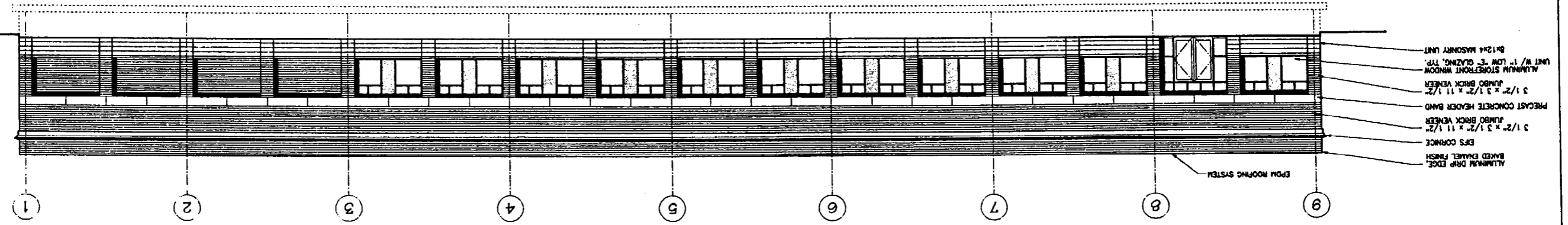

3 BACK ELEVATION
SCALE: 1/8" = 1'-0"
REFERENCE:

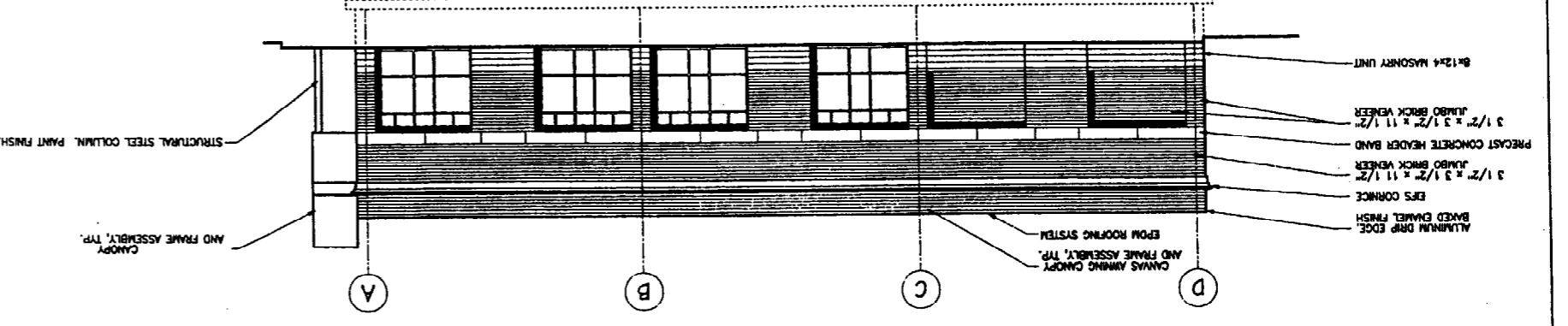

4 LEFT ELEVATION
SCALE: 1/8" = 1'-0"
REFERENCE:

CONCEPTUAL PLAN

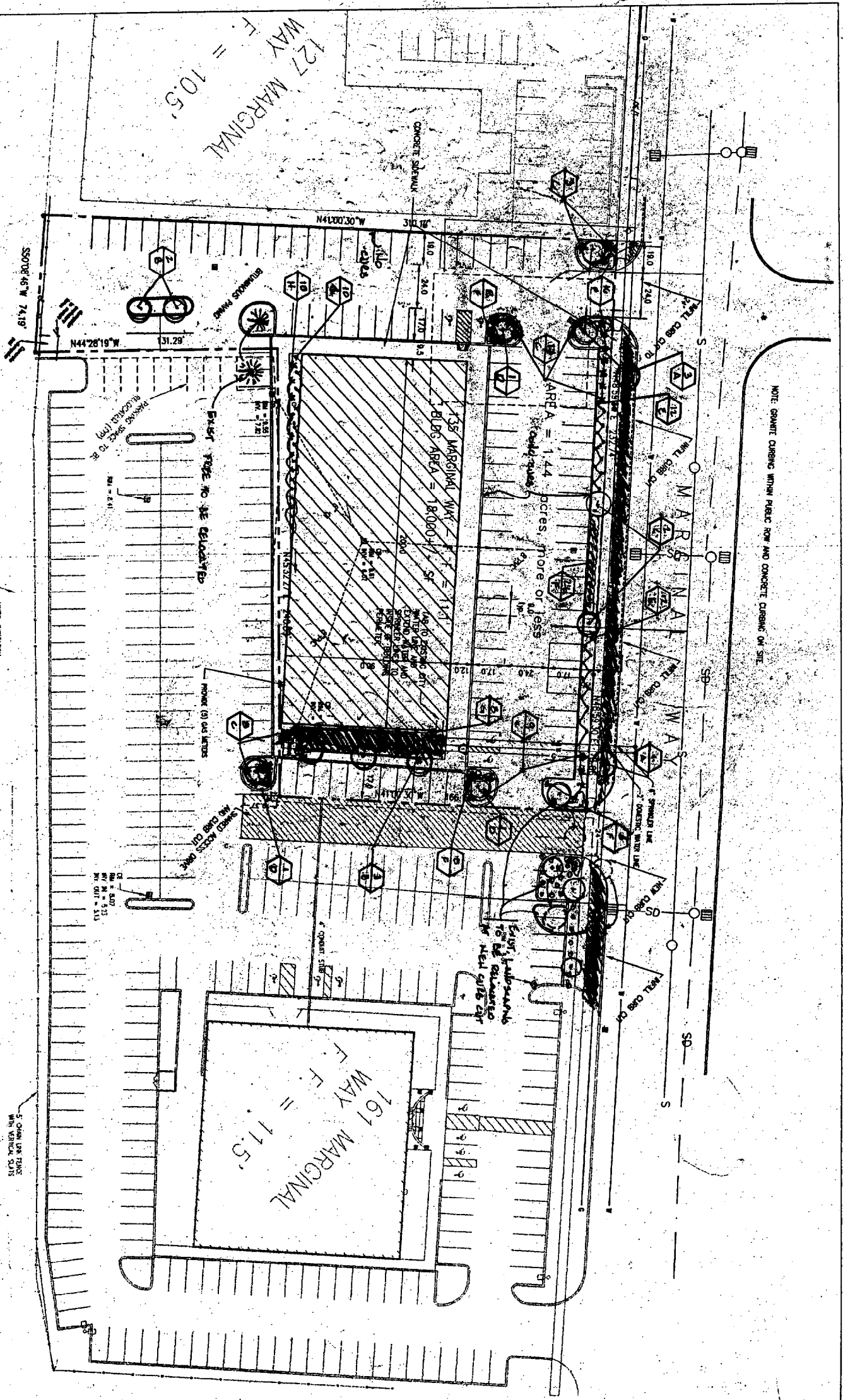
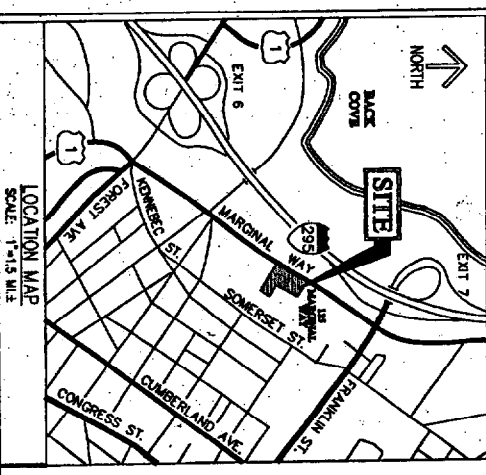

NOTE: GRANT CARBING WITHIN PUBLIC ROW AND CONCRETE CARBING ON SITE.

Site Plan Notes:
 Landscaping shall meet the "Municipal Specifications and Standards of Practice and Landscaping Guidelines" of the City of Portland, Oregon, and Oregon Standards and Guidelines.
 The entire site shall be developed and/or maintained as depicted on the site plan. Approval of the Planning Authority or Planning Board shall be required for any deviation or deviation from the approved site plan, including, without limitation, changes in site plan, location, height, location and use of buildings.
 All perimeter utilities shall be underground.
 Sidewalks and curbing shall be designed and built with to down slopes at all street corners, crosswalks and driveways in conformance with the City of Portland Technical and Design Standards and Guidelines.
 All existing and proposed control measures shall be designed in accordance with the Urban Erosion and Sediment Control Handbook for Construction, Building Department, Portland, Oregon, published by the Building Department, March 1991 or latest edition. [Note: The site plan should specify the erosion control device to be employed (silt fence, hay bales, etc.) as well as the location.]
 All erosion control measures shall be installed prior to any site excavation or regrading.
 All disturbed areas on the site not covered by building or paved areas shall be stabilized with top soil and seed or other methods as required by the Building Department and Practices (see above).
 Prior to construction a preconstruction meeting shall be held at the project site with the contractor, development review coordinator, Public Works representative and owner to review the construction schedule and critical aspects of the site work. At that time, the site plan, the site plan representative and provide three (3) copies of a detailed construction schedule to the planning City representative. It shall be the contractor's responsibility to arrange a mutually agreeable time for the preconstruction meeting.
REFER TO SITE PLAN FOR ADDITIONAL INFORMATION.

PLANT LIST

Plant	Quantity	Notes
A	4	Large Redwood Tree
B	5	Redwood Hedge
C	35	Scrub Shrub
D	3	Koeleria
E	34	Small Shrub
F	44	Small Shrub
G	12	Small Shrub
H	12	Small Shrub
I	12	Small Shrub
J	12	Small Shrub
K	4	Small Shrub

LEGEND

- PROPERTY LINE
- EASEMENT
- ADJACENT BACKGROUND UTILITY
- BUILDING
- CATCH BASIN
- CONCRETE CURB
- CONCRETE CURB
- CONCRETE CURB
- DRIVEWAY
- EDGE OF CONCRETE SURFACE
- EDGE OF DRIVEWAY PAVED SURFACE
- FENCE
- GAS MAIN
- GAS VALVE
- PERMANENT
- ROCK AND GRAVEL
- ROCK PERI-PER
- LIGHT POLE
- OVERHEAD ELECTRIC & TELEPHONE
- NUMBER OF PARKING SPACES IN ROW
- STREET LIGHT
- SEWER MAIN
- UNDERGROUND ELECTRIC
- UNDERGROUND TELEPHONE
- WATER MAIN
- WATER CURB VALVE
- CONCRETE FILLD STEEL ROLLING

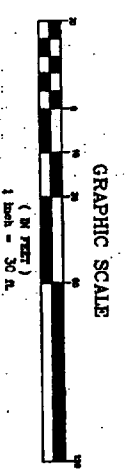

Note: Data on property lines, topography, and utilities taken from surveys by: HPA/CSF 343 Gorman Rd. South Portland, ME 04106; project # 845,01 dated July 1988 and project # 845,01 dated January 2000; and Ticonic Associates 18 Portland North Business Park, Portland, ME 04106 dated June 4, 1990.

FIVE LAYER COMPANY
 3 MARK STREET • PORTLAND, MAINE

LANDSCAPE PLAN
 135 Marginal Way
 Portland, Maine

SCALE: 1"=30'
 DATE: JUNE 20, 2000
 REVISIONS:

PROJECT NO.	DRAWING NO.
	LS-1

NOTE: GRANITE CURBING WITH PUBLIC ROW AND CONCRETE CURBING ON SITE.

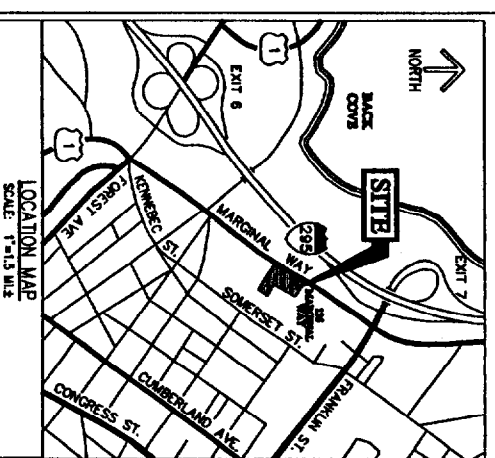
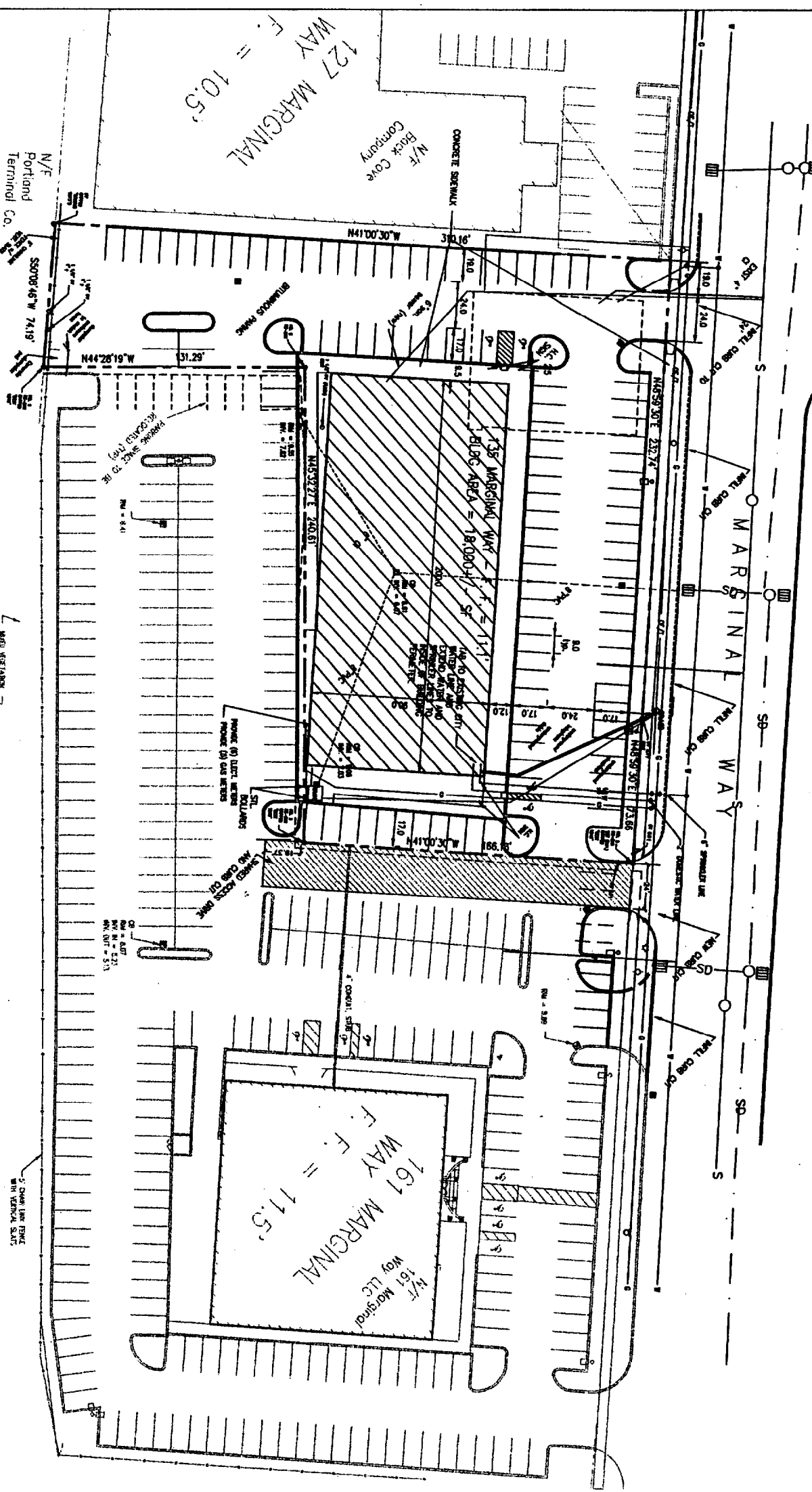

Site Plan Notes:
 1. The site plan shall be developed and/or modified as specified on the site plan. Approval of the Planning Authority or Planning Board shall be required for any alteration or revision from the approved site plan, including, without limitation, topography, drainage, landscaping, installation of roads or law, street access, site location, and siting of parking areas and location and use of buildings.
 2. All proposed utilities shall be underground.
 3. Standards and curbing shall be designed and built with by them means of all street corners, curbsides and driveways in conformance with the City of Portland Landmark and Design Standards and Guidelines.
 4. All erosion and sediment control measures shall be designed in accordance with Maine Erosion and Sediment Control Handbook for Construction, that Handbook's Technical Appendix by the Department of Environmental Protection, Bureau of Water Construction District and State Department of Environmental Protection, March 1991 or latest edition. [Note: this plan shall specify the erosion control devices to be employed (silt fence, hay bale, etc.) as well as their location].
 5. All erosion control measures shall be installed prior to any site excavation or spreading.
 6. All detailed notes on the site not covered by building or paved area shall be submitted with form and seal or other methods as required by Best Management and Practices [see above].
 7. Prior to construction a preconstruction meeting shall be held at the project site with the contractor, development review coordinator, Public Works representatives and owner to review the construction schedule and critical aspects of the site work. At that time, the site/building contractor shall provide three (3) copies of a detailed construction schedule to the attending City representative. It shall be the contractor's responsibility to arrange a meeting separate time for the preconstruction meeting.

CERTIFICATION:
 THE PROPERTY SHOWN ON THIS PLAN CONFORMS TO THE STANDARDS ADOPTED BY THE MAINE STATE BOARD OF LEGISLATIVE FIRE OFFICERS' - CONDITION B STANDARD BUILDING CODE. THIS PLAN IS VALID WITHOUT AN EXPRESSED SEAL IN THIS AREA BY THE PROFESSIONAL LAND SURVEYOR NAMED BELOW. SEE NOTE 3 ABOVE.

DATE: 2-12-2000
 DATE: 2-12-2000
 DATE: 2-12-2000

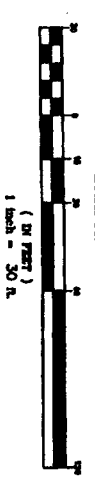
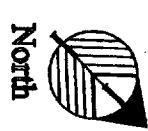

FIVE LIVER COMPANY		PROJECT NO.	DRAWING NO.
5 MILE STREET - PORTLAND, MAINE		SHEET	S-1
SITE PLAN		OF	
135 Marginal Way			
Portland, Maine			
SCALE: 1"=30'	DATE: JUNE 30, 2000		
REVISIONS: MAY 12, 2000			
(indicate A-H with @ symbol)			

LEGEND

---	PROPERTY LINE
---	EXISTING
---	PROPOSED UNDERGROUND UTILITY
---	RAILROAD
---	CADW BASH
---	CONCRETE CURB
---	GRANITE CURB
---	BLANKET MANHOLE
---	EDGE OF CONCRETE SURFACE
---	EDGE OF GRANITE PAVED SURFACE
---	TRUCK
---	6" GAS MAIN
---	8" GAS MAIN
---	12" GAS MAIN
---	18" GAS MAIN
---	24" GAS MAIN
---	30" GAS MAIN
---	36" GAS MAIN
---	42" GAS MAIN
---	48" GAS MAIN
---	54" GAS MAIN
---	60" GAS MAIN
---	66" GAS MAIN
---	72" GAS MAIN
---	78" GAS MAIN
---	84" GAS MAIN
---	90" GAS MAIN
---	96" GAS MAIN
---	102" GAS MAIN
---	108" GAS MAIN
---	114" GAS MAIN
---	120" GAS MAIN
---	126" GAS MAIN
---	132" GAS MAIN
---	138" GAS MAIN
---	144" GAS MAIN
---	150" GAS MAIN
---	156" GAS MAIN
---	162" GAS MAIN
---	168" GAS MAIN
---	174" GAS MAIN
---	180" GAS MAIN
---	186" GAS MAIN
---	192" GAS MAIN
---	198" GAS MAIN
---	204" GAS MAIN
---	210" GAS MAIN
---	216" GAS MAIN
---	222" GAS MAIN
---	228" GAS MAIN
---	234" GAS MAIN
---	240" GAS MAIN
---	246" GAS MAIN
---	252" GAS MAIN
---	258" GAS MAIN
---	264" GAS MAIN
---	270" GAS MAIN
---	276" GAS MAIN
---	282" GAS MAIN
---	288" GAS MAIN
---	294" GAS MAIN
---	300" GAS MAIN
---	306" GAS MAIN
---	312" GAS MAIN
---	318" GAS MAIN
---	324" GAS MAIN
---	330" GAS MAIN
---	336" GAS MAIN
---	342" GAS MAIN
---	348" GAS MAIN
---	354" GAS MAIN
---	360" GAS MAIN
---	366" GAS MAIN
---	372" GAS MAIN
---	378" GAS MAIN
---	384" GAS MAIN
---	390" GAS MAIN
---	396" GAS MAIN
---	402" GAS MAIN
---	408" GAS MAIN
---	414" GAS MAIN
---	420" GAS MAIN
---	426" GAS MAIN
---	432" GAS MAIN
---	438" GAS MAIN
---	444" GAS MAIN
---	450" GAS MAIN
---	456" GAS MAIN
---	462" GAS MAIN
---	468" GAS MAIN
---	474" GAS MAIN
---	480" GAS MAIN
---	486" GAS MAIN
---	492" GAS MAIN
---	498" GAS MAIN
---	504" GAS MAIN
---	510" GAS MAIN
---	516" GAS MAIN
---	522" GAS MAIN
---	528" GAS MAIN
---	534" GAS MAIN
---	540" GAS MAIN
---	546" GAS MAIN
---	552" GAS MAIN
---	558" GAS MAIN
---	564" GAS MAIN
---	570" GAS MAIN
---	576" GAS MAIN
---	582" GAS MAIN
---	588" GAS MAIN
---	594" GAS MAIN
---	600" GAS MAIN
---	606" GAS MAIN
---	612" GAS MAIN
---	618" GAS MAIN
---	624" GAS MAIN
---	630" GAS MAIN
---	636" GAS MAIN
---	642" GAS MAIN
---	648" GAS MAIN
---	654" GAS MAIN
---	660" GAS MAIN
---	666" GAS MAIN
---	672" GAS MAIN
---	678" GAS MAIN
---	684" GAS MAIN
---	690" GAS MAIN
---	696" GAS MAIN
---	702" GAS MAIN
---	708" GAS MAIN
---	714" GAS MAIN
---	720" GAS MAIN
---	726" GAS MAIN
---	732" GAS MAIN
---	738" GAS MAIN
---	744" GAS MAIN
---	750" GAS MAIN
---	756" GAS MAIN
---	762" GAS MAIN
---	768" GAS MAIN
---	774" GAS MAIN
---	780" GAS MAIN
---	786" GAS MAIN
---	792" GAS MAIN
---	798" GAS MAIN
---	804" GAS MAIN
---	810" GAS MAIN
---	816" GAS MAIN
---	822" GAS MAIN
---	828" GAS MAIN
---	834" GAS MAIN
---	840" GAS MAIN
---	846" GAS MAIN
---	852" GAS MAIN
---	858" GAS MAIN
---	864" GAS MAIN
---	870" GAS MAIN
---	876" GAS MAIN
---	882" GAS MAIN
---	888" GAS MAIN
---	894" GAS MAIN
---	900" GAS MAIN
---	906" GAS MAIN
---	912" GAS MAIN
---	918" GAS MAIN
---	924" GAS MAIN
---	930" GAS MAIN
---	936" GAS MAIN
---	942" GAS MAIN
---	948" GAS MAIN
---	954" GAS MAIN
---	960" GAS MAIN
---	966" GAS MAIN
---	972" GAS MAIN
---	978" GAS MAIN
---	984" GAS MAIN
---	990" GAS MAIN
---	996" GAS MAIN
---	1002" GAS MAIN
---	1008" GAS MAIN
---	1014" GAS MAIN
---	1020" GAS MAIN
---	1026" GAS MAIN
---	1032" GAS MAIN
---	1038" GAS MAIN
---	1044" GAS MAIN
---	1050" GAS MAIN
---	1056" GAS MAIN
---	1062" GAS MAIN
---	1068" GAS MAIN
---	1074" GAS MAIN
---	1080" GAS MAIN
---	1086" GAS MAIN
---	1092" GAS MAIN
---	1098" GAS MAIN
---	1104" GAS MAIN
---	1110" GAS MAIN
---	1116" GAS MAIN
---	1122" GAS MAIN
---	1128" GAS MAIN
---	1134" GAS MAIN
---	1140" GAS MAIN
---	1146" GAS MAIN
---	1152" GAS MAIN
---	1158" GAS MAIN
---	1164" GAS MAIN
---	1170" GAS MAIN
---	1176" GAS MAIN
---	1182" GAS MAIN
---	1188" GAS MAIN
---	1194" GAS MAIN
---	1200" GAS MAIN
---	1206" GAS MAIN
---	1212" GAS MAIN
---	1218" GAS MAIN
---	1224" GAS MAIN
---	1230" GAS MAIN
---	1236" GAS MAIN
---	1242" GAS MAIN
---	1248" GAS MAIN
---	1254" GAS MAIN
---	1260" GAS MAIN
---	1266" GAS MAIN
---	1272" GAS MAIN
---	1278" GAS MAIN
---	1284" GAS MAIN
---	1290" GAS MAIN
---	1296" GAS MAIN
---	1302" GAS MAIN
---	1308" GAS MAIN
---	1314" GAS MAIN
---	1320" GAS MAIN
---	1326" GAS MAIN
---	1332" GAS MAIN
---	1338" GAS MAIN
---	1344" GAS MAIN
---	1350" GAS MAIN
---	1356" GAS MAIN
---	1362" GAS MAIN
---	1368" GAS MAIN
---	1374" GAS MAIN
---	1380" GAS MAIN
---	1386" GAS MAIN
---	1392" GAS MAIN
---	1398" GAS MAIN
---	1404" GAS MAIN
---	1410" GAS MAIN
---	1416" GAS MAIN
---	1422" GAS MAIN
---	1428" GAS MAIN
---	1434" GAS MAIN
---	1440" GAS MAIN
---	1446" GAS MAIN
---	1452" GAS MAIN
---	1458" GAS MAIN
---	1464" GAS MAIN
---	1470" GAS MAIN
---	1476" GAS MAIN
---	1482" GAS MAIN
---	1488" GAS MAIN
---	1494" GAS MAIN
---	1500" GAS MAIN
---	1506" GAS MAIN
---	1512" GAS MAIN
---	1518" GAS MAIN
---	1524" GAS MAIN
---	1530" GAS MAIN
---	1536" GAS MAIN
---	1542" GAS MAIN
---	1548" GAS MAIN
---	1554" GAS MAIN
---	1560" GAS MAIN
---	1566" GAS MAIN
---	1572" GAS MAIN
---	1578" GAS MAIN
---	1584" GAS MAIN
---	1590" GAS MAIN
---	1596" GAS MAIN
---	1602" GAS MAIN
---	1608" GAS MAIN
---	1614" GAS MAIN
---	1620" GAS MAIN
---	1626" GAS MAIN
---	1632" GAS MAIN
---	1638" GAS MAIN
---	1644" GAS MAIN
---	1650" GAS MAIN
---	1656" GAS MAIN
---	1662" GAS MAIN
---	1668" GAS MAIN
---	1674" GAS MAIN
---	1680" GAS MAIN
---	1686" GAS MAIN
---	1692" GAS MAIN
---	1698" GAS MAIN
---	1704" GAS MAIN
---	1710" GAS MAIN
---	1716" GAS MAIN
---	1722" GAS MAIN
---	1728" GAS MAIN
---	1734" GAS MAIN
---	1740" GAS MAIN
---	1746" GAS MAIN
---	1752" GAS MAIN
---	1758" GAS MAIN
---	1764" GAS MAIN
---	1770" GAS MAIN
---	1776" GAS MAIN
---	1782" GAS MAIN
---	1788" GAS MAIN
---	1794" GAS MAIN
---	1800" GAS MAIN
---	1806" GAS MAIN
---	1812" GAS MAIN
---	1818" GAS MAIN
---	1824" GAS MAIN
---	1830" GAS MAIN
---	1836" GAS MAIN
---	1842" GAS MAIN
---	1848" GAS MAIN
---	1854" GAS MAIN
---	1860" GAS MAIN
---	1866" GAS MAIN
---	1872" GAS MAIN
---	1878" GAS MAIN
---	1884" GAS MAIN
---	1890" GAS MAIN
---	1896" GAS MAIN
---	1902" GAS MAIN
---	1908" GAS MAIN
---	1914" GAS MAIN
---	1920" GAS MAIN
---	1926" GAS MAIN
---	1932" GAS MAIN
---	1938" GAS MAIN
---	1944" GAS MAIN
---	1950" GAS MAIN
---	1956" GAS MAIN
---	1962" GAS MAIN
---	1968" GAS MAIN
---	1974" GAS MAIN
---	1980" GAS MAIN
---	1986" GAS MAIN
---	1992" GAS MAIN
---	1998" GAS MAIN
---	2004" GAS MAIN
---	2010" GAS MAIN
---	2016" GAS MAIN
---	2022" GAS MAIN
---	2028" GAS MAIN
---	2034" GAS MAIN
---	2040" GAS MAIN
---	2046" GAS MAIN
---	2052" GAS MAIN
---	2058" GAS MAIN
---	2064" GAS MAIN
---	2070" GAS MAIN
---	2076" GAS MAIN
---	2082" GAS MAIN
---	2088" GAS MAIN
---	2094" GAS MAIN
---	2100" GAS MAIN
---	2106" GAS MAIN
---	2112" GAS MAIN
---	2118" GAS MAIN
---	2124" GAS MAIN
---	2130" GAS MAIN
---	2136" GAS MAIN
---	2142" GAS MAIN
---	2148" GAS MAIN
---	2154" GAS MAIN
---	2160" GAS MAIN
---	2166" GAS MAIN
---	2172" GAS MAIN
---	2178" GAS MAIN
---	2184" GAS MAIN
---	2190" GAS MAIN
---	2196" GAS MAIN
---	2202" GAS MAIN
---	2208" GAS MAIN
---	2214" GAS MAIN
---	2220" GAS MAIN
---	2226" GAS MAIN
---	2232" GAS MAIN
---	2238" GAS MAIN
---	2244" GAS MAIN
---	2250" GAS MAIN
---	2256" GAS MAIN
---	2262" GAS MAIN
---	2268" GAS MAIN
---	2274" GAS MAIN
---	2280" GAS MAIN
---	2286" GAS MAIN
---	2292" GAS MAIN
---	2298" GAS MAIN
---	2304" GAS MAIN
---	2310" GAS MAIN
---	2316" GAS MAIN
---	2322" GAS MAIN
---	2328" GAS MAIN
---	2334" GAS MAIN
---	2340" GAS MAIN
---	2346" GAS MAIN
---	2352" GAS MAIN
---	2358" GAS MAIN
---	2364" GAS MAIN
---	2370" GAS MAIN
---	2376" GAS MAIN
---	2382" GAS MAIN
---	2388" GAS MAIN
---	2394" GAS MAIN
---	2400" GAS MAIN
---	2406" GAS MAIN
---	2412" GAS MAIN
---	2418" GAS MAIN
---	2424" GAS MAIN
---	2430" GAS MAIN
---	2436" GAS MAIN
---	2442" GAS MAIN
---	2448" GAS MAIN
---	2454" GAS MAIN
---	2460" GAS MAIN
---	2466" GAS MAIN
---	2472" GAS MAIN
---	2478" GAS MAIN
---	2484" GAS MAIN
---	2490" GAS MAIN
---	2496" GAS MAIN
---	2502" GAS MAIN
---	2508" GAS MAIN
---	2514" GAS MAIN
---	2520" GAS MAIN
---	2526" GAS MAIN

RE: INSTATEMENT **PERMIT ISSUED**

City of Portland, Maine - Building or Use Permit Application

389 Congress Street, 04101 Tel: (207) 874-8703, Fax: (207) 874-8716

Permit No: 01-0712	Issue Date: JUN 6 2002	CBL: 025 B005001
-----------------------	----------------------------------	---------------------

Location of Construction: 135 Marginal Way	Owner Name: Five Liver Company	Owned Address: 5 Milk Street, Portland, ME 04101	Phone: 207-7726404
Business Name: n/a	Contractor Name: Allied/Cook Construction Corp.	Contractor Address: PO Box 1396 Portland	Phone: 2077722888
Lessee/Buyer's Name: n/a	Phone: n/a	Permit Type: Commercial	Zone:

Past Use: Commercial/Retail	Proposed Use: Commercial/ Retail Office; Build new 88' x 198' Building, new parking lot, landscaping, curb cuts. Site Plan # 2000-0142.	Permit Fee: \$4,068.00	Cost of Work: \$674,000.00	CEO District: 1
---------------------------------------	---	----------------------------------	--------------------------------------	---------------------------

Proposed Project Description: Build new 88' x 198' Building	<table border="1" style="width: 100%; border-collapse: collapse;"> <tr> <td style="width: 50%; padding: 2px;">FIRE DEPT: <input type="checkbox"/> Approved <input type="checkbox"/> Denied <i>PREVIOUSLY APPROVED SEE ATTACHED</i></td> <td style="width: 50%; padding: 2px;">INSPECTION: Use Group: Type: <i>PREVIOUSLY APPROVED SEE ATTACHED</i></td> </tr> <tr> <td style="padding: 2px;">Signature:</td> <td style="padding: 2px;">Signature:</td> </tr> </table>	FIRE DEPT: <input type="checkbox"/> Approved <input type="checkbox"/> Denied <i>PREVIOUSLY APPROVED SEE ATTACHED</i>	INSPECTION: Use Group: Type: <i>PREVIOUSLY APPROVED SEE ATTACHED</i>	Signature:	Signature:
FIRE DEPT: <input type="checkbox"/> Approved <input type="checkbox"/> Denied <i>PREVIOUSLY APPROVED SEE ATTACHED</i>	INSPECTION: Use Group: Type: <i>PREVIOUSLY APPROVED SEE ATTACHED</i>				
Signature:	Signature:				

Permit Taken By: gg	Date Applied For: 06/06/2001	Zoning Approval
-------------------------------	--	------------------------

<ol style="list-style-type: none"> 1. This permit application does not preclude the Applicant(s) from meeting applicable State and Federal Rules. 2. Building permits do not include plumbing, septic or electrical work. 3. Building permits are void if work is not started within six (6) months of the date of issuance. False information may invalidate a building permit and stop all work.. 	<table border="1" style="width: 100%; border-collapse: collapse;"> <tr> <th style="text-align: left; padding: 2px;">Special Zone or Reviews</th> </tr> <tr> <td style="padding: 2px;"><input type="checkbox"/> Shoreland</td> </tr> <tr> <td style="padding: 2px;"><input type="checkbox"/> Wetland</td> </tr> <tr> <td style="padding: 2px;"><input type="checkbox"/> Flood Zone</td> </tr> <tr> <td style="padding: 2px;"><input type="checkbox"/> Subdivision</td> </tr> <tr> <td style="padding: 2px;"><input type="checkbox"/> Site Plan</td> </tr> <tr> <td style="padding: 2px;">Maj <input type="checkbox"/> Minor <input type="checkbox"/> MM <input type="checkbox"/></td> </tr> <tr> <td style="padding: 2px;">Date: <i>PREVIOUSLY APPROVED</i></td> </tr> </table>	Special Zone or Reviews	<input type="checkbox"/> Shoreland	<input type="checkbox"/> Wetland	<input type="checkbox"/> Flood Zone	<input type="checkbox"/> Subdivision	<input type="checkbox"/> Site Plan	Maj <input type="checkbox"/> Minor <input type="checkbox"/> MM <input type="checkbox"/>	Date: <i>PREVIOUSLY APPROVED</i>	<table border="1" style="width: 100%; border-collapse: collapse;"> <tr> <th style="text-align: left; padding: 2px;">Zoning Appeal</th> </tr> <tr> <td style="padding: 2px;"><input type="checkbox"/> Variance</td> </tr> <tr> <td style="padding: 2px;"><input type="checkbox"/> Miscellaneous</td> </tr> <tr> <td style="padding: 2px;"><input type="checkbox"/> Conditional Use</td> </tr> <tr> <td style="padding: 2px;"><input type="checkbox"/> Interpretation</td> </tr> <tr> <td style="padding: 2px;"><input type="checkbox"/> Approved</td> </tr> <tr> <td style="padding: 2px;"><input type="checkbox"/> Denied</td> </tr> <tr> <td style="padding: 2px;">Date:</td> </tr> </table>	Zoning Appeal	<input type="checkbox"/> Variance	<input type="checkbox"/> Miscellaneous	<input type="checkbox"/> Conditional Use	<input type="checkbox"/> Interpretation	<input type="checkbox"/> Approved	<input type="checkbox"/> Denied	Date:	<table border="1" style="width: 100%; border-collapse: collapse;"> <tr> <th style="text-align: left; padding: 2px;">Historic Preservation</th> </tr> <tr> <td style="padding: 2px;"><input type="checkbox"/> Not in District or Landmark</td> </tr> <tr> <td style="padding: 2px;"><input type="checkbox"/> Does Not Require Review</td> </tr> <tr> <td style="padding: 2px;"><input type="checkbox"/> Requires Review</td> </tr> <tr> <td style="padding: 2px;"><input type="checkbox"/> Approved</td> </tr> <tr> <td style="padding: 2px;"><input type="checkbox"/> Approved w/Conditions</td> </tr> <tr> <td style="padding: 2px;"><input type="checkbox"/> Denied</td> </tr> <tr> <td style="padding: 2px;">Date:</td> </tr> </table>	Historic Preservation	<input type="checkbox"/> Not in District or Landmark	<input type="checkbox"/> Does Not Require Review	<input type="checkbox"/> Requires Review	<input type="checkbox"/> Approved	<input type="checkbox"/> Approved w/Conditions	<input type="checkbox"/> Denied	Date:
Special Zone or Reviews																											
<input type="checkbox"/> Shoreland																											
<input type="checkbox"/> Wetland																											
<input type="checkbox"/> Flood Zone																											
<input type="checkbox"/> Subdivision																											
<input type="checkbox"/> Site Plan																											
Maj <input type="checkbox"/> Minor <input type="checkbox"/> MM <input type="checkbox"/>																											
Date: <i>PREVIOUSLY APPROVED</i>																											
Zoning Appeal																											
<input type="checkbox"/> Variance																											
<input type="checkbox"/> Miscellaneous																											
<input type="checkbox"/> Conditional Use																											
<input type="checkbox"/> Interpretation																											
<input type="checkbox"/> Approved																											
<input type="checkbox"/> Denied																											
Date:																											
Historic Preservation																											
<input type="checkbox"/> Not in District or Landmark																											
<input type="checkbox"/> Does Not Require Review																											
<input type="checkbox"/> Requires Review																											
<input type="checkbox"/> Approved																											
<input type="checkbox"/> Approved w/Conditions																											
<input type="checkbox"/> Denied																											
Date:																											

CERTIFICATION

I hereby certify that I am the owner of record of the named property, or that the proposed work is authorized by the owner of record and that I have been authorized by the owner to make this application as his authorized agent and I agree to conform to all applicable laws of this jurisdiction. In addition, if a permit for work described in the application is issued, I certify that the code official's authorized representative shall have the authority to enter all areas covered by such permit at any reasonable hour to enforce the provision of the code(s) applicable to such permit.

SIGNATURE OF APPLICANT	ADDRESS	DATE	PHONE
------------------------	---------	------	-------

RESPONSIBLE PERSON IN CHARGE OF WORK, TITLE	DATE	PHONE
---	------	-------

City of Portland, Maine - Building or Use Permit Application

389 Congress Street, 04101 Tel: (207) 874-8703, Fax: (207) 874-8716

Permit No: 01-0712	Issue Date: AUG 30	CBL: 025 B005001
-----------------------	------------------------------	---------------------

Location of Construction: 135 Marginal Way	Owner Name: Five Liver Company	Owner Address: 5 Milk St Portland, Me 04101	Phone: 207-7726404
Business Name: n/a	Contractor Name: Allied/Cook Construction Corp.	Contractor Address: PO Box 1396 Portland	Phone: 2077722888
Lessee/Buyer's Name: n/a	Phone: n/a	Permit Type: Additions - Commercial	Zone: B-5

Past Use: Commercial/Retail	Proposed Use: Commercial/ Retail Office; Build new 88' x 198' Building, new parking lot, landscaping, curb cuts.	Permit Fee: 406800	Cost of Work: \$674,000.00	CEO District: 1
---------------------------------------	--	------------------------------	--------------------------------------	---------------------------

Proposed Project Description: Build new 88' x 198' Building	FIRE DEPT: <input checked="" type="checkbox"/> Approved <input type="checkbox"/> Denied	INSPECTION: Use Group: Type: 2008/06/1999 PERMIT ISSUED WITH REQUIREMENTS
	Signature: <i>WMM</i>	Signature: <i>[Signature]</i>
	PEDESTRIAN ACTIVITIES DISTRICT (P.A.D.)	
	Action: <input type="checkbox"/> Approved <input type="checkbox"/> Approved w/Conditions <input checked="" type="checkbox"/> Denied	
	Signature:	Date:

Permit Taken By: gg	Date Applied For: 06/06/2001	Zoning Approval	
-------------------------------	--	------------------------	--

<ol style="list-style-type: none"> This permit application does not preclude the Applicant(s) from meeting applicable State and Federal Rules. Building permits do not include plumbing, septic or electrical work. Building permits are void if work is not started within six (6) months of the date of issuance. False information may invalidate a building permit and stop all work.. 	Special Zone or Reviews <input type="checkbox"/> Shoreland <i>N/A</i> <input type="checkbox"/> Wetland <input type="checkbox"/> Flood Zone <i>April 13 zone C</i> <input type="checkbox"/> Subdivision <input checked="" type="checkbox"/> Site Plan #2000-0142 Maj <input checked="" type="checkbox"/> Minor <input type="checkbox"/> MM <input type="checkbox"/> Date: <i>OK with conditions</i>	Zoning Appeal <input type="checkbox"/> Variance <input type="checkbox"/> Miscellaneous <input type="checkbox"/> Conditional Use <input type="checkbox"/> Interpretation <input type="checkbox"/> Approved <input type="checkbox"/> Denied Date:	Historic Preservation <input checked="" type="checkbox"/> Not in District or Landmark <input type="checkbox"/> Does Not Require Review <input type="checkbox"/> Requires Review <input type="checkbox"/> Approved <input type="checkbox"/> Approved w/Conditions <input type="checkbox"/> Denied Date: <i>9</i>
---	--	---	---

*20 June 10/1 @ 7:50 AM called contractor regarding the permit and the info. I needed. *[Signature]* 7/2/01*

PERMIT ISSUED WITH REQUIREMENTS

CERTIFICATION

I hereby certify that I am the owner of record of the named property, or that the proposed work is authorized by the owner of record and that I have been authorized by the owner to make this application as his authorized agent and I agree to conform to all applicable laws of this jurisdiction. In addition, if a permit for work described in the application is issued, I certify that the code official's authorized representative shall have the authority to enter all areas covered by such permit at any reasonable hour to enforce the provision of the code(s) applicable to such permit.

SIGNATURE OF APPLICANT	ADDRESS	DATE	PHONE
RESPONSIBLE PERSON IN CHARGE OF WORK, TITLE		DATE	PHONE

2000-0142

THIS IS NOT A PERMIT/CONSTRUCTION CANNOT COMMENCE UNTIL THE PERMIT IS ISSUED

All Purpose Building Permit Application

If you or the property owner owes real estate or personal property taxes or user charges on any property within the City, payment arrangements must be made before permits of any kind are accepted.

Location/Address of Construction: 135 MARGINAL WAY

Total Square Footage of Proposed Structure 18,000 SF +/- Square Footage of Lot 62,700 +/- SF

Tax Assessor's Chart, Block & Lot Number: Chart# 025 Block# B Lot# 5
Owner: FIVE LIVER COMPANY
Telephone#: 772-6404

Lessee/Buyer's Name (If Applicable):
Owner's/Purchaser/Lessee Address: P.O. Box 7525, PORTLAND, ME 04112
Cost Of Work: \$674,000 Fee: \$4,068.

Current use: RETAIL
If the location is currently vacant, what was prior use:
Approximately how long has it been vacant:
Proposed use: RETAIL / OFFICE 18,000 SF 88 x 198 Bldg.
Project description: ~~DEMOLISH EXISTING STRUCTURE~~, BUILD NEW (1) STORY BUILDING, NEW PARKING LOT, LANDSCAPING, CURB CUTS, UTILITIES.

Contractor's Name, Address & Telephone: 772-2888
ALLIED/COOK CONSTRUCTION
P.O. Box 1396 PORTLAND ME 04104
Applicants Name, Address & Telephone:
BRUCE KETTLER
P.O. Box 7525; PORTLAND, ME 04112
Who should we contact when the permit is ready: BRUCE KETTLER
Telephone: 772-8286 ext 207 Call
If you would like the permit mailed, what mailing address should we use:
FIVE LIVER COMPANY
P.O. Box 7525
PORTLAND, ME 04112
Rec'd By:
will email Plans

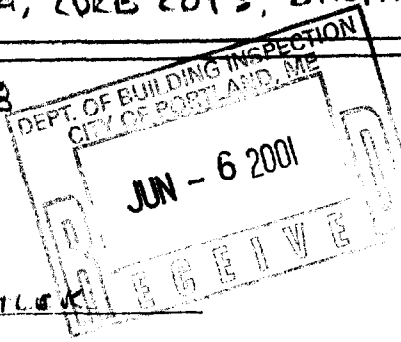

6/6/01
Coff

Paul - Rick Knokland approved
written

Gay 16

025-B-005

Site Review Pre-Application Multi-Family/Attached Single Family Dwellings/Two-Family Dwelling or Commercial Structures and Additions Thereto

In the interest of processing your application in the quickest possible manner, please complete the Information below for Site Plan Review

NOTEIf you or the property owner owes real estate or personal property taxes or user charges on ANY PROPERTY within the City, payment arrangements must be made before permits of any kind are accepted.**

FIVE LIVER COMPANY
Applicant

Application Date
7/11/00

P.O. Box 7525
Applicant's Mailing Address
PORTLAND, ME 04112

Project Name/Description
135 MARGINAL WAY

FORE RIVER COMPANY
Consultant/Agent

Address Of Proposed Site
135 MARGINAL WAY

Applicant/Agent Daytime telephone and FAX

Assessor's Reference, Chart#, Block, Lot# 25-B-1,5,6,22
Portions of

Proposed Development (Check all that apply) New Building Building Addition Change of Use Residential Office Retail
 Manufacturing Warehouse/Distribution Other(Specify) _____

13,000 +/-
Proposed Building Square Footage and /or # of Units

1.44 Acres +/-
Acreage of Site

B5
\$500.00

You must include the following with you application:

- 1) A Copy of Your Deed or Purchase and Sale Agreement
 - 2) 7 sets of Site Plan packages containing the information found in the attached sample plans and checklist. 2 extra Site Plans
- (Section 14-522 of the Zoning Ordinance outlines the process, copies are available for review at the counter, photocopies are \$ 0.25 per page)

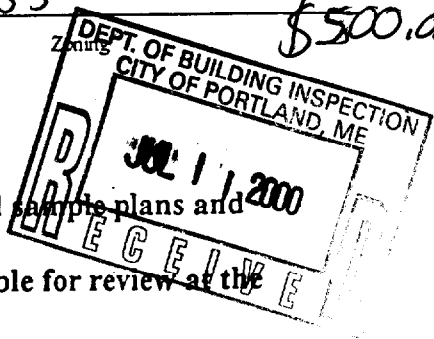

I hereby certify that I am the Owner of record of the named property, or that the proposed work is authorized by the owner of record and that I have been authorized by the owner to make this application as his/her authorized agent. I agree to conform to all applicable laws of this jurisdiction. In addition, if an approval for the proposed project or use described in this application is issued, I certify that the Code Official's authorized representative shall have the authority to enter all areas covered by this approval at any reasonable hour to enforce the provisions of the codes applicable to this approval.

Signature of applicant: <u>Bruce Kiser</u>	Date: <u>7/11/00</u>
--	----------------------

Site Review Fee: Major \$500.00 Minor 400.00

This application is for site review ONLY, a Building Permit application and associated fees will be required prior to construction.

BUILDING PERMIT REPORT

DATE: 20 June 2001 ADDRESS: 135 Marginal Way CBL: 025-B-005
 REASON FOR PERMIT: To Construct an 88' x 198' shell only bldg.
 BUILDING OWNER: Five Live Company
 PERMIT APPLICANT: _____ CONTRACTOR: Allied Rock Co. S.Y.
 USE GROUP: M/B CONSTRUCTION TYPE: 2C CONSTRUCTION COST: 674,000 PERMIT FEES: 4,068

The City's Adopted Building Code (The BOCA National Building Code/1999 with City Amendments)
 The City's Adopted Mechanical Code (The BOCA National Mechanical Code/1993)

CONDITION(S) OF APPROVAL

This permit is being issued with the understanding that the following conditions shall be met: #1, #2, #3, #5, #6, #28, #30, #36, #38, #39, #32

1. This permit does not excuse the applicant from meeting applicable State and Federal rules and laws.
2. Before concrete for foundation is placed, approvals from the Development Review Coordinator and Inspection Services must be obtained. (A 24 hour notice is required prior to inspection) **"ALL LOT LINES SHALL BE CLEARLY MARKED BEFORE CALLING."**
3. Foundation drain shall be placed around the perimeter of a foundation that consists of gravel or crushed stone containing not more than 10 percent material that passes through a No. 4 sieve. The drain shall extend a minimum of 12 inches beyond the outside edge of the footing. The thickness shall be such that the bottom of the drain is not higher than the bottom of the base under the floor, and that the top of the drain is not less than 6 inches above the top of the footing. The top of the drain shall be covered with an approved filter membrane material. Where a drain tile or perforated pipe is used, the invert of the pipe or tile shall not be higher than the floor elevation. The top of joints or top of perforations shall be protected with an approved filter membrane material. The pipe or tile shall be placed on not less than 2" of gravel or crushed stone, and shall be covered with not less than 6" of the same material. Section 1813.5.2
4. Foundations anchors shall be a minimum of 1/2" in diameter, 7" into the foundation wall, minimum of 12" from corners of foundation and a maximum 6' O.C. between bolts. Section 2305.17
5. Waterproofing and dampproofing shall be done in accordance with Section 1813.0 of the building code.
6. Precaution must be taken to protect concrete and masonry. Concrete Sections 1908.9-19.8.10/ Masonry Sections 2111.3-2111.4.
7. It is strongly recommended that a registered land surveyor check all foundation forms before concrete is placed. This is done to verify that the proper setbacks are maintained.
8. Private garages located beneath habitable rooms in occupancies in Use Group R-1, R-2, R-3 or I-1 shall be separated from adjacent interior spaces by fire partitions and floor/ceiling assembly which are constructed with not less than 1-hour fire resisting rating. Private garages attached side-by-side to rooms in the above occupancies shall be completely separated from the interior spaces and the attic area by means of 1/2 inch gypsum board or the equivalent applied to the garage side. (Chapter 4, Section 407.0 of the BOCA/1999)
9. All chimneys and vents shall be installed and maintained as per Chapter 12 of the City's Mechanical Code. (The BOCA National Mechanical Code/1993). Chapter 12 & NFPA 211
10. Sound transmission control in residential building shall be done in accordance with Chapter 12, Section 1214.0 of the City's Building Code.
11. Guardrails & Handrails: A guardrail system is a system of building components located near the open sides of elevated walking surfaces for the purpose of minimizing the possibility of an accidental fall from the walking surface to the lower level. Minimum height all Use Groups 42". In occupancies in Use Group A, B.H-4, I-1, I-2, M, R, public garages and open parking structures, open guards shall have balusters or be of solid material such that a sphere with a diameter of 4" cannot pass through any opening. Guards shall not have an ornamental pattern that would provide a ladder effect. Handrails shall be a minimum of 34" but not more than 38". Exception: Handrails that form part of a guard shall have a height not less than 36 inches (914 mm) and not more than 42 inches (1067 mm). Handrail grip size shall have a circular cross section with an outside diameter of at least 1 1/4" and not greater than 2". (Sections 1021 & 1022.0). Handrails shall be on both sides of stairway. (Section 1014.7)
12. Headroom in habitable space is a minimum of 7'6". (Section 1204.0)
13. Stair construction in Use Group R-3 & R-4 is a minimum of 10" tread and 7 3/4" maximum rise. All other Use Group minimum 11" tread, 7" maximum rise. (Section 1014.0)
14. The minimum headroom in all parts of a stairway shall not be less than 80 inches. (6'8") 1014.4
15. The Minimum required width of a corridor shall be determined by the most restrictive of the criteria under section 1011.3 but not less than 36".
16. Every sleeping room below the fourth story in buildings of Use Groups R and I-1 shall have at least one operable window or exterior door approved for emergency egress or rescue. The units must be operable from the inside without the use of special knowledge or separate tools. Where windows are provided as means of egress or rescue they shall have a sill height not more than 44 inches (1118mm) above the floor. All egress or rescue windows from sleeping rooms shall have a minimum net clear opening height dimension of 24 inches (610mm). The minimum net clear opening width dimension shall be 20 inches (508mm), and a minimum net clear opening of 5.7 sq. ft. (Section 1010.4)
17. Each apartment shall have access to two (2) separate, remote and approved means of egress. A single exit is acceptable when it exits directly from the apartment to the building exterior with no communications to other apartment units. (Section 1010.1)
18. All vertical openings shall be enclosed with construction having a fire rating of at least one (1) hour, including fire doors with self closure's. (Over 3 stories in height requirements for fire rating is two (2) hours. (Section 710.0)
19. The boiler shall be protected by enclosing with (1) hour fire rated construction including fire doors and ceiling, or by providing automatic extinguishment. (Table 302.1.1)

6/6/01

20. All single and multiple station smoke detectors shall be of an approved type and shall be installed in accordance with the provisions of the City's Building Code Chapter 9, Section 920.2 (BOCA National Building Code/1999), and Chapter 10 & 11. (Smoke detectors shall be installed and maintained at the following locations):

- In the immediate vicinity of bedrooms
- In all bedrooms
- In each story within a dwelling unit, including basements

21. A portable fire extinguisher shall be located as per NFPA #10. They shall bear the label of an approved agency and be of an approved type. (Section 921.0)

22. The Fire Alarm System shall be installed and maintained to NFPA #72 Standard.

23. The Sprinkler System shall be installed and maintained to NFPA #13 Standard.

24. All exit signs, lights and means of egress lighting shall be done in accordance with Chapter 10 Section & Subsections 1023.0 & 1024.0 of the City's Building Code. (The BOCA National Building Code/1999)

25. Section 25 - 135 of the Municipal Code for the City of Portland states, "No person or utility shall be granted a permit to excavate or open any street or sidewalk from the time of November 15 of each year to April 15 of the following year".

26. The builder of a facility to which Section 4594-C of the Maine State Human Rights Act Title 5 MRSA refers, shall obtain a certification from a design professional that the plans commencing construction of the facility, the builder shall submit the certification the Division of Inspection Services.

27. Ventilation and access shall meet the requirements of Chapter 12 Sections 1210.0 and 1211.0 of the City's Building Code. (Crawl spaces & attics).

* 28. All electrical, plumbing and HVAC permits must be obtained by Master Licensed holders of their trade. No closing in of walls until all electrical (min. 72 hours notice) and plumbing inspections have been done.

29. All requirements must be met before a final Certificate of Occupancy is issued.

30. All building elements shall meet the fastening schedule as per Table 2305.2 of the City's Building Code (The BOCA National Building Code/1996).

31. Ventilation of spaces within a building shall be done in accordance with the City's Mechanical code (The BOCA National Mechanical Code/1993). (Chapter M-16)

32. Please read and implement the attached Land Use Zoning report requirements. *All the conditions and requirements on the attached site development sheets shall be met*

33. Boring, cutting and notching shall be done in accordance with Sections 2305.3, 2305.3.1, 2305.4.4 and 2305.5.1 of the City's Building Code.

34. Bridging shall comply with Section 2305.16.

35. Glass and glazing shall meet the requirements of Chapter 24 of the building code. (Safety Glazing Section 2406.0)

36. All flashing shall comply with Section 1406.3.10.

37. All signage shall be done in accordance with Section 3102.0 signs of the City's Building Code, (The BOCA National Building Code/1999).

* ~~38. Find attached (3) three construction documents that shall be completed by the professional designer~~

* ~~39. This permit is for the shell only of this bldg. a separate permit is required to finish this bldg.~~

* ~~46. This project will require State Fire Marshal's Office approval~~

* ~~41. This proposed project will also require special inspection as per section 1705.0 (see attached)~~

[Signature]
 Samuel Hoffses, Building Inspector
 Cf. L. McDougall, PFD
 Marge Schmuuckal, Zoning Administrator
 Michael Nugent, Inspection Service Manager
26414

PSH 10/1/00

**This permit is herewith issued, on the basis of plans submitted and conditions placed on these plans, any deviations shall require a separate approval.

***THIS PERMIT HAS BEEN ISSUED WITH THE UNDERSTANDING THAT ALL THE CONDITIONS OF THE APPROVAL SHALL BE COMPLETED. THEREFORE, BEFORE THE WORK IS COMPLETED A REVISED PLAN OR STATEMENT FROM THE PERMIT HOLDER SHALL BE SUBMITTED TO THIS OFFICE SHOWING OR EXPLAINING THAT THE CONDITIONS HAVE BEEN MET. IF THIS REQUIREMENT IS NOT RECEIVED YOUR CERTIFICATE OF OCCUPANCY SHALL BE WITHHELD. (You Shall Call for Inspections)

****ALL PLANS THAT REQUIRE A PROFESSIONAL DESIGNER'S SEAL, (AS PER SECTION 114.0 OF THE BUILDING CODE) SHALL ALSO BE PRESENTED TO THIS DIVISION ON AUTO CAD LT. 2000, DXF FORMAT OR EQUIVALENT.

*****CERTIFICATE OF OCCUPANCY FEE \$50.00

NOTES: N.R. — Not required
N.A. — Not applicable

ADMINISTRATION (Chapter 1)

NO Complete construction documents (107.5, 107.6, 107.7) yes Signed/sealed construction documents (107.7, 114.1)
Shell of bldg. only

BUILDING PLANNING (Chapters 3, 4, 5, 6)

USE OR OCCUPANCY CLASSIFICATION (302.0-313.0)

✓ Single Use Group NO Specific occupancy areas (302.1.1)
NA Mixed Use Groups NA Accessory areas (302.1.2)

GENERAL BUILDING LIMITATIONS (Chapters 5 & 6)

Apply Case 1 to determine the allowable height and area and permitted types of construction for a building containing a single use group or nonseparated mixed use groups. Apply Case 2 to determine the allowable height and area and permitted types of construction for a building containing separated mixed use groups.

AREA MODIFICATIONS TO TABLE 503

% of Allowable tabular area (Table 503)	<u>100%</u>
% Reduction for height (Table 506.4)	<u>- 0%</u>
% Increase for open perimeter (506.2)	<u>+ 150%</u>
% Increase for automatic sprinklers (506.3)	<u>+ 200%</u>
Total percentage factor	<u>= 350%</u>
Conversion factor	<u>$\frac{350\%}{100\%} = 3.50$</u> (Total percentage factor/100%)

Open perimeter (506.2)	<u>198</u> North	<u>88</u> East	<u>198</u> South	<u>88</u> West
Open perim. <u>572</u> ft.	Perimeter <u>572</u> ft.			
% Open perimeter =	<u>$\frac{(572/572) \times 100\% = 100}{(Open\ perim./perim.) \times 100\%}$</u>			
% Tab. area increase = (506.2)	<u>$\frac{100 \cdot 25 = 150\%}{2 \times (\% Open\ perim. - 25\%)}$</u>			

CASE 1 — SINGLE USE OR NONSEPARATED MIXED USE GROUPS (313.1.1, 503.0)

Using Table 503, identify the allowable height and area of the single use group or the most restrictive of the nonseparated mixed use groups. Construction types that provide an allowable tabular area equal to or greater than the adjusted floor area and allowable heights (as modified by Section 504.0) equal to or greater than the actual building height are permitted.

Actual floor area <u>17,424</u> ft. ²		Actual building height <u>20</u> feet	1 stories
Adjusted floor area* <u>4978</u> ft. ²		Allowable building height <u>30</u> feet	2 stories

*Adjusted floor area = actual floor area/conversion factor

Permitted types of construction 5A Type of construction assumed for review (602.3) 2C

CASE 2 — MIXED USE SEPARATED USE GROUPS

Using Table 503, identify the allowable height and area of each of the separated use groups within the building. Construction types that provide, for each story of the building, tabular areas which result in a sum of the ratios of 1.00 or less and allowable heights (as modified by Section 504.0) equal to or greater than the actual height of the use group are permitted.

Story	Use Group	Actual floor area	Adjusted floor area*	Actual height	Allowable height (Table 503)
_____	_____	_____ ft ²	_____ ft ²	_____ ft _____ stories	_____ ft _____ stories
_____	NA/A	_____ ft ²	_____ ft ²	_____ ft _____ stories	_____ ft _____ stories
_____		_____ ft ²	_____ ft ²	_____ ft _____ stories	_____ ft _____ stories
_____		_____ ft ²	_____ ft ²	_____ ft _____ stories	_____ ft _____ stories
_____		_____ ft ²	_____ ft ²	_____ ft _____ stories	_____ ft _____ stories
_____		_____ ft ²	_____ ft ²	_____ ft _____ stories	_____ ft _____ stories
_____		_____ ft ²	_____ ft ²	_____ ft _____ stories	_____ ft _____ stories
_____		_____ ft ²	_____ ft ²	_____ ft _____ stories	_____ ft _____ stories
_____		_____ ft ²	_____ ft ²	_____ ft _____ stories	_____ ft _____ stories

*Adjusted floor area = actual floor area/conversion factor

$$\sum \frac{\text{Adjusted floor area}^*}{\text{Allowable area (Table 503)}} = \underline{\quad} + \underline{\quad} + \underline{\quad} + \underline{\quad} = \underline{\quad} \leq 1.00$$

Permitted types of construction _____ Type of construction assumed for review (602.3) _____

UNLIMITED AREA ONE-STORY BUILDINGS

- M Use group classification (507.1) _____ School buildings (507.1.1)
- _____ Building height (story, feet) (507.1) _____ High-hazard use groups (507.1.2)
- 2C Type of construction (507.1) _____ Exterior walls (507.2)
- _____ Automatic sprinkler system (507.1, 904.11)

MEZZANINES

- NA Area limitation (505.2) NA Openness (505.4)
- NA Egress (505.3)

SPECIAL USE AND OCCUPANCY (Chapter 4)

COVERED MALL BUILDINGS

- NA Tenant separations (402.4)
- _____ Egress (402.5)
- _____ Mall width (402.6)
- _____ Structural elements (402.7)
- _____ Roof coverings (402.8)
- _____ A-1, A-2 occupancy (402.9)
- _____ Automatic sprinkler system (402.10)
- _____ Standpipes (402.11)
- _____ Fire department access (402.12)
- _____ Kiosk requirements (402.14)

- 1 Parking structures (402.15)

HIGH-RISE BUILDINGS

- NA Automatic sprinkler system (403.2)
- _____ Alternative sprinkler modifications (403.3)
- _____ Automatic fire detection (403.4)
- _____ Voice/alarm signaling systems (403.5)
- _____ Fire department communication (403.6)
- _____ Fire command station (403.7)
- _____ Elevators (403.8)
- _____ Standby systems (403.9)
- _____ Stairway doors (403.10)

ATRIUMS

- _____ Automatic sprinkler system (404.2)
- _____ Occupancy (404.3)
- _____ Smoke control (404.4)
- _____ Enclosure (404.5)
- _____ Fire alarm system (404.6)
- _____ Travel distance (404.7)

OTHER SPECIAL USE AND OCCUPANCY

- NA _____ Underground structures (405.0)
- _____ Open parking structures (406.0)

- _____ Private garages (407.0)
- _____ Public garages (408.0)
- _____ Use Group I-2 (409.0)
- _____ Use Group I-3 (410.0)
- _____ Stages and platforms (412.0)
- _____ Special amusement buildings (413.0)
- _____ HPM facilities (416.0)
- _____ Hazardous materials (307.8, 417.0)
- _____ Use Groups H-1, H-2, H-3 and H-4 (418.0)
- _____ Swimming pools (421.0)

FIRE PROTECTION (Chapters 6, 7, 8, 9)

FIRERESISTANT MATERIALS AND CONSTRUCTION (Chapter 7 and Table 602)

Note: Entry in indicates required rating in hours. NC indicates noncombustible construction required.

COMBUSTIBILITY (603.0, 604.0, 605.0, 606.0)

- NC _____ Exterior walls
- NA _____ Interior elements
- NA _____ Roof

CONSTRUCTION DOCUMENTS (703.0)

- NA _____ Fire tests (704.0)

EXTERIOR WALLS (507.2, 705.0, 716.5)

	North	East	South	West
Fire separation distance	<u>50'</u>	<u>50'</u>	<u>50'</u>	<u>50'</u>
Loadbearing	<input type="checkbox"/>	<input checked="" type="checkbox"/>	<input type="checkbox"/>	<input checked="" type="checkbox"/>
Nonloadbearing	<input checked="" type="checkbox"/>	<input type="checkbox"/>	<input checked="" type="checkbox"/>	<input type="checkbox"/>

- Ø _____ Exterior opening protectives (705.3, 706.0)
- Ø _____ Parapet walls (705.6)

FIRE SEPARATION ASSEMBLIES *Shell of bldg. on this permit*

- _____ Exit enclosures (709.0, 710.0, 1014.11)
- _____ Other shafts (709.0, 710.0)
- _____ Mixed use and fire area separations (313.1.2)
- _____ Other separation assemblies (302.1.1, Table 602)

FIRE PARTITIONS

- _____ Exit access corridors (711.0, 1011.4)
- _____ Tenant separations (711.0)
- _____ Dwelling unit separations (711.0)
- _____ Guestroom separations (711.0)

OTHER FIRERESISTANT CONSTRUCTION

- _____ Fire and party walls (707.0 and Table 707.1)
- _____ Smoke barriers (712.0)
- _____ Nonloadbearing partitions (Table 602)
- _____ Interior loadbearing walls, columns, girders, trusses (716.0)
- _____ Supporting construction (716.0)
- _____ Floor construction (713.0, 1006.3.1)
- _____ Roof construction (713.0, 715.0)
- _____ Penetrations (714.0)
- _____ Opening protectives (717.0, 719.0, 720.0)
- _____ Fire dampers (718.0)
- _____ Fireblocking/draftstopping (721.0)
- _____ Thermal and sound-insulating materials (723.0)

INTERIOR FINISHES (Chapter 8)

_____ Smoke development (803.3.2)
 _____ Flame spread (803.4)

_____ Floor finish (805.0, 806.0)

FIRE PROTECTION SYSTEMS (Chapter 9)

FIRE SUPPRESSION SYSTEMS (Where required)

NA Assembly (A-1, A-3, A-4) (904.2)
NA Assembly (A-2) (904.3)
NA Educational (E) (904.4)
NA High-hazard (H) (904.5)
NA Institutional (I) (904.6)
 _____ Mercantile (M), Moderate-hazard storage (S-1), Factory and Industrial (F-1) (904.7)
NA Residential (R-1) (904.8)
NA Residential (R-2) (904.9)
NA Windowless story (904.10)
 _____ Specific occupancy areas (302.1.1, 904.11)
 _____ Covered mall buildings (402.10)
NA High-rise buildings (403.2)
NA Atriums (404.2)
NA Underground structures (405.3)
NA Public garages (408.3.1)
NA Sound stages (411.7)
NA Stages and enclosed platforms (412.6)
NA Special amusement buildings (413.4)
NA HPM facilities (416.4)
NA Paint spray booths and storage rooms (419.3)
1 Unlimited area buildings (507.1)
MA Exit lobbies (1020.3)
NA Drying rooms (2806.4)
NA Waste- and linen-chutes/termination rooms (2807.6)
MA Refuse vaults (2808.4)

FIRE SPRINKLER SYSTEMS

_____ NFPA 13 system (906.2.1)
 _____ NFPA 13R system (906.2.2)
 _____ NFPA 13D system (906.2.3)
 _____ Design (906.3)
 _____ Actuation (906.4)
 _____ Sprinkler alarms (906.5)
 _____ Sprinkler riser (906.7)

LIMITED AREA SPRINKLER SYSTEMS

NA Where permitted (907.2)
 _____ Design (907.3)
 _____ Actuation (907.4)
 _____ Standpipe connection (907.6)
 _____ Domestic supply (907.6.1)
 _____ Cross connection (907.6.2)
 _____ Shutoff valve (907.6.3)

OTHER SUPPRESSION SYSTEMS

NA Water-spray fixed systems (908.0)
 _____ Carbon dioxide extinguishing systems (909.0)
 _____ Dry-chemical extinguishing systems (910.0)
 _____ Foam-extinguishing systems (911.0)
 _____ Halogenated extinguishing systems (912.0)
 _____ Clean agent fire extinguishing systems (913.0)
 _____ Wet-chemical range hood extinguishing systems (914.0)

STANDPIPE SYSTEMS

- _____ Building height (915.2.1)
- _____ Building area (915.2.2)
- / _____ Malls (915.2.3)
- _____ Stages (915.2.4)
- _____ Approved system (915.3, 915.3.1)
- _____ Piping design (915.4)
- _____ Water supply (915.5)
- _____ Control valves (915.6)
- _____ Hose connection (915.7)

FIRE DEPARTMENT CONNECTIONS

- _____ Required (916.1)
- _____ Connections (916.2)

YARD HYDRANTS

- _____ Fire hydrants (917.1)

FIRE ALARM SYSTEMS

- _____ Approval (918.3)
- _____ Assembly (A-4), Educational (E) (918.4.1)
- _____ Business (B)(918.4.2)
- _____ High-hazard (H) (918.4.3)
- _____ Institutional (I) (918.4.4)
- _____ Residential (R-1) (918.4.5)
- _____ Residential (R-2) (918.4.6)
- _____ Location/details (918.5)
- _____ Power supply/wiring (918.6, 918.7)
- _____ Alarm-notification appliances (918.8)
- _____ Voice/alarm signaling system (918.9)

AUTOMATIC FIRE DETECTION SYSTEMS

- _____ Approval (919.3)
- _____ Institutional (I) (919.4.1, 919.4.2, 919.4.3)
- _____ Residential (R-1) (919.4.4)
- _____ Sprinklered buildings exception (919.5)
- _____ Zones (919.6)

SINGLE- AND MULTIPLE-STATION SMOKE DETECTORS

- NA _____ Residential (R-1) (920.3.1)
- _____ Residential (R-2, R-3) (920.3.2)
- _____ Institutional (I-1) (920.3.3)
- _____ Interconnection (920.4)
- _____ Battery backup (920.5)

FIRE EXTINGUISHERS

- _____ Approval (921.1)
- _____ Required (921.2)

SMOKE CONTROL SYSTEMS

- _____ Passive system (922.2.1)
- _____ Mechanical system (922.2.2)
- _____ Smoke removal (922.3)
- _____ Activation (922.4)
- _____ Standby power (922.5)

SMOKE AND HEAT VENTS

- _____ Size and spacing (923.2)

SUPERVISION

- _____ Fire suppression systems (924.1)
- _____ Fire alarm systems (924.2)

MEANS OF EGRESS (continued)

_____	General limitations (1005.0)	_____	Ramps (1016.0)
_____	Air movement in egress elements (1005.7)	_____	Means of egress doorways (1017.0)
_____	Types and location of egress (1006.0)	_____	Number of doorways (1017.2)
_____	Exit access travel distance (1006.5 and Table 1006.5)	_____	Size of doors (1017.3)
_____	Accessible means of egress (1007.0)	_____	Door hardware (1017.4)
_____	Emergency escape (1010.4)	_____	Revolving doors (1018.0)
_____	Exit access passageways and corridors (1011.0)	_____	Horizontal exits (1019.0)
_____	Aisles and accessways (1012.0)	_____	Level of exit discharge passageway (1020.0)
_____	Grandstands (1013.0)	_____	Guards (1021.0)
_____	Interior stairways (1014.1 - 1014.11)	_____	Handrails (1022.0)
_____	Exterior stairways (1014.1 - 1014.10, 1014.12)	_____	Exit signs and lights (1023.0)
_____	Smokeproof enclosures (1015.0)	_____	Means of egress lighting (1024.0)
		_____	Access to roof (1027.0)

ACCESSIBILITY (Chapter 11)

_____	Required (1103.0)	_____	Accessible entrances (1106.0)
_____	Accessible route (1104.0)	_____	Special use groups (1107.0)
_____	Parking facilities (1105.0)	_____	Features and facilities (1108.0)

INTERIOR ENVIRONMENT (Chapter 12)

_____	Room dimensions (1204.0)	_____	Air-borne noise (STC) (1214.2)
_____	Roof spaces (1210.1, 1211.2)	_____	Structure-borne sound (IIC) (1214.3)
_____	Crawl spaces (1210.2, 1211.1)	_____	Ratproofing (1215.0)

BUILDING ENVELOPE (Chapters 14, 15)

EXTERIOR WALL COVERINGS (Chapter 14)

_____	Performance requirements (1403.0)	_____ <i>NA</i>	Combustible material restrictions (1406.0)
_____ <i>k</i>	Wall sidings and veneers (1404.0, 1405.0)		

ROOFS AND ROOF STRUCTURES (Chapter 15)

Performance requirements (1505.0)	Low-slope roof coverings (1507.5)
Fire classification (1506.0)	Flashing (1508.0)
Steep-slope roof coverings (1507.4)	Roof structures (1510.0)

STRUCTURAL SYSTEMS (Chapters 16, 17, 18)

STRUCTURAL LOADS (Chapter 16)

DESIGN LOADS ON CONSTRUCTION DOCUMENTS (1603.1)

Uniformly distributed floor live loads (1603.2, 1606.0)

Floor Area Use	Loads Shown

Live load reduction (1603.2, 1606.7)

Roof live loads (1603.3, 1607.0)

Roof snow loads (1603.4, 1608.0)

Ground snow load, P_g (1608.3)

If $P_g > 10$ psf, flat-roof snow load, P_f (1608.4)

If $P_g > 10$ psf, snow exposure factor, C_e (Table 1608.4)

Sloped roof snowload, P_s (1608.5)

If $P_g > 10$ psf, snow load importance factor, I (Table 1609.5)

Wind loads (1603.5, 1609.0)

Basic wind speed (1609.3)

Wind exposure category (1609.4)

Wind importance factor, I (Table 1609.5)

Wind design pressure, P (1609.7)

Earthquake loads (1603.6, 1610.0)

Peak velocity-related acceleration, A_v (1610.1.3)

Peak acceleration, A_a (1610.1.3)

Seismic hazard exposure group (1610.1.5)

Seismic performance category (1610.1.7)

Soil-profile type (Table 1610.3.1)

Basic structural system and seismic-resisting system (Table 1610.3.3)

Response modification factor, R , and deflection amplification factor, C_d (Table 1610.3.3)

Analysis procedure (1610.4, 1610.5)

Other loads

Attic load (1606.2.2, 1606.2.3)

Partition loads (1606.2.4)

Concentrated loads (1606.3)

Impact loads (1606.6)

Misc. loads (1606.4, 1606.8, 1606.9, 1607.5, 1612.0)

STRUCTURAL DESIGN CALCULATIONS

Submitted for all structural members (107.7)

Signed/sealed (107.7, 114.1)

Deflection limits considered (1604.5)

STRUCTURAL DESIGN CALCULATIONS (continued)

_____	Unbalanced snow loads considered (1608.6)	_____	Internal pressure effects considered (1609.7, 1609.8)
_____	Drift snow loads considered (1608.7)	_____	Components and cladding effects considered (1609.8)
_____	Sliding snow loads considered (1608.8)	_____	Load combinations considered (1613.1)

MATERIAL PERFORMANCE (Chapter 17)

_____	Material performance technical data or BOCA Evaluation Services or National Evaluation Services report supplied (1703.0) Report No. _____	_____	Masonry construction (1705.5)
_____	Owner's special inspection program specified (1705.0)	_____	Wood construction (1705.6)
_____	Prefabricated items (1705.2)	_____	Prepared fill and foundations (1705.7, 1705.8, 1705.9)
_____	Steel construction (1705.3)	_____	Fireresistive materials (1705.12)
_____	Concrete construction (1705.4)	_____	EIFS, wall panels and veneers (1705.10, 1705.13)

FOUNDATIONS AND RETAINING WALLS (Chapter 18)

_____	Soil type (1611.0, 1802.1, 1804.1)	_____	Foundations (1814.0 - 1824.0)
_____	Bearing value (1611.0, 1802.1, 1804.1)	_____	Foundation walls (1611.0, 1812.0)
_____	Soil report (1802.1, 1804.1)	_____	Waterproofing/dampproofing (1813.0)
_____	Prepared fill (1804.1.1)	_____	Retaining walls (1611.0, 1825.0)
_____	Footings (1806.0 - 1811.0)		

STRUCTURAL MATERIALS (Chapters 19, 21, 22, 23)

CONCRETE (Chapter 19)

_____	Plain, reinforced and prestressed concrete design/construction standard specified (1901.1, 1903.1.1)	_____	Minimum concrete strength (Table 1907.1.2[1])
_____	Minimum slab requirements (1905.1)	_____	Cold-weather and hot-weather curing speci- fied (1908.9, 1908.10)

MASONRY (Chapter 21)

_____ ✓	Engineered masonry design/construction standard specified (2101.1.1)	_____ ✓	Cold-weather and hot-weather construction specified (2111.3, 2111.4)
_____ ✓	Empirical masonry design (2101.1.2)	_____ ✓	Fireplaces and chimneys (2103.2, 2113.0 - 2117.0)
_____ ✓	Construction materials (2104.0)	_____ ✓	Glass block (2118.0)
_____ ✓	Mortar type (2104.7)	_____ ✓	

STEEL (Chapter 22)

Structural steel design/construction standard specified (2203.1, 2203.2)	Formed steel design/construction standard specified (2206.1)
Shop drawing preparation specified (2203.4)	Formed steel member identification (2206.6)
Open-web steel joist design/construction standard specified (2205.1)	

WOOD (Chapter 23)

<u>NA</u>	<u>✓</u>
Installation inspections (2301.2)	Seismic bracing (2305.8)
Design/construction standard specified (2303.1)	Foundation anchorage (2305.17)
Grade mark specified (2303.1.1)	Wood structural panels (2307.0)
HEAVY TIMBER CONSTRUCTION	Particleboard (2308.0)
<u>NA</u>	<u>✓</u>
Minimum dimensions (605.1, 2304.0)	Fiberboard (2309.0)
Design/construction standard specified (2304.1)	Fireretardant-treated wood (2310.0)
WOOD FRAME CONSTRUCTION	Decay and termite protection (2311.0)
<u>NA</u>	<u>✓</u>
Fastening and construction details (2305.0, Table 2305.2)	Joist hangers (2312.0)
Wind bracing design required (2305.7)	Prefabricated components (2313.1, 2313.2)
	Metal-plate-connected trusses (2313.3.1, 2313.3.2)

NONSTRUCTURAL MATERIALS (Chapters 24, 25, 26)

GLASS AND GLAZING (Chapter 24)

<u>NA</u>	<u>✓</u>
Skylights (2404.0)	Safety glazing (2405.0, 2406.0, 2407.0)

GYPSUM BOARD AND PLASTER (Chapter 25)

	<u>NA</u>
Gypsum board materials (2503.0, Table 2503.2, Table 2503.3)	Plaster (2504.0, 2505.0, 2506.0)

PLASTIC (Chapter 26)

<u>NA</u>	<u>✓</u>
Approved materials (2601.2)	FOAM PLASTIC (2603.0)
Identification (2601.4)	Labeling (2603.2)
Interior trim (2603.7)	Surface-burning characteristics (2603.3)
Alternative approval (2603.8)	Thermal barrier (2603.4)
	Exterior walls (2603.5, 2603.6)

LIGHT-TRANSMITTING PLASTIC (2603.5, 2604.0)

NA

Diffusing systems (2604.5)

Wall panels (2605.0)

NA

Unprotected openings (2606.0)

Roof panels (2607.0)

Skylight glazing (2608.0)

BUILDING SERVICES (Chapters 28, 30)

MECHANICAL SYSTEMS (Chapter 28)

NA

Waste- and linen-handling systems (2807.0)

NA

Refuse vaults (2808.0)

ELEVATORS AND CONVEYING SYSTEMS (Chapter 30)

NA

Construction standard specified (3001.2)

Elevator emergency operation (3006.2)

Hoistway enclosure (3007.1)

NA

Venting (3007.3 - 3007.6)

Opening protectives (3008.2)

Conveyors and escalators (3010.0, 3011.0)

SPECIAL DEVICES AND CONDITIONS (Chapters 31, 34)

SPECIAL CONSTRUCTION (Chapter 31)

NA

Membrane structures (3103.0)

Flood-resistant construction (3107.0)

Towers (3108.0)

PEDESTRIAN WALKWAYS (3106.0)

NA

Construction and use (3106.1 - 3106.3)

Separation (3106.4)

Local approval (3106.5)

Egress and size (3106.6 - 3106.8)

EXISTING STRUCTURES (Chapter 34) N/A

ADDITIONS, ALTERATIONS OR CHANGE OF OCCUPANCY

NA

General requirements (3402.0)

NA

Structural loads (1614.0, 3402.5)

NA

Accessibility (1110.0, 3402.7)

NA

Additions/alterations (3403.0, 3404.0)

NA

Change of occupancy (1110.3, 3405.0)

NA

Compliance alternative evaluation (3408.0)

BUILDING EVALUATION SUMMARY (Table 3408.7)

Existing use group _____	Proposed use group _____
Year building was constructed _____	Number of stories _____ Height in feet _____
Type of construction _____	Area per floor _____
Percentage of open perimeter _____ %	Percentage of height reduction _____ %
Completely suppressed: Yes _____ No _____	Corridor wall rating _____
Compartmentation: Yes _____ No _____	Required door closers: Yes _____ No _____
Fire-resistance rating of vertical opening enclosures _____	
Type of HVAC system _____, serving number of floors _____	

BUILDING EVALUATION SUMMARY (continued)

Automatic fire detection: Yes _____ No _____, type and location _____
 Fire alarm system: Yes _____ No _____, type _____
 Smoke control: Yes _____ No _____, type _____
 Adequate exit routes: Yes _____ No _____ Dead ends: Yes _____ No _____
 Maximum exit access travel distance _____ Elevator controls: Yes _____ No _____
 Means of egress emergency lighting: Yes _____ No _____ Mixed use groups: Yes _____ No _____

Safety parameters	Fire safety (FS)	Means of egress (ME)	General safety (GS)
3408.6.1 Building height			
3408.6.2 Building area			
3408.6.3 Compartmentation			
3408.6.4 Tenant and dwelling unit separations			
3408.6.5 Corridor walls			
3408.6.6 Vertical openings			
3408.6.7 HVAC systems			
3408.6.8 Automatic fire detection			
3408.6.9 Fire alarm system			
3408.6.10 Smoke control	****		
3408.6.11 Means of egress	****		
3408.6.12 Dead ends	****		
3408.6.13 Max. exit access travel distance	****		
3408.6.14 Elevator control			
3408.6.15 Means of egress emergency lighting	****		
3408.6.16 Mixed use groups		****	
3408.6.17 Sprinklers		+ 2 =	
3408.6.18 Specific occupancy area protection			
Building score — total value			

**** No applicable value to be inserted.

BUILDING SAFETY EVALUATION SCORE (Table 3408.9)

Formula	Table 3408.7	Table 3408.8	Score	Pass	Fail
FS-MFS ≥ 0	_____ (FS)	- _____ (MFS)	= _____	_____	_____
ME-MME ≥ 0	_____ (ME)	- _____ (MME)	= _____	_____	_____
GS-MGS ≥ 0	_____ (GS)	- _____ (MGS)	= _____	_____	_____

FS = Fire Safety
 ME = Means of Egress
 GS = General Safety

MFS = Mandatory Fire Safety
 MME = Mandatory Means of Egress
 MGS = Mandatory General Safety

Applicant: S Live Company

Date: 7/2/01

Address: 135 Marginal Way

C-B-L: 025-B-005

CHECK-LIST AGAINST ZONING ORDINANCE

Date - New

Zone Location - B-5

Interior or corner lot -

Proposed Use/Work - Construct An 88' x 198' shell bldg. for retail office

Sewage Disposal - City

Lot Street Frontage - No min req - 300' shown

Front Yard - None req

Rear Yard - None req

Side Yard - None req

Projections -

Width of Lot - None req

Height - 65' MAX. - 18' scaled

Lot Area - No minimum req - 53,748 # shown per Assessor

Lot Coverage Impervious Surface - 100% Allowed

Area per Family - N/A

Off-street Parking - A-230.5 - None req - 89 spaces shown

Loading Bays - None req

Site Plan - Major # 2000-0142

Shoreland Zoning/Stream Protection - N/A

Flood Plains - Panel 13
Zone C

025-B-005



City of Portland, Maine

389 Congress St., Rm 315
Portland, ME 04101

ACCESSIBILITY CERTIFICATE

TO: Inspector of Buildings City of Portland, Maine
Department of Planning & Urban Development
Division of Housing & Community Services

FROM: CURTIS WALTER STEWART ARCHITECTS

RE: Certificate of Design, HANDICAP ACCESSIBILITY

DATE: 8/30/01

These plans and/or specifications covering construction work on:

- OFFICE BUILDING
- 135 MARCHAL WAY

Have been designed and drawn up by the undersigned, a Maine registered engineer/architect according to State Regulations as adopted by the State of Maine on Handicapped Accessibility.

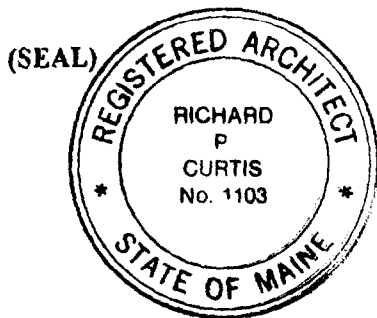

Signature Richard P. Curtis

Title PRESIDENT

Firm CWS ARCHITECTS

Address 434 CUMBERLAND AVENUE
PORTLAND, MAINE 04101

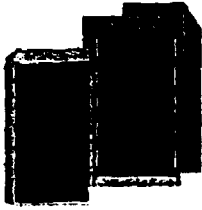

**CITY OF PORTLAND
BUILDING CODE CERTIFICATE**
389 Congress St., Rm 315
Portland, ME 04101

TO: Inspector of Buildings City of Portland, Maine
Department of Planning & Urban Development
Division of Housing & Community Service

FROM: CURTIS WALTER STEWART ARCHITECTS

RE: Certificate of Design

DATE: 8/30/01

These plans and/or specifications covering construction work on:

OFFICE BUILDING - 135 MARGINAL WAY

Have been designed and drawn up by the undersigned, a Maine registered architect/engineer according to the BOCA National Building Code/1999 Fourteenth Edition, and local amendments.

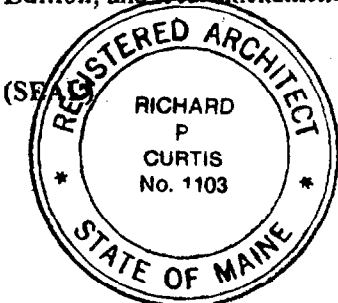

Signature Richard P. Curtis

Title PRESIDENT

Firm CWS ARCHITECTS

Address 134 LUMBERLAND AVE
PORTLAND, MAINE 04101

As per Maine State Law:

\$50,000.00 or more in new construction, repair, expansion, addition, or modification for Building or Structures, shall be prepared by a registered design Professional.

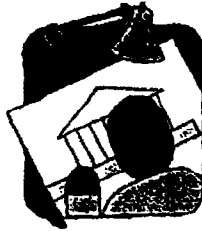

CITY OF PORTLAND MAINE

389 Congress St., Rm 315
Portland, ME 04101
Tel. - 207-874-8704
Fax - 207-874-8716

TO: Inspector of Buildings City of Portland, Maine
Planning & Urban Development
Division of Housing & Community Services

FROM DESIGNER: CURTIS WALTER STEWART ARCHITECTS
434 CUMBERLAND AVE. PORTLAND, ME 04101

DATE: 8/30/01

Job Name: OFFICE BUILDING

Address of Construction: 135 MARSHALL WAY

THE BOCA NATIONAL BUILDING CODE/1999 Fourteenth EDITION
Construction project was designed according to the building code criteria listed below:

Building Code and Year BOCA 1999 Use Group Classification(s) B

Type of Construction 2L Bldg. Height 20'0" Bldg. Sq. Footage 17,940 SF

Seismic Zone _____ Group Class. I/C

Roof Snow Load Per Sq. Ft. 14.2 Dead Load Per Sq. Ft. _____

Basic Wind Speed (mph) 85 Effective Velocity Pressure Per Sq. Ft. 17.0

Floor Live Load Per Sq. Ft. 100 PPF ON FLOOR SLAB

Structure has full sprinkler system? Yes No _____ Alarm System? Yes No _____
Sprinkler & Alarm systems must be installed according to BOCA and NFPA Standards with approval from the Portland Fire Department.

Is structure being considered unlimited area building: Yes _____ No

If mixed use, what subsection of 313 is being considered N/A

List Occupant loading for each room or space, designed into this Project.

UNDETERMINED: BUILDING IS AN EMPTY SHELL AT THIS POINT IN TIME.

(Designers Stamp & Signature)

PSH 6/07/2K

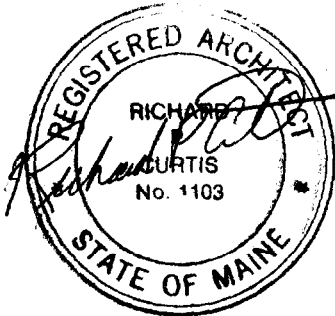

City of Portland INSPECTION SERVICES

Room 315
389 Congress Street
Portland, Maine 04101

Phone: (207) 874-8703 or 874-8693
Fax : (207) 874-8716

FAX TRANSMISSION COVER SHEET

Date: 8/30/01
To: Buse Kiftler
Fax: 772-9078
Re: 3 Doc's Design Pro
Sender: Jeanie Bortke

Forward to
Guy L., CWS
774-4016

YOU SHOULD RECEIVE $\frac{1}{4}$ PAGE(S), INCLUDING THIS COVER SHEET.
IF YOU DO NOT RECEIVE ALL THE PAGES, PLEASE CALL 874-8693 or 874-8703.

RE: 135 N.W.

Guy - FYI - Special Inspections are also req'd - I left message w/ Paul B. to please come up w/ Plan.
BY

Fore River Company

5 Milk Street

P.O. Box 7525

Portland, Maine 04112

(207) 772-6404

TRANSMITTAL NOTICE - BY HAND		DATE: 1/11/00
TO: P. SAMUEL HOFFSES CHIEF OF INSPECTION SERVICES BUILDING INSPECTION CITY OF PORTLAND		SUBJECT: FIVE LIVER COMPANY 135 MARGINAL WAY SITE PLAN REVIEW
NO. OF COPIES: 7 EA (11x17) AND (24x36) 7 " " " 7 " " " 7 " " " 7 " " " 7 EA (11x17) AND (24x36)	DESCRIPTION: DRAWINGS: S-1, SE-1, AND LS-1 DATED 6/30/00 , A1.1 & A 3.1 DATED 5-10-00 WRITTEN STATEMENT DATED 7/1/00 PER §14-525(b)1 RESPONSES DATED 7/1/00 PER §14-525c C.C. LETTER TO CLIFFORD FARRIS, DEPT OF PUBLIC WORKS DRAWING E-LWM DATED 1-10-00	
REMARKS: 2 (24x36) Drawings S-1 (additional Site Plans) DEAR MR HOFFSES, ATTACHED IS OUR APPLICATION FOR MAJOR SITE PLAN REVIEW FOR A PROPOSED RETAIL/OFFICE BUILDING ON MARGINAL WAY. I BELIEVE THE ONLY OUTSTANDING DRAWING IS AN EMBOSSED SURVEY. I WILL DELIVER THIS DRAWING SHORTLY. PLEASE CALL IF YOU HAVE ANY QUESTIONS, PROBLEMS, OR COMMENTS. SINCERELY, BRUCE KISTLER		

**CITY OF PORTLAND, MAINE
DEVELOPMENT REVIEW APPLICATION
PLANNING DEPARTMENT PROCESSING FORM**

20000142

I. D. Number

Five Liver Company

Applicant

P.O. Box 7525, Portland, ME 04112

Applicant's Mailing Address

Fore River Company

Consultant/Agent

7/12/00

Application Date

Marginal Way

Project Name/Description

135 Marginal Way, Portland Maine 04101

Address of Proposed Site

025-B-001

Assessor's Reference: Chart-Block-Lot

Applicant or Agent Daytime Telephone, Fax

Proposed Development (check all that apply):
 Office Retail Manufacturing Warehouse/Distribution Parking Lot Other (specify) _____
 New Building Building Addition Change Of Use Residential

18,000 Proposed Building square Feet or # of Units **1.44 ac** Acreage of Site **B5** Zoning

Check Review Required:

- Site Plan (major/minor)
- Flood Hazard
- Zoning Conditional Use (ZBA/PB)
- Subdivision # of lots _____
- Shoreland
- PAD Review
- Historic Preservation
- 14-403 Streets Review
- DEP Local Certification
- Other _____

Fees Paid: Site Plan **\$500.00**

Date: **7/12/00**

Inspections Approval Status

- Approved
- Approval Date _____
- Condition Compliance

Denied

Additional Sheets Attached



Performance Guarantee

* No building permit may be issued until a performance guarantee is submitted.

<input type="checkbox"/> Performance Guarantee Accepted	_____	_____	_____
	date	amount	expiration date
<input type="checkbox"/> Inspection Fee Paid	_____	_____	
	date	amount	
<input type="checkbox"/> Building Permit Issued	_____		
	date		
<input type="checkbox"/> Performance Guarantee Reduced	_____	_____	_____
	date	remaining balance	signature
<input type="checkbox"/> Temporary Certificate of Occupancy	_____	<input type="checkbox"/> Conditions (See Attached)	
	date		
<input type="checkbox"/> Final Inspection	_____	_____	
	date	signature	
<input type="checkbox"/> Certificate Of Occupancy	_____		
	date		
<input type="checkbox"/> Performance Guarantee Released	_____	_____	
	date	signature	
<input type="checkbox"/> Defect Guarantee Submitted	_____	_____	_____
	submitted date	amount	expiration date

Marginal Way - 135

**CITY OF PORTLAND, MAINE
DEVELOPMENT REVIEW APPLICATION
PLANNING DEPARTMENT PROCESSING FORM
DRC Copy**

2000-0142
Application I. D. Number
07/12/2000
Application Date

Five Liver Company
Applicant

PO Box 7525, Portland, ME 04112
Applicant's Mailing Address

Fore River Company
Consultant/Agent

Agent Ph: _____ Agent Fax: _____
Applicant or Agent Daytime Telephone, Fax

Five Liver Company
Project Name/Description

135 - 135 Marginal Way, Portland Maine 04101
Address of Proposed Site

025 B001001
Assessor's Reference: Chart-Block-Lot

Proposed Development (check all that apply): New Building Building Addition Change Of Use Residential Office Retail
 Manufacturing Warehouse/Distribution Parking Lot Other (specify) _____

18,000 1.44 ac B5
Proposed Building square Feet or # of Units Acreage of Site Zoning

Check Review Required:

- | | | | |
|--|---|--|--|
| <input checked="" type="checkbox"/> Site Plan
(major/minor) | <input type="checkbox"/> Subdivision
of lots _____ | <input type="checkbox"/> PAD Review | <input type="checkbox"/> 14-403 Streets Review |
| <input type="checkbox"/> Flood Hazard | <input type="checkbox"/> Shoreland | <input type="checkbox"/> Historic Preservation | <input type="checkbox"/> DEP Local Certification |
| <input type="checkbox"/> Zoning Conditional
Use (ZBA/PB) | <input type="checkbox"/> Zoning Variance | <input type="checkbox"/> Other _____ | |

Fees Paid: Site Plan \$500.00 Subdivision _____ Engineer Review \$1,943.74 Date 08/24/2001

DRC Approval Status:

Reviewer Steve Bushey

- Approved Approved w/Conditions
See Attached Denied

Approval Date 01/09/2001 Approval Expiration 01/09/2002 Extension to _____ Additional Sheets
Attached

Condition Compliance Rick Knowland 01/09/2001
signature date

Performance Guarantee Required* Not Required

* No building permit may be issued until a performance guarantee has been submitted as indicated below

<input type="checkbox"/> Performance Guarantee Accepted	<u>08/22/2001</u> date	<u>\$97,187.00</u> amount	<u>10/29/2003</u> expiration date
<input type="checkbox"/> Inspection Fee Paid	_____ date	_____ amount	
<input type="checkbox"/> Building Permit Issue	_____ date		
<input type="checkbox"/> Performance Guarantee Reduced	_____ date	_____ remaining balance	_____ signature
<input type="checkbox"/> Temporary Certificate of Occupancy	_____ date	<input type="checkbox"/> Conditions (See Attached)	_____ expiration date
<input type="checkbox"/> Final Inspection	_____ date	_____ signature	
<input type="checkbox"/> Certificate Of Occupancy	_____ date		
<input type="checkbox"/> Performance Guarantee Released	_____ date	_____ signature	
<input type="checkbox"/> Defect Guarantee Submitted	_____ submitted date	_____ amount	_____ expiration date
<input type="checkbox"/> Defect Guarantee Released	_____ date	_____ signature	

**DEVELOPMENT REVIEW APPLICATION
PLANNING DEPARTMENT PROCESSING FORM
Planning Copy**

2000-0142
Application I. D. Number

07/12/2000
Application Date

Five Liver Company
Applicant

PO Box 7525, Portland, ME 04112
Applicant's Mailing Address

Fore River Company
Consultant/Agent

Agent Ph: _____ Agent Fax: _____
Applicant or Agent Daytime Telephone, Fax

Five Liver Company
Project Name/Description

135 - 135 Marginal Way, Portland Maine 04101
Address of Proposed Site

025 B001001
Assessor's Reference: Chart-Block-Lot

Proposed Development (check all that apply): New Building Building Addition Change Of Use Residential Office Retail
 Manufacturing Warehouse/Distribution Parking Lot Other (specify) _____

18,000 1.44 ac B5
Proposed Building square Feet or # of Units Acreage of Site Zoning

Check Review Required:

- | | | | |
|--|---|--|--|
| <input checked="" type="checkbox"/> Site Plan
(major/minor) | <input type="checkbox"/> Subdivision
of lots _____ | <input type="checkbox"/> PAD Review | <input type="checkbox"/> 14-403 Streets Review |
| <input type="checkbox"/> Flood Hazard | <input type="checkbox"/> Shoreland | <input type="checkbox"/> Historic Preservation | <input type="checkbox"/> DEP Local Certification |
| <input type="checkbox"/> Zoning Conditional
Use (ZBA/PB) | <input type="checkbox"/> Zoning Variance | <input type="checkbox"/> Other _____ | |

Fees Paid: Site Plan \$500.00 Subdivision _____ Engineer Review \$1,943.74 Date 08/24/2001

Planning Approval Status:

Reviewer rk

- Approved Approved w/Conditions
See Attached Denied

Approval Date 01/09/2001 Approval Expiration 01/09/2002 Extension to _____ Additional Sheets Attached

OK to Issue Building Permit _____
signature date

Performance Guarantee Required* Not Required

* No building permit may be issued until a performance guarantee has been submitted as indicated below

<input type="checkbox"/> Performance Guarantee Accepted	<u>08/22/2001</u> date	<u>\$97,187.00</u> amount	<u>10/29/2003</u> expiration date
<input type="checkbox"/> Inspection Fee Paid	_____ date	_____ amount	
<input type="checkbox"/> Building Permit Issue	_____ date		
<input type="checkbox"/> Performance Guarantee Reduced	_____ date	_____ remaining balance	_____ signature
<input type="checkbox"/> Temporary Certificate of Occupancy	_____ date	<input type="checkbox"/> Conditions (See Attached)	_____ expiration date
<input type="checkbox"/> Final Inspection	_____ date	_____ signature	
<input type="checkbox"/> Certificate Of Occupancy	_____ date		
<input type="checkbox"/> Performance Guarantee Released	_____ date	_____ signature	
<input type="checkbox"/> Defect Guarantee Submitted	_____ submitted date	_____ amount	_____ expiration date
<input type="checkbox"/> Defect Guarantee Released	_____ date	_____ signature	

**CITY OF PORTLAND, MAINE
DEVELOPMENT REVIEW APPLICATION
PLANNING DEPARTMENT PROCESSING FORM
ADDENDUM**

2000-0142

Application I. D. Number

07/12/2000

Application Date

Five Liver Company

Project Name/Description

Five Liver Company

Applicant

PO Box 7525, Portland, ME 04112

Applicant's Mailing Address

Fore River Company

Consultant/Agent

Agent Ph:

Agent Fax:

Applicant or Agent Daytime Telephone, Fax

135 - 135 Marginal Way, Portland Maine 04101

Address of Proposed Site

025 B001001

Assessor's Reference: Chart-Block-Lot

Approval Conditions of Planning

- 1 1.Details for the sanitary sewer service shall be submitted for staff review and approval.
- 2.Final location and spacing of street trees shall be approved by the City Arborist.
- 3.Proposed Hadco and Guth light fixture is acceptable provided that a revised photometric plan of the site shall be submitted for city staff review and approval.

Approval Conditions of Insp

- 1 This permit is being approved on the basis of plans submitted. Any deviations shall require a separate approval before starting that work.
- 2 Separate permits shall be required for each tenant fit up.
- 3 Separate permits shall be required for any new signage.

**CITY OF PORTLAND, MAINE
DEVELOPMENT REVIEW APPLICATION
PLANNING DEPARTMENT PROCESSING FORM
Insp Copy**

2000-0142
Application I. D. Number

07/12/2000
Application Date

Five Liver Compay
Applicant

P.O. Box 7525, Portland, ME 04112
Applicant's Mailing Address

Fore River Company
Consultant/Agent

Five Liver Company
Project Name/Description

135 - 135 Marginal Way, Portland Maine 04101
Address of Proposed Site
025 B001001

Agent Ph: _____ Agent Fax: _____

Applicant or Agent Daytime Telephone, Fax _____

Assessor's Reference: Chart-Block-Lot _____

Proposed Development (check all that apply): New Building Building Addition Change Of Use Residential Office Retail
 Manufacturing Warehouse/Distribution Parking Lot Other (specify) _____

18,000 Proposed Building square Feet or # of Units 1.44 ac Acreage of Site B5 Zoning

Check Review Required:

- | | | | |
|---|--|--|--|
| <input checked="" type="checkbox"/> Site Plan (major/minor) | <input type="checkbox"/> Subdivision # of lots _____ | <input type="checkbox"/> PAD Review | <input type="checkbox"/> 14-403 Streets Review |
| <input type="checkbox"/> Flood Hazard | <input type="checkbox"/> Shoreland | <input type="checkbox"/> Historic Preservation | <input type="checkbox"/> DEP Local Certification |
| <input type="checkbox"/> Zoning Conditional Use (ZBA/PB) | <input type="checkbox"/> Zoning Variance | <input type="checkbox"/> Other _____ | |

Fees Paid: Site Plan \$500.00 Subdivision _____ Engineer Review _____ Date: 07/12/2000

Insp Approval Status:

Reviewer Marge Schmuckal

- Approved Approved w/Conditions See Attached Denied

Approval Date 07/02/2001 Approval Expiration 07/02/2002 Extension to _____ Additional Sheets Attached

Condition Compliance Marge Schmuckal 07/02/2001
signature date

Performance Guarantee Required* Not Required

* No building permit may be issued until a performance guarantee has been submitted as indicated below

<input type="checkbox"/> Performance Guarantee Accepted	_____	_____	_____
	date	amount	expiration date
<input type="checkbox"/> Inspection Fee Paid	_____	_____	
	date	amount	
<input type="checkbox"/> Building Permit Issued	_____		
	date		
<input type="checkbox"/> Performance Guarantee Reduced	_____	_____	_____
	date	remaining balance	signature
<input type="checkbox"/> Temporary Certificate of Occupancy	_____	<input type="checkbox"/> Conditions (See Attached)	_____
	date		expiration date
<input type="checkbox"/> Final Inspection	_____	_____	
	date	signature	
<input type="checkbox"/> Certificate Of Occupancy	_____		
	date		
<input type="checkbox"/> Performance Guarantee Released	_____	_____	
	date	signature	
<input type="checkbox"/> Defect Guarantee Submitted	_____	_____	_____
	submitted date	amount	expiration date

**CITY OF PORTLAND, MAINE
DEVELOPMENT REVIEW APPLICATION
PLANNING DEPARTMENT PROCESSING FORM
ADDENDUM**

2000-0142

Application I. D. Number

07/12/2000

Application Date

Five Liver Company

Project Name/Description

Five Liver Compay

Applicant

P.O. Box 7525, Portland, ME 04112

Applicant's Mailing Address

Fore River Company

Consultant/Agent

Agent Ph:

Agent Fax:

Applicant or Agent Daytime Telephone, Fax

135 - 135 Marginal Way, Portland Maine 04101

Address of Proposed Site

025 B001001

Assessor's Reference: Chart-Block-Lot

Approval Conditions of Insp

- 1 This permit is being approved on the basis of plans submitted. Any deviations shall require a separate approval before starting that work.
- 2 Separate permits shall be required for each tenant fit up.
- 3 Separate permits shall be required for any new signage.

7/7/00

Site Plan Review

New Retail/Office Building Facility at 135 Marginal Way, Portland, Maine

Below are responses to contents requirements as set forth in Portland's Land Use §14-525b. The numbers below correspond to the numbers given in the code.

§14-525(b)1)

- a. **Applicant:** **Five Liver Company**
 P.O. Box 7525
 Portland, ME 04112

- Development Name:** **135 Marginal Way**
 New Retail/Office Building

- b. **See Site Plan.**

- c. **See Site Plan.**

- d. **See Site Plan.**

- e. **See "Grading Plan".**

§14-525(b)2)

- a. **Existing soils – sand, gravel, bricks, ash, grey silty clay, grey silty sand, and gravel.**

- b. **Site is 100% impervious and without rock outcroppings. No easements or rights of way. Drainage on "Grading Plan".**

- c. **See Site Plan, floor plan, and Elevations.**

- d. **See Site Plan.**

- e. **See Site Plan and grading plan (to follow).**

- f. **None.**

- g. **See Site Plan.**

- h. **See Landscape Plan.**

- i. **See Site Plan.**

- j. **See site lighting plan to follow.**

- k. **See Site Plan.**

- l. **N/A.**

- m. **See written statement.**

- n. **See Grading Plan details.**

- o. **All recycling to be by tenants within tenants' spaces.**

7/7/00

Site Plan Review – Written Statements
New Retail/Office Building Facility at 135 Marginal Way, Portland, Maine

Below are responses to written statement requirements as set forth in Portland's Land Use §14-525c. The numbers below correspond to the numbers given in the code.

14-525c: Owners

Five Liver Company (FLC)
P.O. Box 7525
Portland, ME 04112

- 1) Site to be used for retail sales and office uses.
- 2) Land Area
1.44± acres

Proposed Coverage
Bldg, 18,000± SF
- 3) None.
- 4) Normal retail waste.
- 5) Site is currently served by:
PWD – water & sprinklers
Portland Sewer Department – sewer & storm
(a letter to Public Works verifying sewer capacity is attached)
CMP – electrical
Northern Utilities – natural gas
Bell Atlantic – telephone
- 6) Site waste management:

The site currently is mostly impervious with one building. The surrounding land is mostly developed commercial properties. The land immediately to the east is low-lying with various growths that drain to a field inlet east of the site. Storm water on the center of the site drains to an existing catch basin system and is piped into the Marginal Way drainage system. The front portion of the site currently flows overland to Marginal Way.

The plans call for demolition of the existing building and reconstruction of the existing parking areas and storm drain system. The reconstructed storm drain system will include relocation of catch basins to more advantageous locations, new piping, and the installation of a Casco Trap in the catch basin just before the storm water leaves the site.

The plans also call for a new curb cut for shared access to this site and the adjacent site, 161 Marginal Way. A catch basin will be installed to facilitate better drainage around the new curb cut and shared access area and will be piped to the existing catch basin serving the existing curb cut.

The proposed impervious surface area is consistent with the existing surface and therefore should impose no increased runoff. It is not anticipated that this project will have an increased adverse effect on the downstream receiving area. A letter from Public Works verifying capacity has been requested. An erosion control plan is part of this project with details and instructions on the plans.

- 7) **Permitting – 1 month
Construction – 6 months**
 - **Demolition**
 - **Site work**
 - **New building construction**
- 8) **None.**
- 9) **To follow.**
- 10) **See attached tax bills.**
- 11) **None.**
- 12) **Any plans in this format will follow.**
- 13) **Recycling will be the responsibility of the individual tenants. Storage of recyclables will be within tenants' spaces.**

City of Portland

July 1, 1999 - June 30, 2000

DUE SEPT. 10, 1999	DUE MARCH 10, 2000	AMOUNT PAID	INTEREST DUE	PAY THIS AMOUNT
\$99.01	\$99.01	\$99.01	\$0.00	\$99.01

SECOND BILLING
F15489

LENDING INST: Assessed Property Description

ACCOUNT NUMBER 000003446 F15489 025 - B-022-001

 **25-B-22 MARGINAL WAY 147 5/12 INTEREST 7116 SF**

BRING COMPLETE TAX BILL WHEN PAYING IN PERSON.

Please Make Your Check Payable to: City of Portland

PARTIAL PAYMENTS MAY BE MADE AT ANY TIME.

FIVE LIVER COMPANY
5 MILK ST
PORTLAND, ME 04101

Change of Address
Name:

RETURN THIS TOP PORTION WITH PAYMENT

Credit cards are not accepted for property tax payments.

KEEP THIS PORTION

2000 REAL ESTATE PROPERTY TAX STATEMENT
City of Portland

Fiscal Year 2000
July 1, 1999 - June 30, 2000

Owner of Record as of April 1, 1999



ACCOUNT NUMBER
000003446 F15489
CBL
025 - B-022-001
LENDING INST.

Assessed Property Description
25-B-22 MARGINAL WAY 147 5/12 INTEREST 7116 SF

FIVE LIVER COMPANY
5 MILK ST
PORTLAND, ME 04101

CURRENT BILLING DISTRIBUTION

School	\$105.15
Public Works	\$12.48
Parks & Recreation	\$5.94
Fire	\$14.65
Police	\$16.04
Debt Repayments	\$21.10
General Government	\$8.91
County	\$5.74
Health & Human Services	(\$5.15)
Library	\$6.73
Metro Transit District	\$4.55
Enterprise Funds	(\$1.19)
Regional Waste Systems	\$2.97

CURRENT BILLING INFORMATION

Land Value	\$7,830.00
Building Value	\$0.00
Total Value	\$7,830.00
Exemptions	\$0.00
Homestead	\$0.00
Taxable Value	\$7,830.00
Tax Rate	\$25.29
TOTAL TAX	\$198.02
AMOUNT PAID	\$99.01

Remittance Instructions

To avoid standing in line, it is recommended that taxes be paid by mail. Please make check or money order payable to: **CITY OF PORTLAND**. Credit cards are not accepted for property tax payments.

Use enclosed envelope to mail in your payment.

Please be sure remittance address on back side of RETURN portion of this tax bill is clearly visible through the window in the return envelope.

Use top right margin for change of address and check off box on return envelope.

A Greater Portion of this Lot

City of Portland

July 1, 1999 - June 30, 2000

DUE SEPT. 10, 1999	DUE MARCH 10, 2000	AMOUNT PAID	INTEREST DUE	PAY THIS AMOUNT
\$3,433.50	\$3,433.50	\$3,433.50	\$0.00	\$3,433.50

SECOND BIL
F15488

LENDING INST: Assessed Property Description

ACCOUNT NUMBER 000003438 F15488 025 - B-005-001

 **25-B-5 MARGINAL WAY 131-145 46632 SQ FT**

BRING COMPLETE TAX BILL WHEN PAYING IN PERSON.

Please Make Your Check Payable to: City of Portland

PARTIAL PAYMENTS MAY BE MADE AT ANY TIME.

FIVE LIVER COMPANY
5 MILK ST
PORTLAND, ME 04101

Change of Address
Name:

RETURN THIS TOP PORTION WITH PAYMENT

Credit cards are not accepted for property tax payments.

KEEP THIS PORTION

2000 REAL ESTATE PROPERTY TAX STATEMENT
City of Portland

Fiscal Year 2000
July 1, 1999 - June 30, 2000

Owner of Record as of April 1, 1999



ACCOUNT NUMBER
000003438 F15488
CBL
025 - B-005-001
LENDING INST.

Assessed Property Description
25-B-5 MARGINAL WAY 131-145 46632 SQ FT

FIVE LIVER COMPANY
5 MILK ST
PORTLAND, ME 04101

CURRENT BILLING DISTRIBUTION

School	\$3,646.38
Public Works	\$432.62
Parks & Recreation	\$206.01
Fire	\$508.16
Police	\$556.23
Debt Repayments	\$734.77
General Government	\$309.02
County	\$199.14
Health & Human Services	(\$178.54)
Library	\$233.46
Metro Transit District	\$157.94
Enterprise Funds	(\$41.20)
Regional Waste Systems	\$103.01

CURRENT BILLING INFORMATION

Land Value	\$132,840.00
Building Value	\$138,690.00
Total Value	\$271,530.00
Exemptions	\$0.00
Homestead	\$0.00
Taxable Value	\$271,530.00
Tax Rate	\$25.29
TOTAL TAX	\$6,867.00
AMOUNT PAID	\$3,433.50

Remittance Instructions

To avoid standing in line, it is recommended that taxes be paid by mail. Please make check or money order payable to: **CITY OF PORTLAND**. Credit cards are not accepted for property tax payments.

Use enclosed envelope to mail in your payment.

Please be sure remittance address on back side of RETURN portion of this tax bill is clearly visible through the window in the return envelope.

Use top right margin for change of address and check off box on return envelope.

A Portion of this Lot

City of Portland

July 1, 1999 - June 30, 2000

DUE SEPT. 10, 1999 \$6,584.76	DUE MARCH 10, 2000 \$6,584.76	AMOUNT PAID \$6,584.76	INTEREST DUE \$0.00	PAY THIS AMOUNT \$6,584.76
----------------------------------	----------------------------------	---------------------------	------------------------	-------------------------------

SECOND BILLING
S38420

LENDING INST: Assessed Property Description
 ACCOUNT NUMBER 000003430 S38420 025 - B-001-001 25-B-1
 MARGINAL WAY 149-171
 52355 SQ FT



SOUTHERN MAINE PROPERTIES
 COMPANY
 5 MILK ST P O BOX 7525
 PORTLAND, ME 04112

BRING COMPLETE TAX BILL WHEN
 PAYING IN PERSON.

Please Make Your Check Payable to:
 City of Portland

PARTIAL PAYMENTS MAY BE MADE
 AT ANY TIME.

RETURN THIS TOP PORTION WITH PAYMENT

Credit cards are not accepted for property tax payments.

KEEP THIS PORTION

2000 REAL ESTATE PROPERTY TAX STATEMENT
 City of Portland

Fiscal Year 2000
 July 1, 1999 - June 30, 2000

Owner of Record as of April 1, 1999



SOUTHERN MAINE PROPERTIES
 COMPANY
 BOX 7525 DTS, 5 MILK ST
 PORTLAND, ME 04112

Assessed Property Description
 25-B-1
 MARGINAL WAY 149-171
 52355 SQ FT

ACCOUNT NUMBER
 000003430 S38420
 CBL
 025 - B-001-001
 LENDING INST.

CURRENT BILLING DISTRIBUTION

School	\$6,993.02
Public Works	\$829.68
Parks & Recreation	\$395.09
Fire	\$974.54
Police	\$1,066.73
Debt Repayments	\$1,409.14
General Government	\$592.63
County	\$381.92
Health & Human Services	(\$342.41)
Library	\$447.76
Metro Transit District	\$302.90
Enterprise Funds	(\$79.02)
Regional Waste Systems	\$197.54

CURRENT BILLING INFORMATION

Land Value	\$146,520.00
Building Value	\$374,220.00
Total Value	\$520,740.00
Exemptions	\$0.00
Homestead	\$0.00
Taxable Value	\$520,740.00
Tax Rate	\$25.29
TOTAL TAX	\$13,169.52
AMOUNT PAID	\$6,584.76

Remittance Instructions

To avoid standing in line, it is recommended that taxes be paid by mail. Please make check or money order payable to: **CITY OF PORTLAND**. Credit cards are not accepted for property tax payments.

Use enclosed envelope to mail in your payment.

Please be sure remittance address on back side of RETURN portion of this tax bill is clearly visible through the window in the return envelope.

Use top right margin for change of address and check off box on return envelope.

A PORTION OF THIS LOT

City of Portland

July 1, 1999 - June 30, 2000

DUE SEPT. 10, 1999 \$160.47	DUE MARCH 10, 2000 \$160.47	AMOUNT PAID \$160.47	INTEREST DUE \$0.00	PAY THIS AMOUNT \$160.47
--------------------------------	--------------------------------	-------------------------	------------------------	-----------------------------

SECOND BILLING
S38425

LENDING INST: Assessed Property Description
 ACCOUNT NUMBER 000003440 S38425 025 - B-006-001 25-B-6
 R MARGINAL WAY 137
 2676SF



SOUTHERN MAINE PROPERTIES
 COMPANY
 5 MILK ST P O BOX 7525
 PORTLAND, ME 04112

BRING COMPLETE TAX BILL WHEN
 PAYING IN PERSON.

Please Make Your Check Payable to:
 City of Portland

PARTIAL PAYMENTS MAY BE MADE
 AT ANY TIME.

RETURN THIS TOP PORTION WITH PAYMENT

Credit cards are not accepted for property tax payments.

KEEP THIS PORTION

2000 REAL ESTATE PROPERTY TAX STATEMENT
 City of Portland

Fiscal Year 2000
 July 1, 1999 - June 30, 2000

Owner of Record as of April 1, 1999



SOUTHERN MAINE PROPERTIES
 COMPANY
 BOX 7525 DTS, 5 MILK ST
 PORTLAND, ME 04101

Assessed Property Description
 25-B-6
 R MARGINAL WAY 137
 2676SF

ACCOUNT NUMBER
 000003440 S38425
 CBL
 025 - B-006-001
 LENDING INST.

CURRENT BILLING DISTRIBUTION

School	\$170.42
Public Works	\$20.22
Parks & Recreation	\$9.63
Fire	\$23.75
Police	\$26.00
Debt Repayments	\$34.34
General Government	\$14.44
County	\$9.31
Health & Human Services	(\$8.34)
Library	\$10.91
Metro Transit District	\$7.38
Enterprise Funds	(\$1.99)
Regional Waste Systems	\$4.81

CURRENT BILLING INFORMATION

Land Value	\$8,820.00
Building Value	\$3,870.00
Total Value	\$12,690.00
Exemptions	\$0.00
Homestead	\$0.00
Taxable Value	\$12,690.00
Tax Rate	\$25.29
TOTAL TAX	\$320.94
AMOUNT PAID	\$160.47

Remittance Instructions

To avoid standing in line, it is recommended that taxes be paid by mail. Please make check or money order payable to: **CITY OF PORTLAND**. Credit cards are not accepted for property tax payments.

Use enclosed envelope to mail in your payment.

Please be sure remittance address on back side of RETURN portion of this tax bill is clearly visible through the window in the return envelope.

Use top right margin for change of address and check off box on return envelope.

A PORTION OF THIS LOT

Fore River Company

5 Milk Street

P.O. Box 7525

Portland, ME 04112

(207) 772-6404

July 7, 2000

Clifford Farris, Sewage Facility Tech.
Department of Public Works
City of Portland
55 Portland Street
Portland, ME 04101

re: 135 Marginal Way Storm and Sanitary Sewer Capacity

Dear Mr. Farris,

We are applying for Site Plan Review from the City of Portland for our site at 135 Marginal Way. One of the requirements for Site Plan approval is a letter from Public Works verifying storm and sanitary sewer capacity. Public Works told me you are responsible for these letters.

Briefly, our plans call for the demolition of the existing building, currently Mail Boxes Etc, and the construction of a new 90' x 180' building, reconstruction of the parking lot and storm sewer system, and a new sanitary sewer connection.

The plans for the site call for reconstruction of the existing storm water system by relocating catch basins to more advantageous locations, new piping and the addition of a Casco Trap to the last catch basin just before the storm water is piped off the site.

Because the proposed impervious surface plan is consistent with the existing surface it is not anticipated that this project will have any increased effect on the Marginal Way drainage for the downstream receiving area.

The sanitary sewer plans call for capping the existing 4" C1 service to the existing building and installation of a new 6" line to service the new building. The building is proposed to be for typical retail/office users.

Please review the attached plans and call me with any questions or problems.

Sincerely,

Bruce Kistler

enclosure

Fore River Company

5 Milk Street

P.O. Box 7525

Portland, Maine 04112

(207) 772-6404

TRANSMITTAL NOTICE - By Hand		DATE: 7/12/00
TO: P. SAMUEL HOFFSEY CHIEF OF INSPECTION SERVICES BUILDING INSPECTION CITY OF PORTLAND		SUBJECT: FIVE LEVEL COMPANY 135 MARGINAL WAY MAJOR SITE PLAN REVIEW
NO. OF COPIES: 9 (24x36) 9 (11x17) 7	DESCRIPTION: SITE PLAN w/ SURVEYOR STAMP 7/12/00 COPY OF ABOVE SITE LIGHTING FIXTURE DATA CUTS	
REMARKS: DEAR MR. HOFFSEY, I believe the ATTACHED ALONG WITH OUR SUBMITTAL YESTERDAY completes the APPLICATION for Major Site Plan Review AS CALLED FOR UNDER the ZONING Code. I would appreciate it IF you would REVIEW this application And give me a formal OR informal confirmation that this application is or is NOT complete. Also do you know when this project will be scheduled for Planning Board Review. Sincerely, BRUCE KISTLER		

TYPE: A

CATALOG #: GMX40129AR

McGRAW-EDISON®

DESCRIPTION

McGraw-Edison's Galleria combines beauty and versatility to make it an excellent choice for architects, specifiers and contractors in today's energy- and design-conscious environment. An aesthetic reveal in the formed aluminum housing gives the Galleria a distinctive look while a variety of mounting options and lamp wattages provide maximum flexibility.

APPLICATION

The Galleria achieves superior light distribution by utilizing a seamless reflector system, making it the optimum choice for almost any small or medium area lighting application.

SPECIFICATION FEATURES

A...Housing

Formed aluminum housing with stamped reveal has interior-welded seams for structural integrity and is finished in polyester powder coat. U.L. listed for wet locations. CSA approved.

B...Ballast Tray

Ballast tray is hard-mounted to housing interior for cooler operation.

C...Ballast

Long-life core and coil ballast.

D...Reflector

Spun and stamped aluminum reflector in vertical lamp units, or hydroformed anodized aluminum reflector in horizontal lamp units.

E...Door

Formed aluminum door has heavy-duty hinges, captive retaining screws and is finished in polyester powder coat. (Spider mount unit has steel door.)

F...Lens

Convex tempered glass lens.

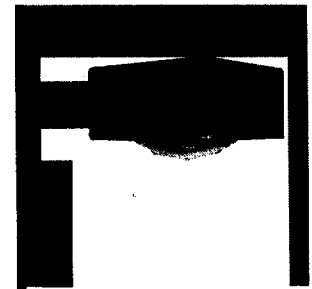
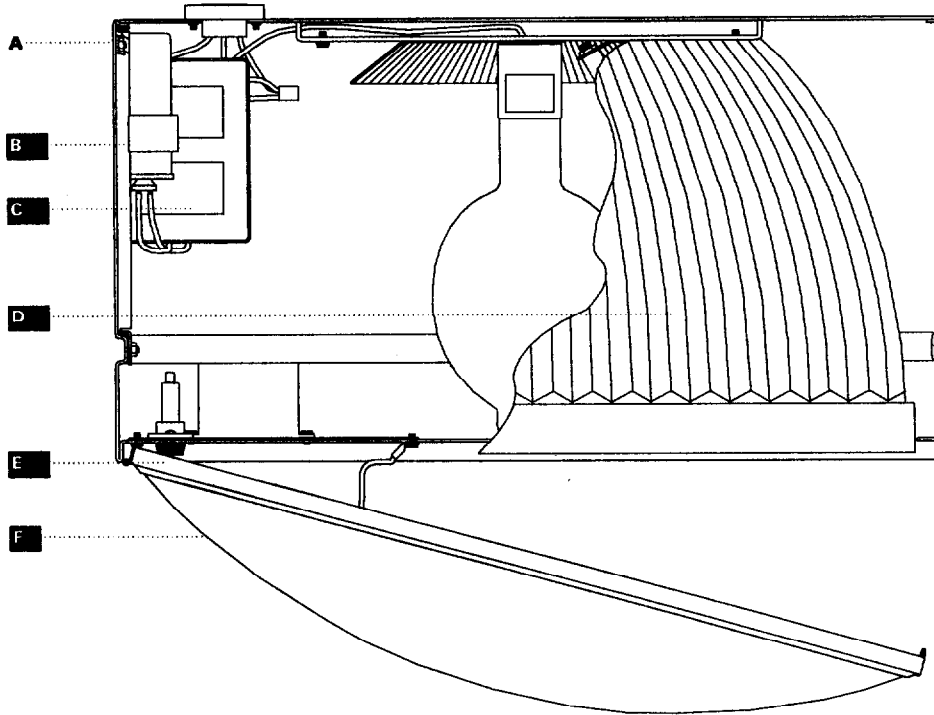

GMGALLERIA
250-400W

Metal Halide

ARCHITECTURAL
AREA LIGHT

*Mounted on
20' poles*

DIMENSIONS

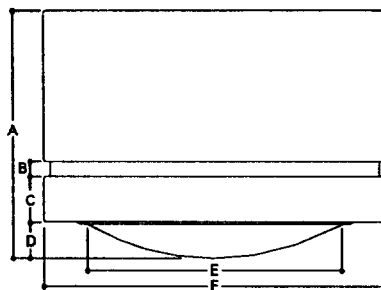

Fixture	A	B	C	D	E	F	G	H	J
Medium (in.)	15	3/4	3	4	18 3/4	21 3/4	6 or 14	12	21
(mm)	381	19	76	102	476	552	152 or 356	305	533

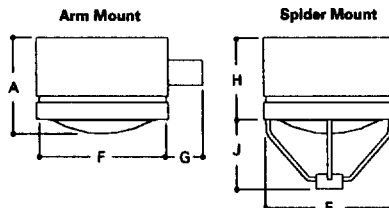

ENERGY DATA

CWA Ballast Input Watts
250W MH HPF (295 Watts)
400W MH HPF (465 Watts)

PHOTOMETRICS

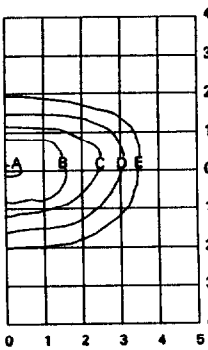

GM-5
GMA401291D
400-Watt MH Type I
40,000-Lumen Clear Lamp

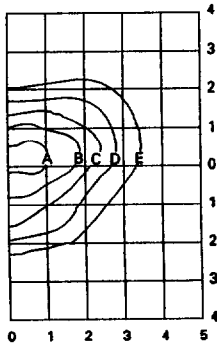

GM-6
GMA401292D
400-Watt MH Type II
40,000-Lumen Clear Lamp

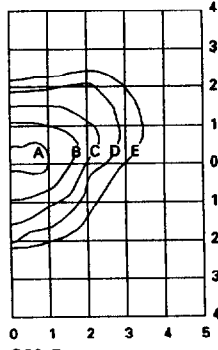

GM-7
GMA401293D
400-Watt MH Type III
40,000-Lumen Clear Lamp

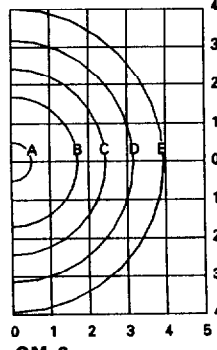

GM-8
GMA40129AR
400-Watt MH Area Round
40,000-Lumen Clear Lamp

Footcandle Table

Select mounting height and read across for footcandle values of each isofootcandle line.

Mounting Height	Footcandle Values for Isofootcandle Lines				
	A	B	C	D	E
20'	11.25	4.50	2.25	1.12	0.56
25'	7.20	2.88	1.44	0.72	0.36
30'	5.00	2.00	1.00	0.50	0.25
35'	3.57	1.43	0.71	0.36	0.18
40'	2.50	1.00	0.50	0.25	0.13

Footcandle Table

Select mounting height and read across for footcandle values of each isofootcandle line.

Mounting Height	Footcandle Values for Isofootcandle Lines				
	A	B	C	D	E
20'	4.50	2.25	1.13	0.56	0.23
25'	2.83	1.41	0.72	0.36	0.14
30'	2.00	1.00	0.50	0.25	0.10
35'	1.47	0.73	0.37	0.18	0.07
40'	1.12	0.56	0.28	0.14	0.06

MOUNTING VARIATIONS

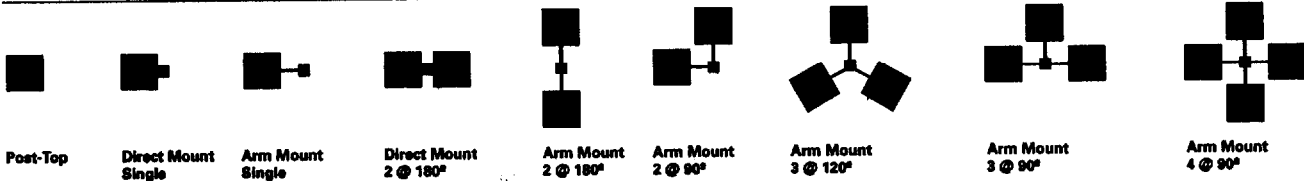

ORDERING INFORMATION

SAMPLE NUMBER: GMA251292D

G M A 40 1 2 9 FT

Product Family
G-Galleria

Housing Size
M-Medium

Mounting Method
A-Arm
B-Spider
C-Spider for 3 1/2" O.D. tenon

Lamp Wattage
25-250
40-400

Lamp Type
1-MH

Ballast Type
2-CWA

Voltage
1-120V
2-208V
3-240V
4-277V
5-480V
6-Triple-Tap wired 347V

Distribution
1D-Type I MCO
2D-Type II MCO
3D-Type III MCO
FT-Forward Throw
AR-Area Round
AS-Area Square
RW-Rectangular Wide

Options (add as suffix)
F-Single Fuse
FF-Double Fused
R-Photocontrol Receptacle
Q-Quartz Restrike
HS-House Side Shield (AR and AS distributions only)
VS-Vandal Shield

Accessories (order separately)
MA1004-14" arm for square pole. 1.0 EPA
MA1005-6" arm for square pole. 0.5 EPA
MA1006-Direct mount kit for square pole
MA1007-14" arm for round pole. 1.0 EPA
MA1008-6" arm for round pole. 0.5 EPA
MA1009-Direct mount kit for round pole
OA1016-Photocontrol-Multi-Tap
OA1027-Photocontrol-480V
MA1010-Single-arm tenon adapter for 3" tenon
MA1011-2 @ 90° tenon adapter for 3" tenon
MA1012-3 @ 120° tenon adapter for 3" tenon
MA1013-4 @ 90° tenon adapter for 3" tenon
MA1014-2 @ 90° tenon adapter for 3" tenon
MA1015-2 @ 120° tenon adapter for 3" tenon
MA1016-3 @ 90° tenon adapter for 3" tenon
MA1017-Single-arm tenon adapter for 2" tenon
MA1018-2 @ 180° tenon adapter for 2" tenon
MA1028-Wall bracket

Catalog Number*	Lamp Wattage	Lamp Type*	Ballast Type/ Power Factor	Voltage ¹	Size	Net Wt. (Lbs.)	Shipping Volume (Cu.Ft.)
Arm Mount (Order arm separately)							
GMA25129XX	250	MH	CWA/HPF	MT	Medium	64	5.5
GMA40129XX	400	MH	CWA/HPF	MT	Medium	64	5.5
Spider Mount (For 2 3/8" O.D. tenon)							
GMB25129XX	250	MH	CWA/HPF	MT	Medium	57	9.1
GMB40129XX	400	MH	CWA/HPF	MT	Medium	57	9.1
Spider Mount (For 3 1/2" O.D. tenon)							
GMC25129XX	250	MH	CWA/HPF	MT	Medium	59	9.1
GMC40129XX	400	MH	CWA/HPF	MT	Medium	59	9.1

NOTES: ¹ Arm not included. See accessories.
² Designate distribution by changing 9th and 10th digits.
³ All lamps are mogul base. Lamps are not included.
⁴ Multi-Tap ballast is 120/208/240/277V. Triple-Tap ballast is 120/277/347V.

Colors (add as suffix)
AP=Gray
—=Bronze (standard)
BG=Beige
BK=Black
BL=Blue
GR=Green
RD=Red
SY=Silver
WH=White
YL=Yellow

NOTE: Specifications and Dimensions subject to change without notice.

