

5 SILT FENCE DETAIL NOT TO SCALE

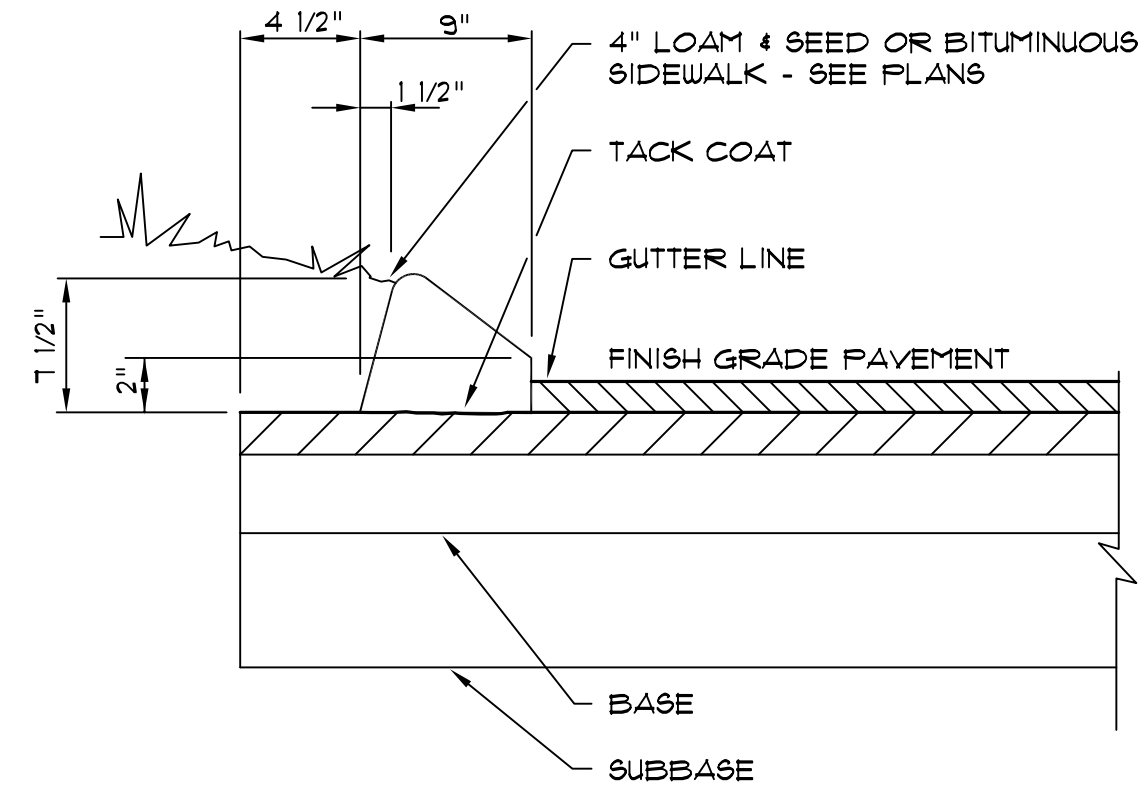

4 SLOPED BITUMINOUS CURB DETAIL NOT TO SCALE

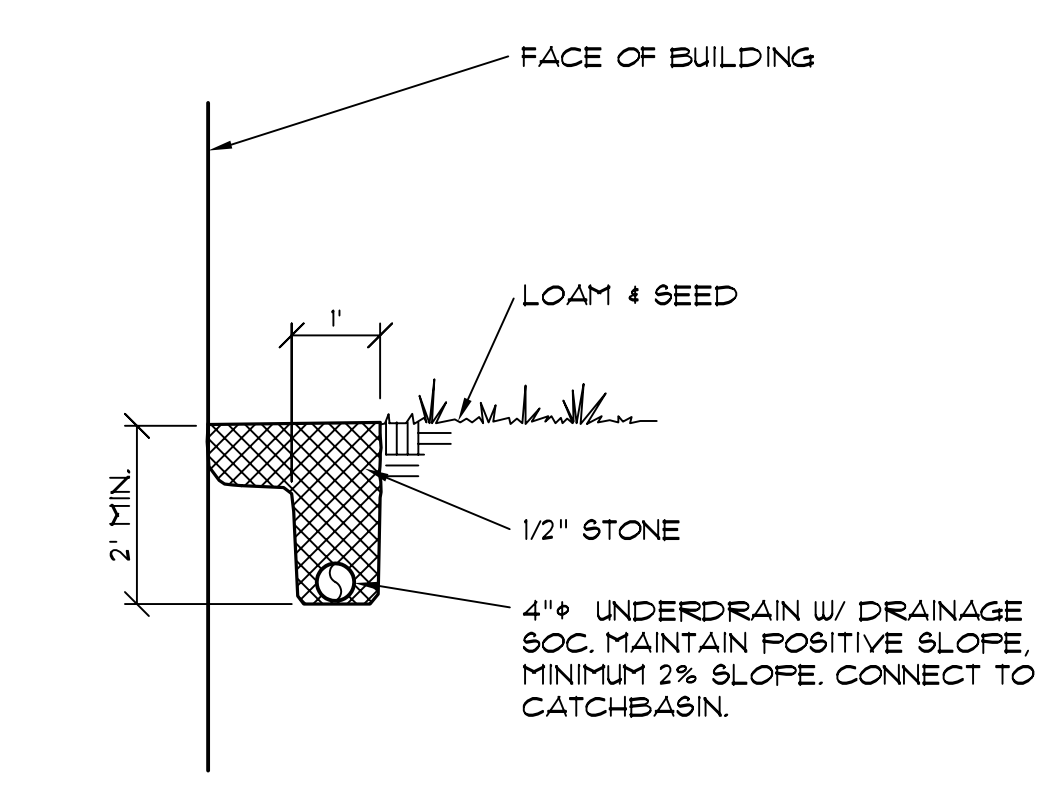

3 STONE DRIPSTRIP SECTION NOT TO SCALE

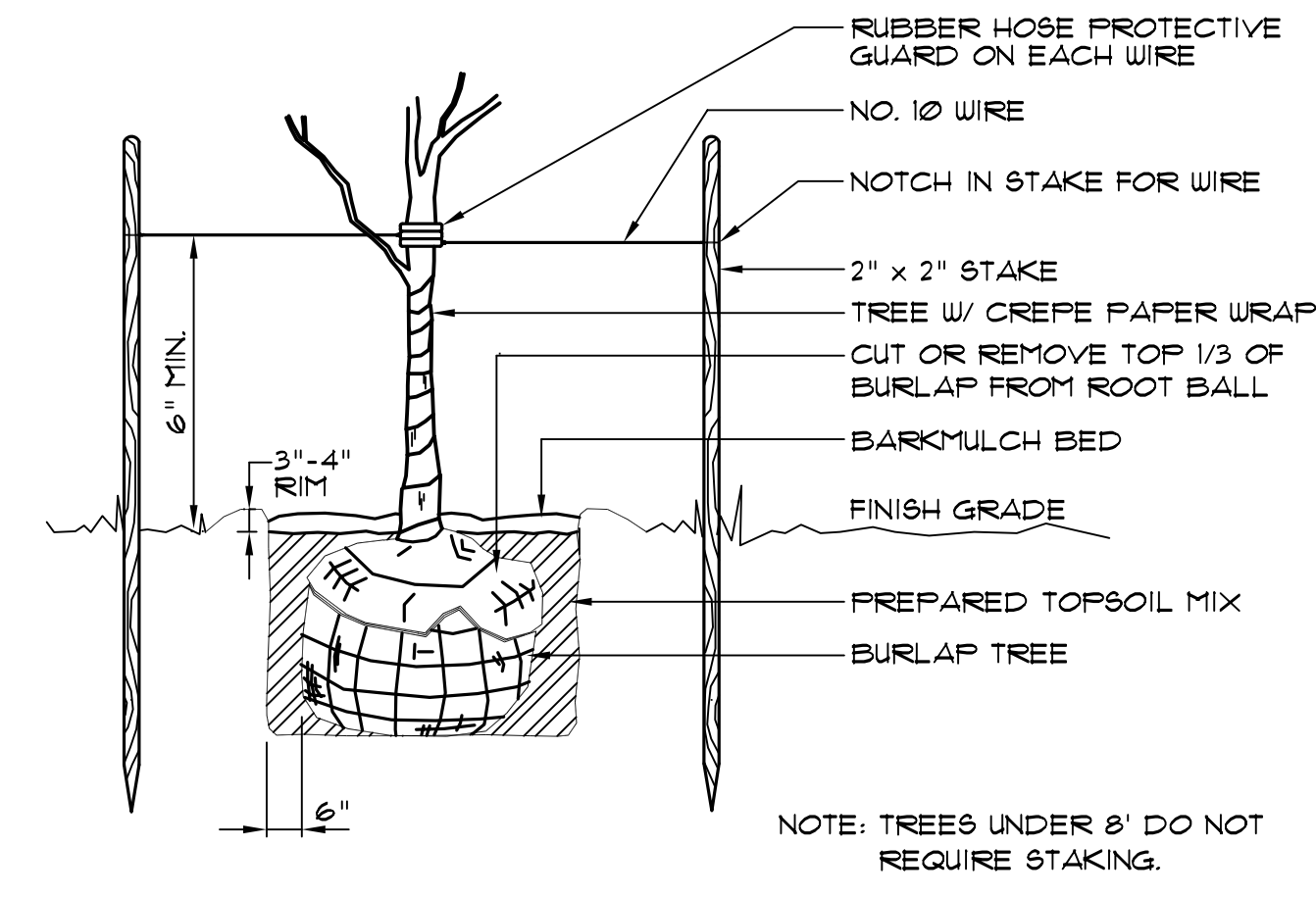

2 TREE PLANTING DETAIL NOT TO SCALE

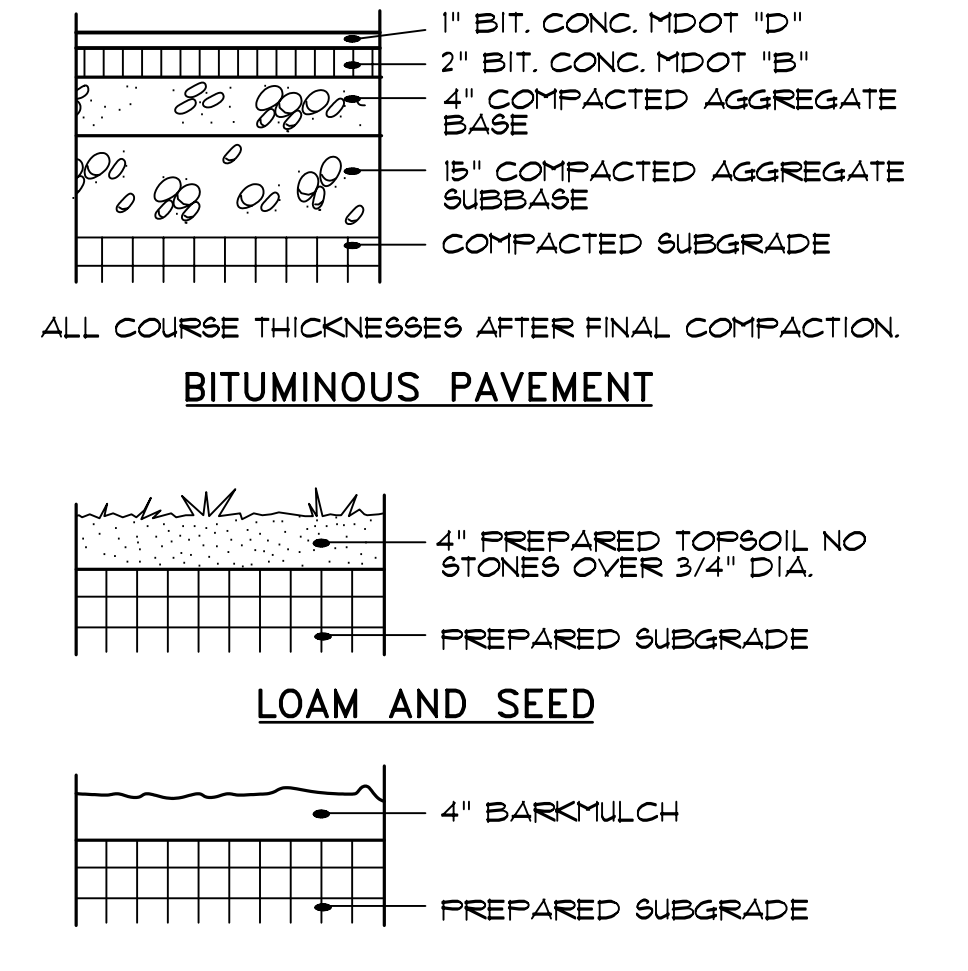

1 SURFACING DETAILS NOT TO SCALE

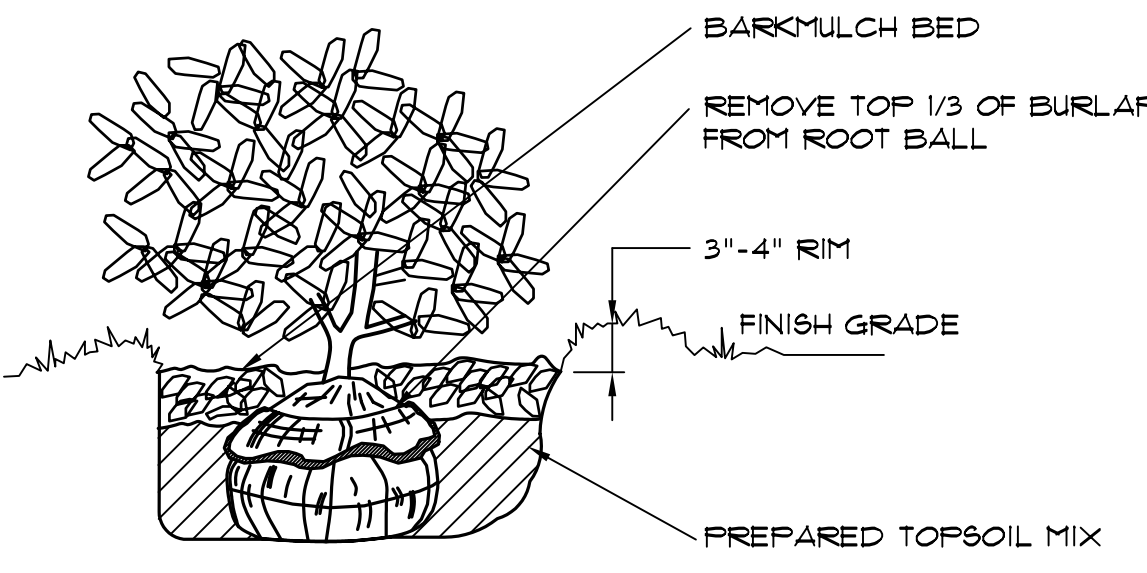

10 SHRUB PLANTING DETAIL NOT TO SCALE

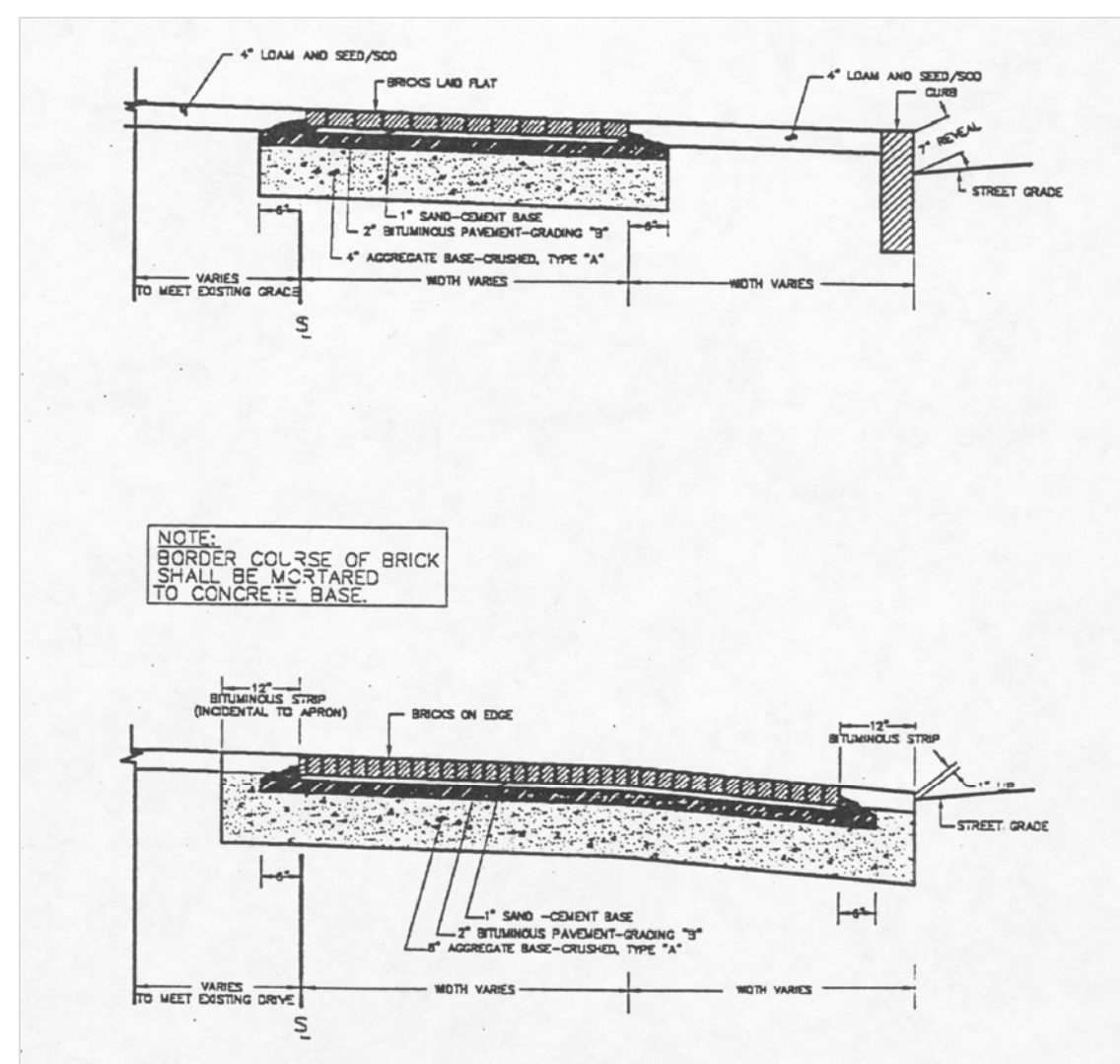

9 BRICK WITH BITUMINOUS BASE SIDEWALK AND DRIVEWAY CONSTRUCTION NOT TO SCALE

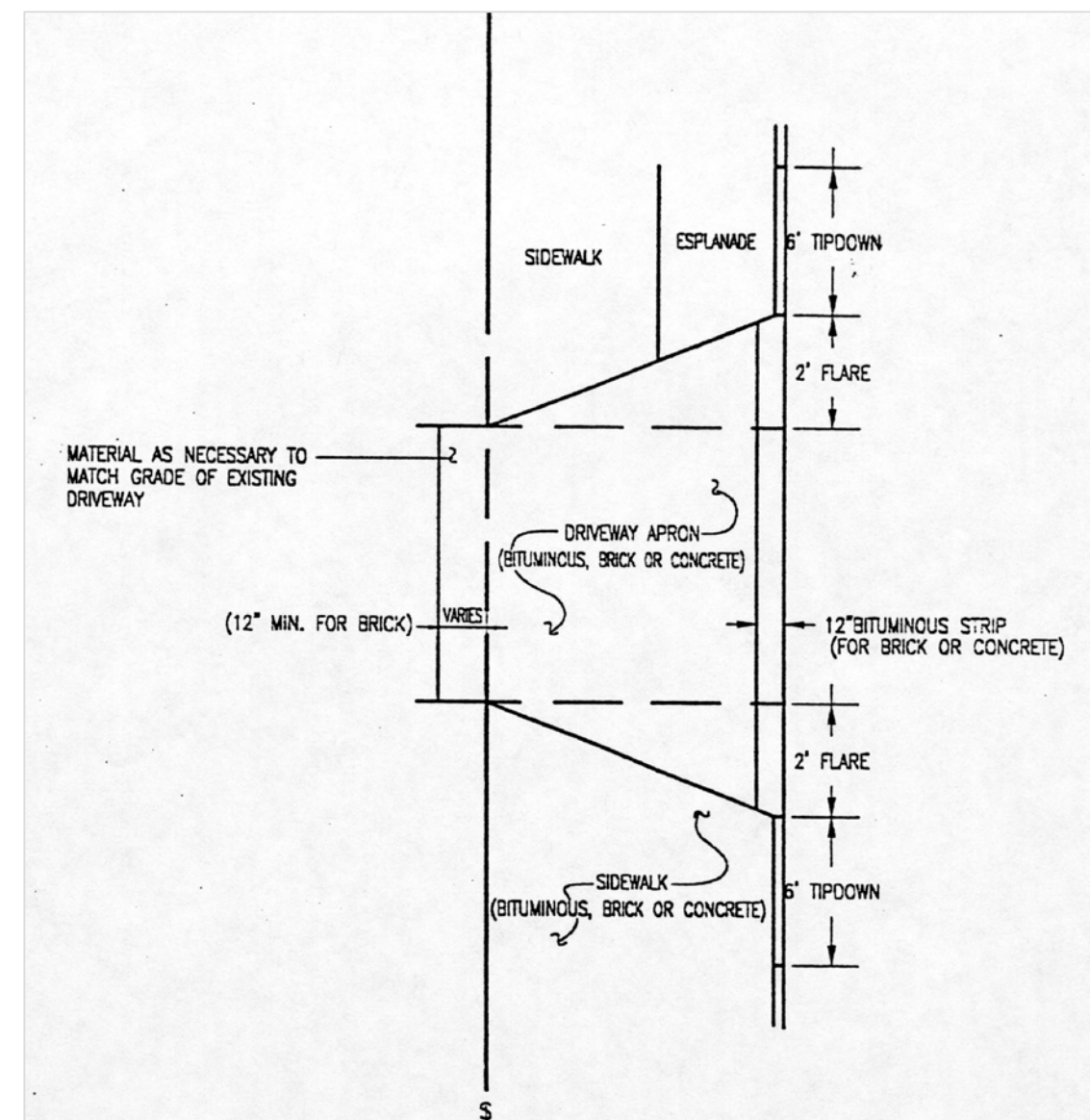

8 SIDEWALK & DRIVEWAY CONSTRUCTION NOT TO SCALE

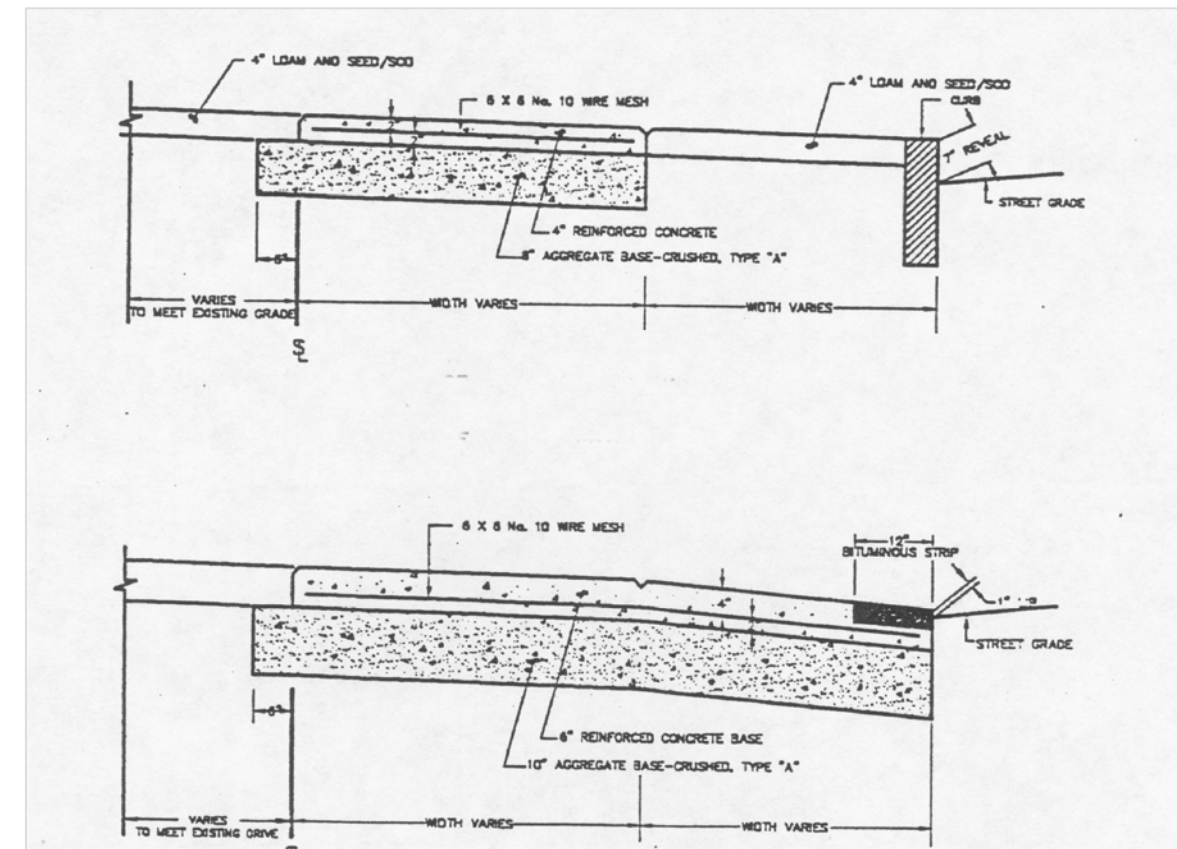

7 CONCRETE SIDEWALK AND DRIVEWAY CONSTRUCTION NOT TO SCALE

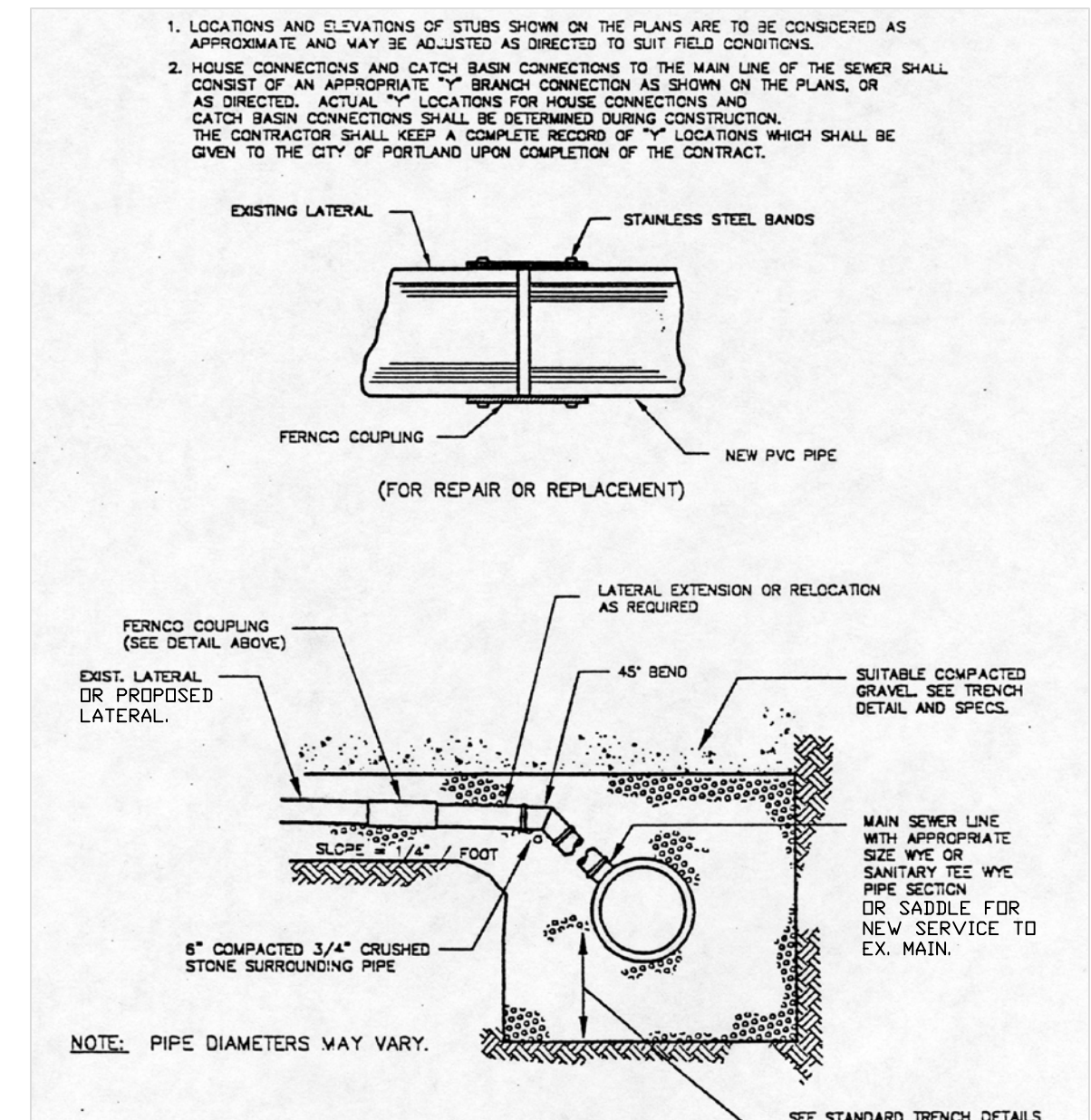

6 TYP. EXISTING LATERAL CONNECTION NOT TO SCALE

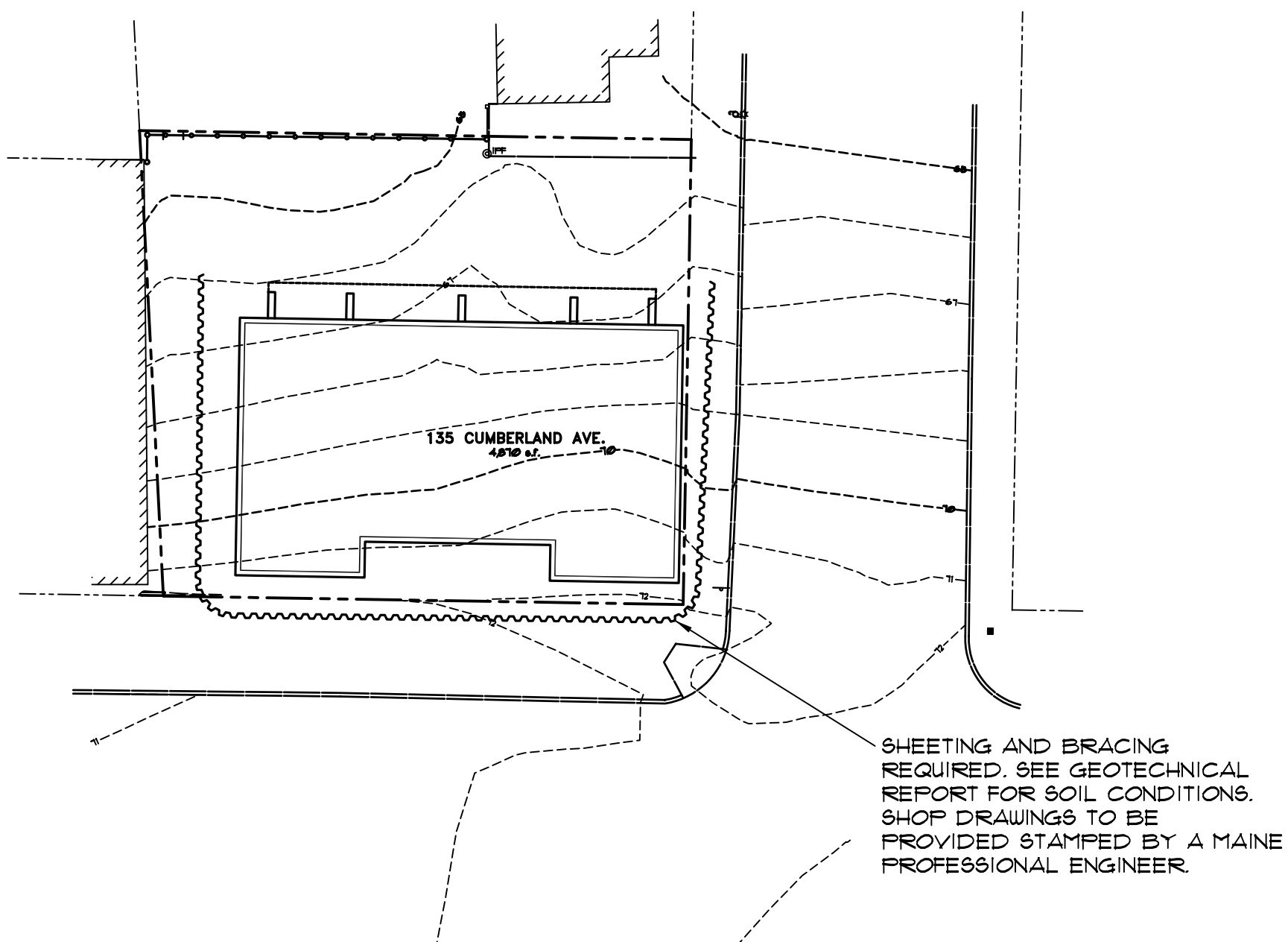

12 SHORING PLAN SCALE: 1"=20'

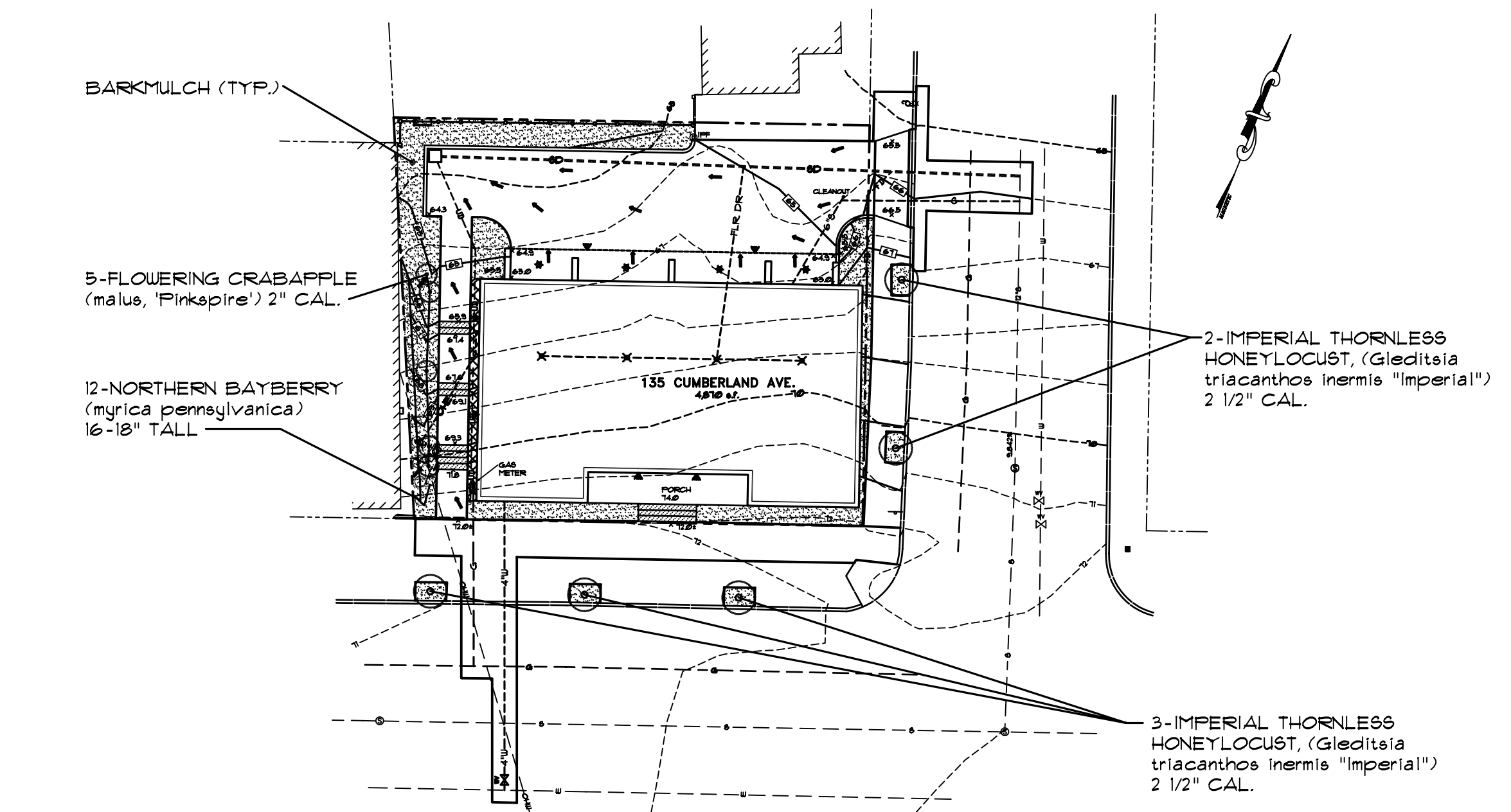

11 LANDSCAPE PLAN SCALE: 1"=20'

CAD FILE: 01417 FILE SCALE: 1"=10' PLOT DATE: 7/25/02

3	1/14/05	ADDED SHORING PLAN
2	7/19/04	REV'D BUILDING FOOTPRINT
1	7/26/02	REV'D PER CITY REVIEW
REV.	DATE	DESCRIPTION

PINKHAM & GREER
 CONSULTING ENGINEERS, INC.
 FALMOUTH, MAINE

PENINSULA COMMUNITY LP II
 510 CUMBERLAND AVE., PORTLAND ME
CUMBERLAND STREET
 PORTLAND, MAINE
DETAILS

SCALE: AS SHOWN DRN BY: NRA/JDC
 DATE: JUNE 18, 2002 DESG BY: TSG
 PROJECT: 02163 CHK BY: TSG

C2