

IF THIS SHEET IS NOT 24 X 36 IT IS A REDUCED SCALE PRINT - SCALE ACCORDINGLY

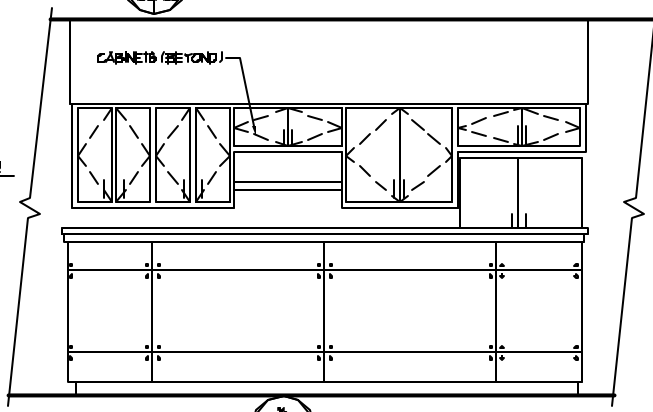
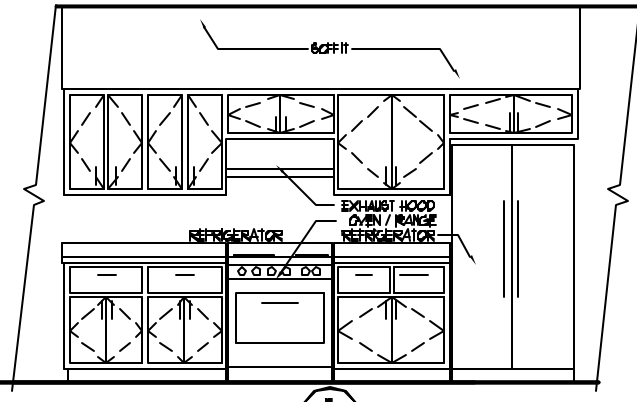
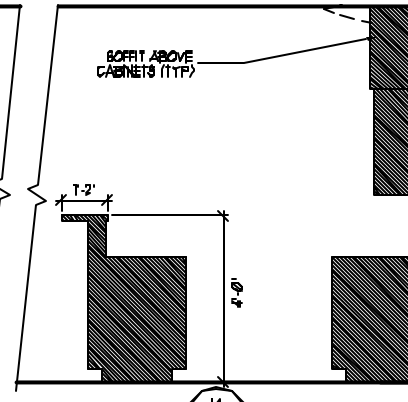
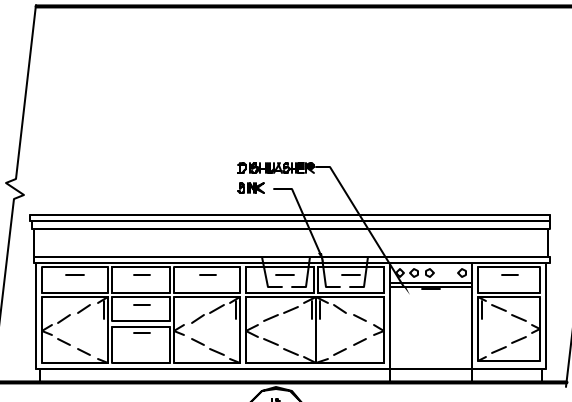
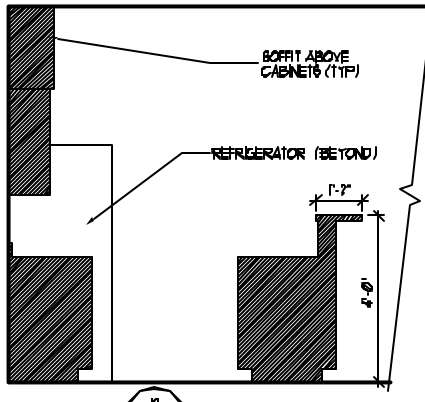
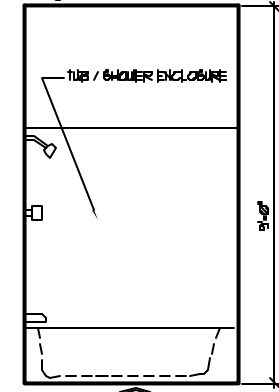
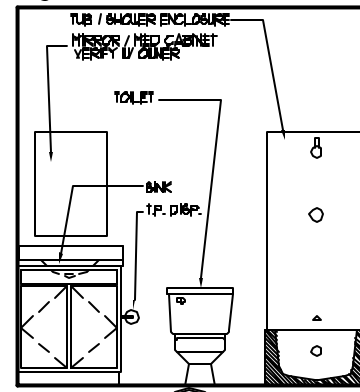
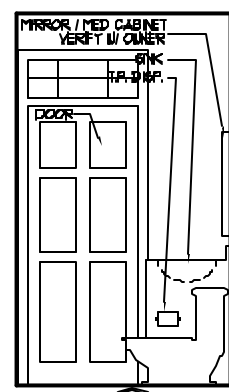
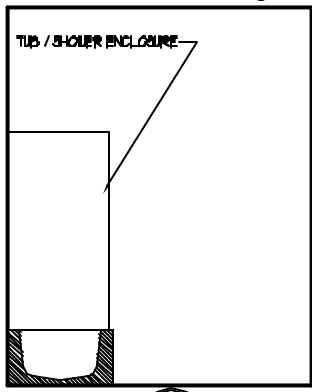
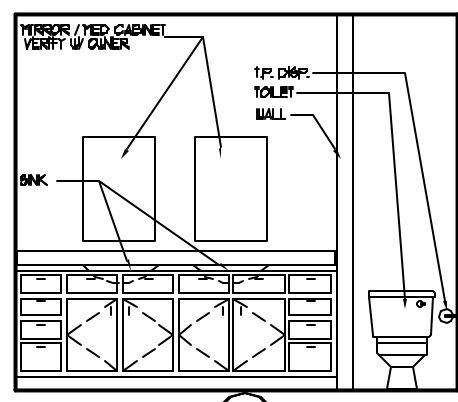
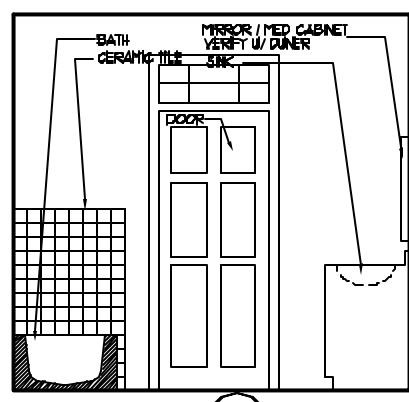
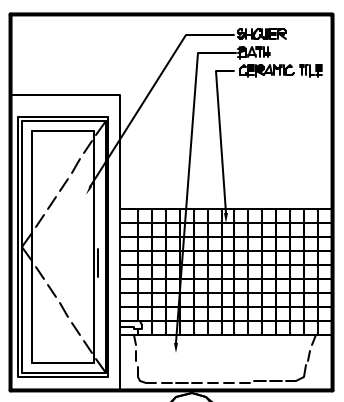
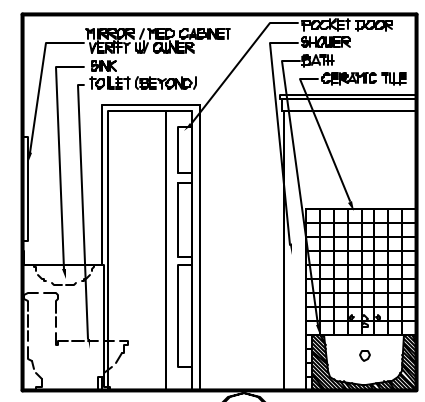
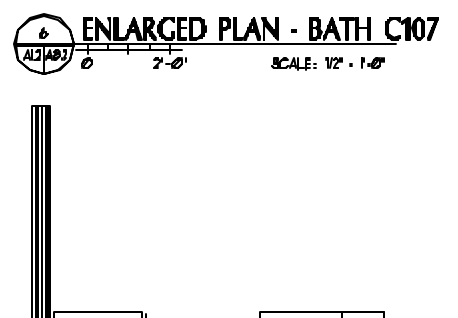
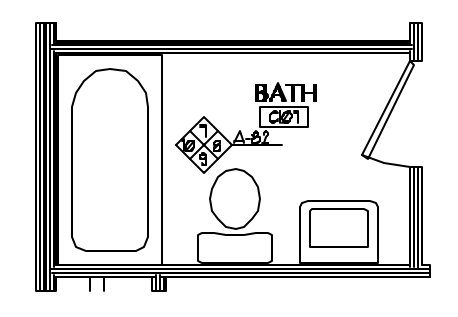
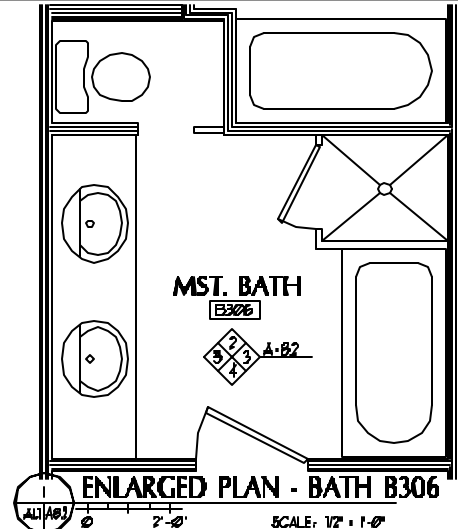

NOTE: REFER TO FLOOR PLANS FOR EXACT DIMENSIONS OF ALL ROOMS.

NOTE: CONTRACTOR TO FIELD VERIFY ALL DIMENSIONS AND VERIFY DIMENSIONS WITH APPLIANCES.

**PORT CITY ARCHITECTURE**  
 85 NEWBURY STREET  
 PORTLAND, ME 04101  
 207.781.9000  
 fax 207.781.2010  
 info@portcityarch.com

CONSULTANTS:

**44 FEDERAL STREET CONDOMINIUMS**  
 44 FEDERAL STREET  
 Portland, Maine 04101

DATE	DESCRIPTION
3-15-25	CONSTRUCTION SET
1-11-25	PERMIT SET
6-9-25	REVIEW SET

PROJECT NAME  
**INTERIOR ELEV. UNITS B & C**

Drawn By: MC  
 Checked By: ACH

**A8.2**

**CONSTRUCTION SET - FOR CONSTRUCTION**

COPYRIGHT: Reuse or reproduction of the contents of this document is not permitted without written permission of PORT CITY ARCHITECTURE P.A.