

IF THIS SHEET IS NOT 24 X 36 IT IS A REDUCED SCALE PRINT - SCALE ACCORDINGLY

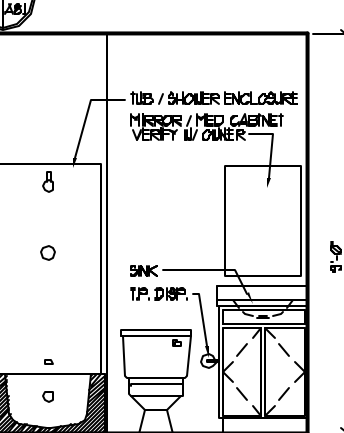
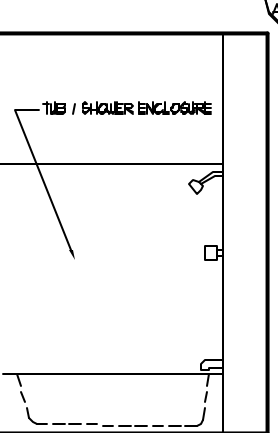
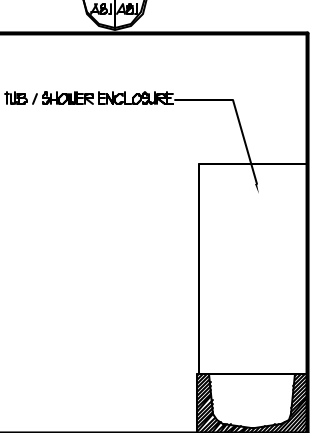
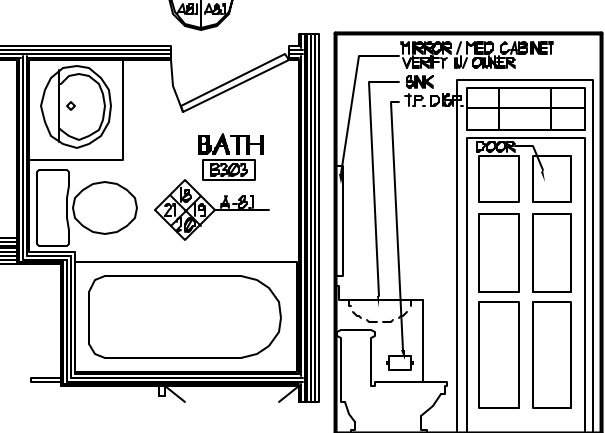
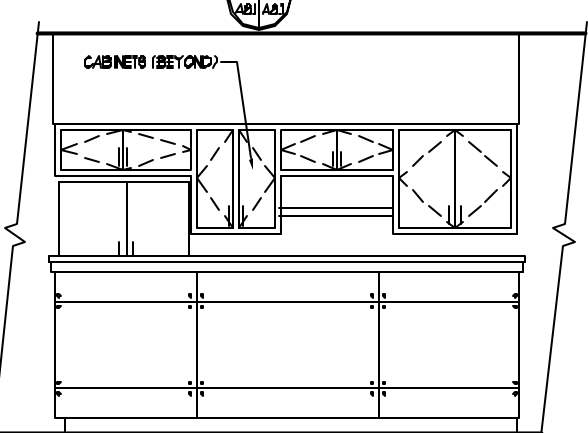
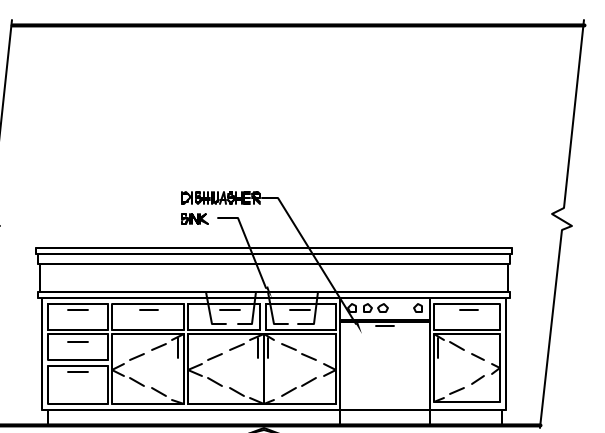
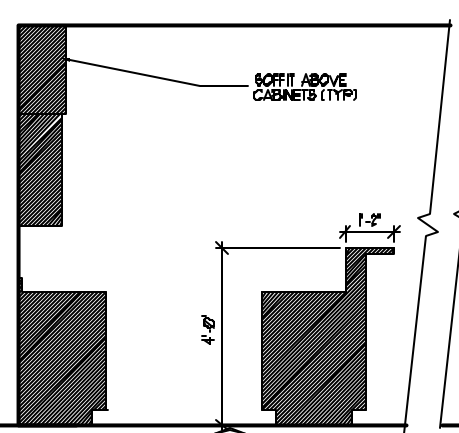
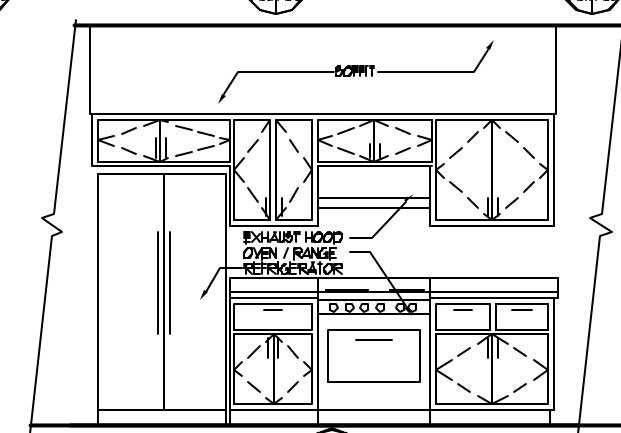
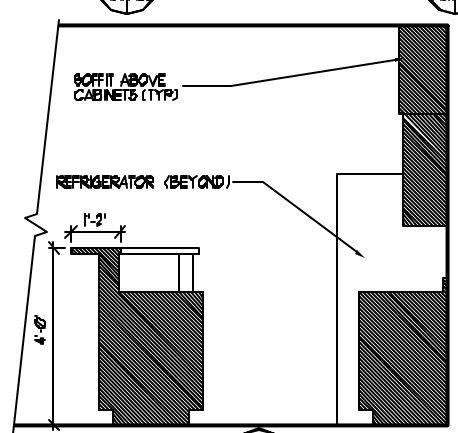
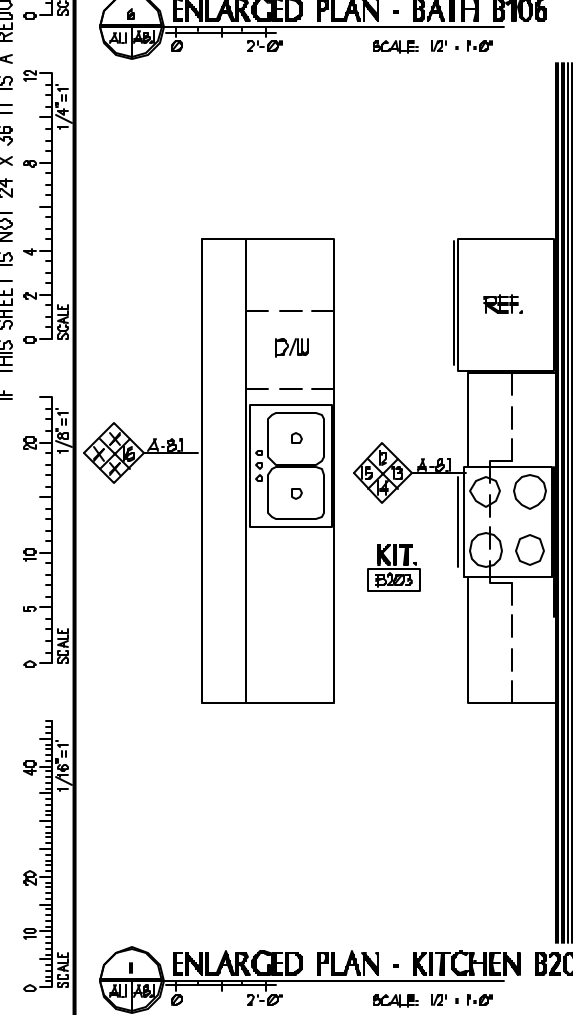
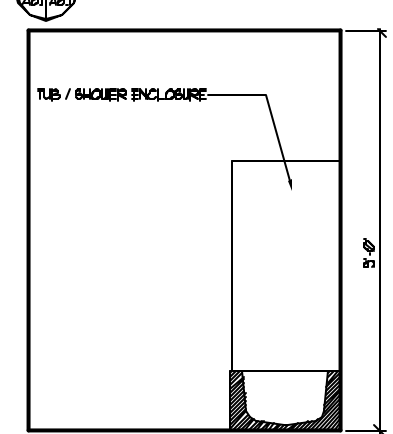
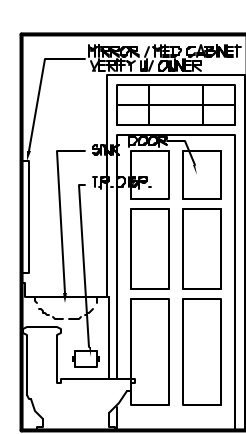
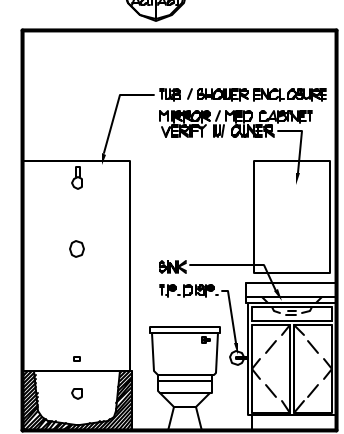
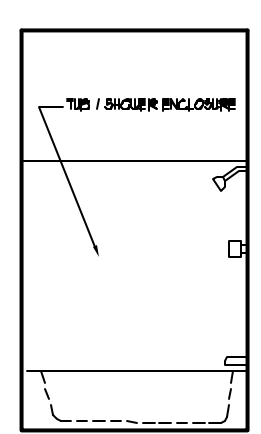
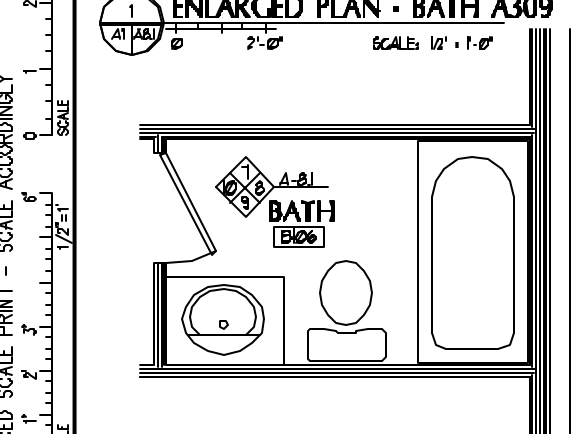
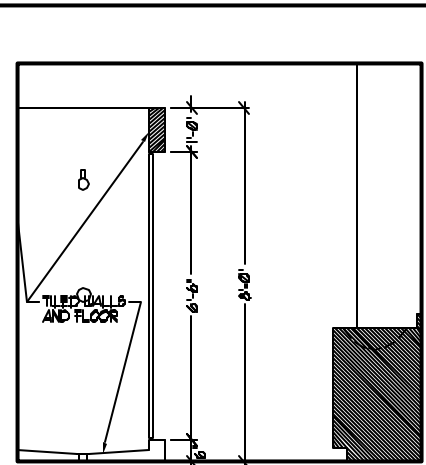
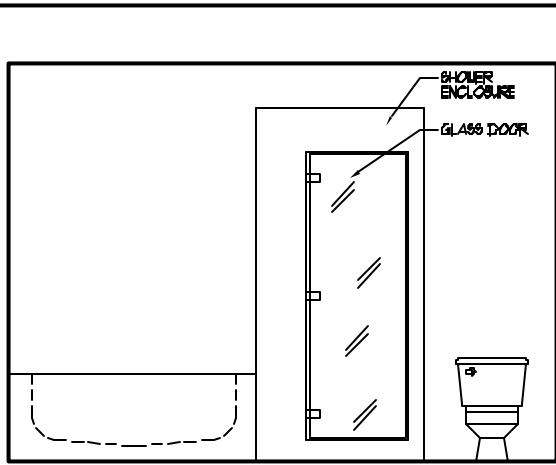
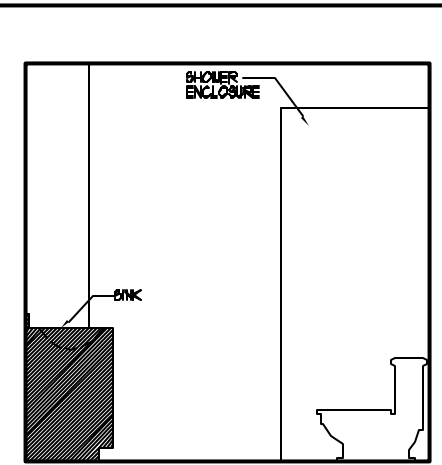
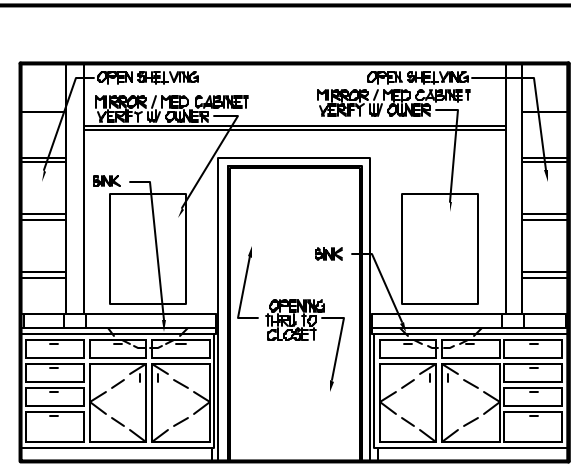
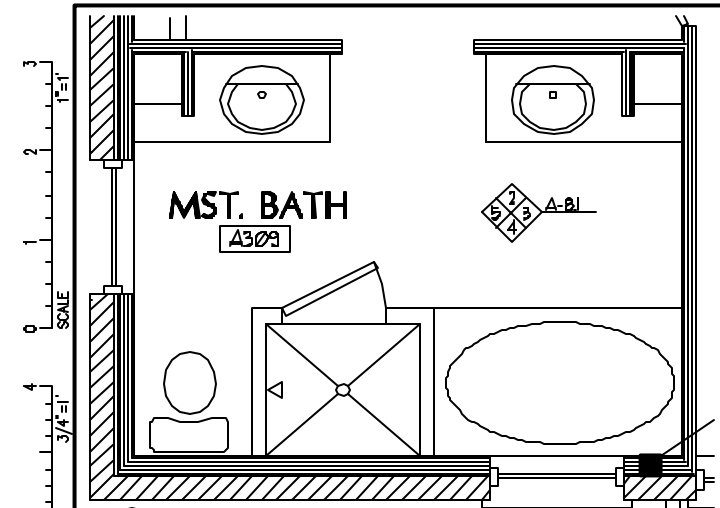

NOTE: CONTRACTOR TO FIELD VERIFY ALL DIMENSIONS AND VERIFY DIMENSIONS WITH APPLIANCES.

PORT CITY ARCHITECTURE
 65 NEWBURY STREET
 PORTLAND, ME 04101
 207.781.9000
 fax: 207.781.2010
 info@portcityarch.com

CONSULTANTS:

44 FEDERAL STREET CONDOMINIUMS
 44 FEDERAL STREET
 Portland, Maine 04101

2	11-11-06	PERMIT SET
1	06-03-06	REVIEW SET
* date description		
REVISIONS		
Date Issued	Date - Year	
Project Number	07406	
Drawing Scale		

6-BIT NAME
INTERIOR ELEV. UNITS A & B
 Drawn By
 MC
 Checked By
 ACH

A8.1

PERMIT SET - NOT FOR CONSTRUCTION