

FLOOR TRANSITION & THRESHOLD NOTES:

- SEE INTERIOR FINISH SPECIFICATIONS FOR ALL THRESHOLDS AND FLOOR TRANSITIONS.
- THRESHOLDS, FLOOR TRANSITIONS, AND DOOR SWEEPS TO BE INSTALLED PER MANUFACTURER'S SPECIFICATIONS.
- SEE ENLARGED PLANS FOR LOCATIONS.

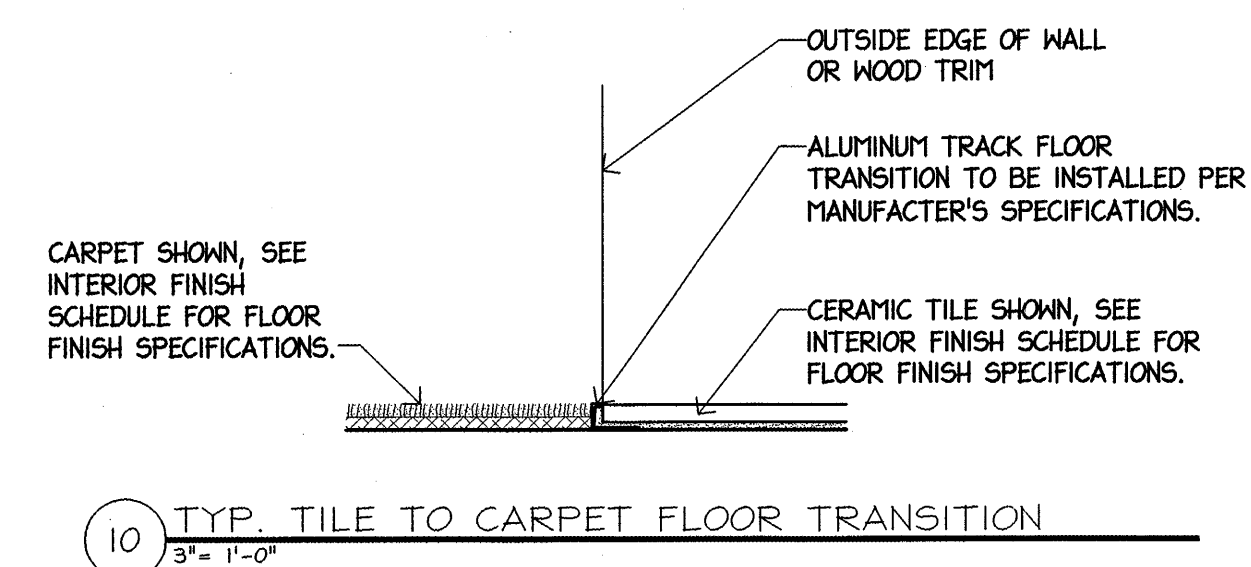
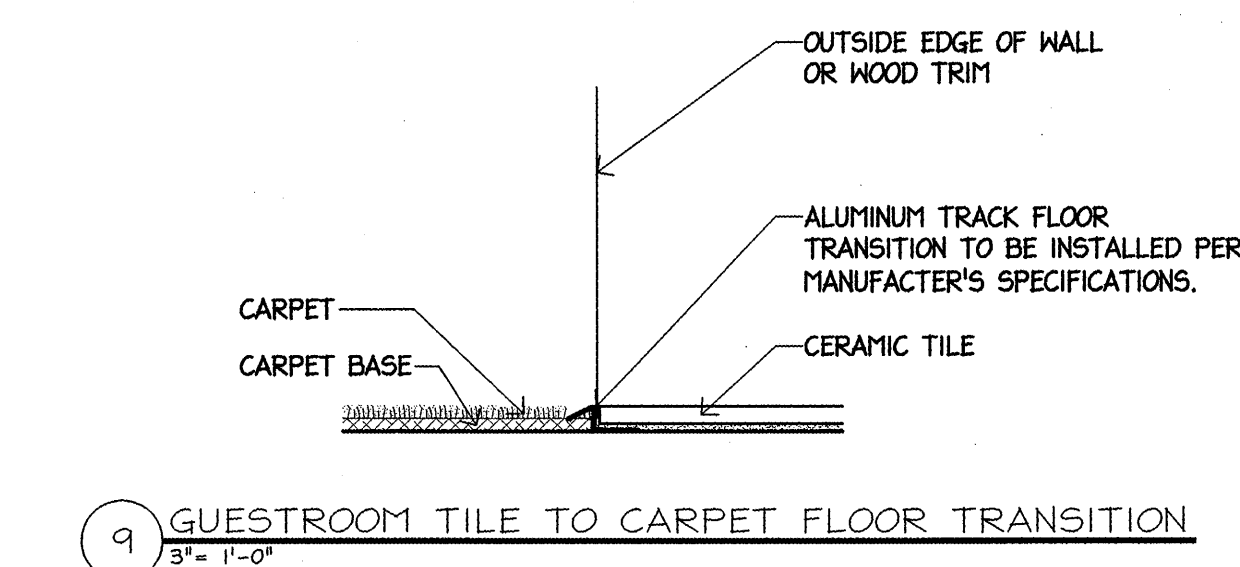
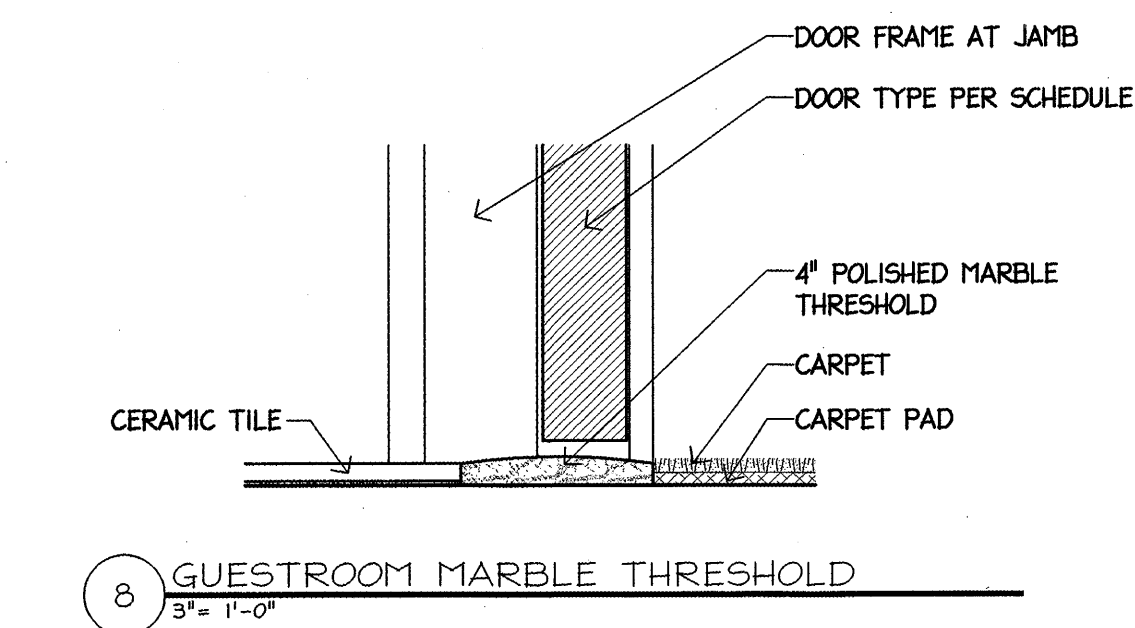
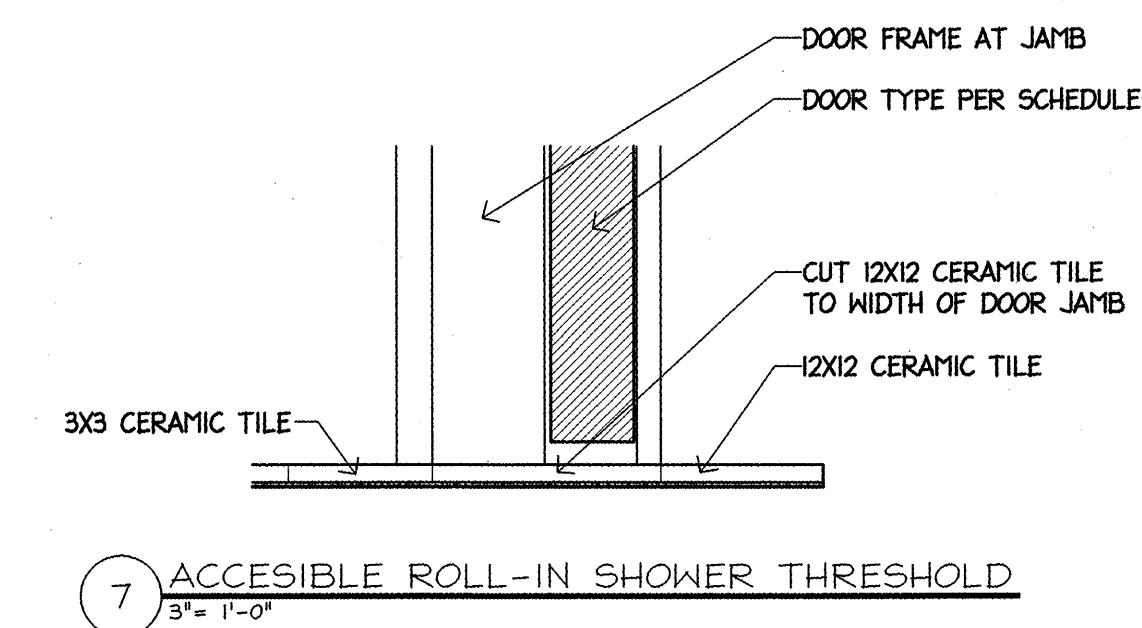
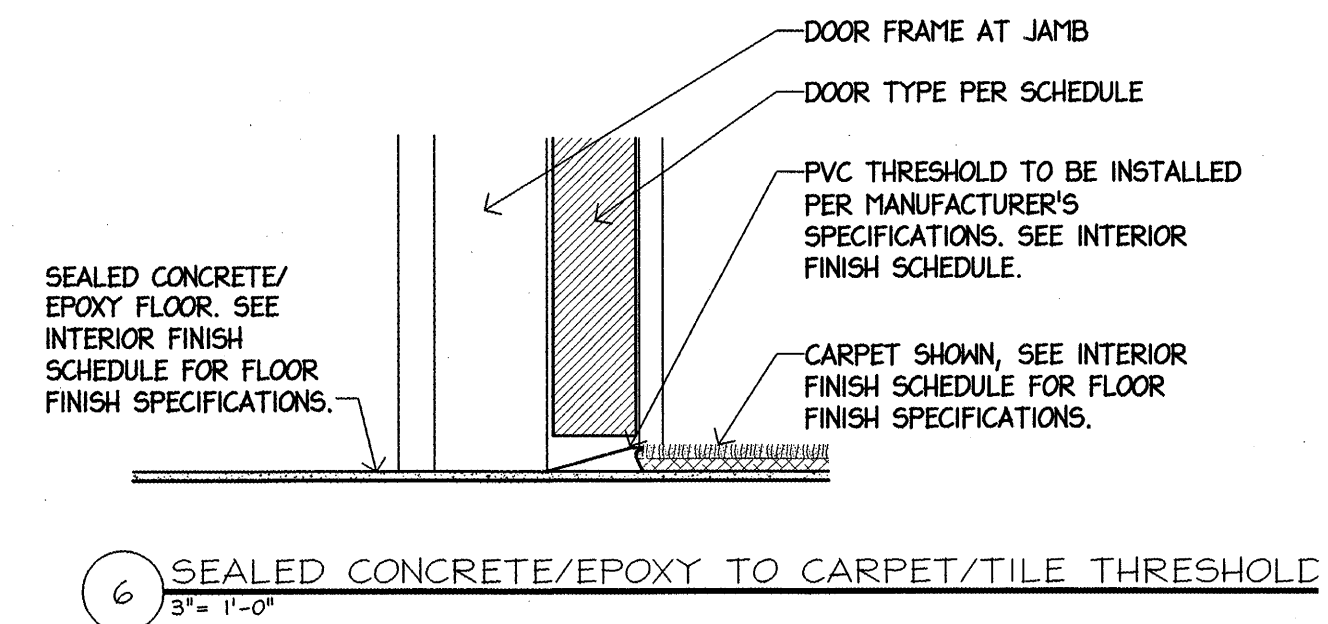
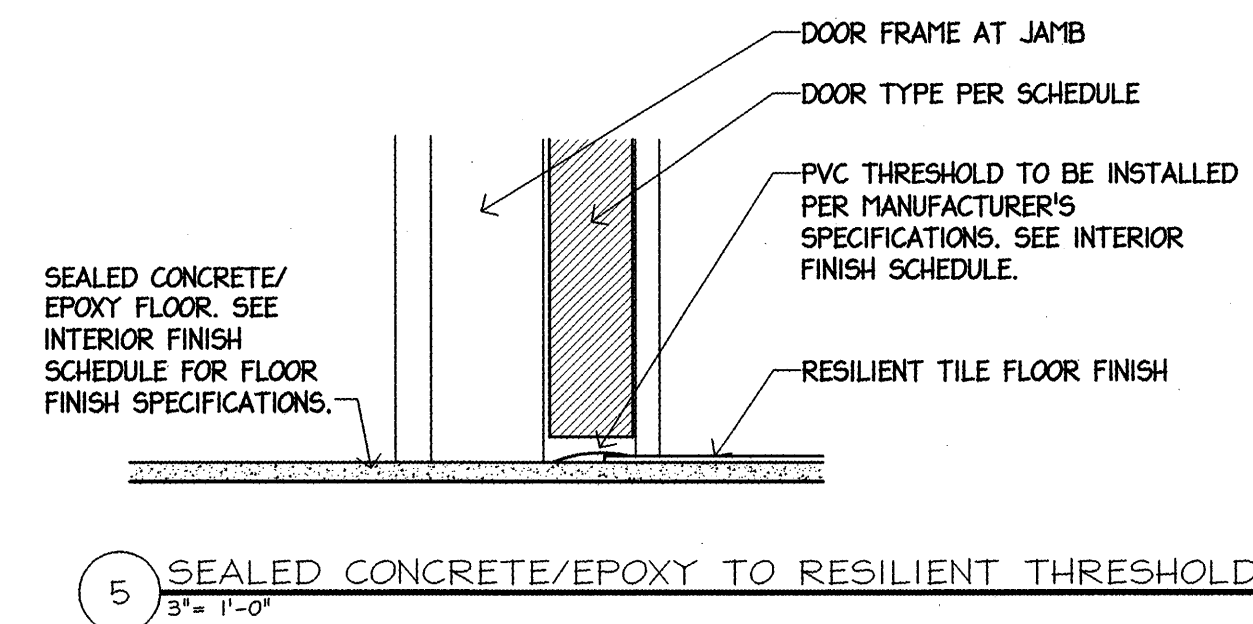
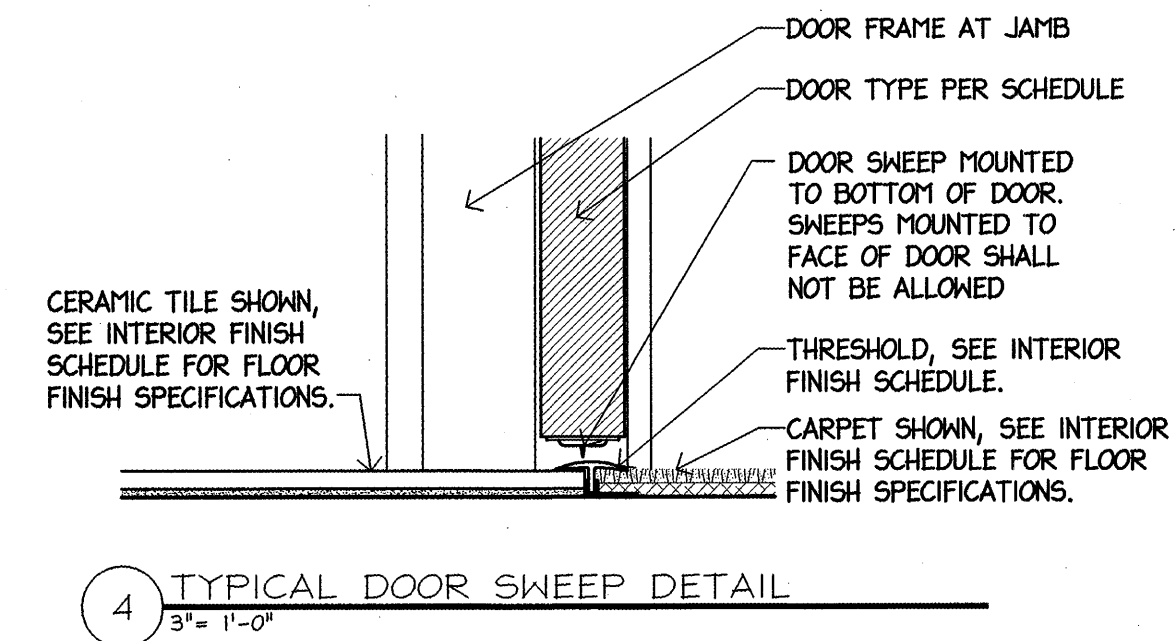
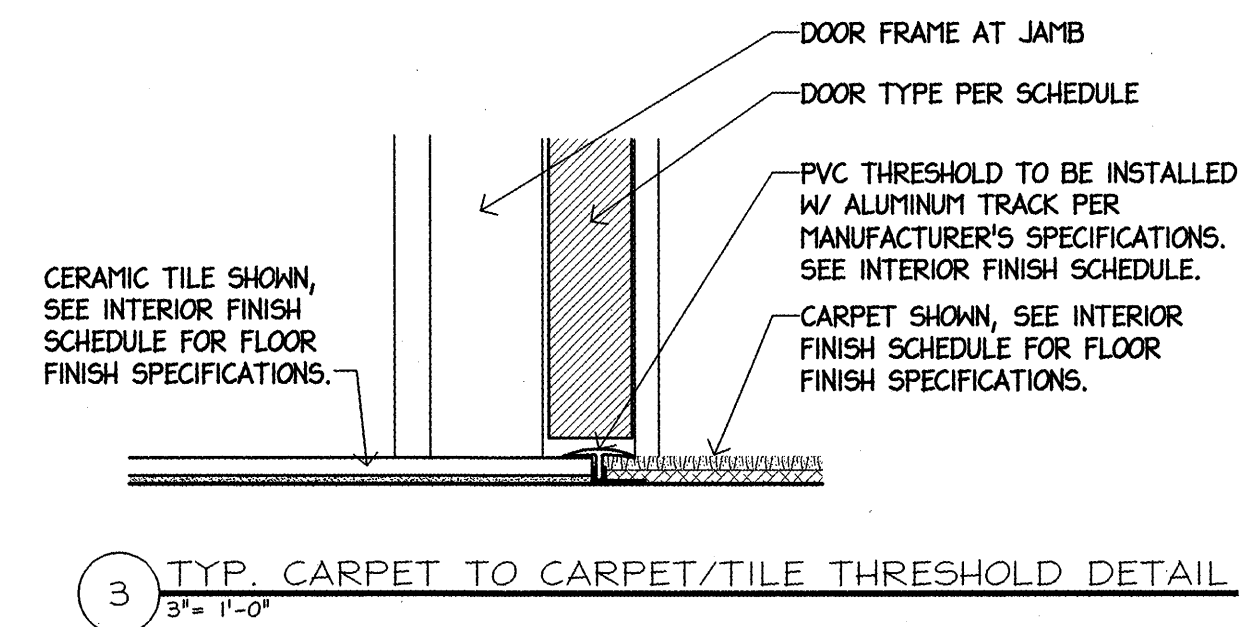

PERMIT ISSUE - 09/27/07

NO.	REVISION	DATE
SCALE: As Noted		DRAWN BY: JC
DATE:		CHECKED BY:

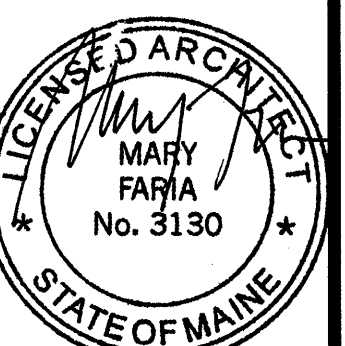

PROJECT
RESIDENCE INN BY MARRIOTT
PORTLAND, ME
JOB# 802

TITLE
THRESHOLD + FLOOR TRANSITION DETAILS

GROUP ONE
21 W. THIRD STREET, BOSTON, MA 02127
TEL: (617)268-7000 FAX: (617)268-0209

DRAWING NO.
A8.2