

ROOF EAVE DETAIL
SCALE: 1 1/2" = 1'-0"

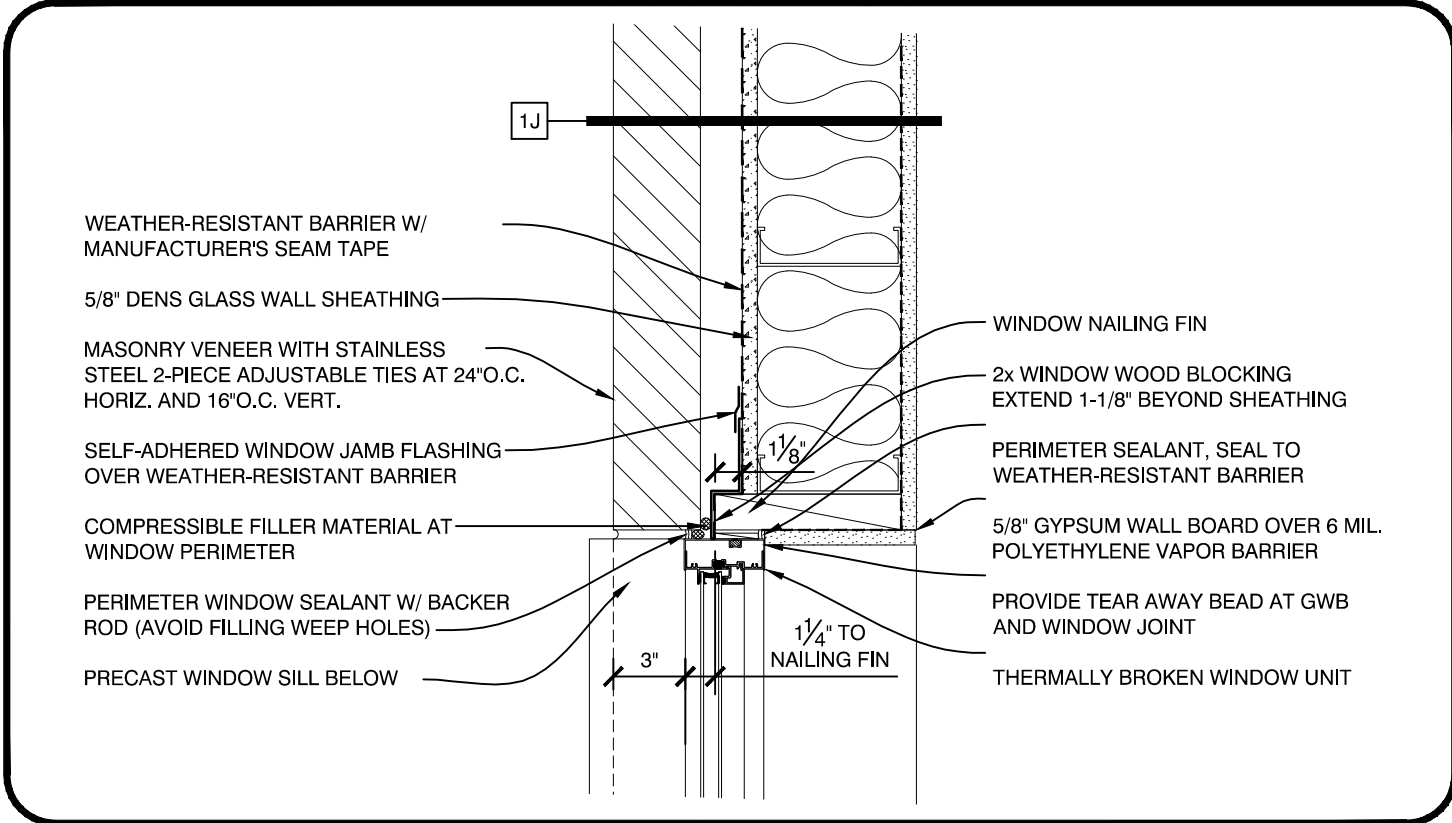

WINDOW JAMB DETAIL
SCALE: 1 1/2" = 1'-0"

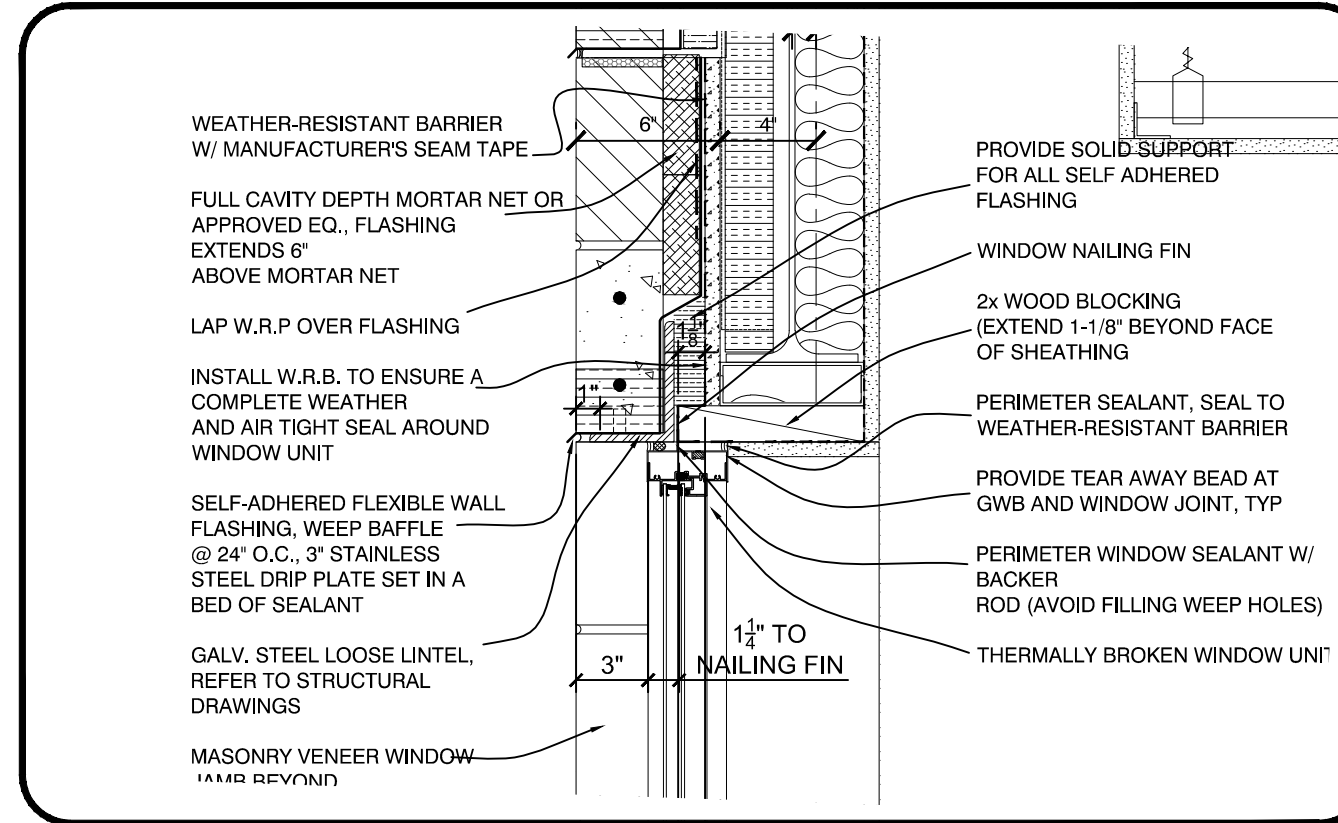

WINDOW HEAD DETAIL
SCALE: 1 1/2" = 1'-0"

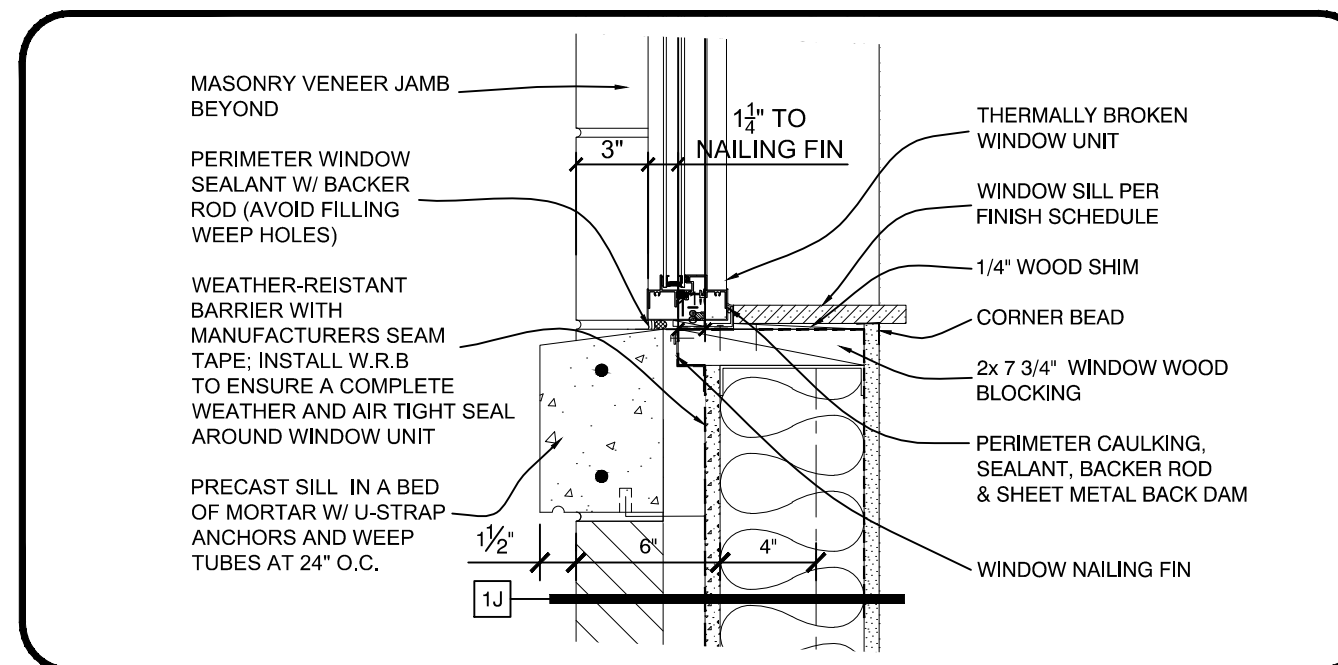

WINDOW SILL DETAIL
SCALE: 1 1/2" = 1'-0"

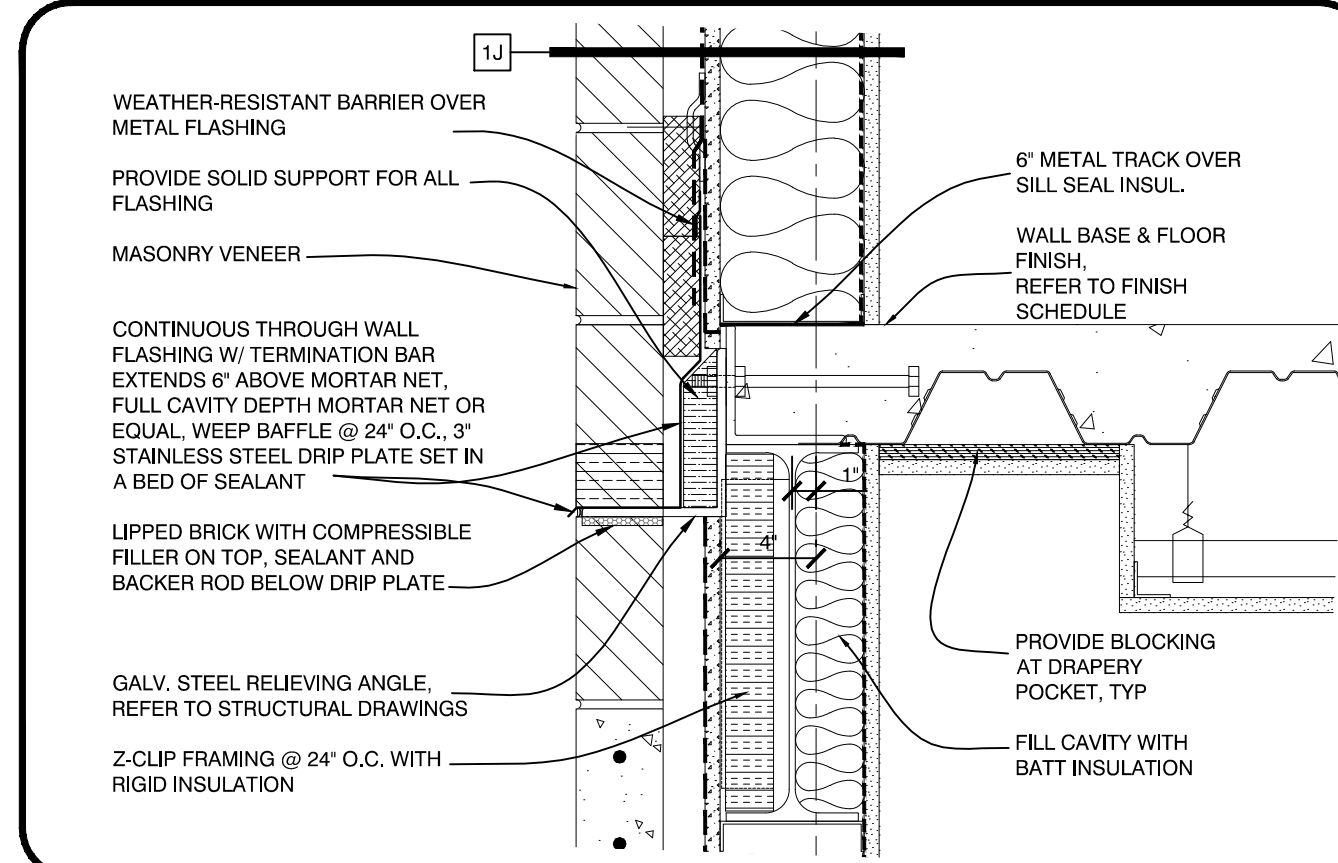

RELIEVING ANGLE DETAIL
SCALE: 1 1/2" = 1'-0"

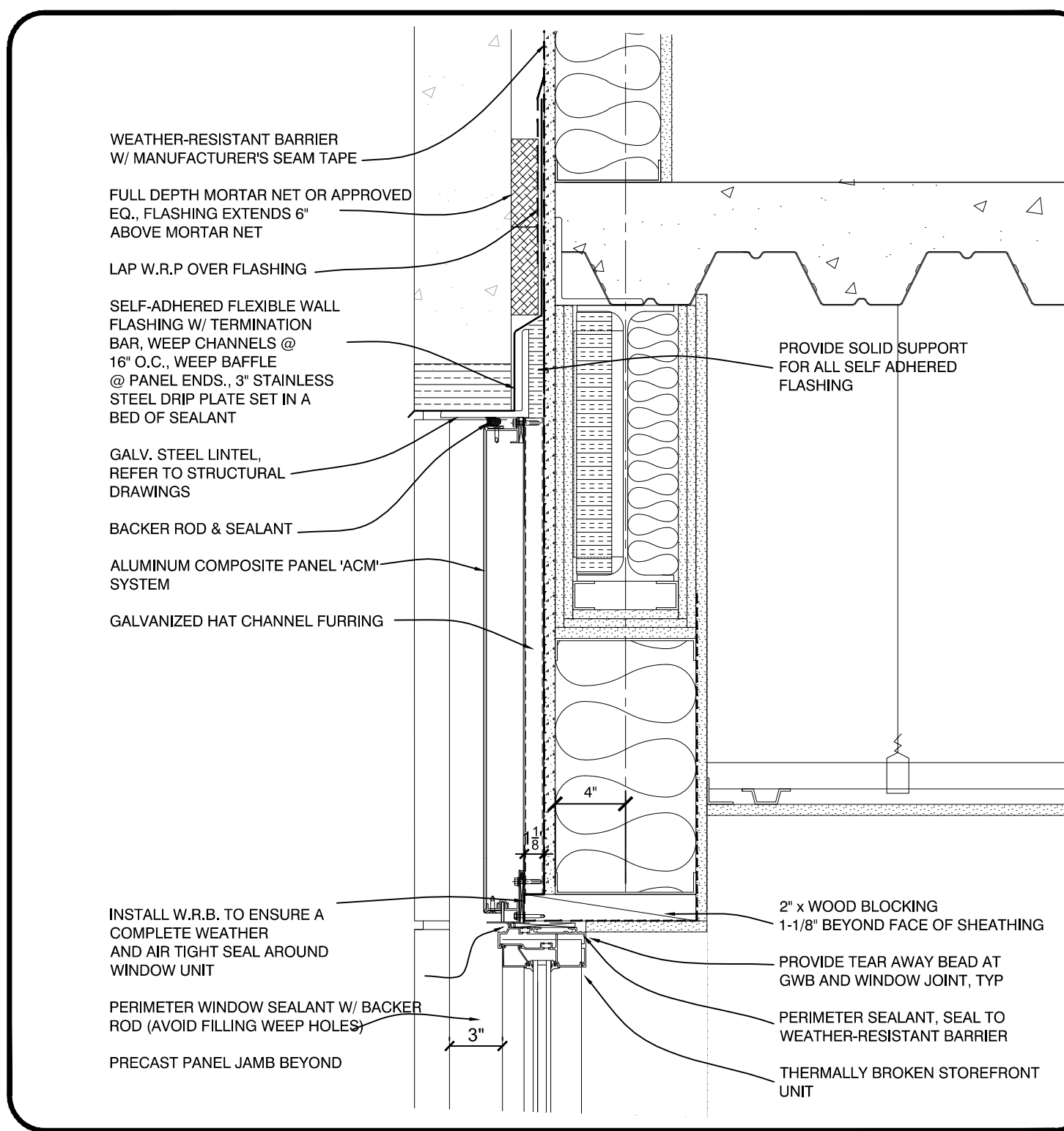

STOREFRONT HEAD DETAIL
SCALE: 1 1/2" = 1'-0"

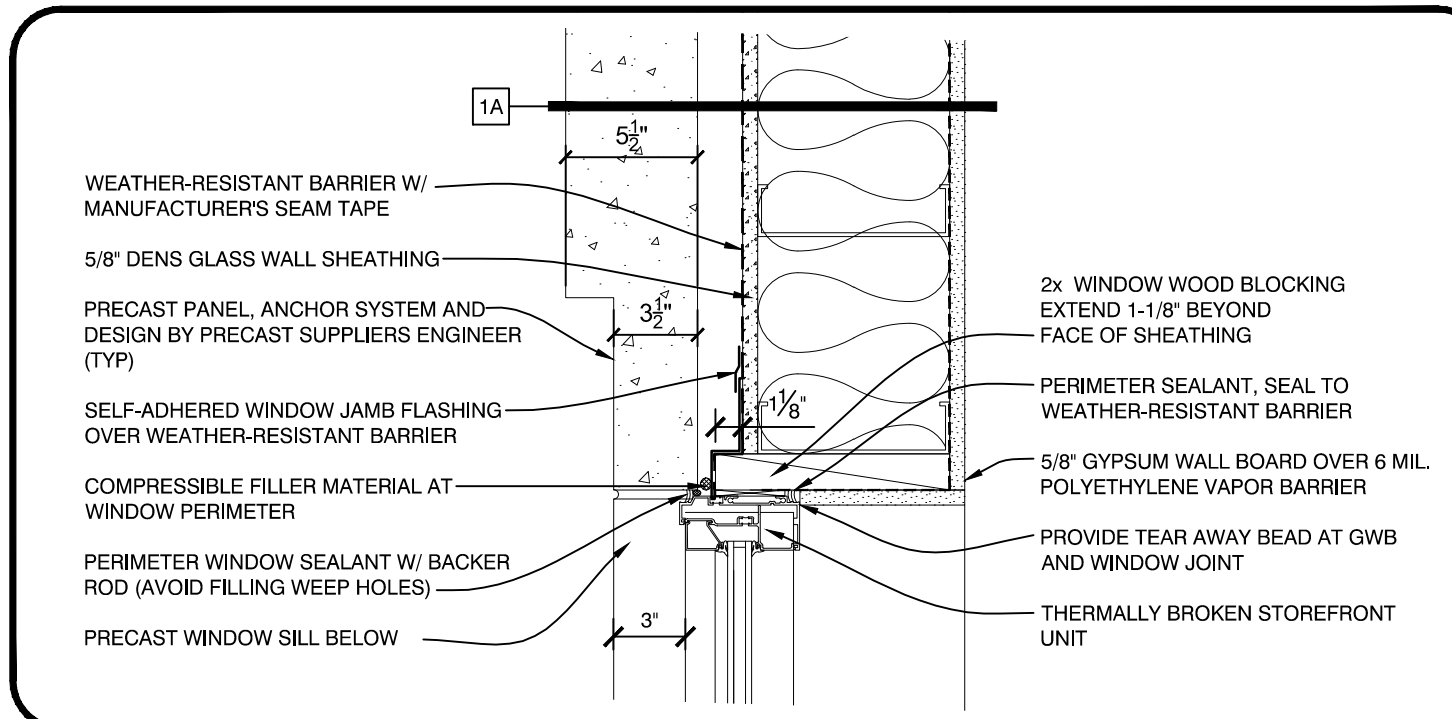

STOREFRONT JAMB DETAIL
SCALE: 1 1/2" = 1'-0"

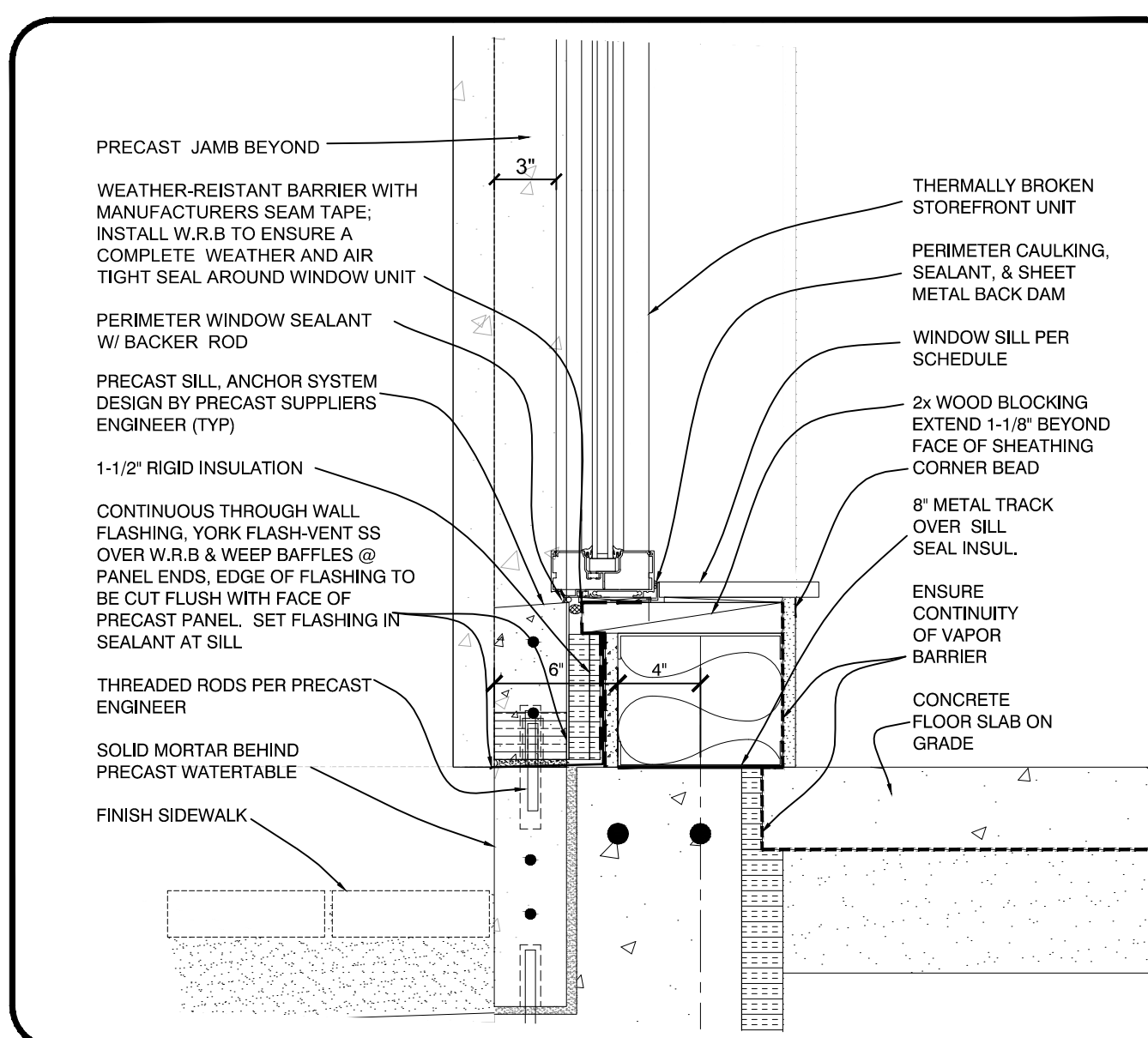

STOREFRONT SILL DETAIL
SCALE: 1 1/2" = 1'-0"

