

H ROOM ELEVATION
3/8" = 1'-0"

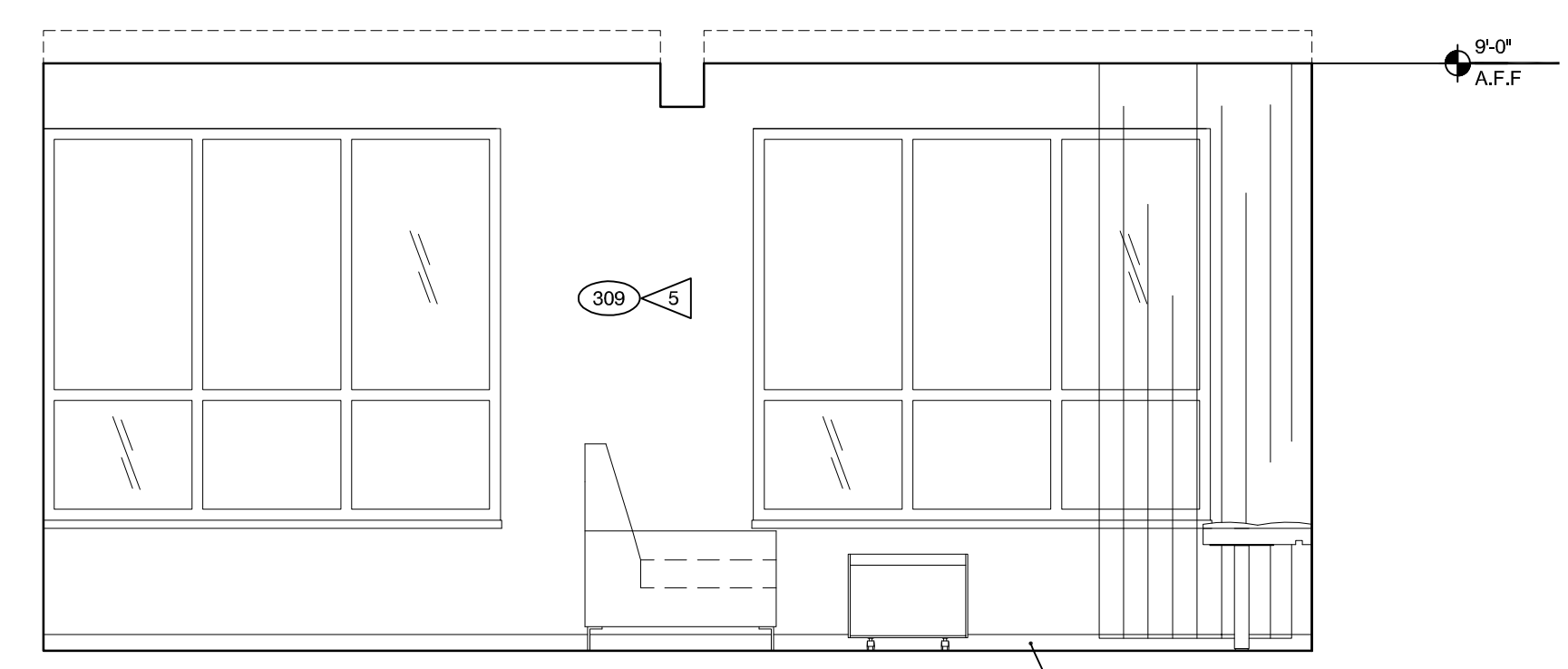

G ROOM ELEVATION
3/8" = 1'-0"

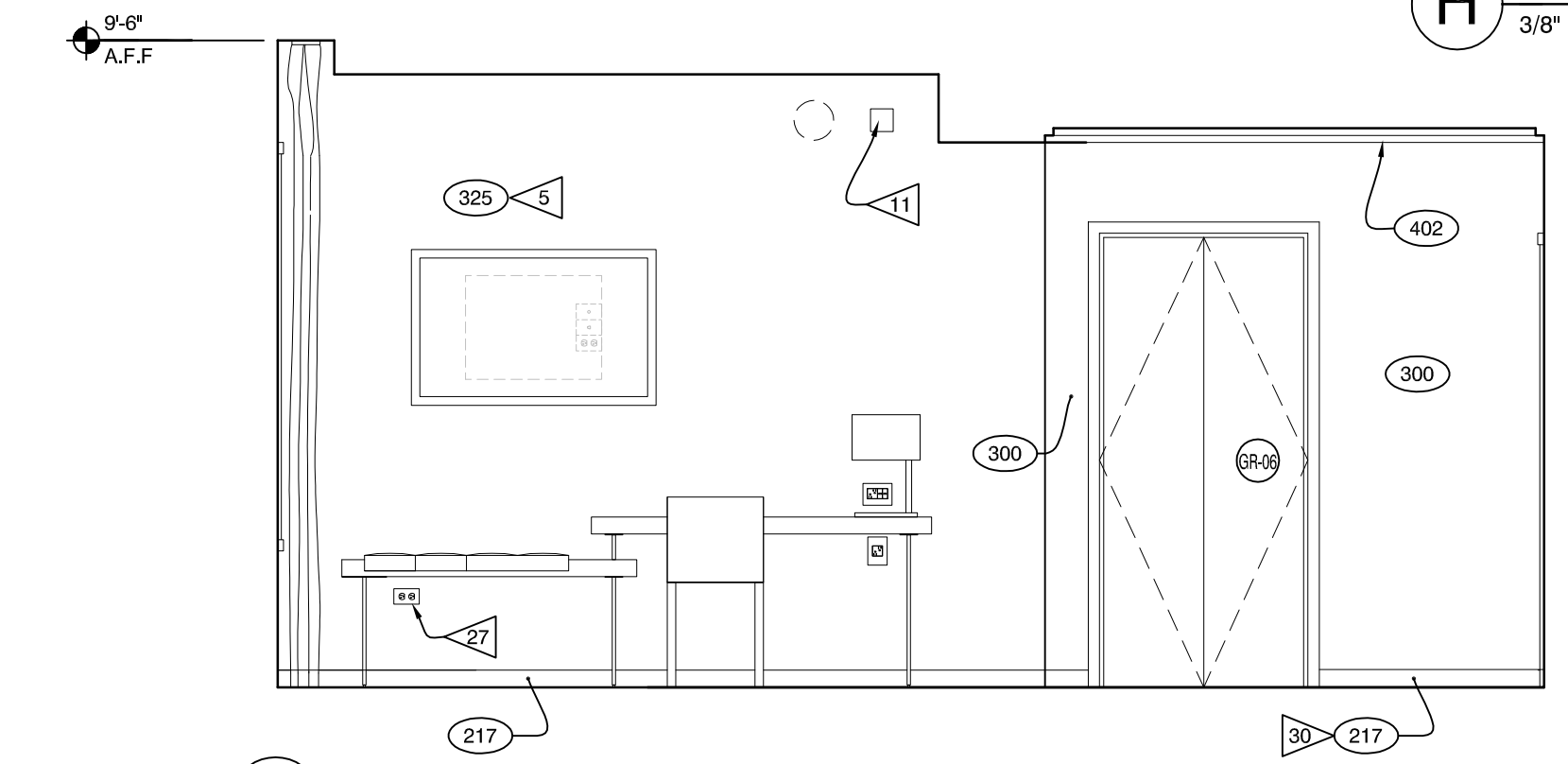

F ROOM ELEVATION
3/8" = 1'-0"

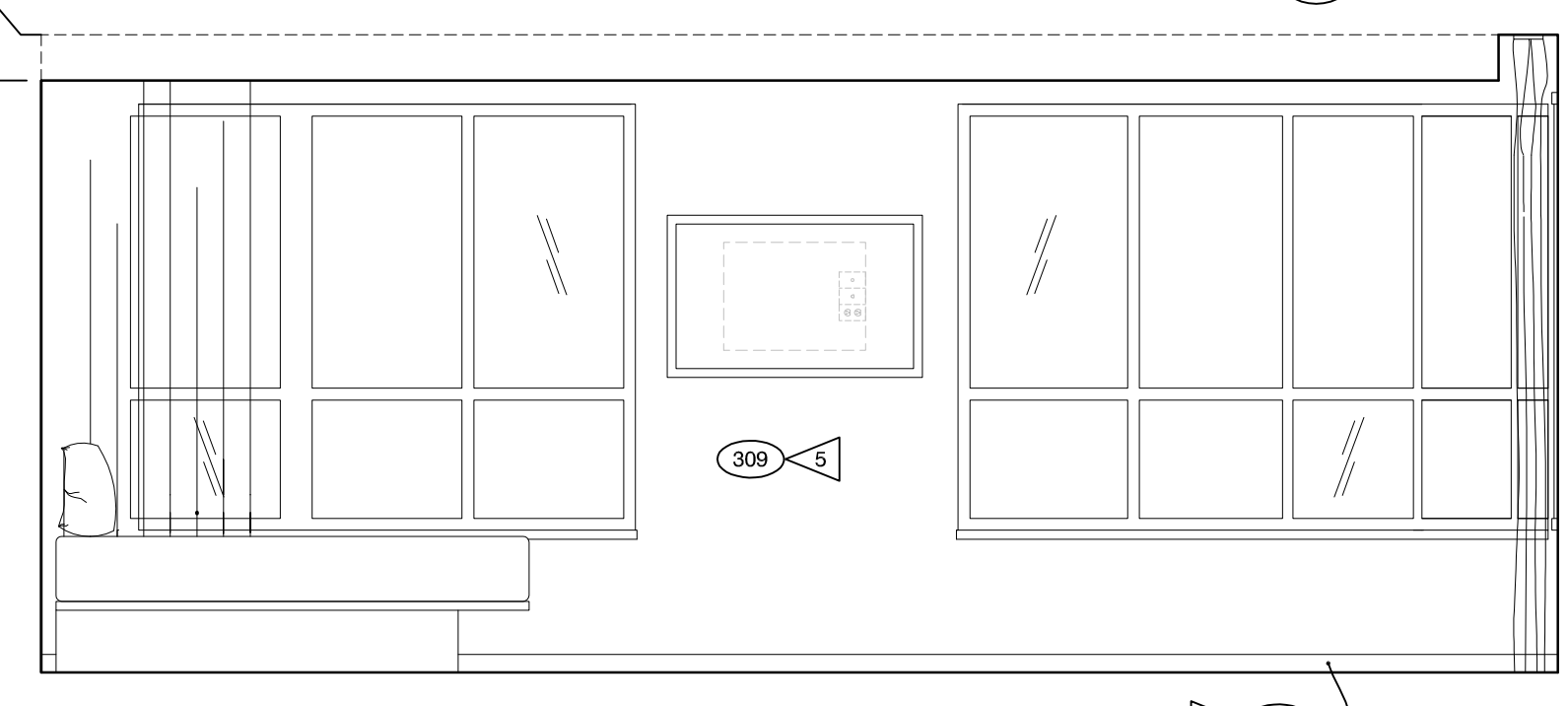

D ROOM ELEVATION
3/8" = 1'-0"

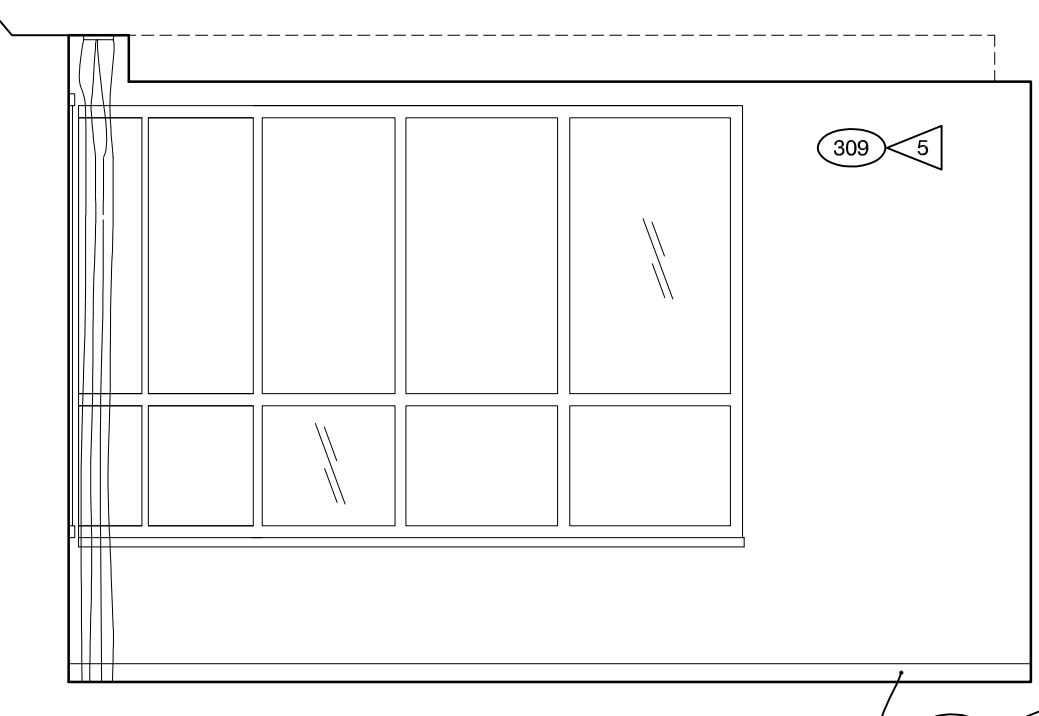

C ROOM ELEVATION
3/8" = 1'-0"

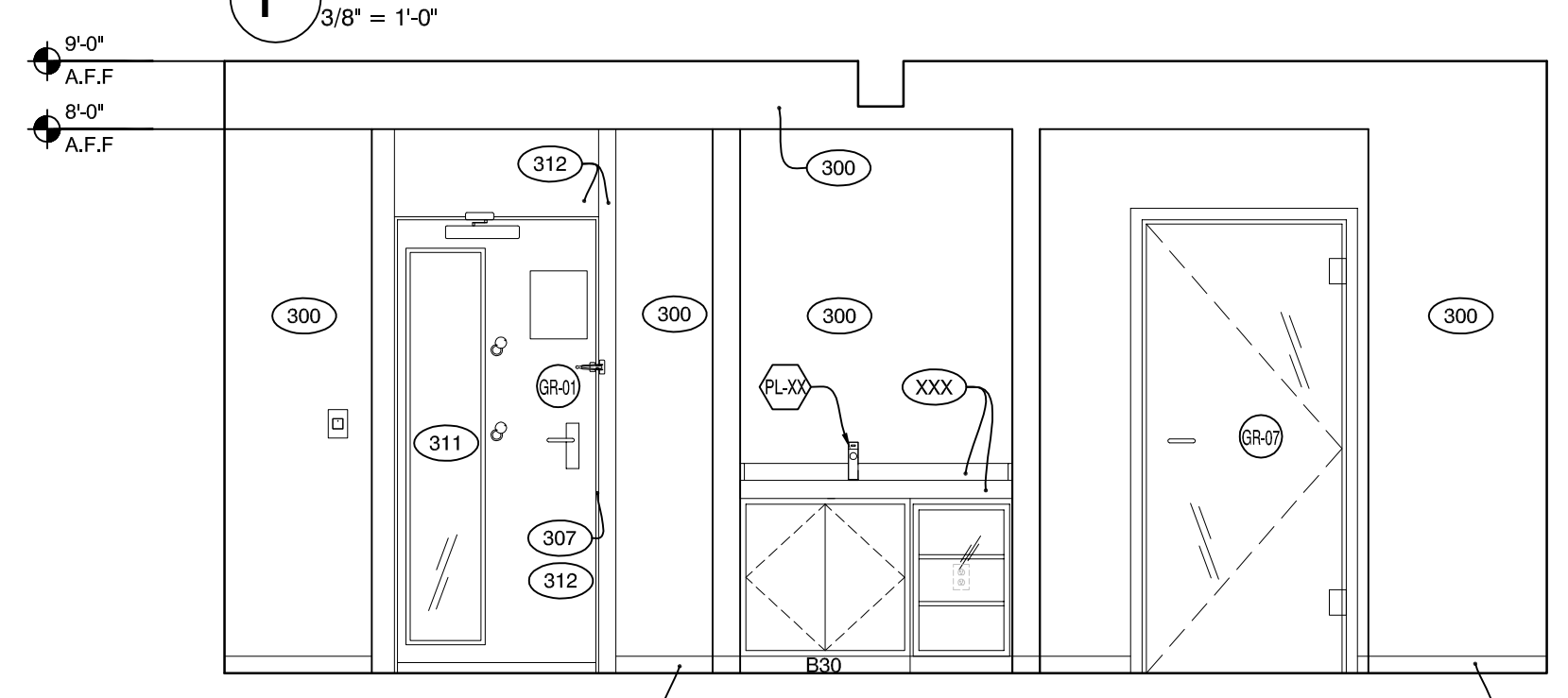

E ROOM ELEVATION
3/8" = 1'-0"

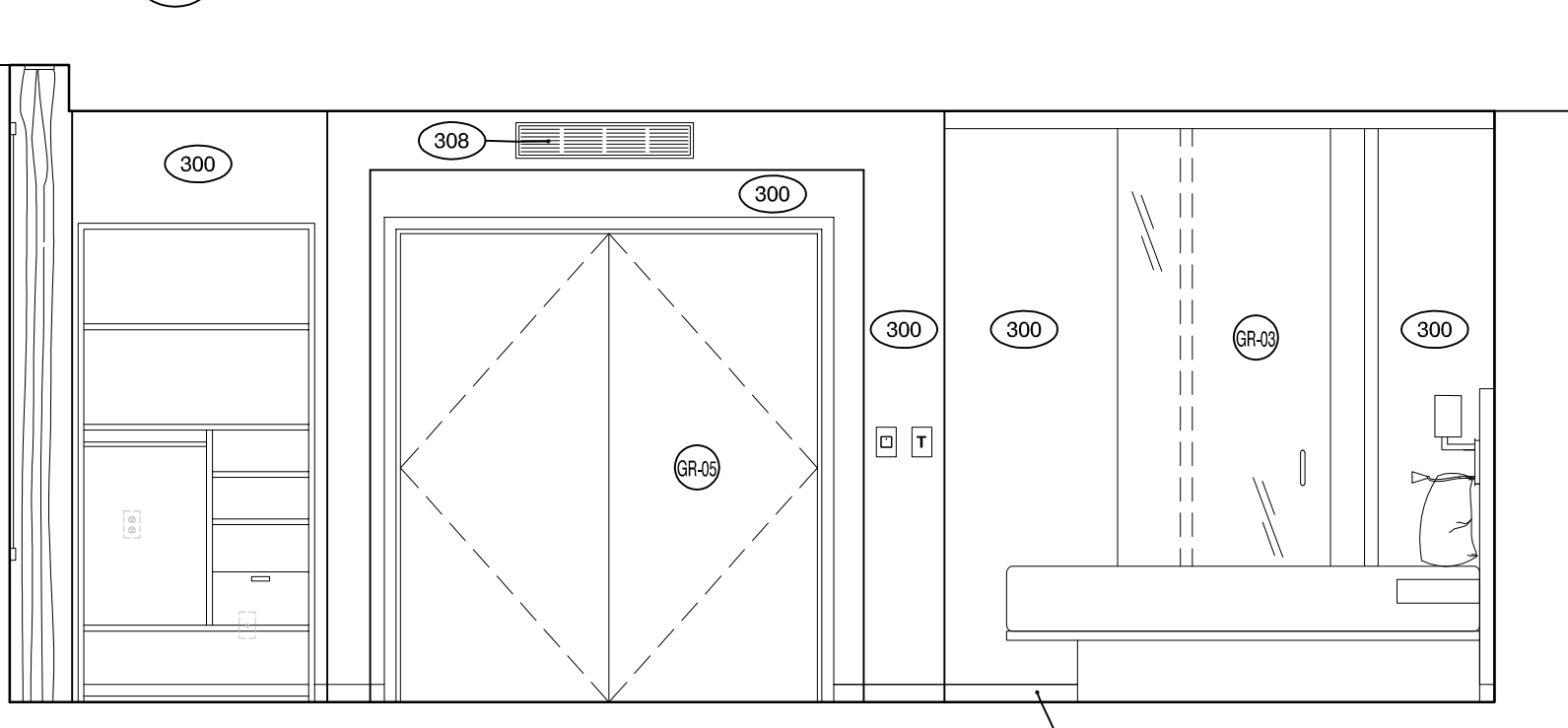

B ROOM ELEVATION
3/8" = 1'-0"

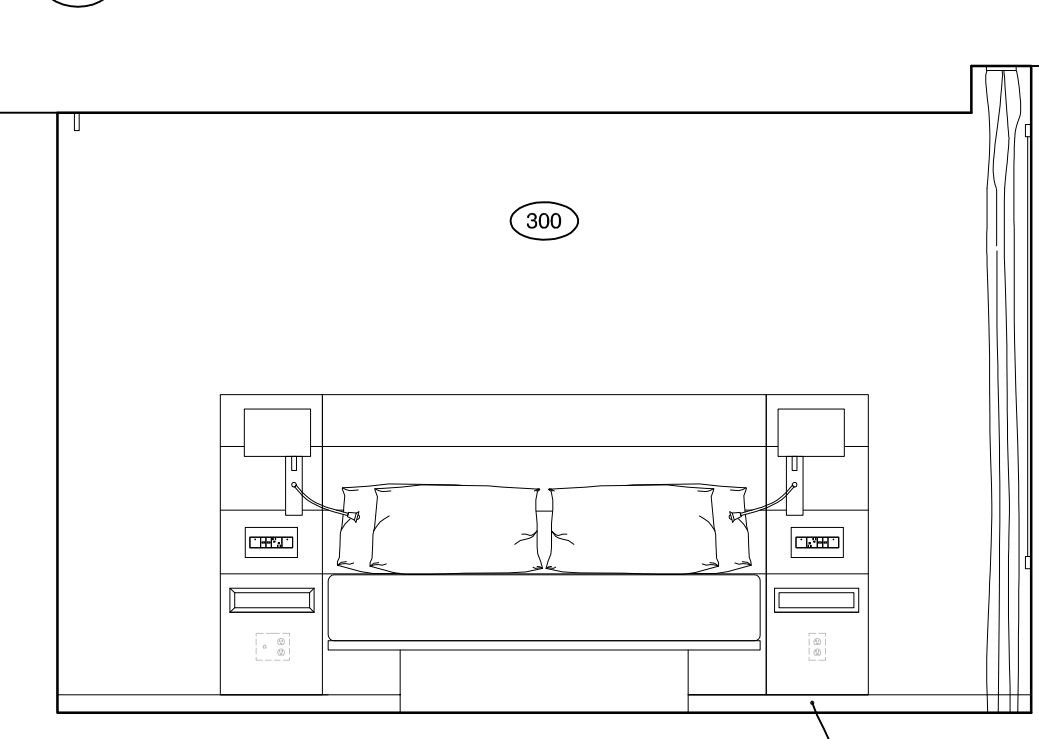

A ROOM ELEVATION
3/8" = 1'-0"

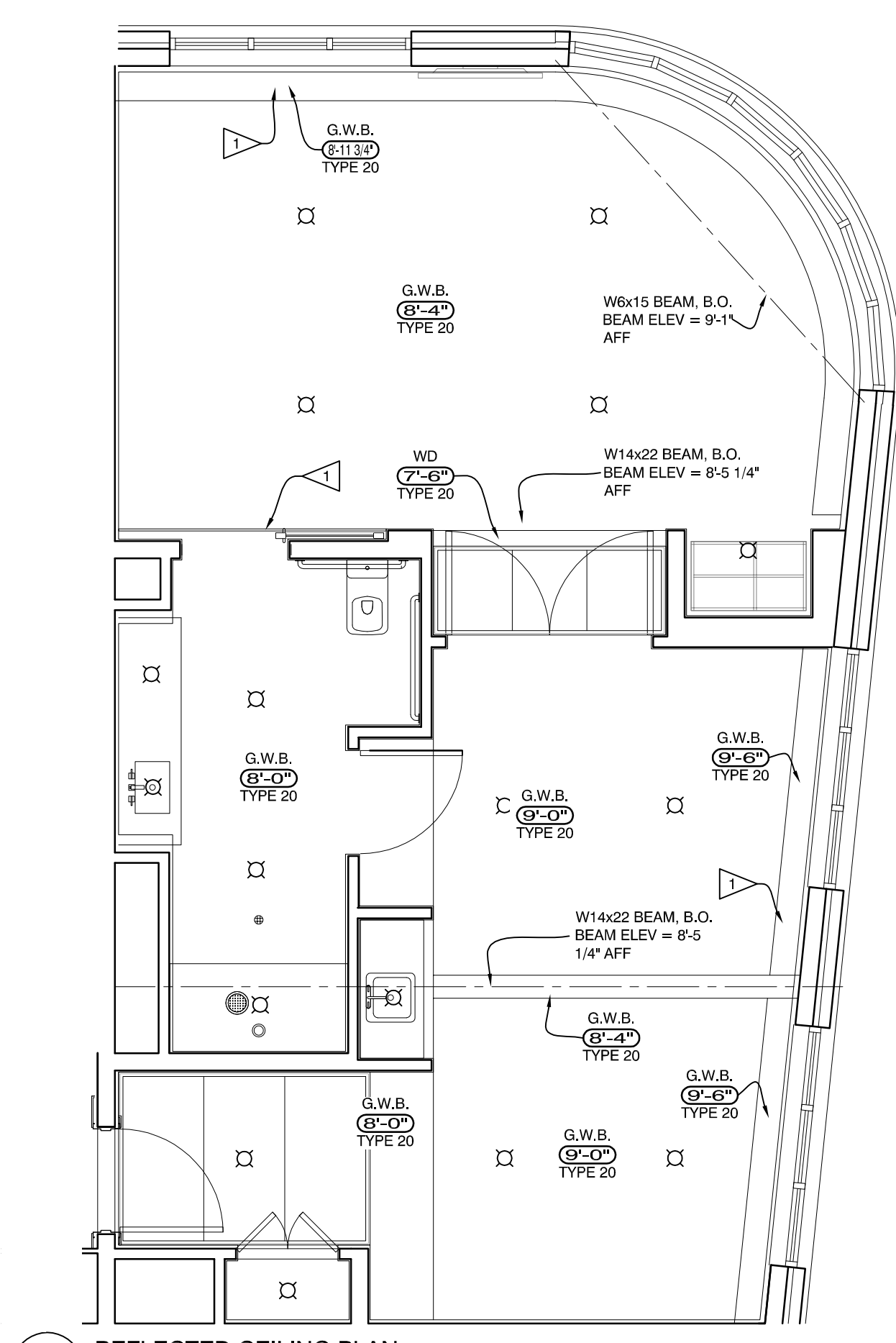

3 REFLECTED CEILING PLAN
1/4" = 1'-0"

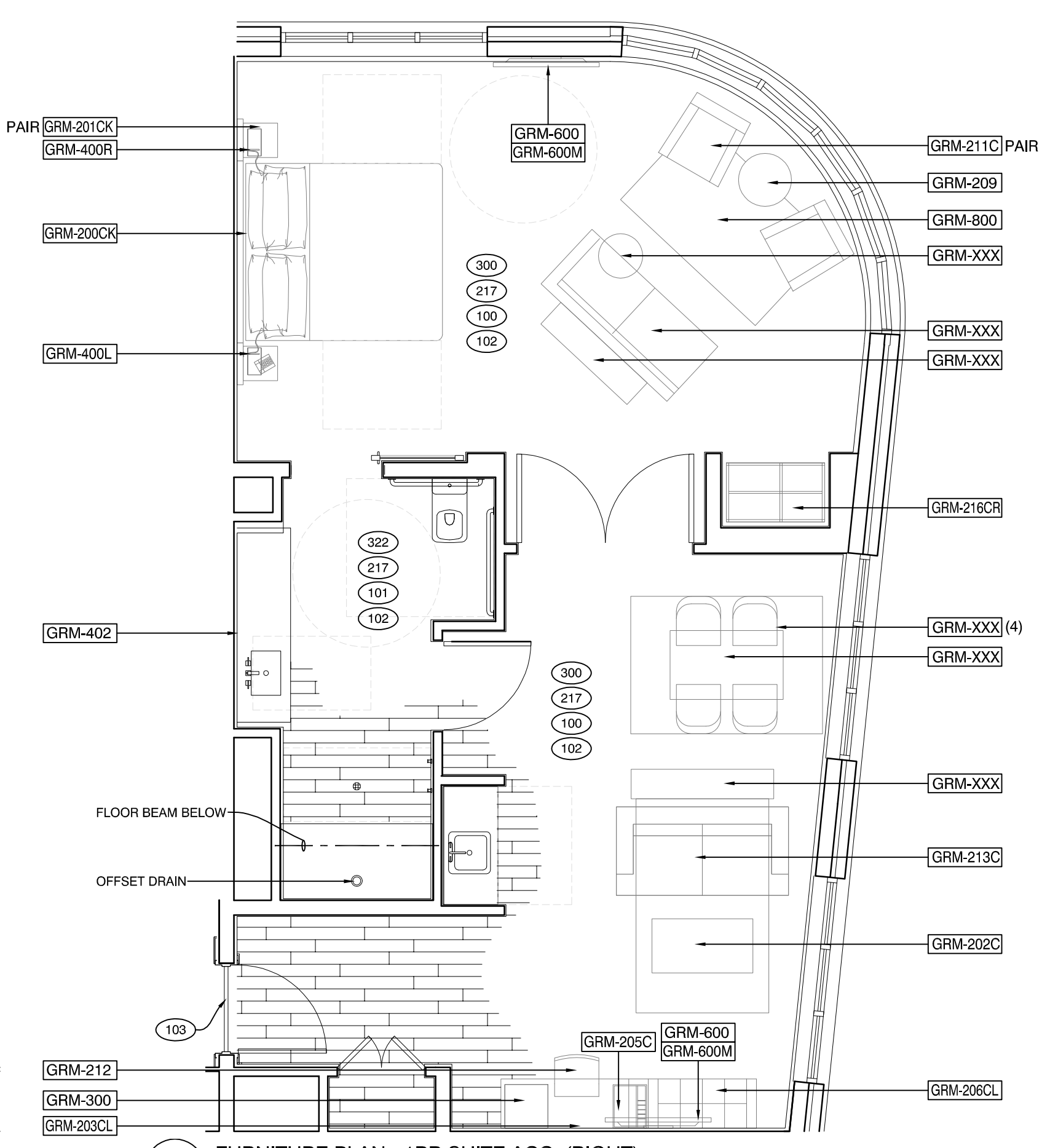

2 FURNITURE PLAN - 1BR SUITE ACC. (RIGHT)
1/4" = 1'-0" RIGHT (HEARING): 344

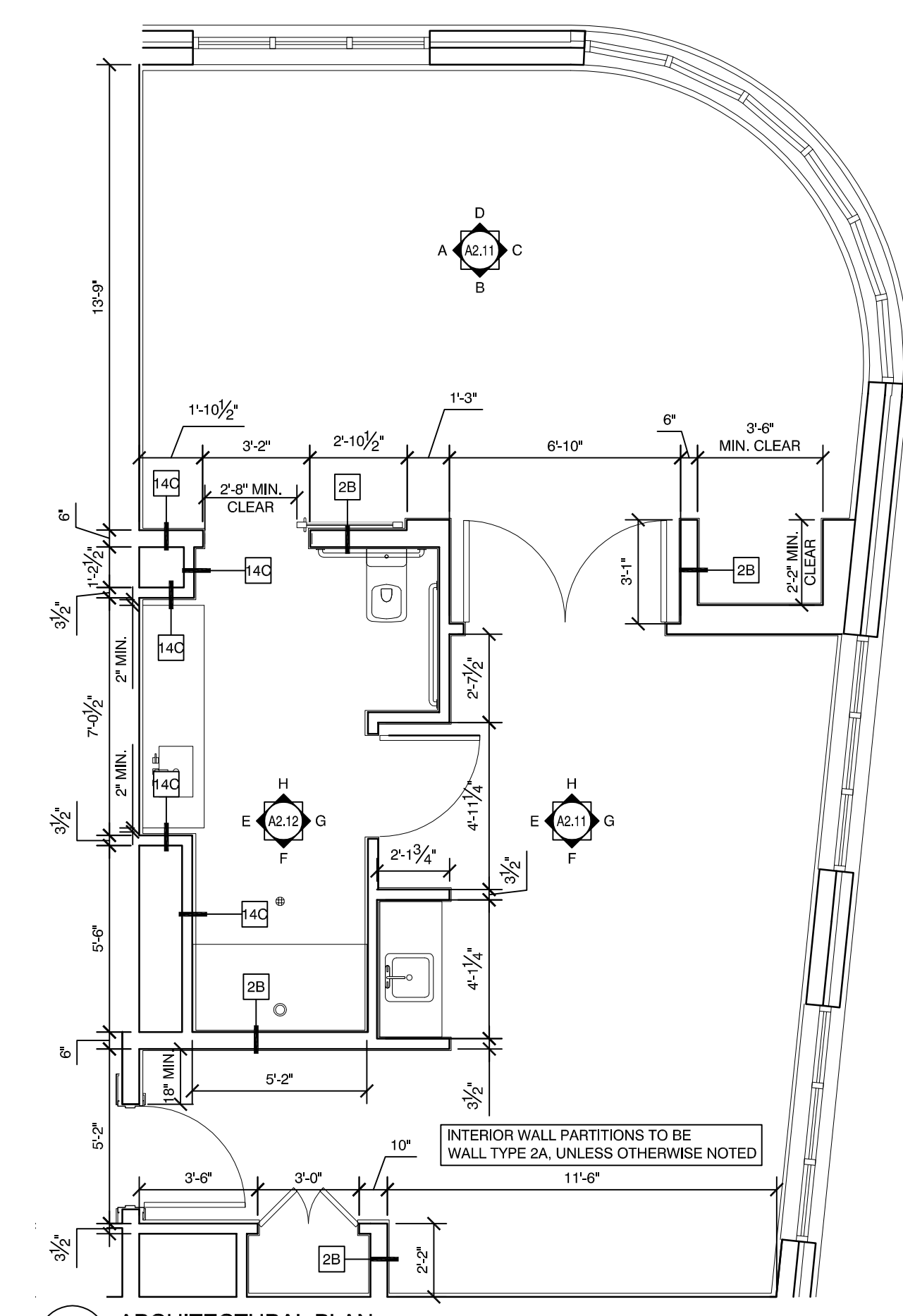

1 ARCHITECTURAL PLAN
1/4" = 1'-0"

SYMBOL LEGEND

- (XX) DOOR TAG
-REFER TO SHEET A6.04
- (XXX) FINISH TAG
-REFER TO DESIGN GUIDE PROJECT MANUAL MASTER
- (XX) ACCESSORY TAG
-REFER TO SPEC SECTION 10800
- (XX) WALL TAG
-REFER TO SHEET L8.2.01
- X-000 FURNISHING REFERENCE - REFER TO INTERIOR DESIGN SPECIFICATIONS
- XX-00 M.E.P. COMPONENT REFERENCE - REFER TO IPFS
- J JUNCTION, PULL OR TAP BOX, CEILING, WALL OR FLOOR MOUNTED
- ▽ TELEPHONE OUTLET
- DATA JACK
- TV OUTLET, FLUSH MOUNTED.
- DUPLEX RECEPTACLE, 20A 125V .3W., WALL MOUNTED NEMA 5-20R.
- RECESSED CEILING LIGHTS.
- USB OUTLET
- MOTION SENSOR
- ⊖ THERMOSTAT

REFERENCE NOTES

1. REFER TO INTERIOR PRODUCT AND FINISH SPECIFICATIONS.
2. ELECTRICAL OUTLETS SHOWN ON ELEC/PLUMBING/MECH PLAN AND ON ELEVATIONS ARE TO BE LOCATED AS SPECIFIED. ADDITIONAL OUTLETS MAY BE REQUIRED BY LOCAL BUILDING CODES.
3. ELECTRICAL OUTLETS ARE MOUNTED AT STANDARD HEIGHT OF 18" UNLESS NOTED OTHERWISE.
4. SWITCHES AND THERMOSTATS TO BE LOCATED AT 48" CENTERLINE AFF UNLESS NOTED OTHERWISE.
5. REFER TO GUESTROOM ELEVATIONS FOR MOUNTING CONFIGURATIONS OF OUTLETS. COORDINATE FINAL LOCATIONS WITH CASEGOODS.
6. SOME PRODUCTS, FIXTURES AND FURNITURE ITEMS ARE HANDED (LEFT OR RIGHT), DESIGNER TO COORDINATE, WHERE APPLICABLE.
7. ALL DIMENSIONS ARE FROM FACE OF FINISH TO FACE OF FINISH, U.N.O. HOLD ALL CLEAR INTERIOR ROOM DIMENSIONS.
8. WATER CLOSET WASTE LINES ARE TO BE LOCATED IN WALL CHASE, NOT IN EXTERIOR WALLS.

CRITERIA NOTES

- 1 PROVIDE CONTINUOUS SOLID WOOD BLOCKING IN CEILING FOR DRAPERY ATTACHMENT AND SLIDING DOOR TRACKS.
- 2 COORDINATE PARTITION DIMENSIONS WITH HVAC EQUIPMENT & CONFIGURATION.
- 3 PROVIDE METAL TRIM TRANSITION (316) AT ALL OUTSIDE CORNERS OF BATHROOM.
- 4 IRONING BOARD MOUNT (316) & IRON RACK MOUNT (328) TO BE COORDINATED WITH CLOSET INSERT.
- 5 PROVIDE ACCENT VINYL (322)
- 6 SUPPLY VALVE FOR WATER CLOSET SHALL BE LOCATED OPPOSITE ENTRY.
- 7 COORDINATION BY HEADBOARD INSTALLER & ELECTRICIAN WILL BE REQUIRED AND MAY REQUIRE NUMEROUS VISITS BY BOTH TRADES.
- 8 WALL OUTLETS SHALL NOT OCCUR IN SAME WALL CAVITY OF ADJACENT GUESTROOMS. SEE DETAIL AT OFFSET OUTLET LOCATIONS ON E2.01.
- 9 PROVIDE BLOCKING FOR ACCESSORIES, EQUIPMENT, AND FFBE AS REQUIRED.
- 10 MASTER SWITCH WITH SIGNAGE TO CONTROL HARDWIRED LIGHTS AND SWITCHED OUTLETS IN GUESTROOM, WITH EXCEPTION OF BATHROOM. WIRE AHEAD OF INDIVIDUAL SWITCHES. SEE E2.02 FOR DETAIL.
- 11 AT HEARING IMPAIRED ROOM ONLY.
- 12 PROVIDE CHROME TRAP AND WASTE LINE. LOCATE SUPPLY VALVES AS HIGH AS POSSIBLE. BELOW VANITY; PROVIDE A CABLE MANAGEMENT SYSTEM TO CONTAIN THE SST SUPPLY LINES.
- 13 NOT USED
- 14 PAINT EXTERIOR WINDOW WALL (309) WITH MOLD AND MILDEW TEXTURED FINISH.
- 15 SIZE AND LOCATION OF EXTERIOR WINDOW TO BE ACCEPTED BY MARRIOTT.
- 16 ARCHITECT TO REVIEW DOOR & SHOWER ASSEMBLY SHOP DRAWINGS IN IPFS FOR LATEST INFORMATION (INCLUDING DIMENSIONS & FINISHES). FOR CUSTOM VANITIES, ARCHITECT TO OBTAIN ACCEPTANCE FROM MARRIOTT REVIEW TEAM. ARCHITECT TO PROVIDE VANITY SUPPORT DESIGN. SUPPORT DESIGN SHOULD COMPLY WITH LOCAL CODES.
- 17 NOT USED
- 18 4-WAY/3-WAY SWITCH AT HEADBOARD AND GUESTROOM ENTRY. WIRED TO OVERHEAD ENTRY & CLOSET LIGHTS. SEE E2.02 FOR DETAILS.
- 19 REMOVABLE CEILING PANELS.
- 20 DRAPERY PULL WANDS ARE LOOP TYPE HANDLES AND 48" MAX A.F.F.
- 21 ANY GAP LEFT BETWEEN THE FLOORING MATERIAL AND THE GUESTROOM WALL SHOULD BE NO MORE THAN A 1/2" SO THAT THE BASE WILL COMPLETELY COVER THIS GAP.
- 22 SECURE VANITY BASE TO FLOOR AND WALL. SECURE VANITY MIRROR TO CEILING. PROVIDE BLOCKING AS REQUIRED.
- 23 WRAP DRAINAGE AND SUPPLY PIPES WITH INSULATING MATERIAL.
- 24 PROVIDE (2) GFCI RECEPTACLES (EL-12) ABOVE COUNTER BACKSPLASH. CONNECT TOGETHER TO A DEDICATED SINGLE 120V CIRCUIT.
- 25 ARCHITECT TO REVIEW DOOR & SHOWER ASSEMBLY SHOP DRAWINGS IN IPFS FOR LATEST INFORMATION (INCLUDING DIMENSIONS & FINISHES). FOR MODIFYING SHOWERS ASSEMBLIES & DOORS, ARCHITECT TO OBTAIN ACCEPTANCE FROM MARRIOTT REVIEW TEAM.
- 26 RECESSED LIGHTS ABOVE VANITY SHALL BE LOCATED WITHIN 6" OF WALL.
- 27 STANDARD SWITCHED OUTLET SERVING LED STRIP LIGHT (L1) & NIGHT LIGHT (L2), MOUNTED ±18" AFF. ROTATED 90°, COLOR MATCH WC (322). SEE SHEET E2.02 FOR DETAILS.
- 28 NIGHT LIGHT (L2) UNDER BENCH TO BE PLUGGED INTO ADJACENT OUTLET SO THAT PLUG CONTROLLING NIGHTLIGHT (L2) IS CONTROLLED BY SWITCH (EL-15).
- 29 HOLES FOR LIGHTS IN CEILING PANELS TO BE CUT IN FIELD.
- 30 BASE BOARD CAN BE PURCHASED THROUGH MARRIOTT AND IS IN THE ID SPEC MANUAL.
- 31 REFRIGERATOR DOOR TO BE INSTALLED, SUCH THAT, DOOR SWINGS TOWARDS ADJACENT WALL.
- 32 ELECTRICAL DEVICES FOR TV SHOULD NOT BE PROPRIETARY.
- 33 LOW-VOLT, WIRELESS ACCESS POINT