



PO Box 2551
2257 West Broadway
South Portland, ME 04106

1.800.370.3473
fax 207.879.0540

www.norrisinc.com

Please fax this information to the Administrative Sales Assistant at the So. Portland Office at (207)-879-0540.

Building Owner Information Form

| | |
|-----------|------------|
| Job Name: | Project #: |
|-----------|------------|

| |
|------------------------|
| Electrical Contractor: |
|------------------------|

NFPA requires this information for proper documentation

****The contractor MUST provide all of the information with an asterisk below before ANY equipment can be released.***

If building owner contact is unknown provide contact name/tel. of GC and check box

| | |
|-------------------------------------|-------------------------|
| Electrical Contractor Contact Name: | |
| Estimated Date Equip. Needed: | *Estimated Finals Date: |

| |
|------------------|
| *Building Owner: |
|------------------|

| |
|--------------------|
| *Job Site Address: |
|--------------------|

| | | |
|--------|--------|------|
| *City: | State: | Zip: |
|--------|--------|------|

| | |
|----------------|------------------|
| *Contact Name: | Check here if GC |
|----------------|------------------|

| | |
|-----------|--------|
| *Phone #: | Fax #: |
|-----------|--------|



PO Box 2551
2257 West Broadway
South Portland, ME 04106

1.800.370.3473
fax 207.879.0540

www.norrisinc.com

Thank you for your cooperation.

Please advise the building owners that if this system is equipped with a digital communicator, then they MUST also make monitoring arrangements prior to a certificate of occupancy. Norris Inc. will attempt to contact the building owners

STOP!

**THIS COPY IS FOR YOUR ELECTRICIAN
ON THE JOB-SITE**

PLEASE BE SURE THIS COPY IS FORWARDED

- 1) **A riser diagram is enclosed. DO NOT USE THE ENGINEER'S RISER SHOWN ON THE PLANS. If there is any information that you question, call us immediately.**
 - 2) **YOU MUST CALL AT LEAST FIVE DAYS IN ADVANCE TO SCHEDULE FINAL CONNECTION ASSISTANCE.**
 - 3) **All of your wires must be labeled and clear of any grounds, shorts or opens and must maintain polarity throughout. Meter out all circuits before calling for final connection assistance. If applicable verify End of Line resistors are in place.**
 - 4) **If using shielded cable, the drain wires must be connected and fully insulated (wrapped with tape) so that neither the shield or the drain wire touches the backbox.**
 - 5) **Unless special arrangements are made, we will make one final job-site visit. If a special visit is required for an elevator inspection or partial occupancy, then additional charges may apply if special arrangements were not made ahead. Call your customer service representative.**
 - 6) **If you have any defective or left-over parts DO NOT WRITE ON THEM OR THE BOXES. Save the original box, all mounting hardware and instructions. Returns that do not conform to this practice will not be accepted for credit.**
 - 7) **If the system is being monitored through a digital communicator, then please turn to page 2.**
-



PO Box 2551
2257 West Broadway
South Portland, ME 04106

1.800.370.3473
fax 207.879.0540

www.norrisinc.com

IMPORTANT INFORMATION FOR THE BUILDING OWNERS SPECIAL NOTE REGARDING ALARM MONITORING SERVICES

Included within your alarm system package is a digital communicator, which sends a coded message to a private 24-hour central station if your alarm system is activated. This is a code requirement for most fire alarm systems. As a service to our customer, we offer central station monitoring services from our local UL Listed central station at extremely competitive rates.

If the central station monitoring contract is purchased through Norris Inc. prior to our scheduled start-up; we will connect, program, and test the communicator at no additional charge.

Should the building owners decide to obtain monitoring services from another company, then the cost for programming and testing the communicator will be the sole responsibility of the firm they have contracted with. Furthermore, if programming changes are made to the system by persons other than Norris Inc. technicians, then the company performing the changes shall be solely liable for any personal injury or loss of life or damage to or loss of property arising out of the use of or inability to use the system and it shall result in a waiver of any system warranties.

We appreciate that you understand the delicate nature of this life safety and/or security system and realize that serious problems may arise when modifications to the system are made including very simple programming changes.

Call Norris Inc. at 1-800-370-FIRE (3473) to make arrangements for central station monitoring services.



PO Box 2551
2257 West Broadway
South Portland, ME 04106

1.800.370.3473
fax 207.879.0540

www.norrisinc.com

SUBMITTAL PACKAGE

Project: 125 Morning Street

System: Fire Alarm System

**Submitted
By:** Norris Inc.
2257 West Broadway
South Portland, Maine 04106
Telephone: (800) 370-3473

**Project
Manager:** Corey Chapman

**Electrical
Contractor:** Norris Inc.
2257 Broadway
South Portland, ME. 04106

Date: May 24, 2011

Company Profile

"We are extremely proud to represent the highest quality manufacturers integrating life safety, alarm and communication systems throughout northern New England."

-- Bradford Norris, President --

Mission Statement

Provide quality engineered systems, exceptional service.

Goal

Learn...Continually Improve...Exceed Expectations

Founded in 1979 Norris Inc. has grown to become Northern New England's leading integrated system contracting and supply company. Norris Inc. is an innovated proactive organization with extensive experience in integration interdisciplinary building management systems. Our local and national affiliations assure that your project will be done properly regardless of size representing leading manufacturers our comprehensive products provide outstanding quality reliability and performance... surpassing customer application requirements and exceeding the stringent requirements of Underwriters Laboratories, National Fire Protection Association and other codes. We maintain an exceptional level of quality and provide the highest levels of customer service. Our knowledgeable technical support will insure the great service you deserve. Whether your needs involve industrial, commercial, institutional, or educational applications, you can trust that Norris Inc. has the complete resources it takes to provide the right solution right away.

This
Certificate of Fitness

MASTER
Fire Alarm Installation and Servicing Company

is awarded to

NORRIS INC.

PO Box 2551 – 2257 West Broadway
S. Portland, ME 04106
(207)883-3473

CF # **M1008**



B. J. Wolf

Authority Having Jurisdiction

12/31/2011

Expiration Date

**THIS CERTIFICATE IS NOT AN ENDORSEMENT OF THIS COMPANY BY THE
AUTHORITY HAVING JURISDICTION.**

**TERMS AND CONDITIONS OF THIS CERTIFICATE OF FITNESS SHALL BE AS
FOLLOWS:**

**THIS CERTIFICATE REMAINS THE PROPERTY OF THE PORTLAND FIRE
DEPARTMENT AND SHALL BE RETURNED UPON DEMAND;**

THIS CERTIFICATE OF FITNESS IS NON-TRANSFERABLE;

**THIS CERTIFICATE OF FITNESS SHALL REMAIN IN EFFECT IN SO FAR AS THE
BEARER OF SAID INSTRUMENT SHALL COMPLY WITH RULES AND
REGULATIONS ESTABLISHED BY THE AUTHORITY HAVING JURISDICTION.**

**FAILURE TO COMPLY WITH ALL RULES AND REGULATIONS OF THE
AUTHORITY HAVING JURISDICTION WILL RESULT IN THE FOLLOWING:**

FIRST OFFENCE: PLAN OF ACTION TO ADDRESS DEFICIENCIES

SECOND OFFENCE: PROBATION OF SERVICE COMPANY

THIRD OFFENCE: TERMINATION OF CERTIFICATE OF FITNESS

City of Portland/Portland Police Department
Alarm Business/Agent Permit

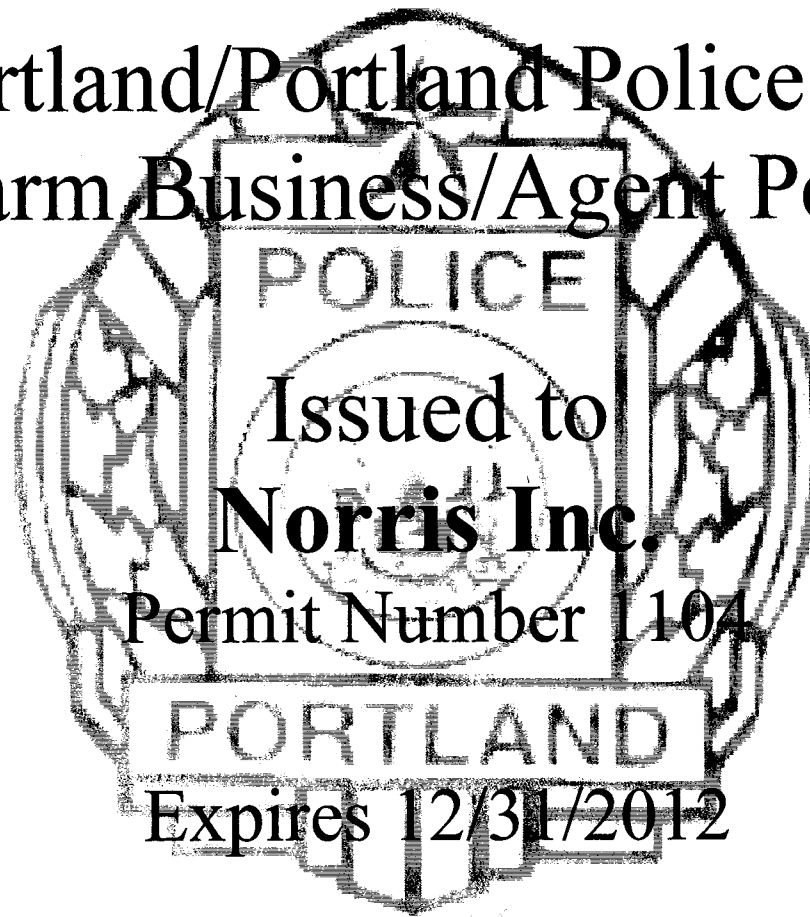

Permit Number 1104

PORTLAND

Expires 12/31/2012



Underwriters Laboratories Inc.®

Northbrook, IL San Jose, CA
Melville, NY

A not-for-profit organization dedicated to public safety
and committed to quality service

Applicant ID No: **762075-001**
Service Center No **0**
Expires: **31-MAR-2011**

CERTIFICATE OF COMPLIANCE

THIS IS TO CERTIFY that the Alarm Service Company indicated below is included by Underwriters Laboratories Inc. (UL) in its Product Directories as eligible to use the UL Listing Mark in connection with Certificated Alarm Systems. The only evidence of compliance with UL's requirements is the issuance of a UL Certificate for the Alarm System and the Certificate is current under UL's Certificate Verification Service. This Certificate does not apply in any way to the communication channel between the protected property and any facility that monitors signals from the protected property unless the use of a UL listed or Classified Alarm Transport Company is specified on the Certificate.

Listed Service From: **STOWE, VT**

Alarm Service Company: (762075-001)

HOME SECURITY & MANAGEMENT CO INC
57 CENTRAL DR
PO BOX 695
STOWE VT 05672

Service Center: (762075-001)

HOME SECURITY & MANAGEMENT CO INC
57 CENTRAL DR
PO BOX 695
STOWE VT 05672

The Alarm Service Company is Listed in the following Certificate Service Categories:

File - Vol No. CCN Listing Category

S6427 - 1 UUFX [Signal and Fire Alarm Equipment and Services] (Protective Signaling Services) Central Station

*****THIS CERTIFICATE EXPIRES ON 31-MAR-2011 *****

"LOOK FOR THE UL ALARM SYSTEM CERTIFICATE"

Engineering Manager
08-MAR-2010



CERTIFICATE *of* MEMBERSHIP

Norris Inc

is a member in good standing entitled to all rights and privileges of membership and subject to all conditions and objectives as defined in the association bylaws, code of ethics and standards of conduct.

A handwritten signature in black ink, appearing to read "Merlin J. Guilbeau".

MERLIN J. GUILBEAU
EXECUTIVE DIRECTOR

A handwritten signature in black ink, appearing to read "Charles D. D'Ascoli".

CHARLES "DOM" D'ASCOLI
PRESIDENT

2011

 **NOTIFIER**[®]
by Honeywell

This is to certify that

NORRIS, INC.

is an authorized Engineered Systems Distributor for NOTIFIER

During the year of 2010



Signed for and on behalf of NOTIFIER

Vice President Domestic Sales

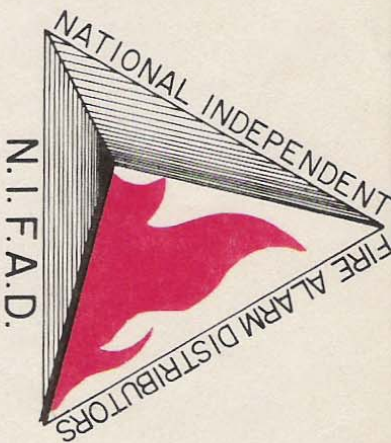

National Independent Fire Alarm Distributors Association

This is to Certify that

Morris Inc.

is a

Member in Good Standing

and is entitled to all rights and privileges of such membership

David Pomeroy

Secretary

Edgar Smith

President



DSX Access Systems, Inc.



AUTHORIZED & FACTORY TRAINED DEALER

Norris, Inc.
of
South Portland, ME.

Is an Authorized and Factory Trained Dealer
of DSX Access Control Systems.

President: Bart Holzer

Quality. Reliability. Integrity. The Security Professional's First Choice.

NATIONAL SYSTEMS CONTRACTORS ASSOCIATION

NSCA Membership Certificate

This is to certify that

Norris Inc

is an official member of the

National Systems Contractors Association

on this the

First of December

Andrew M. Musci

Andrew M. Musci
President

Chuck R. Wilson

Chuck Wilson
Executive Director

NATIONAL INSTITUTE FOR CERTIFICATION IN ENGINEERING TECHNOLOGIES®

HEREBY CERTIFIES THAT
David S. Gagnon

HAS ATTAINED THE GRADE OF
LEVEL IV

IN FIRE PROTECTION ENGINEERING TECHNOLOGY
FIRE ALARM SYSTEMS

AND RECOGNIZES THAT THROUGH EDUCATION,
EXPERIENCE, AND KNOWLEDGE THIS PERSON HAS
MET THE STANDARDS SET FORTH BY THIS INSTITUTE

Certification Valid through April 1, 2011

CERTIFICATION NUMBER 88203

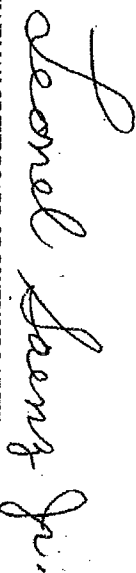
CHAMAN OF THE BOARD OF GOVERNORS, NICET

SPONSORED BY THE NATIONAL SOCIETY OF PROFESSIONAL ENGINEERS

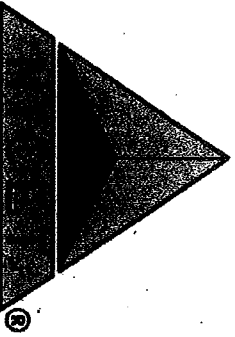

Norris Inc
2257 West Broadway
South Portland, ME 04106
1-800-370-3473

309605R1
Equipment List :

Trevor Coyne

125 Morning St.

Description

NOTIFIER-NFW-50, Addressable FACP, Black
ADI-IM-1270, 12V 7AMP Battery
NOTIFIER-N-ANN-80, Remote LCD annunciator, Black
NOTIFIER-NP-100, Intelligent Addressable Photo detector (above panel per code)
SPAAGEELE-SSU00685, Fire Alarm Records Storage Cabinet
SPAAGEELE-IE0091, Notifier Lock
SPECIAL-KNOXR, Knox Box
SPECIAL-KNOXR-SURFACE, Surface Mount Knox Box
SPECIAL-KNOXR-LIFTCOVER, Lift Cover for Knox Box
SPECIAL-KNOXR-BLACK, Black Knox Box Color
NOTIFIER-NOT-BG12LX, Addressable Pull Station
NOTIFIER-MIZ-24S-W, Mini Horn, Wall, White
NOTIFIER-HSW, Horn Strobe, Wall, White
NOTIFIER-NH-100, Intelligent Addressable Thermal detector w/ base.
NOTIFIER-5601P, Conventional Heat Detector
NOTIFIER-NMM-100, Addressable Monitor Module
NOTIFIER-NP-100, Intelligent Addressable Photo detector, with base.

→ FireWarden-50(E)

Intelligent Addressable FACP with Built-In Communicator



Addressable Fire Alarm Control Panels

General

The NOTIFIER FireWarden-50 (NFW-50) is a Fire Alarm Control Panel (FACP) and Digital Alarm Communicator/Transmitter (DACT) combined into one circuit board. This compact, intelligent addressable control panel supports up to 50 addressable devices in any combination of detectors or modules. With an extensive list of powerful features, the FireWarden-50 programs just like FireWarden-100 products, yet fits into applications previously served only by conventional panels.

The FireWarden-50's integral DACT transmits system status (alarms, troubles, AC loss, etc.) to a Central Station via the public switched telephone network. It also allows remote and local programming of the control panel using the PS-Tools Upload/Download utility. In addition, the control panel may be programmed or interrogated off-site via the public switched telephone network. Any personal computer with Windows™ 95 or greater, and compatible modem with a speed of 14.4 kbps or faster and Upload/Download software, may serve as a Service Terminal. This allows download of the entire program or upload of the entire program, history file, walk-test data, current status and system voltages.

The power supply and all electronics are contained on a single circuit board supported on a new quick install chassis and housed in a metal cabinet. Available accessories include local and remote upload/download software, remote annunciators, and reverse polarity/city box transmitter. (4XTM)

The FireWatch Series internet monitoring modules IPDACT-2 and IPDACT-2UD permit monitoring of alarm signals over the Internet, saving the monthly cost of two telephone lines. Although not required, the secondary telephone line may be retained providing backup communication over the public switched telephone line.

NOTE: Unless otherwise specified, the term FireWarden-50 is used in this data sheet to refer to both the FireWarden-50 and the FireWarden-50E FACPs. For FireWarden-50C, refer to DN-60446.

Features

- Listed to UL Standard 864, 9th edition.
- Auto-program (learn mode) reduces installation time. Reports two devices set to the same address.
- On-board DACT.
- Two independently programmable Style Z (Class A) or Style Y (Class B) NAC circuits.
- Selectable strobe synchronization for System Sensor, Wheelock, and Gentex devices.
- Remote Acknowledge, Silence, Reset and Drill via addressable monitor modules.
- Two programmable relays and one fixed trouble relay.
- Built-in Programmer.
- Telephone Line Active LEDs.
- EIA-232 PC interface.
- Integral 80-character LCD display with backlighting.
- Real-time clock/calendar with automatic daylight savings control.
- History file with 500 event capacity.
- Automatic detector sensitivity testing (NFPA 72 compliant).
- Automatic device type-code verification.



- Point trouble identification.
- Waterflow selection per module point.
- Alarm verification selection per detector point.
- Maintenance alert warns when smoke detector dust accumulation is excessive.
- One-person audible or silent walk test with walk-test log and printout.
- System alarm verification selection per detector point.
- PAS (Positive Alarm Sequence) and Pre-signal per point (NFPA 72 compliant).
- Up to eight ANN-BUS annunciators
- Remote Acknowledge, Alarm Silence, Reset and Drill via addressable modules or remote annunciator.
- Upload/Download (local or remote) of program and data via integral DACT.

SLC COMMUNICATION LOOP

- Single addressable SLC loop which meets NFPA Style 4, 6 and 7 requirements.
- 50 addressable device capacity (any combination of addressable detectors and modules).
- Compatible with NOTIFIER FireWarden addressable devices (refer to the *FireWarden SLC Wiring Manual*).

NOTIFICATION APPLIANCE CIRCUITS (NACS)

- Two independently programmable output circuits. Circuits can be configured for the following outputs:
 - **Style Y** (Class B)
 - **Style Z** (Class A)
 - **Door Holder Service** (cannot be used for notification appliances)
 - **Aux Power Source** (cannot be used for notification appliances)
- Silence Inhibit and Autosilence timer options.
- Continuous, March Time, Temporal or California code for main circuit board NACs with two-stage capability.
- Selectable strobe synchronization per NAC.
- 2.5 A total power for NACs.

NOTE: Maximum or total 24VDC system power shared between all NAC circuits and the ANN-BUS is 2.7 A.

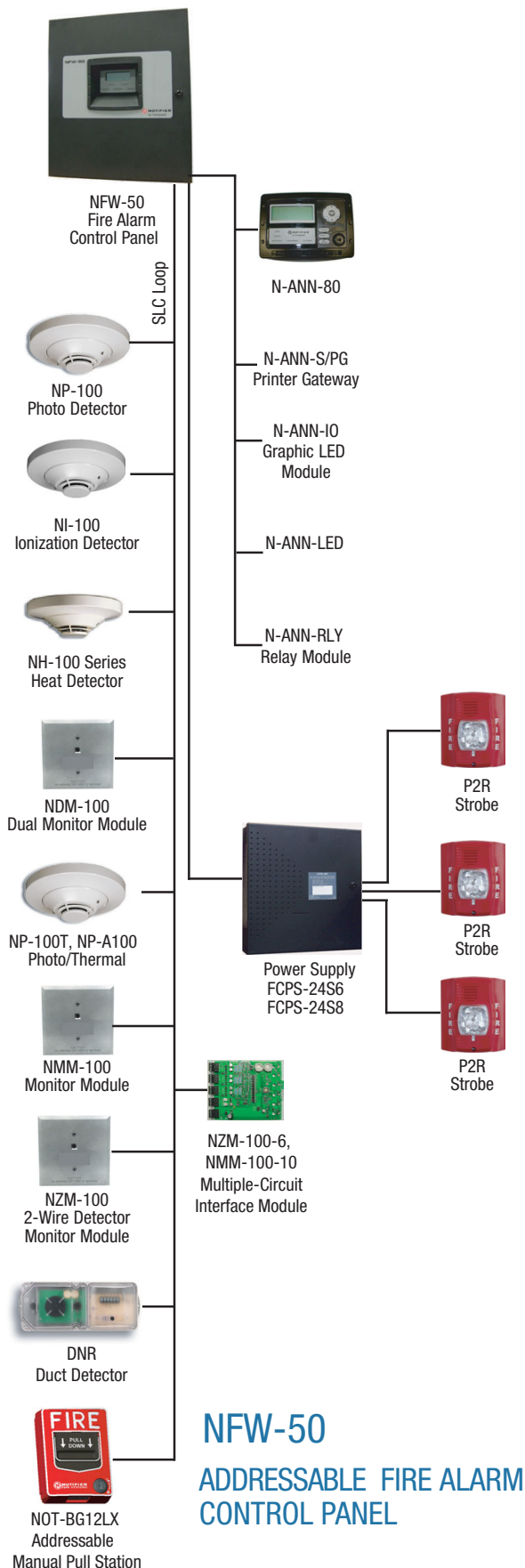

PROGRAMMING AND SOFTWARE

- Autoprogram (learn mode) reduces installation time.
- Custom English labels (per point) may be manually entered or selected from an internal library file.
- Two programmable Form-C relay outputs.
- 20 software zones.
- Continuous fire protection during online programming at the front panel.
- Program Check automatically catches common errors not linked to any zone or input point.
- **OFFLINE PROGRAMMING:** Create the entire program in your office using PS-Tools, Windows®-based software package, and upload/download system programming locally. PS-Tools is available on www.magni-fire.com.

User interface

LED INDICATORS

- AC Power (green)
- Fire Alarm (red)
- Supervisory (yellow)
- Trouble (yellow)
- Alarm Silenced signals (yellow)

KEYPAD

- 16 key alpha-numeric pad
- Acknowledge/Step
- Alarm Silenced
- Drill (Manual Evacuate)
- Reset (lamp test)

Product Line Information

NFW-50: Combination DACT/Fire Alarm Control Panel with one SLC loop. Includes main circuit board with display, chassis with transformer, backbox with door, plastic bag containing screws, cables, key, etc., manual. (For NFW-50C, refer to DN-60446.)

NFW-50E: Same as NFW-50, but operates at 240 VAC.

NFW-50R: Same as NFW-50, with red backbox and door.

DP-51050B: Optional dress panel for NFW-50 (black).

DP-51050: Optional dress panel for the NFW-50R (red).

TR-CE-B: Optional trim ring for semi-flush mounting. (Black. For red, order **TR-CE**.)

BB-XP: Optional cabinet for one or two modules.

BB-25: Optional cabinet for up to six modules mounted on CHS-6 chassis.

BB-26: Battery backbox, holds up to two 25 AH batteries and CHG-75.

NFS-LBB: Battery box, houses two 55 AH batteries

CHS-6: Chassis, mounts up to six multi-modules in a BB-25 cabinet.

CHG-75: Battery charger for lead-acid batteries with a rating of 25 to 75 AH.

CHG-120: Remote battery charging system for lead-acid batteries with a rating of 55 to 120 AH. Requires additional NFS-LBB for mounting.

NOTE: CHG-120 or CHG-75 required for batteries larger than 18AH.

BAT Series: Batteries, see data sheet DN-6933.

PRT/PK-CABLE: Cable printer/personal computer interface cable.

PRN-6: UL listed compatible event printer. Uses tractor-fed paper.

IPDACT, IPDACT-2/2UD Internet Monitoring Module: Mounts in bottom of enclosure with optional mounting kit (PN IPBRKT). Connects to primary and secondary DACT telephone output ports for internet communications over customer provided ethernet internet connection. Requires compatible Teldat Visoralarm Central Station Receiver. Can use DHCP or static IP. (See data sheet dn-60408 for more information.)

IPBRKT: Mounting kit for IPDACT-2/2UD in common enclosure.

IPSPLT: Y-adaptor option allows connection of both panel dialer outputs to one IPDACT-2/2UD cable input.

AC-TRMBLK: AC Terminal Block mounts to a metal bracket, in turn, mounts to the FACP chassis. Use AC-TRMBLK when wire nuts are not allowed for AC connections to the transformer.

OPTIONAL MODULES

4XTM Reverse Polarity Transmitter Module: Provides a supervised output for local energy municipal box transmitter, alarm and trouble. Includes a disable switch and disable trouble LED.

ANN-SEC: Optional secondary ANN-BUS interface module. Note: Used only with firmware 3.0 or higher.

COMPATIBLE ANNUNCIATORS

N-ANN-80(-W): Remote LCD annunciator mimics the information displayed on the FACP LCD display. Recommended wire type is un-shielded. (Basic model is black; order -W for white; see DN-7114.)

N-ANN-I/O: LED Driver Module provides connections to a user supplied graphic annunciator. (See DN-7105.)

N-ANN-LED: Annunciator Module provides three LEDs for each zone: Alarm, Trouble, and Supervisory. Ships with red enclosure. (See DN-60242.)

N-ANN-RLED: Provides alarm (red) indicators for up to 30 input zones or addressable points. (See DN-60242.)

N-ANN-RLY: Relay Module provides 10 programmable Form-C relays. Can be mounted inside the cabinet. (See DN-7107.)

N-ANN-S/PG: Serial/Parallel Printer Gateway module provides a connection for a serial or parallel printer. (See DN-7103.)

ADDRESSABLE DEVICES

All feature a polling LED and rotary switches for addressing.

NI-100: Addressable low-profile ionization smoke detector.

NP-100: Addressable low-profile photoelectric smoke detector.

NP-100T: Addressable low-profile photoelectric smoke detector with thermal sensor.

NP-100R: Remote test capable addressable photoelectric smoke detector for use with DNR(W) duct detector housing.

NH-100: Fast-response, low-profile heat detector.

NH-100R: Fast-response, low-profile heat detector with rate-of-rise option.

NH-100H: Fast-response, low-profile heat detector that activates at 190°F/88°C.

NP-A100: Addressable low-profile multi-sensor detector.

DNR: InnovairFlex low-flow non-relay duct-detector housing. (Order NP-100R separately.)

DNRW: InnovairFlex low-flow non-relay duct-detector housing, with NEMA-4 rating. Watertight. (Order NP-100R separately.)

NMM-100: Addressable Monitor Module for one zone of normally-open dry-contact initiating devices. Mounts in standard 4.0" (10.16 cm.) box. Includes plastic cover plate and end-of-line resistor. Module may be configured for either a Style B (Class B) or Style D (Class A) IDC.

NDM-100: Dual Monitor Module. Same as NMM-100 except it provides two Style B (Class B) only IDCs.

NMM-100P: Miniature version of NMM-100. Excludes LED and Style D option. Connects with wire pigtails. May mount in device backbox.

NZM-100A: Similar to NMM-100A. Addressable Monitor Module for one zone of conventional two-wire detectors. Requires resettable 24 VDC power. Refer to the *Device Compatibility Document* for listed compatible devices and quantity limitation.

NZM-100-6: Six-zone interface module. Mount one or two modules in a BB-XP cabinet (optional). Mount up to six modules on a CHS-6 chassis in a BB-25 cabinet.

NMM-100-10: Ten-input monitor module. Mount one or two modules in a BB-2 cabinet (optional). Mount up to six modules on a CHS-6 chassis in a BB-25 cabinet.

NC-100: Addressable Control Module for one Style Y/Z (Class B/A) zone of supervised polarized Notification Appliances. Mounts directly to a 4.0" (10.16 cm.) electrical box. Notification Appliance Circuit option requires external 24 VDC to power notification appliances.

NC-100R: Addressable relay module containing two isolated sets of Form-C contacts, which operate as a DPDT switch. Mounts directly to a 4.0" (10.16 cm.) box, surface mount using the SMB500.

NOT-BG12LX: Addressable manual pull station with interface module mounted inside.

N100-ISO: Fault Isolator Module.

SMB500: Used to mount all modules except the NMM-100P.

NOTE: For more information on Compatible Addressable Devices for use with the FireWarden-50, see the following data sheets (document numbers): N100-ISO (DN-6994), NP-100 series (DN-6995), NI-100 (DN-6996), NH-100/NH-100R (DN-6997), DNR/InnovairFlex (DN-60424, DN-60429), NP-A100 (DN-6998), NMM-100/NMM-100P/NDM-100/NZM-100 (DN-6999), NC-100 (DN-7000), NC-100R (DN-60383), NMM-100-10 (DN-6990), and NOT-BG12LX (DN-7001).

ADDRESSABLE DEVICE ACCESSORIES

End-of-Line Resistor Assembly (R-47K and R-3.9K): The 47k ohm assembly supervises the NMM-100-10, NDM-100, NMM-100P, and NC-100 module circuits. The 3.9k ohm assembly supervises the NZM-100-6 module circuit. These resistors are included with each module.

Power Supervision Relay: Supervises the power to 4-wire smoke detectors and notification appliances.

Wiring Requirements

While shielded wire is not required, it is recommended that all SLC wiring be twisted-pair to minimize the effects of electrical interference. Refer to the panel manual for wiring details.

SYSTEM SPECIFICATIONS

System Capacity

- Intelligent Signalling Line Circuits..... 1
- Addressable device capacity 50
- Programmable software zones 20
- Annunciators 8

Electrical Specifications

AC Power: FireWarden-50: 120 VAC, 60 Hz, 3.0 A. FireWarden-50E: 240 VAC, 50 Hz, 1.5 A. Wire size: minimum 14 AWG (2.00 mm²) with 600 V insulation. Nonpower-limited, supervised.

Battery: Two 12 V 18 AH lead-acid batteries. Battery Charger Capacity: 7-18 AH (FireWarden-50 cabinet holds maximum of two 18 AH batteries.)

Communication Loop: Supervised and power-limited.

Notification Appliance Circuits: Terminal Block provides connections for two NACs, Style Y (Class B) or Style Z (Class A). Special Application power. Power-limited, supervised circuitry. Maximum signaling current per circuit: 2.5 A. End-of-Line Resistor: 4.7k ohm, ½ watt (P/N 71252 UL listed) for Style Y (Class B) NAC. Refer to the *NOTIFIER Device Compatibility Document* for listed compatible devices.

Two Programmable Relays and One Fixed Trouble Relay: Contact rating: 2.0 A @ 30 VDC (resistive), 0.5 A @ 30 VAC (resistive). Form-C relays, nonpower-limited, nonsupervised.

Cabinet Specifications

Door: 19.26" (48.92 cm.) high x 16.82" (42.73 cm.) wide x 0.72" (1.82 cm.) deep. **Backbox:** 19.00" (48.26 cm.) high x 16.65" (42.29 cm.) wide x 5.25" (13.34 cm.) deep. **Trim Ring (TR-CE/B):** 22.00" (55.88 cm.) high x 19.65" (49.91 cm.) wide.

Shipping Specifications

Weight: 26.9 lbs. (12.20 kg.) **Dimensions:** 20.00" (50.80 cm.) high x 22.5" (57.15 cm.) wide x 8.5" (21.59 cm.) deep.

Temperature and Humidity Ranges

This system meets NFPA requirements for operation at 0 – 49°C/32 – 120°F and at a relative humidity 93% ± 2% RH

(noncondensing) at 32°C ± 2°C (90°F ± 3°F). However, the useful life of the system's standby batteries and the electronic components may be adversely affected by extreme temperature ranges and humidity. Therefore, it is recommended that this system and its peripherals be installed in an environment with a normal room temperature of 15 – 27°C/60 – 80°F.

NFPA Standards

The FireWarden-50 complies with the following NFPA 72 Fire Alarm Systems requirements:

- **LOCAL** (Automatic, Manual, Waterflow and Sprinkler Supervisory).
- **AUXILIARY** (Automatic, Manual and Waterflow) (requires 4XTM).
- **REMOTE STATION** (Automatic, Manual and Waterflow) (Where a DACT is not accepted, the alarm, trouble and supervisory relays may be connected to UL 864 listed transmitters. For reverse polarity signaling of alarm and trouble, 4XTM is required.)
- **PROPRIETARY** (Automatic, Manual and Waterflow).
- **CENTRAL STATION** (Automatic, Manual and Waterflow, and Sprinkler Supervised).
- **OT, PSDN** (Other Technologies, Packet-switched Data Network)

Agency Listings and Approvals

The listings and approvals below apply to the basic FireWarden-50 control panel. In some cases, certain modules may not be listed by certain approval agencies, or listing may be in process. Consult factory for latest listing status.

- **UL:** S635
- **FM approved**
- **CSFM:** 7165-0028:239
- **MEA:** 442-06-E Vol. 2

NOTE: See DN-60446 for ULC-listed model.

NOTIFIER®, FireWarden®, and System Sensor® are registered trademarks of Honeywell International Inc. Microsoft® and Windows® are registered trademarks of the Microsoft Corporation. ©2011 by Honeywell International Inc. All rights reserved. Unauthorized use of this document is strictly prohibited.



This document is not intended to be used for installation purposes. We try to keep our product information up-to-date and accurate. We cannot cover all specific applications or anticipate all requirements. All specifications are subject to change without notice.



Made in the U.S.A.

For more information, contact Notifier. Phone: (203) 484-7161, FAX: (203) 484-7118. www.notifier.com

→ BAT Series Batteries

Sealed Lead-Acid or Gell Cell



Power Supplies

General

BAT Series Batteries feature a new part-numbering/listing system — providing an improved method of delivery for NOTIFIER-approved sealed lead-acid batteries for all your fire alarm system needs. Multiple brands of batteries are now offered under generic part numbers, reducing backorder situations and permitting us to deliver these products in a more timely fashion. NOTIFIER has approved the multiple brands listed below as possible product shipped for a given part number. Please note that any incoming orders for “PS Series” batteries will be converted to the equivalent BAT Series part numbers.



6933cov.jpg

Features

- Provide secondary power for control panels.
- Sealed and maintenance-free.
- Overcharge protected.
- Easy handling with leakproof construction.
- Ruggedly constructed, high-impact case (ABS, polystyrene, or polypropylene, depending on models).
- Long service life.
- Compact design.

Agency Listings and Approvals

The listings and approvals below apply to BAT Series Batteries. In some cases, certain modules may not be listed by certain approval agencies, or listing may be in process. Consult factory for latest listing status.

- **UL Recognized Components:** files MH19884 (*B & B Battery*), MH20567 (*UPG, previously Jolt*), MH20845 (*Power-Sonic*).

Part Number Reference

| CURRENT Part Number | BATTERY DESCRIPTION | ALTERNATES APPROVED: manufacturers and P/Ns shipped under BAT P/Ns |
|---------------------|--------------------------|--|
| BAT-1250 | 12 V, 5 AH, sealed. | BP5-12 (B&B Battery); PS-1250 (Power-Sonic); SA1250 (Jolt) to be replaced with UB1250 (UPG). |
| BAT-1250 | 12 V, 5 AH, sealed. | BP5-12 (B&B Battery); PS-1250 (Power-Sonic); SA1250 (Jolt) to be replaced with UB1250 (UPG). |
| → BAT-1270 | 12 V, 7 AH, sealed. | BP7-12 (B&B Battery); PS-1270 (Power-Sonic); SA1272 (Jolt) to be replaced with UB1270 (UPG). |
| BAT-12120 | 12 V, 12 AH, sealed. | BP12-12 (B&B Battery); PS-12120 (Power-Sonic); SA12120 (Jolt) to be replaced with UB12120 (UPG). |
| BAT-12180 | 12 V, 18 AH, sealed. | PS-12180 (Power-Sonic); SA12180 (Jolt) to be replaced with UB12180 (UPG). |
| BAT-12180 | 12 V, 18 AH, sealed. | PS-12180 (Power-Sonic); SA12180 (Jolt) to be replaced with UB12180 (UPG). |
| BAT-12260 | 12 V, 26 AH, sealed. | BP26-12 (B&B Battery); PS-12260 (Power-Sonic); SA12260 (Jolt) to be replaced with UB12260 (UPG). |
| BAT-12550 | 12 V, 55 AH, sealed. | PS-12550 (Power-Sonic); XSA12550 (Jolt) to be replaced with UB12550 (UPG). |
| BAT-12550 | 12 V, 55 AH, sealed. | PS-12550 (Power-Sonic); XSA12550 (Jolt) to be replaced with UB12550 (UPG). |
| BAT-121000 | 12 V, 100 AH, gell cell. | PS-121000 (Power-Sonic); XSA121000A (Jolt) to be replaced with UB121000 (UPG). |

POWER-SONIC

Part Number Reference

1109t1.tbl

| MODEL | Nominal Voltage V | Nominal Capacity @ 20 hr. rate A.H. | Discharge Current @20 hr. rate mA | DIMENSIONS | | | | | | | | | |
|-----------|-------------------|-------------------------------------|-----------------------------------|------------|-----|-------|-----|--------|-----|----------------------|-----|--------|------|
| | | | | Width | | Depth | | Height | | Height over terminal | | Weight | |
| | | | | in. | mm | in. | mm | in. | mm | in. | mm | lb. | kg. |
| PS-1250 | 12 | 5 | 250 | 3.54 | 90 | 2.76 | 70 | 4.02 | 102 | 4.21 | 107 | 4.1 | 1.9 |
| PS-1270 | 12 | 7 | 325 | 5.94 | 151 | 2.56 | 65 | 3.7 | 94 | 3.86 | 98 | 5.7 | 2.6 |
| PS-12120 | 12 | 12 | 600 | 5.94 | 151 | 3.86 | 98 | 3.7 | 94 | 3.86 | 98 | 8.8 | 4 |
| PS-12180 | 12 | 18 | 875 | 7.13 | 181 | 2.99 | 76 | 6.57 | 167 | 6.57 | 167 | 12.8 | 5.8 |
| PS-12250 | 12 | 25 | 1300 | 6.89 | 175 | 6.54 | 166 | 4.92 | 125 | 4.92 | 125 | 18.7 | 8.5 |
| PS-12550 | 12 | 55 | 3000 | 10.25 | 260 | 6.6 | 168 | 8.2 | 208 | 9.45 | 240 | 39.7 | 18 |
| PS-121000 | 12 | 100 | 5000 | 12 | 305 | 6.6 | 168 | 8.2 | 208 | 9.45 | 240 | 65.7 | 29.8 |

Characteristic Discharge Curves

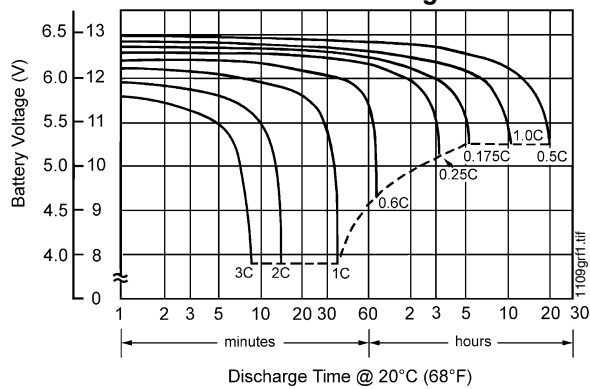

Effect of Temperature on Capacity

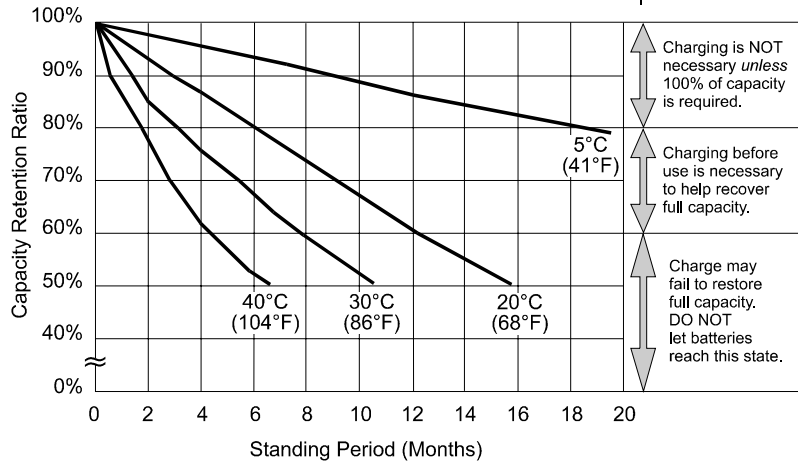
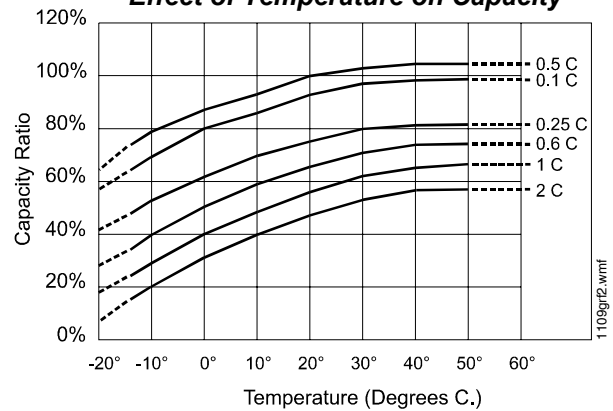

**at left:
PS-121000
Shelf-Life
and Storage**

Charging is NOT necessary unless 100% of capacity is required.
Charging before use is necessary to help recover full capacity.
Charge may fail to restore full capacity. DO NOT let batteries reach this state.

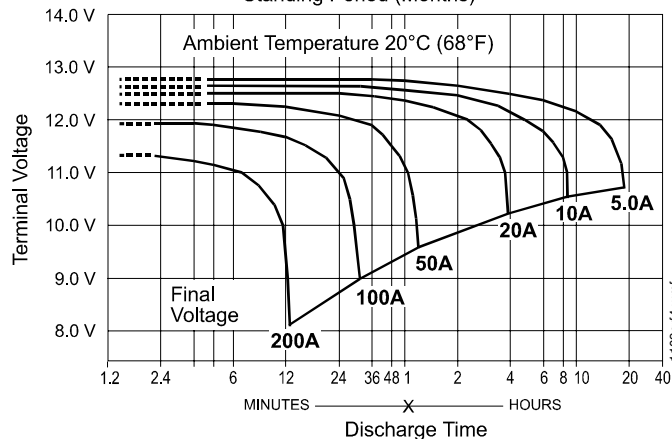

**at left:
PS-121000
Discharge
Characteristics**

B & B BATTERY

| Model | V | Nominal Capacity (AH) | | | | Weight | | Terminal | | | | Dimensions | | | | | | | |
|---------|----|-----------------------|-------|-------|-------|--------|-------|----------|------|----------|------|------------|------|-----|------|-----|------|-----|------|
| | | | | | | | | Standard | | Optional | | L | | W | | H | | TH | |
| | | 20 hr | 10 hr | 5 hr | 1 hr | kg | lbs | Type | Pos. | Type | Pos. | mm | in | mm | in | mm | in | mm | in |
| BP5-12 | 12 | 5.00 | 4.75 | 4.25 | 3.00 | 1.86 | 4.10 | T1 | 3 | T2 | | 90 | 3.54 | 70 | 2.76 | 102 | 4.02 | 106 | 4.17 |
| BP7-12 | 12 | 7.00 | 6.65 | 5.95 | 4.20 | 2.60 | 5.73 | T2 | 5 | T1 | | 151 | 5.94 | 65 | 2.56 | 93 | 3.66 | 98 | 3.86 |
| BP12-12 | 12 | 12.00 | 11.40 | 10.20 | 7.20 | 4.03 | 8.89 | B1 | 5 | T1 | | 151 | 5.94 | 98 | 3.86 | 94 | 3.70 | 98 | 3.86 |
| BP26-12 | 12 | 26.00 | 24.70 | 22.10 | 15.60 | 9.40 | 20.73 | B1 | 7 | T2.11 | 9 | 175 | 6.89 | 166 | 6.54 | 125 | 4.92 | 125 | 4.92 |

Charging Procedure

| Application | Charging method | Charging voltage at 20°C (V/cell) | Temperature compensation coefficient of charging voltage (mV/°C/cell) | Maximum charging current (CA) | Charging time 0.1 CA, 20°C (h) | | Temp (°C) |
|--------------------------|---|-----------------------------------|---|-------------------------------|--------------------------------|---------------|--------------------------|
| | | | | | 100% discharge | 50% discharge | |
| For standby power source | Constant voltage and constant current charging (with current restriction) | 2.25 ~ 2.30 | - 3 | 0.3 | 24 | 20 | 0 - 40°C (32 ~ 104°F) |
| For cycle service | | 2.40 ~ 2.50 | - 4 | 0.3 | 16 | 10 | |

Temperature compensation of charging voltage is not needed when using the batteries within 5°C to 35°C range.

| Final Voltage | Discharge Time: for Model BP5-12 | | | | | | | | |
|---------------|--|--------|--------|--------|-------|-------|-------|-------|-------|
| | 5 min | 10 min | 15 min | 30 min | 1 hr | 3 hr | 5 hr | 10 hr | 20 hr |
| | Battery Output Power (W): for Model BP5-12 | | | | | | | | |
| 10.80 V | 180.8 | 133.1 | 106.6 | 63.5 | 36.39 | 14.57 | 10.05 | 5.62 | 2.94 |
| 10.50 V | 209.2 | 144.2 | 111.5 | 65.9 | 37.48 | 14.87 | 10.20 | 5.70 | 3.00 |
| 10.20 V | 222.3 | 149.4 | 115.0 | 67.4 | 38.16 | 15.00 | 10.26 | 5.73 | 3.01 |
| 9.90 V | 232.3 | 152.9 | 117.6 | 68.3 | 38.61 | 15.10 | 10.29 | 5.75 | 3.02 |
| 9.60 V | 240.0 | 156.0 | 120.0 | 69.0 | 39.0 | 15.20 | 10.32 | 5.75 | 3.02 |

Constant Power Discharge Characteristics at 25°C/77°F for BP5-12

| Final Voltage | Discharge Time: for Model BP7-12 | | | | | | | | |
|---------------|--|--------|--------|--------|-------|-------|-------|-------|-------|
| | 5 min | 10 min | 15 min | 30 min | 1 hr | 3 hr | 5 hr | 10 hr | 20 hr |
| | Battery Output Power (W): for Model BP7-12 | | | | | | | | |
| 10.80 V | 253.1 | 186.3 | 149.3 | 88.8 | 50.95 | 20.40 | 14.07 | 7.86 | 4.11 |
| 10.50 V | 292.9 | 201.8 | 156.2 | 92.2 | 52.47 | 20.81 | 14.28 | 7.98 | 4.20 |
| 10.20 V | 311.2 | 209.1 | 161.0 | 94.3 | 53.42 | 21.00 | 14.36 | 8.02 | 4.22 |
| 9.90 V | 325.2 | 214.1 | 164.7 | 95.6 | 54.06 | 21.15 | 14.41 | 8.04 | 4.23 |
| 9.60 V | 336.0 | 218.4 | 168.0 | 96.6 | 54.60 | 21.27 | 14.45 | 8.04 | 4.23 |

Constant Power Discharge Characteristics at 25°C/77°F for BP7-12

| Final Voltage | Discharge Time: for Model BP12-12 | | | | | | | | |
|---------------|---|--------|--------|--------|-------|-------|-------|-------|-------|
| | 5 min | 10 min | 15 min | 30 min | 1 hr | 3 hr | 5 hr | 10 hr | 20 hr |
| | Battery Output Power (W): for Model BP12-12 | | | | | | | | |
| 10.80 V | 433.9 | 319.4 | 256.0 | 152.3 | 87.34 | 34.98 | 24.12 | 13.48 | 7.05 |
| 10.50 V | 502.2 | 346.0 | 267.7 | 158.1 | 89.96 | 35.68 | 24.48 | 13.68 | 7.20 |
| 10.20 V | 533.6 | 358.5 | 276.0 | 161.7 | 91.57 | 36.00 | 24.61 | 13.75 | 7.23 |
| 9.90 V | 557.5 | 367.1 | 282.4 | 164.0 | 92.67 | 36.25 | 24.70 | 13.79 | 7.25 |
| 9.60 V | 576.0 | 374.4 | 288.0 | 165.6 | 93.60 | 36.47 | 24.77 | 13.79 | 7.25 |

Constant Power Discharge Characteristics at 25°C/77°F for BP12-12

| Final Voltage | Discharge Time: for Model BP26-12 | | | | | | | | |
|---------------|---|--------|--------|--------|--------|-------|-------|-------|-------|
| | 5 min | 10 min | 15 min | 30 min | 1 hr | 3 hr | 5 hr | 10 hr | 20 hr |
| | Battery Output Power (W): for Model BP26-12 | | | | | | | | |
| 10.80 V | 940.0 | 692.0 | 554.6 | 330.0 | 189.23 | 75.79 | 52.25 | 29.20 | 15.26 |
| 10.50 V | 1088.0 | 749.7 | 580.0 | 342.5 | 194.91 | 77.30 | 53.04 | 29.64 | 15.60 |
| 10.20 V | 1156.0 | 776.7 | 598.0 | 350.3 | 198.41 | 78.00 | 53.33 | 29.79 | 15.67 |
| 9.90 V | 1208.0 | 795.3 | 611.8 | 355.2 | 200.79 | 78.54 | 53.52 | 29.88 | 15.71 |
| 9.60 V | 1248.0 | 811.2 | 624.0 | 358.8 | 202.80 | 79.01 | 53.68 | 29.88 | 15.71 |

Constant Power Discharge Characteristics at 25°C/77°F for BP26-12

B & B BATTERY

BP5-12 Battery Discharge Characteristics (25°C/77°F)

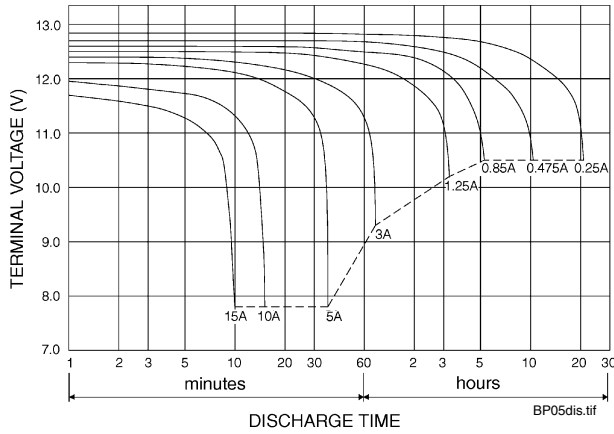

BP7-12 Battery Discharge Characteristics (25°C/77°F)

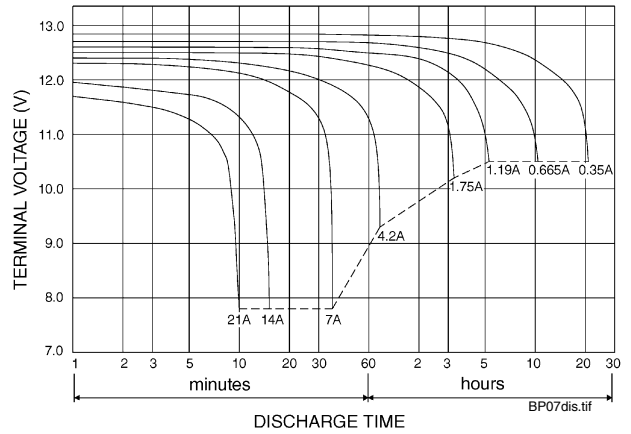

BP12-12 Battery Discharge Characteristics (25°C/77°F)

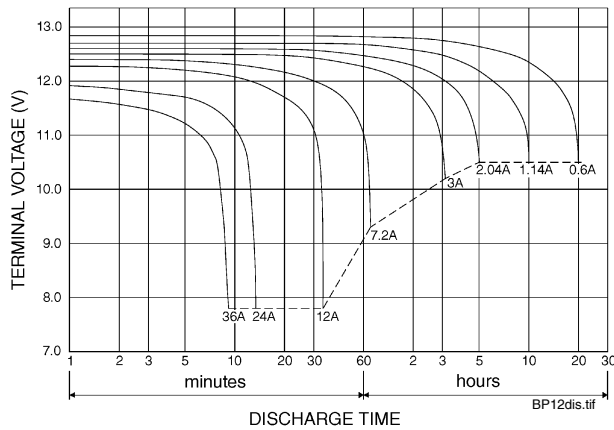

BP26-12 Battery Discharge Characteristics (25°C/77°F)

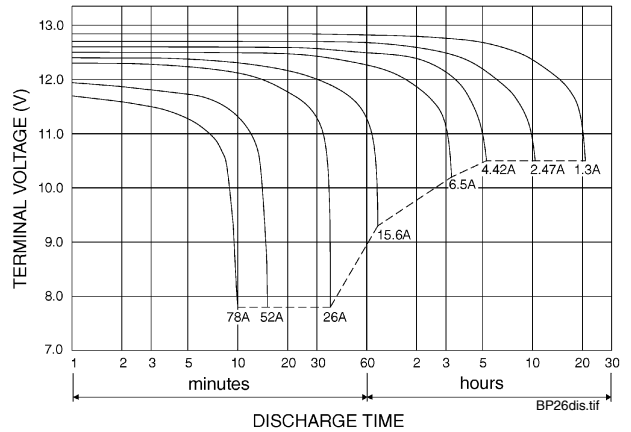

BP05-12



BP12-12



BP26-12



UPG BATTERY

UB1250 has the same specifications as previous Jolt SA1250; SA1272 to be replaced with UB1270 (specs/diagrams pending).

UB1250 (previously SA1250) Diagrams

UB1250/SA1250 discharge current vs. time

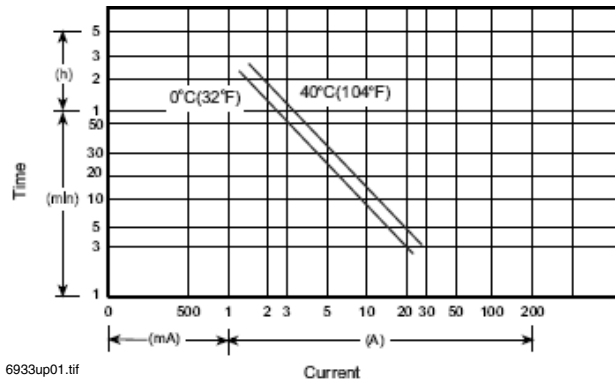

6933up01.tif

UB1250/SA1250 discharge characteristics (25°C/77°F)

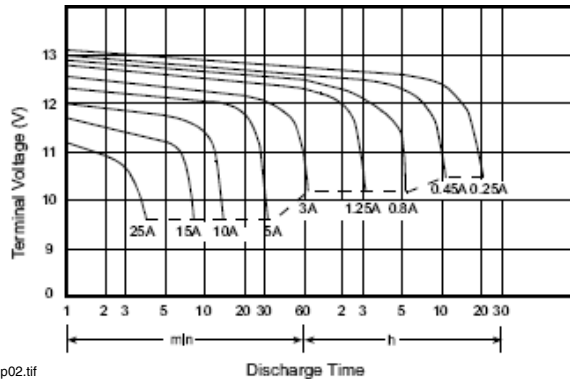

6933up02.tif

UB1250, SA1250 Specifications

- Nominal voltage: 12 V.
- Nominal capacity (20 hr): 5.0 AH.
- Dimensions: total height 107 mm (4.21"); container height 101 mm (3.98"); length 90 mm (3.54"); width 70 mm (2.76").
- Weight: approximately 1.83 kg (4.03 lbs).
- Container material: UL94HB ABS, UL94V-0 ABS.
- Internal resistance (25°C, 77°F): ~ 32 m.
- Discharge capacity under different temperatures:
 - 40°C: ~ 102%
 - 25°C: ~ 100%
 - 0°C: ~ 85%
- Capacity 25°C/77°F:
 - 20 hr @ 0.25 A: 5.0 AH.
 - 5 hr @ 0.8 A: 4.0 AH.
 - 1 hr @ 3.0 A: 3.0 AH.
 - 1 C @ 5.0 A: 2.5 AH.
- Charging voltage (25°C, 77°F):
 - Standby use: 13.65 V ± 0.15 V.
 - Cycle use: 14.7 V ± 0.3 V.
- Maximum discharge current: 60 A (5 sec).
- Maximum charging current: 1.5 A.
- Self-discharge residual capacity (25°C, 77°F):
 - After 3 months: ~ 90%.
 - After 6 months: ~ 82%.
 - After 12 months: ~ 70%.

SA1272 Diagrams

SA1272 discharge current vs. time

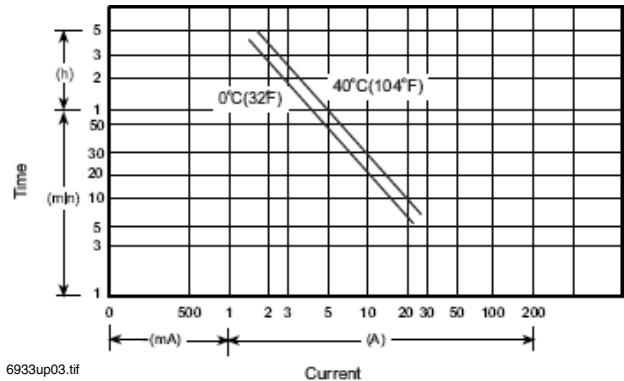

6933up03.tif

SA1272 discharge characteristics (25°C/77°F)

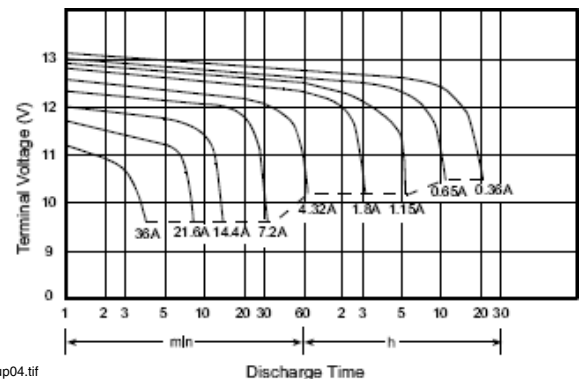

6933up04.tif

SA1272 Specifications

- Nominal voltage: 12 V.
- Nominal capacity (20 hr): 7.2 AH.
- Dimensions: total height 100 mm (3.94"); container height 94 mm (3.70"); length 151 mm (5.95"); width 65 mm (2.56").
- Weight: approximately 2.66 kg (5.85 lbs).
- Container material: UL94HB ABS, UL94V-0 ABS.
- Internal resistance (25°C, 77°F): ~ 22 m.
- Discharge capacity under different temperatures:
 - 40°C: ~ 102%
 - 25°C: ~ 100%
 - 0°C: ~ 85%
- Capacity 25°C/77°F:
 - 20 hr @ 0.36 A: 7.2 AH.
 - 5 hr @ 1.15 A: 5.76 AH.
 - 1 hr @ 4.32 A: 4.32 AH.
 - 1 C @ 7.2 A: 3.6 AH.
- Charging voltage (25°C, 77°F):
 - Standby use: 13.65 V ± 0.15 V.
 - Cycle use: 14.7 V ± 0.3 V.
- Maximum discharge current: 90 A (5 sec).
- Maximum charging current: 2.16 A.
- Self-discharge residual capacity (25°C, 77°F):
 - After 3 months: ~ 90%.
 - After 6 months: ~ 82%.
 - After 12 months: ~ 70%.

UPG BATTERY

Same specifications as previous Jolt models; packaging and part numbers are the only changes.

UB12120 (was SA12120) Diagrams

UB12120/SA12120 discharge current vs. time

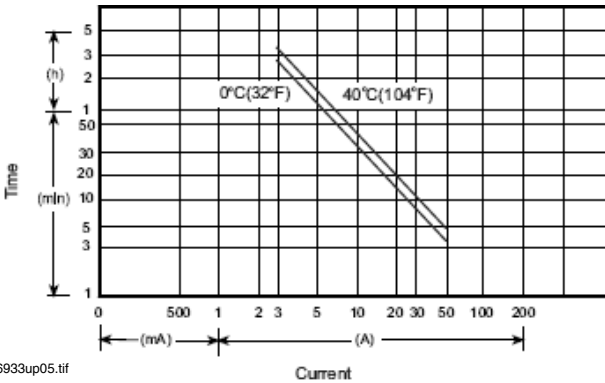

6933up05.tif

UB12120/SA12120 discharge characteristics (25°C/77°F)

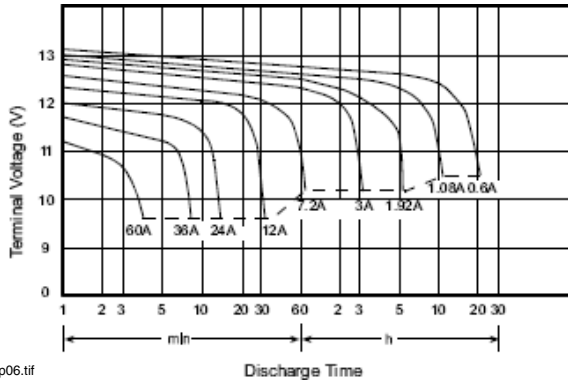

6933up06.tif

UB12120, SA12120 Specifications

- Nominal voltage: 12 V.
 - Nominal capacity (20 hr): 12.0 AH.
 - Dimensions: total height 100 mm (3.94"); container height 94 mm (3.70"); length 151 mm (5.95"); width 98 mm (3.86").
 - Weight: approximately 4.10 kg (9.04 lbs).
 - Container material: UL94HB ABS, UL94V-0 ABS.
 - Internal resistance (25°C, 77°F): ~ 14 m.
 - Discharge capacity under different temperatures:
 - 40°C: ~ 102%
 - 25°C: ~ 100%
 - 0°C: ~ 85%
 - Capacity 25°C/77°F:
 - 20 hr @ 0.6 A: 12.0 AH.
 - 5 hr @ 1.92 A: 9.6 AH.
 - 1 hr @ 7.2 A: 7.2 AH.
 - 1 C @ 12.0 A: 6.0 AH.
 - Charging voltage (25°C, 77°F):
 - Standby use: 13.65 V ± 0.15 V.
 - Cycle use: 14.7 V ± 0.3 V.
- Maximum discharge current: 120 A (5 sec).
 Maximum charging current: 3.6 A.
 Self-discharge residual capacity (25°C, 77°F):
 After 3 months: ~ 90%.
 After 6 months: ~ 82%.
 After 12 months: ~ 70%.

UB12180 (was SA12180) Diagrams

UB12180/SA12180 discharge current vs. time

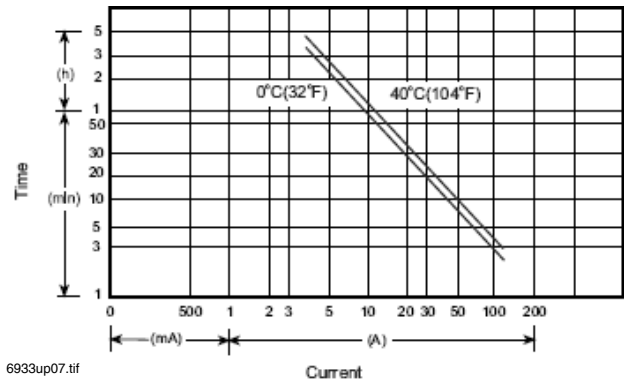

6933up07.tif

UB12180/SA12180 discharge characteristics (25°C/77°F)

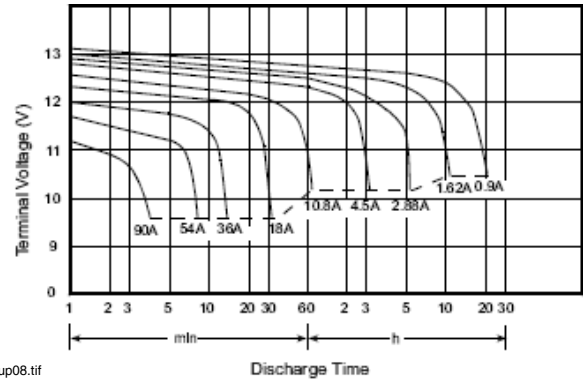

6933up08.tif

UB12180, SA12180 Specifications

- Nominal voltage: 12 V.
 - Nominal capacity (20 hr): 18.0 AH.
 - Dimensions: total height 167 mm (6.58"); container height 167 mm (6.58"); length 181 mm (7.13"); width 76 mm (2.99").
 - Weight: approximately 6.06 kg (13.36 lbs).
 - Container material: UL94HB ABS, UL94V-0 ABS.
 - Internal resistance (25°C, 77°F): ~ 13 m.
 - Discharge capacity under different temperatures:
 - 40°C: ~ 102%
 - 25°C: ~ 100%
 - 0°C: ~ 85%
 - Capacity 25°C/77°F:
 - 20 hr @ 0.9 A: 18.0 AH.
 - 5 hr @ 2.88 A: 14.4 AH.
 - 1 hr @ 10.8 A: 10.8 AH.
 - 1 C @ 18.0 A: 9.0 AH.
 - Charging voltage (25°C, 77°F):
 - Standby use: 13.65 V ± 0.15 V.
 - Cycle use: 14.7 V ± 0.3 V.
- Maximum discharge current: 300 A (5 sec).
 Maximum charging current: 5.4 A.
 Self-discharge residual capacity (25°C, 77°F):
 After 3 months: ~ 90%.
 After 6 months: ~ 82%.
 After 12 months: ~ 70%.

UPG BATTERY

Same specifications as previous Jolt models; packaging and part numbers are the only changes.

UB12260 (was SA12260) Diagrams

UB12260/SA12260 discharge current vs. time

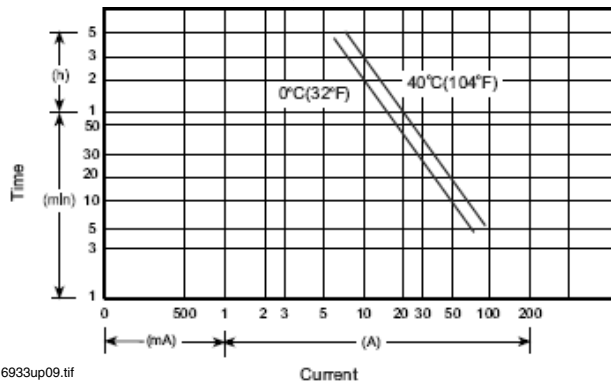

6933up09.tif

UB12260/SA12260 discharge characteristics (25°C/77°F)

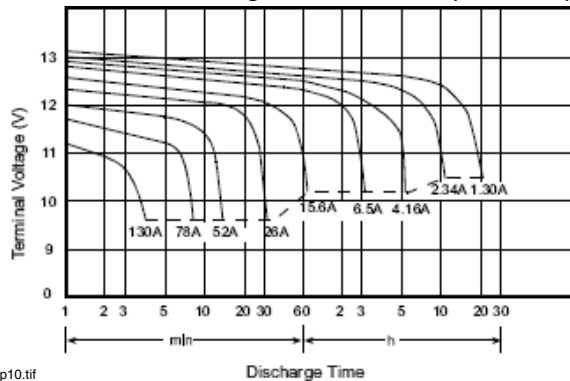

6933up10.tif

UB12260, SA12260 Specifications

- Nominal voltage: 12 V.
- Nominal capacity (20 hr): 26.0 AH.
- Dimensions: total height 125 mm (4.92"); container height 125 mm (4.92"); length 166 mm (6.54"); width 175 mm (6.89").
- Weight: approximately 8.80 kg (19.40 lbs).
- Container material: UL94HB ABS, UL94V-0 ABS.
- Internal resistance (25°C, 77°F): ~ 10 m.
- Discharge capacity under different temperatures:
 - 40°C: ~ 102%
 - 25°C: ~ 100%
 - 0°C: ~ 85%
- Capacity 25°C/77°F:
 - 20 hr @ 1.3 A: 26.0 AH.
 - 5 hr @ 4.16 A: 20.8 AH.
 - 1 hr @ 15.6 A: 15.6 AH.
 - 1 C @ 26.0 A: 13.0 AH.
- Charging voltage (25°C, 77°F):
 - Standby use: 13.65 V ± 0.15 V.
 - Cycle use: 14.7 V ± 0.3 V.
- Maximum discharge current: 300 A (5 sec).
- Maximum charging current: 7.8 A.
- Self-discharge residual capacity (25°C, 77°F):
 - After 3 months: ~ 90%.
 - After 6 months: ~ 82%.
 - After 12 months: ~ 70%.

UB12550 (was SA12550) Diagrams

UB12550/SA12550 discharge current vs. time

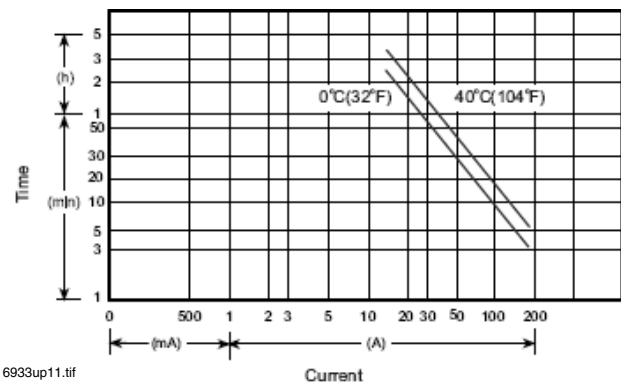

6933up11.tif

UB12550/SA12550 discharge characteristics (25°C/77°F)

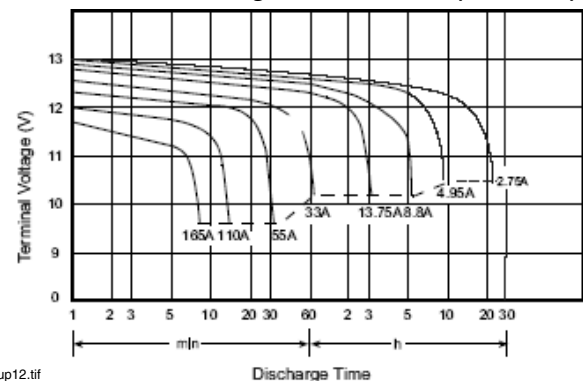

6933up12.tif

UB12550, SA12550 Specifications

- Nominal voltage: 12 V.
- Nominal capacity (20 hr): 55.0 AH.
- Dimensions: total height 234.5 mm (9.23"); container height 216.5 mm (8.52"); length 229 mm (9.02"); width 138 mm (5.43").
- Weight: approximately 19.0 kg (41.8 lbs).
- Container material: UL94HB ABS, UL94V-0 ABS.
- Internal resistance (25°C, 77°F): ~ 8 m.
- Discharge capacity under different temperatures:
 - 40°C: ~ 102%
 - 25°C: ~ 100%
 - 0°C: ~ 85%
- Capacity 25°C/77°F:
 - 20 hr @ 2.75 A: 55.0 AH.
 - 5 hr @ 8.8 A: 44.0 AH.
 - 1 hr @ 33.0 A: 33.0 AH.
 - 1 C @ 55.0 A: 27.5 AH.
- Charging voltage (25°C, 77°F):
 - Standby use: 13.65 V ± 0.15 V.
 - Cycle use: 14.7 V ± 0.3 V.
- Maximum discharge current: 600 A (5 sec).
- Maximum charging current: 16.5 A.
- Self-discharge residual capacity (25°C, 77°F):
 - After 3 months: ~ 90%.
 - After 6 months: ~ 82%.
 - After 12 months: ~ 70%.

UPG BATTERY

Same specifications as previous Jolt models; packaging and part numbers are the only changes.

UB121000 (XSA121000A) Diagrams

UB121000/XSA121000A discharge current vs. time

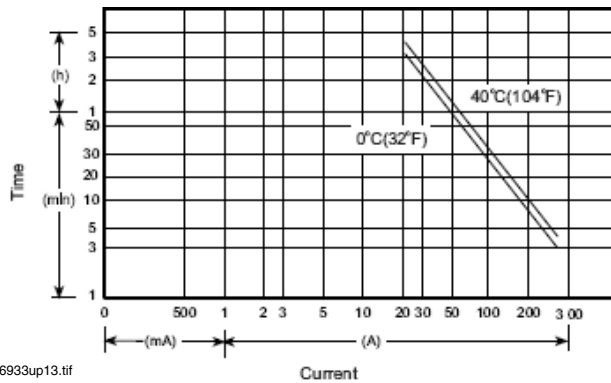

6933up13.tif

UB121000/XSA121000A discharge characteristics (25°C/77°F)

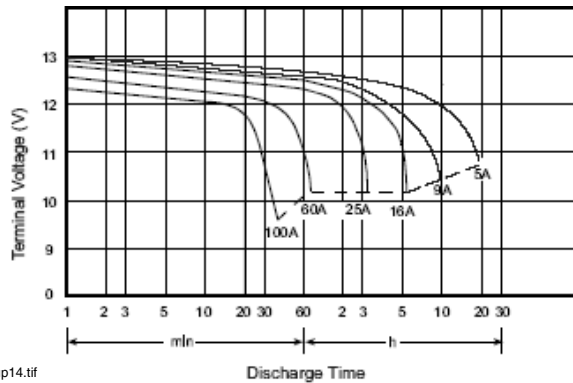

6933up14.tif

UB121000 (XSA121000A) Diagrams

- Nominal voltage: 12 V.
- Nominal capacity (20 hr): 100.0 AH.
- Dimensions: total height 221 mm (8.70"); container height 214 mm (8.43"); length 329 mm (12.95"); width 172 mm (6.77").
- Weight: approximately 34.00 kg (74.8 lbs).
- Container material: UL94HB ABS, UL94V-0 ABS.
- Internal resistance (25°C, 77°F): ~ 6.5 m.
- Discharge capacity under different temperatures:
 - 40°C: ~ 102%
 - 25°C: ~ 100%
 - 0°C: ~ 85%
- Capacity 25°C/77°F:
 - 20 hr @ 5.0 A: 100.0 AH.
 - 5 hr @ 16.0 A: 80.0 AH.
 - 1 hr @ 60.0 A: 60.0 AH.
 - 1 C @ 100.0 A: 50.0 AH.
- Charging voltage (25°C, 77°F):
 - Standby use: 13.65 V ± 0.15 V.
 - Cycle use: 14.7 V ± 0.3 V.
- Maximum discharge current: 600 A (5 sec).
- Maximum charging current: 30 A.
- Self-discharge residual capacity (25°C, 77°F):
 - After 3 months: ~ 90%.
 - After 6 months: ~ 82%.
 - After 12 months: ~ 70%.

UPG Summary Diagrams

Summary discharge characteristics

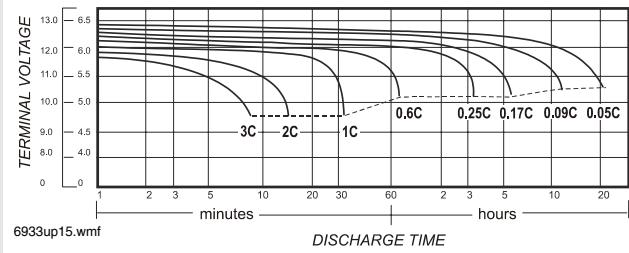

Summary discharge current vs. time curve (25°C/77°F)

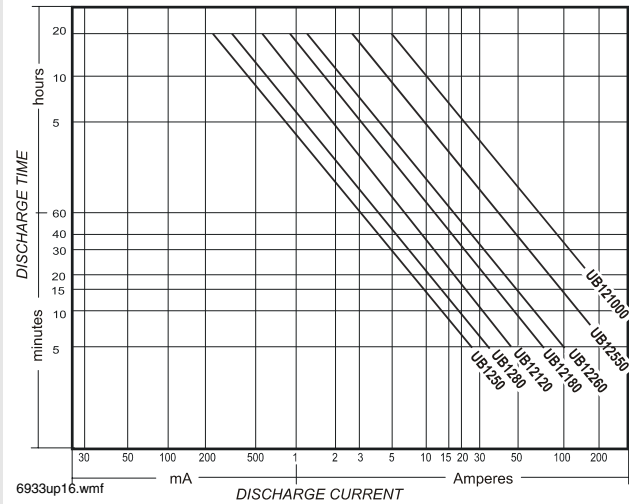

6933up16.wmf



6933ub1280.jpg



6933ub12260.jpg

UPG BATTERY

Same specifications as previous Jolt models;
packaging and part numbers are the only changes.

Charging Procedure: UPG Battery

| Application | Charging method | Charging voltage at 25°C (V/cell) | Temperature compensation coefficient of charging voltage (mV/°C/cell) | Maximum charging current (CA) | Charging time 0.1 CA, 25°C (h) | | Temp (°C) |
|--------------------------|---|-----------------------------------|---|-------------------------------|--------------------------------|-------------------|--------------------------|
| | | | | | 100% discharge | 50% discharge | |
| For standby power source | Constant voltage and constant current charging (with current restriction) | 2.25 ~ 2.30 | - 3.3 (-1.8 mV/°F/cell) | 0.3 | T ³ 24 | T ³ 20 | 0 – 40°C (32 – 104°F) |
| For cycle service | | 2.40 ~ 2.50 | - 5 (-2.8 mV/°F/cell) | 0.3 | 16 < T < 24 | 10 < T < 24 | |

Temperature compensation of charging voltage is not needed when using the batteries within 5°C to 35°C range.

NOTIFIER® is a registered trademark of Honeywell International Inc.
Batteries display trademarks of the manufacturer.
©2009 by Honeywell International Inc. All rights reserved. Unauthorized use
of this document is strictly prohibited.



This document is not intended to be used for installation purposes.
We try to keep our product information up-to-date and accurate.
We cannot cover all specific applications or anticipate all requirements.
All specifications are subject to change without notice.

For more information, contact Notifier. Phone: (203) 484-7161, FAX: (203) 484-7118.
www.notifier.com

→ N-ANN-80

80-Character LCD Serial Annunciator

Annunciators

General

The N-ANN-80 annunciator is a compact, backlit, 80-character LCD fire annunciator that mimics the Fire Alarm Control Panel (FACP) display. It provides system status indicators for AC Power, Alarm, Trouble, Supervisory, and Alarm Silenced conditions. The N-ANN-80 and the FACP communicate over a two-wire serial interface employing the ANN-BUS communication format. Connected devices are powered, via two additional wires, by either the host FACP or a remote UL-listed, filtered power supply. N-ANN-80 is black; for white order N-ANN-80-W.

The N-ANN-80 displays English-language text of system point information including device type, zone, independent point alarm, trouble or supervisory status, as well as any custom alpha labels programmed into the control panel. It includes control switches for remote control of critical system functions. (A keyswitch prevents unauthorized operation of the control switches.)

Up to eight N-ANN-80s may be connected to the ANN-BUS of each FACP. Minimal programming is required, which saves time during system commissioning. The N-ANN-80 is compatible with NOTIFIER FACPs with an ANN-BUS, such as the NFW-50.



Features

- Listed to UL Standard 864, 9th Edition.
- Backlit 80-character LCD display (20 characters x 4 lines).
- Mimics all display information from the host panel.
- Control switches for System Acknowledge, Signal Silence, Drill, and Reset.
- Control switches can be independently enabled or disabled at the FACP.
- Keyswitch enables/disables control switches and mechanically locks annunciator enclosure
- Keyswitch can be enabled or disabled at the FACP.
- Enclosure supervised for tamper.
- System status LEDs for AC Power, Alarm, Trouble, Supervisory, and Alarm Silence.
- Local sounder can be enabled or disabled at the FACP.
- N-ANN-80 connects to the ANN-BUS terminal on the FACP and requires minimal panel programming.
- Displays device type identifiers, individual point alarm, trouble, supervisory, zone, and custom alpha labels.
- Time-and date display field.
- Surface mount directly to wall or to single, double, or 4" square electrical box.
- Semi-flush mount to single, double, or 4" square electrical box. Use ANN-SB80KIT for angled view mounting.
- Can be remotely located up to 6,000 feet (1,800 m) from the panel.
- Backlight turns off during AC loss to conserve battery power but will turn back on if an alarm condition occurs.
- May be powered by 24 VDC from the host FACP or by remote power supply (requires 24 VDC).
- Up to eight N-ANN-80s can be connected on the ANN-BUS.

Controls and Indicators

- AC Power
- Alarm

- Trouble
- Supervisory
- Alarm Silenced

Specifications

- **Operating voltage range:** 18 VDC to 28 VDC.
- **Current consumption @ 24 VDC nominal (filtered and non-resettable):** 40 mA maximum.
- **Ambient temperature:** 32°F to 120°F (0°C to 49°C).
- **Relative humidity:** 93% ± 2% RH (noncondensing) at 32°C ± 2°C (90°F ± 3°F).
- 5.375" (13.65 cm.) high x 6.875" (17.46 cm.) wide x 1.375" (3.49 cm.) deep.
- For use indoors in a dry location.
- All connections are power-limited and supervised.

Agency Listings and Approvals

The listings and approvals below apply to the N-ANN-80. In some cases, certain modules may not be listed by certain approval agencies, or listing may be in process. Consult factory for latest listing status.

- **UL:** S635
- **FM approved**
- **CSFM:** 7120-0028:240
- **MEA:** 442-06-E Vol. 2

The ANN-BUS

POWERING THE DEVICES ON THE ANN-BUS FROM AUXILIARY POWER SUPPLY

The ANN-BUS can be powered by an auxiliary power supply when the maximum number of ANN-BUS devices exceeds the ANN-BUS power requirements. See the FACP manual for more information.

ANN-BUS DEVICE ADDRESSING

Each ANN-BUS device requires a unique address (ID Number) in order to communicate with the FACP. A maximum of 8 devices can be connected to the FACP ANN-BUS communication circuit. See the FACP manual for more information.

WIRE REQUIREMENTS: COMMUNICATIONS CIRCUIT

The N-ANN-80 connects to the FACP ANN-BUS communications circuit. To determine the type of wire and the maximum wiring distance that can be used with FACP ANN-BUS accessory modules, it is necessary to calculate the total worst case current draw for all modules on a single 4-conductor bus. The total worst case current draw is calculated by adding the individual worst case currents for each module.

NOTE: For total worst case current draw on a single ANN-BUS refer to appropriate FACP manual.

After calculating the total worst case current draw, the following table specifies the maximum distance the modules can be located from the FACP on a single wire run. The table ensures 6.0 volts of line drop maximum. In general, the wire length is limited by resistance, but for heavier wire gauges, capacitance is the limiting factor.

These cases are marked in the chart with an asterisk (*). Maximum length can never be more than 6,000 feet (1,800 m), regardless of gauge used. See table below.

WIRE REQUIREMENTS: POWER CIRCUIT

- 14 to 18 AWG (0.75 - 2.08 mm²) wire for 24 VDC power circuit is acceptable.
- All connections are power-limited and supervised.
- A maximum of eight N-ANN-80 modules may be connected to this circuit.

| Communication Pair Wiring Distance: FACP to Last ANN-BUS Module | | | | |
|---|-----------|-----------|-------------|------------|
| Total Worst Case Current Draw (amps) | 22 Gauge | 18 Gauge | 16 Gauge | 14 Gauge |
| 0.100 | 1,852 ft. | 4,688 ft. | * 6,000 ft. | *6,000 ft. |
| 0.200 | 926 ft. | 2,344 ft. | 3,731 ft. | 5,906 ft. |
| 0.300 | 617 ft. | 1,563 ft. | 2,488 ft. | 3,937 ft. |
| 0.400 | 463 ft. | 1,172 ft. | 1,866 ft. | 2,953 ft. |
| 0.500 | 370 ft. | 938 ft. | 1,493 ft. | 2,362 ft. |
| 0.600 | 309 ft. | 781 ft. | 1,244 ft. | 1,969 ft. |
| 0.700 | 265 ft. | 670 ft. | 1,066 ft. | 1,687 ft. |
| 0.800 | 231 ft. | 586 ft. | 933 ft. | 1,476 ft. |
| 0.900 | 206 ft. | 521 ft. | 829 ft. | 1,312 ft. |
| 1.000 (max.) | 185 ft. | 469 ft. | 746 ft. | 1,181 ft. |

WIRING CONFIGURATION

The following figure illustrates the wiring between the FACP and ANN-BUS devices.

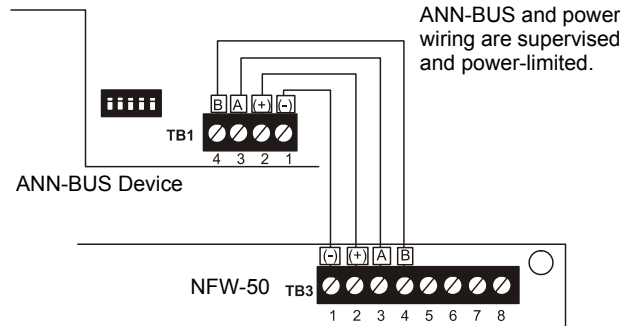

FACP Wiring to ANN-BUS Device

ORDERING OPTIONS:

N-ANN-80: Black 80 character LCD Annunciator.

N-ANN-80-W: White, 80 character LCD Annunciator.

ANN-SB80KIT-B: Black surface mount backbox with angled wedge.

ANN-SB80KIT-W: White surface mount backbox with angled wedge.

©2009 by Honeywell International Inc. All rights reserved. Unauthorized use of this document is strictly prohibited.



This document is not intended to be used for installation purposes. We try to keep our product information up-to-date and accurate. We cannot cover all specific applications or anticipate all requirements. All specifications are subject to change without notice.



Made in the U.S. A.

For more information, contact Notifier. Phone: (203) 484-7161, FAX: (203) 484-7118. www.notifier.com

→ NP-100(A), NP-100T(A), NP-100R(A)

dn-6995:b • A1-320



Addressable Photoelectric Detectors for the FireWarden Series

Addressable

General

The NP-100 and NP-100T addressable, low-profile plug-in photoelectric detectors use a state-of-the-art photoelectric sensing chamber with communications to provide open area protection and are used exclusively with NOTIFIER's **FireWarden Series** (FireWarden-100-2 and FireWarden-50) Addressable Fire Alarm Control Panels (FACPs). The NP-100T adds thermal sensors that will alarm at a fixed temperature of 135°F (57°C). Since these detectors are addressable, they will help emergency personnel quickly locate a fire during its early stages, potentially saving precious rescue time while also reducing property damage. Two LEDs on each sensor light to provide a local, visible sensor indication. Remote LED annunciator capability is available as an optional accessory (P/N RA100Z(A)). The NP-100R is a remote test capable detector for use with DNR(W) duct smoke detector housings.

Features

SLC loop:

- Two-wire loop connection.
- Unit uses base for wiring.

Addressing:

- Addressable by device.
- Direct Decade entry of address: 01 – 99 with FireWarden-100-2, and 01 – 50 with FireWarden-50.

Architecture:

- Unique single-source, dual-chamber design to respond quickly and dependably to a broad range of fires.
- Sleek, low-profile design.
- Integral communications and built-in type identification.
- Built-in tamper-resistant feature.
- Removable cover and insect-resistant screen for simple field cleaning.

Operation:

- Withstands air velocities up to 4,000 feet-per-minute (20 m/sec.) without triggering a false alarm.
- Factory preset at 1.5% nominal sensitivity for panel alarm threshold level.
- Visible LED “blinks” when the unit is addressed (communicating with the fire panel) and latches on in alarm.

Mechanicals:

- Sealed against back pressure.
- Direct surface mounting or electrical box mounting.
- Mounts to: single-gang box, 3.5" (8.89 cm) or 4.0" (10.16 cm) octagonal box, or 4.0" (10.16 cm) square electrical box (using a plaster ring — included).

Other system features:

- Fully coated circuit boards and superior RF/transient protection.
- 94-V0 plastic flammability rating.
- Low standby current.

Options:

- Remote LED output connection (P/N RA100Z).



NP-100 with B710LP base



NP-100T with B710LP base

Applications

Use photoelectric detectors in life-safety applications to provide a broad range of fire-sensing capability, especially where smoldering fires are anticipated. Ionization detectors are often better than photoelectric detectors at sensing fast, flaming fires.

Construction

These detectors are constructed of off-white LEXAN®. NP-100(T) plug-in, low-profile smoke detectors are designed to commercial standards and offer an attractive appearance.

Installation

NP-100(T) plug-in detectors use a detachable mounting base to simplify installation, service and maintenance. Mount base on box which is at least 1.5 inches (3.81 cm) deep. Suitable boxes include:

- 4.0" (10.16 cm) square box with plaster ring.
- 4.0" (10.16 cm) octagonal box.
- 3.5" (8.89 cm) octagonal box.
- Single-gang box.

NOTE: Because of the inherent supervision provided by the SLC loop, **end-of-line resistors** are not required. Wiring “T-taps” or branches are permitted for Style 4 (Class B) wiring. NP-100R mounts in a DNR(W) duct detector housing.

Operation

Each NP-100/T/R uses one of 99 possible addresses on the FireWarden-100-2 and one of 50 possible addresses on the FireWarden-50 Signaling Line Circuit (SLC). It responds to regular polls from the system and reports its type and status.

The NP-100/T/R addressable photoelectric sensor's unique unipolar chamber responds quickly and uniformly to a broad range of smoke conditions and can withstand wind gusts up to 4,000 feet-per-minute (20 m/sec.) without sending an alarm level signal. Because of its unipolar chamber, the NP-100/T/R is approximately two times more responsive than most photoelectric sensors. This makes it a more stable detector.

Detector Sensitivity Test

Each detector can have its sensitivity tested (required per NFPA 72, Chapter 14 on *Inspection, Testing and Maintenance*) when installed/connected to a FireWarden-100-2 or FireWarden-50 addressable fire alarm control panel. The results of the sensitivity test can be printed off the FireWarden-100-2 or FireWarden-50 for record keeping.

Specification

Voltage range: 15 – 32 VDC (peak).

Standby current: 300 µA @ 24 VDC.

LED current: 6.5 mA @ 24 VDC (latched "ON").

Air velocity: 4,000 ft./min. (20 m/sec.) maximum.

Diameter: 6.1" (15.5 cm) installed in B710LP base.

Height: 2.1" (5.33 cm) installed in B710LP base.

Weight: 3.6 oz. (102 g).

Operating temperature range: for NP-100: 0°C to 49°C (32°F to 120°F); for NP-100T: 0°C to 38°C (32°F to 100°F). NP-100R: installed in a DNR(W) -20°C to 70°C (-4°F to 158°F).

Temperature: 0°C – 49°C (32°F – 120°F).

Relative humidity: 10% – 93%, non-condensing.

Listings

Listings and approvals below apply to the NP-100 and NP-100T detectors. In some cases, certain modules may not be listed by certain approval agencies, or listing may be in process. Consult factory for latest listing status.

- UL Listed, file S1115.
- CSFM approved: file 7272-0028:231.
- MEA approved: file 243-02-E Vol. 2.
- Maryland State Fire Marshal: permit 2173.
- FM approved.

Product Line Information

NP-100: Addressable photoelectric detector; B710LP base included.

NP-100A: Same as NP-100 with ULC Listing (B710LPA base included).

NP-100T: Same as NP-100 but with *thermal* element; B710LP base included.

NP-100TA: Same as NP-100T with ULC Listing (B710LPABase included).

NP-100R: Remote test capable addressable photoelectric detector for use with a DNR(W) duct detector housing.

B710LP: Plug-in detector base. Dimensions: 6.1" (15.5 cm). Mounting: 4.0" (10.16 cm) square box with or without plaster ring, 4.0" (10.16 cm) octagonal box, 3.5" (8.89 cm) octagonal box, or single-gang box. All mounting boxes have a minimum depth of 1.5" (3.81 cm).

B224RB: Plug-in System Sensor *relay* detector base. **Diameter:** 6.2" (15.75 cm). **Mounting:** 4.0" (10.16 cm) square box with or without plaster ring, 4.0" (10.16 cm) octagonal box, or 3.5" (8.89 cm) octagonal box. All mounting boxes have a minimum depth of 1.5" (3.81 cm).

B224BI: Plug-in System Sensor *isolator* detector base. Maximum 25 devices between isolator bases (see DN-6994). **Diameter:** 6.2" (15.75 cm). **Mounting:** 4.0" (10.16 cm) square box with or without plaster ring, 4.0" (10.16 cm) octagonal box, or 3.5" (8.89 cm) octagonal box. All mounting boxes have a minimum depth of 1.5" (3.81 cm).

B200SR: Sounder base capable of producing temporal-3 or steady sound output.

ACCESSORIES:

RA100Z(A): Remote LED annunciator. 3 – 32 VDC. Mounts to a U.S. single-gang electrical box. *For use with B501 and B710LP bases only.*

SMK400E: Surface mounting kit provides for entry of surface wiring conduit. *For use with B501 base only.*

RMK400: Recessed mounting kit. *For use with B501 base only.*

M02-04-00: Test magnet.

M02-09-00: Test magnet with telescoping handle.

XR2B: Detector removal tool. Allows installation and/or removal of detector heads from bases in high ceiling applications.

XP-4: Extension pole for XR2B. Comes in three 5-foot (1.524 m) sections.

T55-127-010: Detector removal tool without pole.

BCK-200B: Black detector covers, box of 10 .

WCK-200B: White detector covers, box of 10 .

NOTIFIER® is a registered trademark of Honeywell International Inc. Bayblend® is a registered trademark of Bayer Corporation. ©2008 by Honeywell International Inc. All rights reserved. Unauthorized use of this document is strictly prohibited.



This document is not intended to be used for installation purposes.
We try to keep our product information up-to-date and accurate.
We cannot cover all specific applications or anticipate all requirements.
All specifications are subject to change without notice.

For more information, contact Notifier. Phone: (203) 484-7161, FAX: (203) 484-7118.
www.notifier.com

**NO
EXCUSES!**



FAD

Fire Alarm Documents Records / Programs / Software

The FAD is the perfect fit to meet the demanding code requirements today. SAE's number one goal is to manufacture code compliant solutions and this product allows you to do just that. NFPA 72 section 6.2.2.1 states, "A record of installed software and firmware version numbers shall be maintained at the location of the fire alarm control unit."

This durable 16 gauge steel enclosure with a solid piano hinge and key lock will keep all of your code required documents in one safe place. With a 2GB USB flash drive it stores your fire alarm software safe and secure eliminating the occurrences of the software not being on site when technicians arrive to service the system. Along with your fire alarm software you can store your test & inspection documents, service records, manuals & AS built drawings for the system. Using a standard USB B connector it allows you to plug in with any standard SB printer cable to upload or download information.

NFPA 72 section 10.18.2.1.2.8 If the documents are located in a separate enclosure or cabinet, the separate enclosure or cabinet shall be prominently labeled
FIRE ALARM DOCUMENTS.

Standard Features:

- Installed with a 2 gig digital flash drive with USB B connector
- 2 Key ring hooks to hold system keys
- Business card holder for key contacts
- Overall Dimensions are 12" x 13" tall and 2 ¼ deep
- 16 gauge steel box and cover for security
- durable powercoat baked on finish other colors available
- standard ¾" cat 30 key lock other lock assemblies available
- Solid stainless steel piano hinge
- permanently screened white ink 1" high "Fire Alarm Documents"
- Legend sheet for passwords and system information

The FAD is designed to hold critical manuals and documents with a durable steel sleeve. It has designated hooks to organize key rings and hold important business cards for easy access and reference. Inside the cover it has a organized note table that allows for documentation for passwords and other critical system information. The steel sleeve can be easily removed to hold a 1.5" three ring binder.

The innovation of a single gang cutout inside the box to implement the infinity line products with conduit knockout access enables you to provide other system functions for test and inspection. A drill switch or a shut off switch for testing are just a few examples. See the complete line of Infinity products for single gang electrical product solutions.



**ISO 9001
REGISTERED
COMPANY**



ACEBOX

Space Age Electronics, Inc.
www.1sae.com
800.486.1723 Toll Free
508.485.0966 Local
508.485.4740 Fax

High Security Industrial/Government Key Box



The number one high-security KNOX-BOX[®] is used for most commercial applications including businesses, schools, government and public buildings, community associations and apartment complexes. The 3200 Series KNOX-BOX with lift-off door holds keys, access cards and other small items necessary for emergency access.

Features and Benefits

- Holds up to 10 keys and access cards in interior compartment
- Ensures high security. Box and lock are UL[®] Listed
- Includes a Knox-Coat[®] proprietary finishing process that protects Knox products up to four times better than standard powder coat
- Resists moist conditions with a weather resistant door gasket
- Colors: Black, Dark Bronze or Aluminum
- Weight: Surface mount - 8 lbs.
Recessed mount - 9 lbs.

Options

- Alarm tamper switches (UL Listed)
- Recessed Mounting Kit (RMK) for recessed models only
- Inside switch for use on electrical doors, gates and other electrical equipment

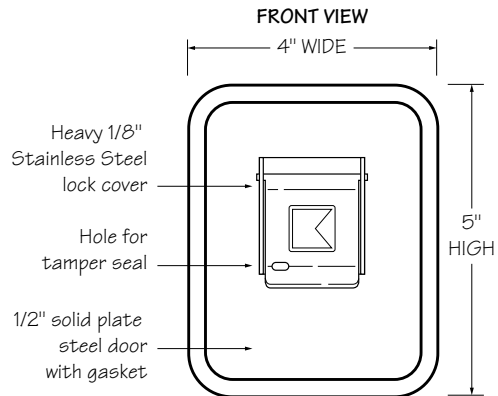

3200 Surface Mount

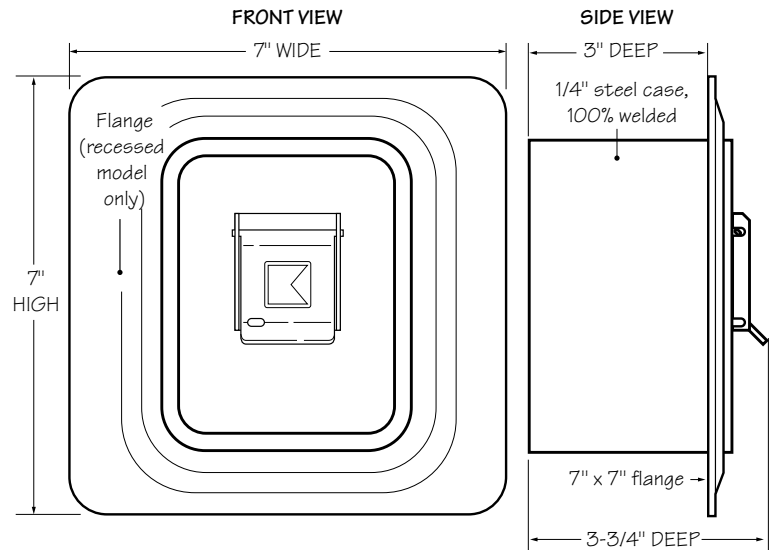

3200 Recessed Mount

Ordering Specifications

To insure procurement and delivery of the 3200 Series KNOX-BOX, it is suggested that the following specification paragraph be used:

KNOX-BOX surface/recessed mount with lift-off door, with/without UL Listed tamper switches. 1/4" plate steel housing, 1/2" thick steel door with interior gasket seal. Box and lock UL Listed. Lock has 1/8" thick stainless steel dust cover with tamper seal mounting capability.

Exterior Dimensions: Surface mount body - 5"H x 4"W x 3-3/4"D
Recessed mount flange- 7"H x 7"W

Lock: UL Listed. Double-action rotating tumblers and hardened steel pins accessed by a biased cut key.

Finish: Knox-Coat[®] proprietary finishing process

Colors: Black, Dark Bronze or Aluminum

P/N: 3200 Series KNOX-BOX (mfr's cat. ID)

Mfr's Name: **KNOX COMPANY**

**Suggested minimum mounting height
6 feet above ground**

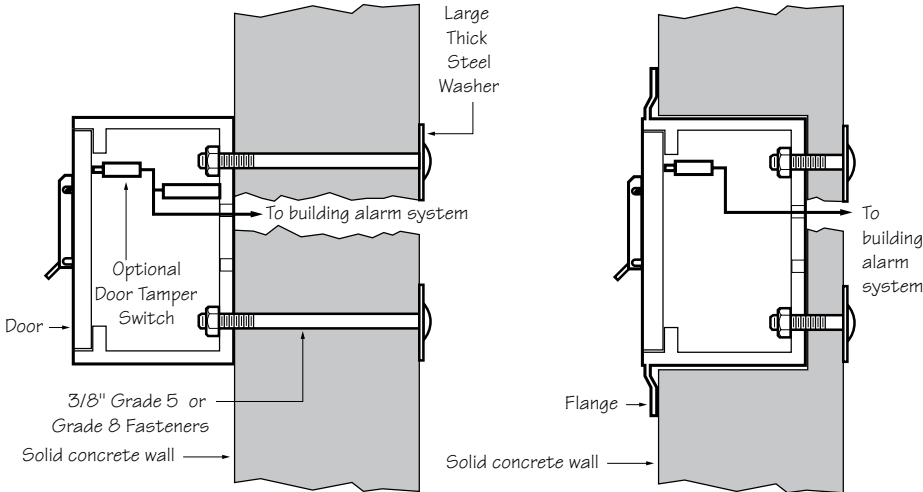

**3200 Series Lift-off Door
Surface Mount**

**3200 Series Lift-off Door
Recessed Mount**

Inside View

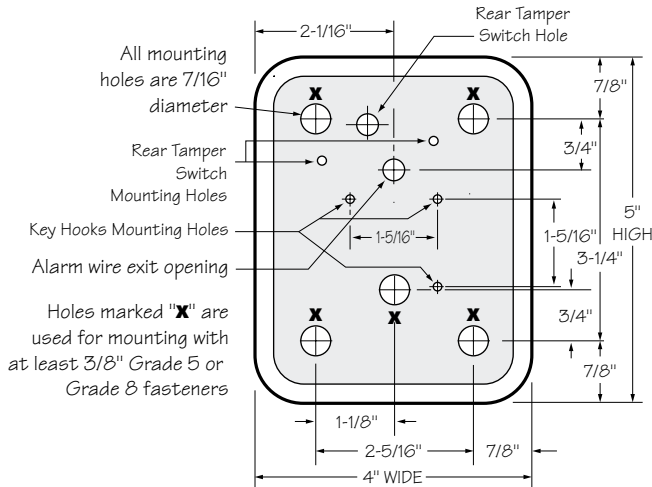

Attention: KNOX-BOX[®] is a very strong device that MUST be mounted properly to ensure maximum security and resist physical attack.

Knox[®] Rapid Entry System

The Knox Company manufactures a complete line of high security products including Knox-Box key boxes, key vaults, cabinets, key switches, padlocks, locking FDC caps, plugs and electronic master key security systems. For more information or technical assistance, please call Customer Service at 1-800-552-5669.

Recessed Mounting Kit

The 3200 Recessed Mounting Kit (RMK) is used for recessed models only. It contains a shell housing and mounting hardware to be cast-in-place in new concrete or masonry construction. After construction is completed, the KNOX-BOX mounts inside the recessed shell housing. The RMK may only be used in new concrete or masonry construction.

Installation In Cast Concrete

The optional Recessed Mounting Kit is for use in new concrete or masonry construction only. The kit includes a shell housing and mounting hardware to be cast-in-place. The KNOX-BOX is mounted into the shell housing after construction is completed.

Dimensions

Rough-in Dimensions: 6-1/2"H x 6-1/2"W x 5"D

IMPORTANT: Care should be taken to insure that the front of the RMK shell housing, including the cover plate and screw heads, is flush with the finish wall. The RMK must be plumbed to insure vertical alignment of the vault.

Recessed Mounting Using Recessed Mounting Kit (RMK)

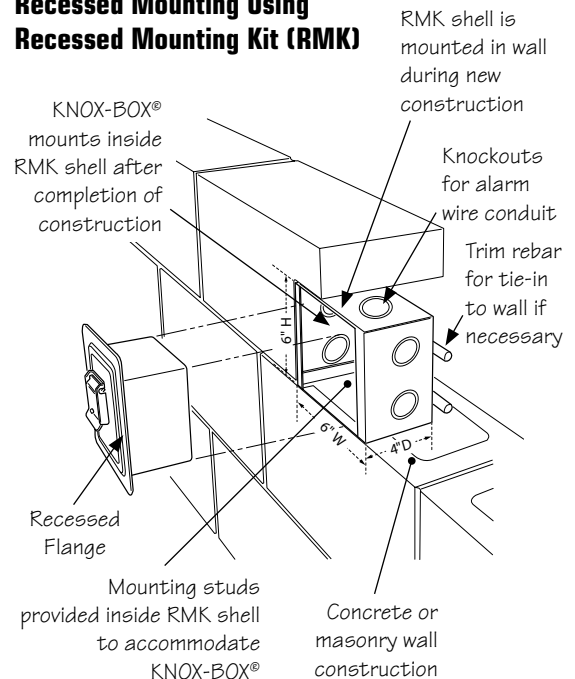

→ NOT-BG12LX

Addressable Manual Pull Station For FireWarden Series Panels



Intelligent/Addressable Devices

General

The Notifier NOT-BG12LX is a state-of-the-art, dual-action (i.e., requires two motions to activate the station) pull station that includes an addressable interface for FireWarden series intelligent control panels, and the NSP-25 panel. Because the NOT-BG12LX is addressable, the control panel can display the exact location of the activated manual station. This leads fire personnel quickly to the location of the alarm.

Features

- Maintenance personnel can open station for inspection and address setting without causing an alarm condition.
- Built-in bicolor LED, which is visible through the handle of the station, flashes in normal operation and latches steady red when in alarm.
- Handle latches in down position and the word “ACTIVATED” appears to clearly indicate the station has been operated.
- Captive screw terminals wire-ready for easy connection to SLC loop (accepts up to 12 AWG/3.25 mm² wire).
- Can be surface mounted (with SB-10 or SB-I/O) or semi-flush mounted. Semi-flush mount to a standard single-gang, double-gang, or 4" (10.16 cm) square electrical box.
- Smooth dual-action design.
- Meets ADAAG controls and operating mechanisms guidelines (Section 4.1.3[13]); meets ADA requirement for 5 lb. maximum activation force.
- Highly visible.
- Attractive shape and textured finish.
- Key reset.
- Includes Braille text on station handle.
- Optional trim ring (BG12TR).
- Meets UL 38, Standard for Manually Actuated Signaling Boxes.

Construction

Shell, door, and handle are molded of durable polycarbonate material with a textured finish.

Specifications

- **Shipping Weight:** 9.6 oz. (272.15 g)
- **Normal operating voltage:** 24 VDC.
- **Maximum SLC loop voltage:** 28.0 VDC.
- **Maximum SLC loop current:** μ A.
- **Temperature Range:** 32°F to 120°F (0°C to 49°C)
- **Relative Humidity:** 10% to 93% (noncondensing)
- **For use indoors in a dry location**

Installation

The NOT-BG12LX will mount semi-flush into a single-gang, double-gang, or standard 4" (10.16 cm) square electrical outlet box, or will surface mount to the model SB-10 or SB-I/O surface backbox. If the NOT-BG12LX is being semi-flush mounted, then the optional trim ring (BG12TR) may be used.



The NOT-BG12LX
Addressable Manual Pull Station

The BG12TR is usually needed for semi-flush mounting with 4" (10.16 cm) or double-gang boxes (not with single-gang boxes).

Operation

Pushing in, then pulling down on the handle causes it to latch in the down/activated position. Once latched, the word “ACTIVATED” (in bright yellow) appears at the top of the handle, while a portion of the handle protrudes from the bottom of the station. To reset the station, simply unlock the station with the key and pull the door open. This action resets the handle; closing the door automatically resets the switch.

Each manual station, on command from the control panel, sends data to the panel representing the state of the manual switch. Two rotary decimal switches allow address settings (1 – 99 on NFW2-100/NFW2-100C, 1 – 50 for NFW-50/NFW-50C).

Architectural/Engineering Specifications

Manual Fire Alarm Stations shall be non-coded, with a key-operated reset lock in order that they may be tested, and so designed that after actual Emergency Operation, they cannot be restored to normal except by use of a key. An operated station shall automatically condition itself so as to be visually detected as activated. Manual stations shall be constructed of red-colored polycarbonate material with clearly visible operating instructions provided on the cover. The word FIRE shall appear on the front of the stations in white letters, 1.00 inches (2.54 cm) or larger. Stations shall be suitable for surface mounting on matching backbox SB-10 or SB-I/O; or semi-flush mounting on a standard single-gang, double-gang, or 4" (10.16 cm) square electrical box, and shall be installed within

the limits defined by the Americans with Disabilities Act (ADA) or per national/local requirements. Manual Stations shall be Underwriters Laboratories listed.

Manual stations shall connect with two wires to one of the control panel SLC loops. The manual station shall, on command from the control panel, send data to the panel representing the state of the manual switch. Manual stations shall provide address setting by use of rotary decimal switches.

Product Line Information

NOT-BG12LX: Dual-action addressable pull station. Includes key locking feature.

NOT-BG12LXA: *Canadian* Dual-action addressable pull station. Includes key locking feature.

SB-10: Surface backbox; metal.

SB-I/O: Surface backbox; plastic.

BG12TR: Optional trim ring.

17021: Keys, set of two.

Agency Listings and Approvals

In some cases, certain modules or applications may not be listed by certain approval agencies, or listing may be in process. Consult factory for latest listing status.

- **UL Listed:** S692 (listed for Canadian and non-Canadian applications)
- **MEA:** 67-02-E Vol. IV
- **CSFM:** 7150-0028:0199
- **FDNY:**
- **FM Approved**

Patented: U.S. Patent No. D428,351; 6,380,846; 6,314,772; 6,632,108.

Notifier® is a registered trademark of Honeywell International Inc.
©2010 by Honeywell International Inc. All rights reserved. Unauthorized use of this document is strictly prohibited.



This document is not intended to be used for installation purposes.
We try to keep our product information up-to-date and accurate.
We cannot cover all specific applications or anticipate all requirements.
All specifications are subject to change without notice.



Made in the U.S. A.

For more information, contact Notifier. Phone: (203) 484-7161, FAX: (203) 484-7118.
www.notifier.com



March 30, 2004

DN-4587 • J-133

MIZ-24S MINI HORN SERIES

Section: Audio/Visual Devices

GENERAL

Wheelock Series MIZ piezoelectric Mini Horns are compact electronic alarm appliances that are listed under UL Standard 464 for Audible Appliances in Public Mode Fire Protection Systems. The Series MIZ-24S models provide a field selectable Continuous or Code 3 horn tone when connected directly to a fire alarm control panel. They can also provide a synchronized code 3 horn tone when used in conjunction with Wheelock's Sync Module (SM), Dual Sync Module (DSM) or a power supply with the patented Wheelock Sync protocol. The series MIZ appliances are attractive, offer high sound output along with low current draw and are ideal for alarm signaling in individual rooms, apartments, hotels, motels and offices. Color choices of red or off-white will blend with any décor.



California State Fire Marshal
7135-0785:115



FEATURES

- Field selectable settings for Temporal (Code 3) or Continuous Horn
- Synchronized code 3 horn when used with Wheelock's Sync Module
- Designed to meet or exceed NFPA/ANSI standards
- Convenient mounting to any standard single-gang box
- Beauty plugs to cover mounting screws
- No additional trimplate required for flush mounting
- Fast installation with In/Out screw terminals using #12 to #18 AWG
- High sound output with low current draw
- Available in red or off-white color

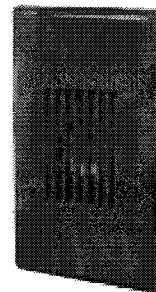

Wiring Diagrams (for all models)

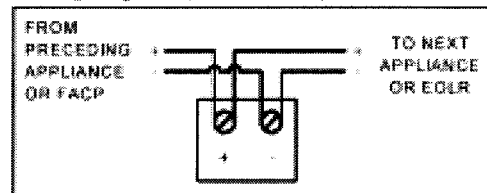

APPLICATIONS:

- Individual Rooms
- Apartments
- Hotels
- Motels
- Offices

| Model | Description | Mounting Options** |
|-----------|----------------|--------------------|
| MIZ-24S-R | 24 Volt, Red | B |
| MIZ-24S-W | 24 Volt, White | B |

General Notes

- Mini Horn models are Listed for indoor use with a temperature range of 32° F to 120° F (0° C to 49° C) and maximum humidity of 93% RH ±2%.
- Rated Input voltage (either filtered DC or unfiltered full-wave-rectified FWR): 16-33 VDC (for 24 VDC MIZ-24S models)
- **Refer to DN-6111 for Mounting Options.

NOTIFIER® is a Honeywell company.

This document is not intended to be used for installation purposes. We try to keep our product information up-to-date and accurate. We cannot cover all specific applications or anticipate all requirements. All specifications are subject to change without notice. For more information, contact NOTIFIER. Phone: (203) 484-7161 FAX: (203) 484-7118

12 Clintonville Road, Northford, Connecticut 06472

ISO 9001
CERTIFIED
ENGINEERING & MANUFACTURING
QUALITY SYSTEMS

Architects and Engineers Specifications

The notification appliance shall be a Wheelock MIZ-24S audible appliance or approved equal. The Notification Appliance shall be electronic and shall have field selectable settings for Temporal (Code 3) or continuous horn and support coded systems operation. The anechoic sound pressure measurement on Temporal (Code 3) setting shall be 87 dBA minimum at 24VDC. The anechoic sound pressure measurement on Continuous Horn setting shall be 87 dBA minimum at 24 VDC. Operating voltages shall be 24 VDC using filtered power or unfiltered power supply (full-wave-rectified). All models shall have provision for standard reverse polarity type supervision and IN/OUT wiring using terminals that accept #12 to #18 AWG wiring. The appliances shall be mounted indoors and mount on standard single-gang electrical backboxes requiring no additional trimplates or adapters.

| Model | Regulated UL Voltage | Average RMS Current (AMPS) | Reverberant dBA Per UL 464 @ 10ft | | Anechoic dBA @ 10ft | | Mounting Options |
|---------|----------------------|----------------------------|-----------------------------------|--------|---------------------|--------|------------------|
| | | | Continuous | Code 3 | Continuous | Code 3 | |
| | | | dBA | dBA | dBA | dBA | |
| MIZ-24S | 16 | 0.012 | 79.7 | 75.5 | 84.8 | 84.7 | B |
| | 24 | 0.017 | 83.2 | 78.8 | 87.9 | 87.9 | |
| | 33 | 0.024 | 85.8 | 81.3 | 90.6 | 89.7 | |

*Average RMS Current is per UL average RMS method and Average Mean Current is per UL Average Mean method. For rate in Rush and Peak current across the UL listed voltage range for both filtered DC and unfiltered VRMS (FWR), see installation instructions.

NOTE: All CAUTIONS and WARNINGS are identified by the symbol . All warnings are printed in bold capital letters. WARNING: PLEASE READ THESE SPECIFICATIONS AND ASSOCIATED INSTALLATION INSTRUCTIONS CAREFULLY BEFORE USING, SPECIFYING OR APPLYING THIS PRODUCT. FAILURE TO COMPLY WITH ANY OF THESE INSTRUCTIONS, CAUTIONS OR WARNINGS COULD RESULT IN IMPROPER APPLICATION, INSTALLATION AND/OR OPERATION OF THESE PRODUCTS IN AN EMERGENCY SITUATION, WHICH COULD RESULT IN PROPERTY DAMAGE, AND SERIOUS INJURY OR DEATH TO YOU AND/OR OTHERS. WARNING: CONTACT WHEELLOCK FOR THE CURRENT "INSTALLATION INSTRUCTIONS" (P84408) AND "GENERAL INFORMATION" SHEET (P82380) ON THESE PRODUCTS. THESE DOCUMENTS UNDERGO PERIODIC CHANGES. IT IS IMPORTANT THAT YOU HAVE CURRENT INFORMATION ON THESE PRODUCTS. THESE MATERIALS CONTAIN IMPORTANT INFORMATION THAT SHOULD BE READ PRIOR TO SPECIFYING OR INSTALLING THESE PRODUCTS, INCLUDING:

- **TOTAL CURRENT REQUIRED BY ALL APPLIANCES CONNECTED TO SYSTEM SECONDARY POWER SOURCES.**
- **FUSE RATINGS ON NOTIFICATION APPLIANCE CIRCUITS TO HANDLE PEAK CURRENTS FROM ALL APPLIANCES ON THOSE CIRCUITS.**
- **THE VOLTAGE APPLIED TO THESE PRODUCTS MUST BE WITHIN THEIR RATED VOLTAGE RANGE.**
- **FAILURE TO COMPLY WITH THE INSTALLATION INSTRUCTIONS OR GENERAL INFORMATION SHEETS COULD RESULT IN IMPROPER INSTALLATION, APPLICATION, AND/OR OPERATION OF THESE PRODUCTS IN AN EMERGENCY SITUATION, WHICH COULD RESULT IN PROPERTY DAMAGE AND SERIOUS INJURY OR DEATH TO YOU AND/OR OTHERS.**
- **CONDUCTOR SIZE (AWG), LENGTH AND AMPACITY SHOULD BE TAKEN INTO CONSIDERATION PRIOR TO DESIGN AND INSTALLATION OF THESE PRODUCTS, PARTICULARLY IN RETROFIT INSTALLATIONS.**

CAUTION: Audible Horn appliances are not designed to be used on coded systems in which the applied voltage is cycled on and off.

Wheelock products must be used within their published specifications and must be PROPERLY specified, applied, installed, operated, maintained and operationally tested in accordance with their installation instructions at the time of installation and at least twice a year or more often and in accordance with local, state and federal codes, regulations and laws. Specification, application, installation, operation, maintenance and testing must be performed by qualified personnel for proper operation in accordance with all of the latest National Fire Protection Association (NFPA), Underwriters' Laboratories (UL), National Electrical Code (NEC), Occupational Safety and Health Administration (OSHA), local, state, county, province, district, federal and other applicable building and fire standards, guidelines, regulations, laws and codes including, but not limited to, all appendices and amendments and the requirements of the local authority having jurisdiction (AHJ).

NOTE: Due to continuous development of our products, specifications and offerings are subject to change without notice in accordance with Wheelock Inc. standard terms and conditions.



Finally, Design and Safety Meet...



Description:

The Wheelock® Exceder™ Series of notification appliances feature a sleek modern design that will please building owners with reduced total cost of ownership. Installers will benefit from its comprehensive feature list, including the most candela options in one appliance, low current draw, no tools needed for setting changes, voltage test points, 12/24 VDC operation, universal mounting base and multiple mounting options for both new and retrofit construction.

The Wheelock® Exceder™ Series incorporates high reliability and high efficiency optics to minimize current draw allowing for a greater number of appliances on the notification appliance circuit. All strobe models feature an industry first of 8 candela settings on a single appliance. Models with an audible feature 3 sound settings (90, 95, 99 dB). All switches to change settings, can be set without the use of a tool and are located behind the appliance to prevent tampering. Wall models feature voltage test points to take readings with a voltage meter for troubleshooting and AHJ inspection.

The Wheelock® Exceder™ Series of wall and ceiling notification appliances feature a Universal Mounting Base (UMB) designed to simplify the installation and testing of horns, strobes, and combination horn strobes. The separate universal mounting base can be pre-wired to allow full testing of circuit wiring before the appliance is installed and the surface is finished. It comes complete with a Contact Cover for protection against dirt, dust, paint and damage to the contacts. The Contact Cover also acts as a shunting device to allow pre-wire testing for common wiring issues. The Contact Cover is polarized to prevent it from being installed incorrectly and prevents the appliance from being installed while it is on the UMB. When the Contact Cover is removed the circuit will show an open until the appliance is installed. The UMB allows for consistent installation and easy replacement of appliances if required. Wall models provide an optional locking screw for extra secure installation, while the ceiling models provide a captivated screw to prevent the screw from falling during installation.

- Save up to **48%** in current draw*
- Up to **9** models now in **1** appliance
- Save up to **14%** cost of installation**

- Sleek Modern Aesthetics
- Finger Slide Switches
- Voltage Test Points
- Multiple Voltages
- 3 Audible Settings
90, 95, 99 dB
- 8 Candela Settings ***
Wall - 15/1575/30/75/95/110/135/185
Ceiling - 15/30/60/75/95/115/150/177
- Universal Mounting Base ***
Ceiling and Wall
Mounts to 5 Backbox Types
- Environmentally Friendly
Low Current Draw

Compatibility and Requirements

- Synchronize using the Wheelock® Sync Modules or panels with built-in Wheelock® Patented Sync Protocol
- Compatible with UL “Regulated Voltage” using filtered VDC or unfiltered VRMS input voltage
- Strobes produce 1 flash per second over the “Regulated Voltage” range

* Compared to competitive models *** Patented
** Compared to previous models

NOTE: All CAUTIONS and WARNINGS are identified by the symbol . All warnings are printed in bold capital letters.

WARNING: PLEASE READ THESE SPECIFICATIONS AND ASSOCIATED INSTALLATION INSTRUCTIONS CAREFULLY BEFORE USING, SPECIFYING OR APPLYING THIS PRODUCT. VISIT WWW.COOPERNOTIFICATION.COM OR CONTACT COOPER NOTIFICATION FOR THE CURRENT INSTALLATION INSTRUCTIONS. FAILURE TO COMPLY WITH ANY OF THESE INSTRUCTIONS, CAUTIONS OR WARNINGS COULD RESULT IN IMPROPER APPLICATION, INSTALLATION AND/OR OPERATION OF THESE PRODUCTS IN AN EMERGENCY SITUATION, WHICH COULD RESULT IN PROPERTY DAMAGE, AND SERIOUS INJURY OR DEATH TO YOU AND/OR OTHERS.

General Notes:

General Notes:

- Strobes are designed to flash at 1 flash per second minimum over their "Regulated Voltage Range".
- All candela ratings represent minimum effective strobe intensity based on UL Standard 1971.
- Series Exceder Strobe products are Listed under UL Standards 1971 and 464 for indoor use with a temperature range of 32°F to 120°F (0°C to 49°C) and maximum humidity of 93% (± 2%) UL 464 (85% UL 1971).
- Series Exceder horns are under UL Standard 464 for audible signal appliances (Indoor use only).

Low Current Draw = Fewer Power Supplies

Strobe Ratings per UL Standard 1971

| | | UL Max Current* | | | | | | | | | | | | | |
|-------|-----------------------------|-----------------|-------|-------|-------|-------|-------|-------|-------|-------|-------|-------|-------|--------|-------|
| | | 24 VDC / 24 FWR | | | | | | | | | | | | 12 VDC | |
| Model | Regulated Voltage Range VDC | 15 | 15/75 | 30 | 60 | 75 | 95 | 110 | 115 | 135 | 150 | 177 | 185 | 15 | 15/75 |
| ST | 8.0-33.0 | 0.057 | 0.070 | 0.085 | | 0.135 | 0.163 | 0.182 | | 0.205 | | | 0.253 | 0.110 | 0.140 |
| STC | 8.0-33.0 | 0.061 | | 0.085 | 0.103 | 0.135 | 0.163 | | 0.182 | | 0.205 | 0.253 | | 0.110 | |

Horn Strobe Ratings per UL 1971 & UL 464 at 24 VDC

| | | UL Max Current* at 99 dBA | | | | | | | | | | | | | |
|-------|-----------------------------|---------------------------|-------|-------|-------|-------|-------|-------|-------|-------|-------|-------|-------|--------|-------|
| | | 24 VDC | | | | | | | | | | | | 12 VDC | |
| Model | Regulated Voltage Range VDC | 15 | 15/75 | 30 | 60 | 75 | 95 | 110 | 115 | 135 | 150 | 177 | 185 | 15 | 15/75 |
| HS | 8.0-33.0 | 0.082 | 0.095 | 0.102 | | 0.148 | 0.176 | 0.197 | | 0.242 | | | 0.282 | 0.125 | 0.159 |
| HSC | 8.0-33.0 | 0.082 | | 0.102 | 0.141 | 0.148 | 0.176 | | 0.197 | | 0.242 | 0.282 | | 0.125 | |

| | | UL Max Current* at 95 dBA | | | | | | | | | | | | | |
|-------|-----------------------------|---------------------------|-------|-------|-------|-------|-------|-------|-------|-------|-------|-------|-------|--------|-------|
| | | 24 VDC | | | | | | | | | | | | 12 VDC | |
| Model | Regulated Voltage Range VDC | 15 | 15/75 | 30 | 60 | 75 | 95 | 110 | 115 | 135 | 150 | 177 | 185 | 15 | 15/75 |
| HS | 8.0-33.0 | 0.073 | 0.083 | 0.087 | | 0.139 | 0.163 | 0.186 | | 0.230 | | | 0.272 | 0.122 | 0.153 |
| HSC | 8.0-33.0 | 0.073 | | 0.087 | 0.128 | 0.139 | 0.163 | | 0.186 | | 0.230 | 0.272 | | 0.122 | |

| | | UL Max Current* at 90 dBA | | | | | | | | | | | | | |
|-------|-----------------------------|---------------------------|-------|-------|-------|-------|-------|-------|-------|-------|-------|-------|-------|--------|-------|
| | | 24 VDC | | | | | | | | | | | | 12 VDC | |
| Model | Regulated Voltage Range VDC | 15 | 15/75 | 30 | 60 | 75 | 95 | 110 | 115 | 135 | 150 | 177 | 185 | 15 | 15/75 |
| HS | 8.0-33.0 | 0.065 | 0.075 | 0.084 | | 0.136 | 0.157 | 0.184 | | 0.226 | | | 0.267 | 0.120 | 0.148 |
| HSC | 8.0-33.0 | 0.065 | | 0.084 | 0.120 | 0.136 | 0.157 | | 0.184 | | 0.226 | 0.267 | | 0.120 | |

Horn Ratings per UL 464

| Model | Regulated Voltage Range VDC | 99 dB | 95 dB | 90 dB |
|-------|-----------------------------|-------|-------|-------|
| HN | 16-33.0 | 0.064 | 0.044 | 0.022 |
| HNC | 16-33.0 | 0.084 | 0.044 | 0.022 |
| HN | 8.0-17.5 | 0.047 | 0.026 | 0.017 |
| HNC | 8.0-17.5 | 0.047 | 0.026 | 0.017 |



* UL max current rating is the maximum RMS current within the listed voltage range (16-33 VDC for 24 VDC units). For strobes the UL max current is usually at the minimum listed voltage (16 VDC for 24 VDC units). For audibles the max current is usually at the maximum listed voltage (33 VDC for 24 VDC units). For unfiltered ratings, see installation instructions.

Specification & Ordering Information

| Model | Strobe Candela | Sync w/ SM, DSM or PS-6 & PS-8 | 12/24 VDC* | Mounting Options |
|---------------------|------------------------------|--------------------------------|------------|------------------|
| Horn Strobes | | | | |
| HSR | 15/1575/30/75/95/110/135/185 | X | X | UMB** |
| HSW | 15/1575/30/75/95/110/135/185 | X | X | UMB** |
| HSRC | 15/30/60/75/95/115/150/177 | X | X | UMB** |
| HSWC | 15/30/60/75/95/115/150/177 | X | X | UMB** |
| Strobes | | | | |
| STR | 15/1575/30/75/95/110/135/185 | X | X | UMB** |
| STW | 15/1575/30/75/95/110/135/185 | X | X | UMB** |
| STRC | 15/30/60/75/95/115/150/177 | X | X | UMB** |
| STWC | 15/30/60/75/95/115/150/177 | X | X | UMB** |
| Horn | | | | |
| HNR | | X | X | UMB** |
| HNW | | X | X | UMB** |
| HNRC | | X | X | UMB** |
| HNWC | | X | X | UMB** |

*12 VDC models feature 15 & 15/75 settings

**UMB = Universal Mounting Base

Model Legend

- HN = Horn
- ST = Strobe
- HS = Horn Strobe
- C = Ceiling Mount
- W = White
- R = Red

Example 1: STRC = Strobe, Red, Ceiling Mount
 Example 2: HSR = Horn Strobe, Red, Wall Mount
 Example 3: HSW = Horn Strobe, White, Wall Mount



Example: HSR



Example: HSWC

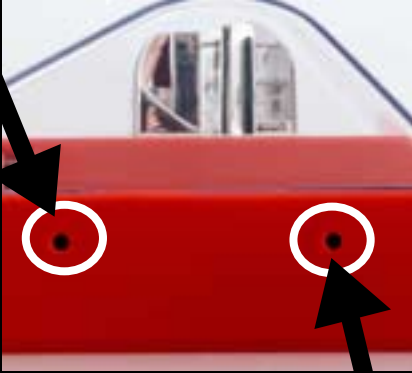

Voltage test points for quick troubleshooting and easy spot checking (wall models only)



8 candela settings



*UMB



Contact Cover

NOTE: Due to continuous development of our products, specifications and offerings are subject to change without notice in accordance with Cooper Wheelock Inc., dba Cooper Notification standard terms and conditions.

Architects and Engineers Specifications

The notification appliances shall be Wheelock® Exceder™ Series HS Audible Strobe appliances, Series ST Visual Strobe appliances and Series HN Audible appliances or approved equals. The Series HS and ST Strobes shall be listed for UL Standard 1971 (Emergency Devices for the Hearing-Impaired) for Indoor Fire Protection Service. The Series HS and HN Audibles shall be UL Listed under Standard 464 (Fire Protective Signaling). All Series shall meet the requirements of FCC Part 15 Class B. All inputs shall be compatible with standard reverse polarity supervision of circuit wiring by a Fire Alarm Control Panel (FACP) with the ability to operate from 8 to 33 VDC. Indoor wall models shall incorporate voltage test points for easy voltage inspection.

The Series HS Audible Strobe and ST Strobe appliances shall produce a flash rate of one (1) flash per second over the Regulated Voltage Range and shall incorporate a Xenon flashtube enclosed in a rugged Lexan® lens. The Series shall be of low current design. Where Multi-Candela appliances are specified, the strobe intensity shall have 8 field selectable settings at 15, 15/75, 30, 75, 95, 110, 135, 185 candela for wall mount and 15, 30, 60, 75, 95, 115, 150, 177 candela for ceiling mount. The selector switch for selecting the candela shall be tamper resistant. The 15/75 candela strobe shall be specified when 15 candela UL Standard 1971 Listing with 75 candela on-axis is required (e.g. ADA compliance). Appliances with candela settings shall show the candela selection in a visible location at all times when installed.

The audible shall have a minimum of three (3) field selectable settings for dBA levels and shall have a choice of continuous or temporal (Code 3) audible outputs.

The Series HS Audible Strobe, ST Strobe and Series HN Audible shall incorporate a patented Universal Mounting Base that shall allow mounting to a single-gang, double-gang, 4-inch square, 3.5-inch octal, 4-inch octal or 100mm European type back boxes. Two wire appliance wiring shall be capable of directly connecting to the mounting base. Continuity checking of the entire NAC circuit prior to attaching any notification appliances shall be allowed. Product shall come with Contact Cover to protect contact springs. Removal of an appliance shall result in a supervision fault condition by the Fire Alarm Control Panel (FACP). The mounting base shall be the same base among all horn, strobe, horn strobe, wall and ceiling models. All notification appliances shall be backwards compatible.

The Series HS and ST wall models shall have a low profile measuring 5.24" H x 4.58" W x 2.19" D. Series HN wall shall measure 5.24" H x 4.58" W x 1.6" D. The Series HSC and STC shall be round and have a low profile with a diameter of 6.68" x 2.63" D. Series HNC ceiling shall have a diameter of 6.68" x 1.50" D.

When synchronization is required, the appliance shall be compatible with Wheelock®'s SM, DSM Sync Modules, Wheelock® Power Supplies or other manufacturer's panels with built-in Wheelock® Patented Sync Protocol. The strobes shall not drift out of synchronization at any time during operation. If the sync protocol fails to operate, the strobe shall revert to a non-synchronized flash-rate and still maintain (1) flash per second over its Regulated Voltage Range. The appliance shall also be designed so that the audible signal may be silenced while maintaining strobe activation when used with Wheelock® synchronization protocol.

Wall Appliances – UL Standard 1971, UL Standard 464, California State Fire Marshal (CSFM), ULC

Ceiling Appliances – UL Standard 1971, UL Standard 464, California State Fire Marshal (CSFM), ULC



WE ENCOURAGE AND SUPPORT NICET CERTIFICATION
3 YEAR WARRANTY

Exceder - Spec Sheet 11/09

NJ Location
273 Branchport Ave.
Long Branch, NJ 07740
P: 800-631-2148
F: 732-222-8707

FL Location
7565 Commerce Ct.
Sarasota, FL 34243
P: 941-487-2300
F: 941-487-2389

VA Location
4401 Wilson Boulevard, Suite 220
Arlington, VA 22203
P: 877-459-7726
F: 703-294-6560

www.coopernotification.com

Cooper Notification is Wheelock®    

 **COOPER**Notification

→ NH-100 Series

Intelligent Addressable Thermal Detectors for FireWarden Series



Addressable

General

The **NOTIFIER NH-100 Series** thermal detectors are addressable sensors that use a state-of-the-art thermistor sensing circuit for fast response. These sensors provide open-area protection and are intended for use with the **FireWarden Series** (FireWarden-100-2 and FireWarden-50) addressable Fire Alarm Control Panels (FACPs).

The **NH-100** and **NH-100R** sensors provide fixed temperature alarm detection at 135°F (57°C). The **NH-100R** sensor also responds to rate-of-rise conditions of greater than 15°F (8.3°C) per minute. The **NH-100H** is a fixed high-temperature detector that activates at 190°F (88°C). These thermal detectors provide addressable property protection in a variety of applications.

Two LEDs on each sensor light to provide a local, visible sensor indication. Remote LED annunciator capability is available as an optional accessory (**RA400Z**).

Features

SLC loop:

- Two-wire SLC loop connection.
- Unit uses base for wiring.

Addressing:

- Addressable by device.
- Direct Decade entry of address: 01 – 99 with FireWarden-100-2, 01 – 50 with FireWarden-50.

Architecture:

- Sleek, low-profile, stylish design.
- State-of-the-art thermistor technology for fast response.
- Integral communications and built-in device-type identification.
- Built-in tamper resistant feature.
- Built-in functional test switch activated by external magnet.

Operation:

- Factory preset at 135°F (57°C) for the NH-100 and NH-100R; 190°F (88°C) for the NH-100H.
- Rate-of-rise triggers at 15°F (8.3°C) per minute for the NH-100R.
- 360°-field viewing angle of the visual alarm indicators (two bicolor LEDs). LEDs blink green in Normal condition and turn on steady red in Alarm.
- Visible LEDs “blink” every time the unit is addressed.

Mechanicals:

- Sealed against back pressure.
- SEMS screws for wiring of the separate base.
- Designed for direct-surface or electrical-box mounting.
- Plugs into separate base for ease of installation and maintenance.
- Separate base allows interchange of photoelectric, ionization and thermal sensors.

Other system features:

- Remote test feature from the panel.
- Walk test with address display.



6936photo1.jp

NH-100 with B710LP base

- Low standby current.
- 94-5V plastic flammability rating.

Options:

- Remote LED output connection to optional RA400Z remote LED annunciator.
- Recessed (**RMK400**) or surface (**SMK400E**) base mounting kits.

Installation

NH-100 Series plug-in intelligent thermal detectors use a detachable base to simplify installation, service and maintenance. Installation instructions are shipped with each detector.

Mount base (all base types) on box that is at least 1.5" (3.81 cm) deep. Suitable boxes include:

- 4.0" (10.16 cm) square box.
- 3.5" (8.89 cm) or 4.0" (10.16 cm) octagonal box.
- Single-gang box (except relay or isolator base).

NOTE: Because of the inherent supervision provided by the SLC loop, end-of-line resistors are not required. Wiring “T-taps” or branches are permitted for Style 4 (Class “B”) wiring only.

Applications

Use thermal detectors for protection of property.

Construction

These detectors are constructed of off-white Bayblend®. The NH-100 Series plug-in intelligent thermal detectors are designed to commercial standards and offer an attractive appearance.

Operation

Each NH-100 Series detector uses one of 99 (FireWarden-100-2) or 50 (FireWarden-50) possible addresses on a control panel SLC loop. It responds to regular polls from the control panel and reports its type and the status. If it receives a test command from the panel (or a local magnet test), it stimulates its electronics and reports an alarm. It blinks its LEDs when polled and turns the LEDs on when commanded by the panel.

The NH-100 Series offers features and performance that represent the latest in thermal detector technology.

Specifications

Diameter: 6.1" (15.5 cm) installed in B710LP.

Height: 2.1" (5.33 cm).

Weight: 4.8 oz. (137 g).

Installation temperature:

- NH-100, NH-100R: -4°F to 100°F (-20°C to 38°C).
- NH-100H: -4°F to 150°F (-20°C to 66°C).

Humidity range: 10% to 93% relative humidity (noncondensing).

Voltage range: 15 to 32 VDC peak.

Standby current: 300 μ A @ 24 VDC (one communication every five seconds with LED blink enabled).

LED current: 6.5 mA @ 24 VDC.

Mounting: B710LP flanged base, included.

Fixed-temperature setpoint: 135°F (57°C) for the NH-100 and NH-100R; 190°F (88°C) for the NH-100H.

Rate-of-rise detection: responds to greater than 15°F (8.3°C) per minute.

Altitude rating: 10,000 feet.

Listings and Approvals

Listings and approvals below apply to the NH-100 Series detectors. In some cases, certain modules may not be listed by certain approval agencies, or listing may be in process. Consult factory for latest listing status.

- UL Listed, file S747.
- CSFM approved: file 7270-0028:234.
- MEA approved: file 387-02-E Vol. II.
- FM approved.

Product Line Information



NH-100: Intelligent thermal sensor; 135° F (57° C) B710LP base included.

NH-100R: Same as NH-100 with *rate-of-rise* feature; B710LP base included.

NH-100H: Intelligent fixed high-temperature thermal detector; 190° F (88° C) B710LP base included.

B710LP: Plug-in detector base (included). **Dimensions:** 6.1" (15.5 cm). **Mounting:** 4.0" (10.16 cm) square box with or without plaster ring, 4.0" (10.16 cm) octagonal box, 3.5" (8.89 cm) octagonal box, or single-gang box. All mounting boxes have a minimum depth of 1.5" (3.81 cm).

B224RB: Plug-in System Sensor *relay* detector base. **Diameter:** 6.2" (15.75 cm). **Mounting:** 4.0" (10.16 cm) square box with or without plaster ring, 4.0" (10.16 cm) octagonal box, or 3.5" (8.89 cm) octagonal box. All mounting boxes have a minimum depth of 1.5" (3.81 cm).

B224BI: Plug-in System Sensor *isolator* detector base. Maximum 25 devices between isolator bases (*see DN-6994*). **Diameter:** 6.2" (15.75 cm). **Mounting:** 4.0" (10.16 cm) square

box with or without plaster ring, 4.0" (10.16 cm) octagonal box, or 3.5" (8.89 cm) octagonal box. All mounting boxes have a minimum depth of 1.5" (3.81 cm).

B501BH-2: Plug-in System Sensor standard *sounder* base. **Diameter:** 6.0" (15.24 cm). **Mounting:** 4.0" (10.16 cm) square box with or without plaster ring. Mounting boxes have a minimum depth of 1.5" (3.81 cm).

B501BHT-2: Plug-in System Sensor *temporal tone* sounder base.

ACCESSORIES:

RA400Z: Remote LED annunciator. 3 – 32 VDC. Mounts to a U.S. single-gang electrical box. For use with B501 and B710LP bases only.

SMK400E: Surface mounting kit provides for entry of surface wiring conduit. For use with B501 base only.

RMK400: Recessed mounting kit. For use with B501 base only.

M02-04-00: Test magnet.

M02-09-00: Test magnet with telescoping handle.

XR2B: Detector removal tool. Allows installation and/or removal of detector heads from bases in high ceiling applications.

XP-4: Extension pole for XR2B. Comes in three 5-foot (1.524 m) sections.

NOTIFIER® is a registered trademark of Honeywell International Inc. Bayblend® is a registered trademark of Bayer Corp. ©2009. All rights reserved. Unauthorized use of this document is strictly prohibited.



This document is not intended to be used for installation purposes.
We try to keep our product information up-to-date and accurate.
We cannot cover all specific applications or anticipate all requirements.
All specifications are subject to change without notice.



Made in the U.S. A.

For more information, contact Notifier. Phone: (203) 484-7161, FAX: (203) 484-7118.
www.notifier.com

→ 5600 Series

Mechanical Heat Detectors



Conventional Initiating Devices

GENERAL

System Sensor's 5600 Series mechanical heat detectors offer property protection against fire and for non-life-safety installations, where smoke detectors are inappropriate.

Multiple configurations. The 5600 Series offers a full line of configurations to accommodate a broad range of applications. Both single- and dual-circuit models are offered, each available for low- and high-temperature ratings with either fixed-temperature or combination fixed-temperature/rate-of-rise (ROR) activation. The ROR element of the fixed/ROR models is restorable, to accommodate field-testing the unit.

Installation flexibility. To satisfy a variety of installations, the 5600 Series easily mounts to single-gang and octagonal backboxes. These models also accommodate 4" (101.6 mm) square backboxes when used with a plaster ring. The mounting bracket is reversible to allow for flush- and surface-mount backbox installations.

Visual identification. The 5600 Series provides clear markings on the exterior of the unit to ensure that the proper detector is being used. Alphanumeric characters identify the activation method, as well as the temperature rating, in degrees Fahrenheit and Celsius. Fixed temperature models are identified "FX", while combination fixed/rate-of-rise units are marked "FX/ROR". The 5600 Series also provides a collector as a post-activation indicator. Once the detector has been activated, the collector drops from the unit to allow easy identification of the specific unit in alarm.

FEATURES

- Multiple configurations available:
 - Fixed-temperature (non-resettable) or combination fixed (non-resettable)/rate-of-rise (self-restoring).
 - Low-temperature and high-temperature ratings.
 - Single-circuit and dual-circuit.
- Easy-to-read alphanumeric identification of detector type and temperature rating.
- External collector provides visual indication of activation.
- Reversible mounting bracket for flush- and surface-mount installations.
- Flexible mounting capabilities: single-gang, 3.5" or 4" octagonal, 4" (101.6 mm) square with plaster ring.
- Easy-to-use terminal screws provide a more positive wiring connection.
- Low-profile design to coordinate with room aesthetics.

AGENCY LISTINGS AND APPROVALS

These listings and approvals apply to the modules specified in this document. In some cases, certain modules or applications may not be listed by certain approval agencies, or listing may be in process. Consult factory for latest listing status.

- **UL Listed:** S2101
- **ULC Listed:** S2101 (all with "A" suffix)
- **MEA:** 199-03-E
- **CSFM:** 7270-1209:227, 7270-1653:167
- **FM Approved**



6931ph01.jpg

SPECIFICATIONS

PHYSICAL SPECIFICATIONS

Maximum installation temperature:

For models 5601P, 5603, 5621, 5623: 100°F (38°C).

For models 5602, 5604, 5622, 5624: 150°F (65.6°C).

Alarm temperature:

For models 5601P, 5603, 5621, 5623: 135°F (57°C).

For models 5602, 5604, 5622, 5624: 194°F (90°C).

Rate-of-Rise Threshold: 15°F (8.3°C) per minute (models 5601, 5602, 5621, 5622 only).

Operating Humidity Range: 5% to 95% RH noncondensing.

Input Terminals: non-polarized, accept 14 to 22 AWG (2.0 to 0.33 mm²).

Dimensions: diameter with mounting bracket: 4.57" (116 mm); height with mounting bracket: 1.69" (43 mm).

Weight: 6 oz. (170 grams).

Mounting Options: 3.5" (88.9 mm) octagonal backbox; 4" (101.6 mm) octagonal backbox; single-gang backbox; 4" (101.6 mm) square backbox with a square-to-round plaster ring.

ELECTRICAL SPECIFICATIONS

| Operating Voltage | Contact Ratings (resistive) |
|-------------------|-----------------------------|
| 6 - 125 VAC | 3.0 A |
| 6 - 28 VDC | 1.0 A |
| 125 VDC | 0.3 A |
| 250 VDC | 0.1 A |

Mechanical heat detector shall be a System Sensor 5600 Series model number _____, Listed to Underwriters Laboratories UL 521 for Heat Detectors for Fire Protective Signaling Systems. The detector shall be either a single-circuit or a dual-circuit type, normally open. The detector shall be rated for activation at either 135°F (57°C) or 194°F (90°C), and shall activate by means of a fixed-temperature thermal sensor, or a combination fixed-temperature/rate-of-rise thermal sensor. The rate-of-rise element shall be activated by a rapid rise in temperature, approximately 15°F (8.3°C) per minute. The detector shall include a reversible mounting bracket for mount-

ing to 3.5-inch (88.9 mm) octagonal, 4-inch (101.6 mm) octagonal, single gang, and 4-inch (101.6 mm) square backboxes with a square-to-round plaster ring. Wiring connections shall be made by means of SEMS screws that shall accommodate 14 – 22 AWG wire. The detector shall contain alphanumeric markings on the exterior of the housing to identify its tempera-

ture rating and activation method. The rate-of-rise element of combination fixed-temperature/rate-of-rise models shall be restorable, to allow for field-testing. The detectors shall include an external collector that shall drop upon activation to identify the unit in alarm.

ORDERING INFORMATION

| Model* | Identification Method on Exterior | Circuit | Temperature Rating | Activation | UL Protected Spacing, 10' (3.048 m) Ceiling* |
|---------|-----------------------------------|---------|--------------------|--------------------------------|--|
| → 5601P | None | Single | 135°F (57°C) | Fixed-Temperature/Rate-of-Rise | 50 ft. x 50 ft. (15.24 m x 15.24 m) |
| 5602 | Lettering | Single | 194°F (90°C) | Fixed-Temperature/Rate-of-Rise | 50 ft. x 50 ft. (15.24 m x 15.24 m) |
| 5603 | Lettering | Single | 135°F (57°C) | Fixed-Temperature | 25 ft. x 25 ft. (7.62 m x 7.62 m) |
| 5604 | Lettering | Single | 194°F (90°C) | Fixed-Temperature | 25 ft. x 25 ft. (7.62 m x 7.62 m) |
| 5621 | Lettering | Dual | 135°F (57°C) | Fixed-Temperature/Rate-of-Rise | 50 ft. x 50 ft. (15.24 m x 15.24 m) |
| 5622 | Lettering | Dual | 194°F (90°C) | Fixed-Temperature/Rate-of-Rise | 50 ft. x 50 ft. (15.24 m x 15.24 m) |
| 5623 | Lettering | Dual | 135°F (57°C) | Fixed-Temperature | 25 ft. x 25 ft. (7.62 m x 7.62 m) |
| 5624 | Lettering | Dual | 194°F (90°C) | Fixed-Temperature | 25 ft. x 25 ft. (7.62 m x 7.62 m) |

NOTE: Refer to NFPA 72 guidelines for spacing reductions when ceiling heights exceed 10 feet (3.048 m).

* Add an "A" to part number for ULC model.

WIRING DIAGRAMS

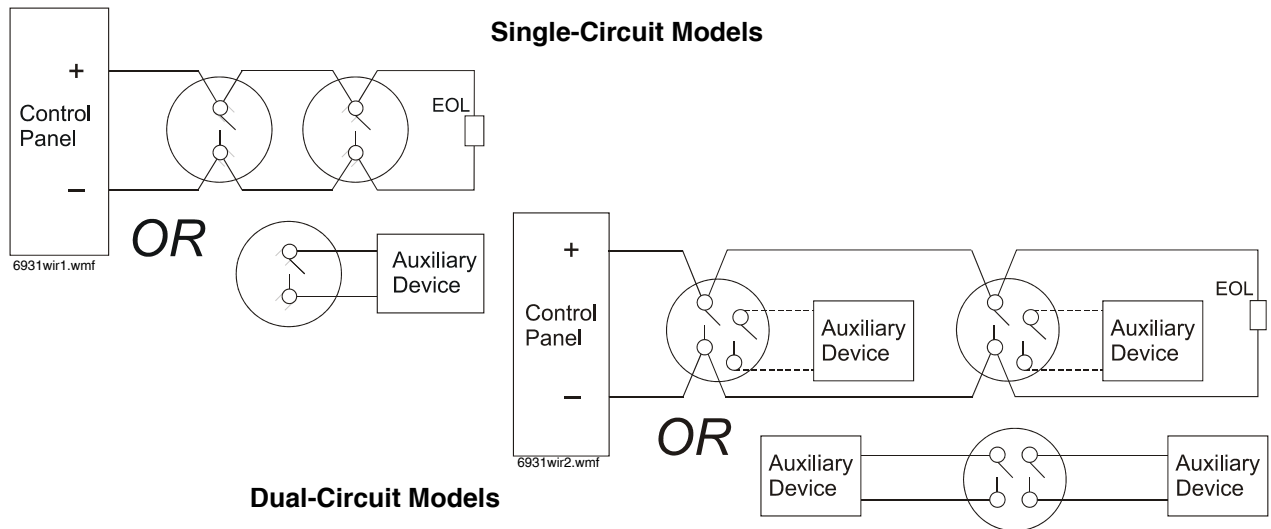

©2010 by Honeywell International Inc. All rights reserved. Unauthorized use of this document is strictly prohibited.



This document is not intended to be used for installation purposes. We try to keep our product information up-to-date and accurate. We cannot cover all specific applications or anticipate all requirements. All specifications are subject to change without notice.



For more information, contact Notifier. Phone: (203) 484-7161, FAX: (203) 484-7118. www.notifier.com

Monitor Modules

→ NMM-100(A), NMM-100P(A), NZM-100(A), and NDM-100(A) for FireWarden Series Panels



Intelligent Addressable Devices

General

Four different monitor modules are available for Notifier's FireWarden Series intelligent control panels for a variety of applications. Monitor modules supervise a circuit of dry-contact input devices, such as conventional heat detectors and pull stations, or monitor and power a circuit of two-wire smoke detectors (NZM-100(A)).

→ **NMM-100(A)** is a standard-sized module (typically mounts to a 4" [10.16 cm] square box) that supervises either a Style D (Class A) or Style B (Class B) circuit of dry-contact input devices.

NMM-100P(A) is a miniature monitor module a mere 1.3" (3.302 cm) H x 2.75" (6.985 cm) W x 0.5" (1.270 cm) D that supervises a Style B (Class B) circuit of dry-contact input devices. Its compact design allows the NMM-100P(A) to be mounted in a single-gang box behind the device it monitors.

NZM-100(A) is a standard-sized module that monitors and supervises compatible two-wire, 24 volt, smoke detectors on a Style D (Class A) or Style B (Class B) circuit.

NDM-100(A) is a standard-sized dual monitor module that monitors and supervises two independent two-wire Style B (Class B) dry-contact initiating device circuits (IDCs) at two separate, consecutive addresses in intelligent, two-wire systems.

→ NMM-100(A) Monitor Module

- Built-in type identification automatically identifies this device as a monitor module to the control panel.
- Powered directly by two-wire SLC loop. No additional power required.
- High noise (EMF/RFI) immunity.
- SEMS screws with clamping plates for ease of wiring.
- Direct Decade entry of address: 01 – 99 on FireWarden-100-2, 01 – 50 on FireWarden-50.
- LED flashes during normal operation and latches on steady to indicate alarm.

The NMM-100(A) Monitor Module is intended for use in intelligent, two-wire systems, where the individual address of each module is selected using the built-in rotary switches. It provides either a two-wire or four-wire fault-tolerant Initiating Device Circuit (IDC) for normally-open-contact fire alarm and supervisory devices. The module has a panel-controlled LED indicator.

NMM-100(A) APPLICATIONS

Use to monitor a zone of four-wire smoke detectors, manual fire alarm pull stations, waterflow devices, or other normally-open dry-contact alarm activation devices. May also be used to monitor normally-open supervisory devices with special supervisory indication at the control panel. Monitored circuit may be wired as an NFPA Style B (Class B) or Style D (Class A) Initiating Device Circuit. A 47K ohm End-of-Line Resistor (provided) terminates the Style B circuit. No resistor is required for supervision of the Style D circuit.



NMM-100(A) (Type H)

NMM-100(A) OPERATION

Each NMM-100(A) uses one of the available module addresses on an SLC loop. It responds to regular polls from the control panel and reports its type and the status (open/normal/short) of its Initiating Device Circuit (IDC). A flashing LED indicates that the module is in communication with the control panel. The LED latches steady on alarm (subject to current limitations on the loop).

NMM-100(A) SPECIFICATIONS

Nominal operating voltage: 15 to 32 VDC.

Maximum current draw: 5.0 mA (LED on).

Average operating current: 350 μ A (LED flashing), 1 communication every 5 seconds, 47k EOL.

Maximum IDC wiring resistance: 40 ohms.

EOL resistance: 47K ohms.

Temperature range: 32°F to 120°F (0°C to 49°C).

Humidity range: 10% to 93% noncondensing.

Dimensions: 4.5" (11.43 cm) high x 4" (10.16 cm) wide x 1.25" (3.175 cm) deep. Mounts to a 4" (10.16 cm) square x 2.125" (5.398 cm) deep box.

NMM-100P(A) Mini Monitor Module

- Built-in type identification automatically identifies this device as a monitor module to the panel.
- Powered directly by two-wire SLC loop. No additional power required.
- High noise (EMF/RFI) immunity.
- Tinned, stripped leads for ease of wiring.
- Direct Decade entry of address: 01 – 99 on FireWarden-100-2, 01 – 50 on FireWarden-50.

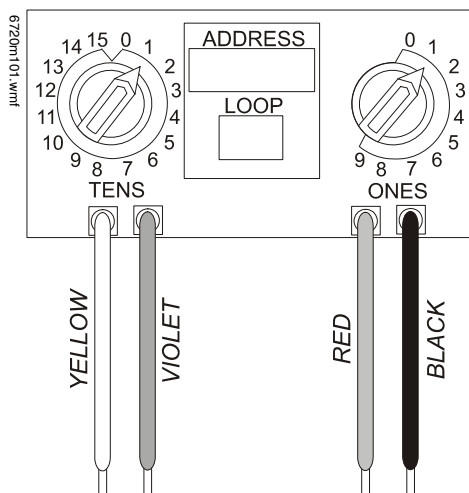

The NMM-100P(A) Mini Monitor Module can be installed in a single-gang junction directly behind the monitored unit. Its small size and light weight allow it to be installed without rigid mounting. The NMM-100P(A) is intended for use in intelligent, two-wire systems where the individual address of each module is selected using rotary switches. It provides a two-wire initiating device circuit for normally-open-contact fire alarm and security devices. NMM-100P(A)

NMM-100P(A) APPLICATIONS

Use to monitor a single device or a zone of four-wire smoke detectors, manual fire alarm pull stations, waterflow devices, or other normally-open dry-contact devices. May also be used to monitor normally-open supervisory devices with special supervisory indication at the control panel. Monitored circuit/device is wired as an NFPA Style B (Class B) Initiating Device Circuit. A 47K ohm End-of-Line Resistor (provided) terminates the circuit.

NMM-100P(A) OPERATION

Each NMM-100P(A) uses one of the available module addresses on an SLC loop. It responds to regular polls from the control panel and reports its type and the status (open/normal/short) of its Initiating Device Circuit (IDC).

NMM-100P(A) SPECIFICATIONS

Nominal operating voltage: 15 to 32 VDC.

Average operating current: 350 μ A, 1 communication every 5 seconds, 47k EOL; 600 μ A Max. (Communicating, IDC Shorted).

Maximum IDC wiring resistance: 40 ohms.

Maximum IDC Voltage: 11 Volts.

Maximum IDC Current: 400 μ A.

EOL resistance: 47K ohms.

Temperature range: 32°F to 120°F (0°C to 49°C).

Humidity range: 10% to 93% noncondensing.

Dimensions: 1.3" (3.302 cm) high x 2.75" (6.985 cm) wide x 0.65" (1.651 cm) deep.

Wire length: 6" (15.24 cm) minimum.

NZM-100(A) Interface Module

- Supports compatible two-wire smoke detectors.
- Supervises IDC wiring and connection of external power source.
- High noise (EMF/RFI) immunity.
- SEMS screws with clamping plates for ease of wiring.
- Direct Decade entry of address: 01 – 99 on FireWarden-100-2, 01 – 50 on FireWarden-50.
- LED flashes during normal operation.
- LED latches steady to indicate alarm on command from control panel.

The NZM-100(A) Interface Module is intended for use in intelligent, addressable systems, where the individual address of each module is selected using built-in rotary switches. This module allows intelligent panels to interface and monitor two-wire conventional smoke detectors. It transmits the status (normal, open, or alarm) of one full zone of conventional detectors back to the control panel. All two-wire detectors being monitored must be UL compatible with the module.

NZM-100(A) APPLICATIONS

Use the NZM-100(A) to monitor a zone of two-wire smoke detectors. The monitored circuit may be wired as an NFPA Style B (Class B) or Style D (Class A) Initiating Device Circuit. A 3.9 K ohm End-of-Line Resistor (provided) terminates the end of the Style B or D (class B or A) circuit (maximum IDC loop resistance is 25 ohms). Install ELR across terminals 8 and 9 for Style D application.

NZM-100(A) OPERATION

Each NZM-100(A) uses one of the available module addresses on an SLC loop. It responds to regular polls from the control panel and reports its type and the status (open/normal/short) of its Initiating Device Circuit (IDC). A flashing LED indicates that the module is in communication with the control panel. The LED latches steady on alarm (subject to current limitations on the loop).

NZM-100(A) SPECIFICATIONS

Nominal operating voltage: 15 to 32 VDC.

Maximum current draw: 5.1 mA (LED on).

Maximum IDC wiring resistance: 25 ohms.

Average operating current: 300 μ A, 1 communication and 1 LED flash every 5 seconds, 3.9k eol.

EOL resistance: 3.9K ohms.

External supply voltage (between Terminals T3 and T4): DC voltage: 24 volts power limited. Ripple voltage: 0.1 Vrms maximum. Current: 90 mA per module maximum.

Temperature range: 32°F to 120°F (0°C to 49°C).

Humidity range: 10% to 93% noncondensing.

Dimensions: 4.5" (11.43 cm) high x 4" (10.16 cm) wide x 1.25" (3.175 cm) deep. Mounts to a 4" (10.16 cm) square x 2.125" (5.398 cm) deep box.

NDM-100(A) Dual Monitor Module

The NDM-100(A) Dual Monitor Module is intended for use in intelligent, two-wire systems. It provides two independent two-wire initiating device circuits (IDCs) at two separate, consecutive addresses. It is capable of monitoring normally open contact fire alarm and supervisory devices. The module has a single panel-controlled LED.

NOTE: The NDM-100(A) provides two Style B (Class B) IDC circuits ONLY. Style D (Class A) IDC circuits are NOT supported in any application.

NDM-100(A) SPECIFICATIONS

Normal operating voltage range: 15 to 32 VDC.

Maximum current draw: 6.4 mA (LED on).

Average operating current: 750 μ A (LED flashing).

Maximum IDC wiring resistance: 1,500 ohms.

Maximum IDC Voltage: 11 Volts.

Maximum IDC Current: 240 μ A

EOL resistance: 47K ohms.

Maximum SLC Wiring resistance: 40 Ohms.

Temperature range: 32° to 120°F (0° to 49°C).

Humidity range: 10% to 93% (non-condensing).

Dimensions: 4.5" (11.43 cm) high x 4" (10.16 cm) wide x 2.125" (5.398 cm) deep.

NDM-100(A) AUTOMATIC ADDRESSING

The NDM-100(A) automatically assigns itself to two addressable points, starting with the original address. For example, if the NDM-100(A) is set to address "26", then it will automatically assign itself to addresses "26" and "27".

NOTE: "Ones" addresses on the NDM-100(A) are 0, 2, 4, 6, or 8 only. Terminals 6 and 7 use the first address, and terminals 8 and 9 use the second address.



CAUTION:

Avoid duplicating addresses on the system.

Installation

NMM-100(A), NZM-100(A), and NDM-100(A) modules mount directly to a standard 4" (10.16 cm) square, 2.125" (5.398 cm) deep, electrical box. They may also be mounted to the SMB500 surface-mount box. Mounting hardware and installation instructions are provided with each module. All wiring must conform to applicable local codes, ordinances, and regulations. These modules are intended for power-limited wiring only.

The NMM-100P(A) module is intended to be wired and mounted without rigid connections inside a standard electrical box. All wiring must conform to applicable local codes, ordinances, and regulations.

Agency Listings and Approvals

In some cases, certain modules may not be listed by certain approval agencies, or listing may be in process. Consult factory for latest listing status.

- **UL:** S635
- **ULC:** S635
- **FM Approved**
- **CSFM:** 7300-0028:0230 (NMM-100, NMM-100P, NZM-100); 7300-0028:0237 (NDM-100)

- **MEA:** 72-01-E Vol. 2 (NMM-100, NMM-100P, NZM-100); 227-03-E Vol. 3 (NDM-100)

Product Line Information

NOTE: "A" suffix indicates ULC-listed model.

NMM-100(A): Monitor module.

NMM-100P(A): Monitor module, miniature.

NZM-100(A): Monitor module, two-wire detectors.

NDM-100(A): Monitor module, dual, two independent Class B circuits.

SMB500: Optional surface-mount backbox.

NOTE: See installation instructions and refer to the SLC Wiring Manual, PN 52304.

Notifier® and FireWarden® are registered trademarks and FireWatch™ is a trademark of Honeywell International Inc.
©2010 by Honeywell International Inc. All rights reserved. Unauthorized use of this document is strictly prohibited.



This document is not intended to be used for installation purposes.
We try to keep our product information up-to-date and accurate.
We cannot cover all specific applications or anticipate all requirements.
All specifications are subject to change without notice.



Made in the U.S. A.

For more information, contact Notifier. Phone: (203) 484-7161, FAX: (203) 484-7118.
www.notifier.com



System Current Draw - NFW-50

| Current Draw | |
|--------------|----------------|
| C1 | 0.164 A |
| C2 | 1.132 A |
| C3 | 0.142 A |

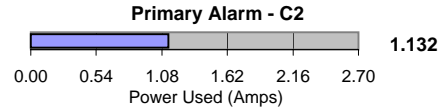
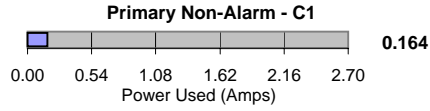

| Device | C1 - Non-Alarm Current | | | | C2 - Alarm Current | | | | C3 - Standby Current | | | | | |
|---|------------------------|---|---------|--------------|--------------------------|---|---------|---------|----------------------|----------------------------|---------|---------|--|--------------|
| | Qty | | Draw | Non-Alarm | Qty | | Draw | Alarm | Qty | | Draw | Standby | | |
| Main Circuit Board | 1 | x | 0.12000 | 0.12000 | 1 | x | 0.20000 | 0.20000 | 1 | x | 0.12000 | 0.12000 | | |
| HSW15 | 6 | x | 0.00000 | 0.00000 | 6 | x | 0.08200 | 0.49200 | 6 | x | 0.00000 | 0.00000 | | |
| N-ANN-80 | 1 | x | 0.03700 | 0.03700 | 1 | x | 0.04000 | 0.04000 | 1 | x | 0.01500 | 0.01500 | | |
| NP-100 | 6 | x | 0.00030 | 0.00180 | | | | | 6 | x | 0.00030 | 0.00180 | | |
| NH-100 | 4 | x | 0.00030 | 0.00120 | | | | | 4 | x | 0.00030 | 0.00120 | | |
| NMM-100 | 6 | x | 0.00040 | 0.00240 | | | | | 6 | x | 0.00040 | 0.00240 | | |
| NOT-BG12LX | 9 | x | 0.00023 | 0.00207 | | | | | 9 | x | 0.00023 | 0.00207 | | |
| Max Alarm Draw - All Addressable Devices | | | | | 1 | x | 0.40000 | 0.40000 | | | | | | |
| Total Non-Alarm Load: | | | | 0.164 | Total Alarm Load: | | | | 1.132 | Total Standby Load: | | | | 0.142 |



System Power Requirements

NFW-50 Fire Alarm Control Panel

| | |
|---|---------------------------------------|
| Protected Premises: <u>125 Morning Street</u> | Date: <u>5/24/2011</u> |
| Address: <u>125 Morning street</u> | |
| City: <u>Portland</u> | State: <u>Maine</u> Zip: _____ |
| Prepared By: <u>Norris Inc.</u> | Phone: _____ |
| Address: <u>2257 West Broadway</u> | Email: _____ |
| City: <u>South Portland</u> | State: <u>Maine</u> Zip: <u>04106</u> |

AC Branch Current Requirements 3.00 AMPS @ 120 VAC

Current required by source to power the fire alarm system.

Primary Standby Load 0.16 Amps

Current load on the primary power supply during **non-alarm** conditions.

Primary Alarm Load 1.13 Amps

Current load on the primary power supply during **alarm** conditions.

Secondary Load Requirements 4.44 Amp Hours

Total Secondary Load from the calculation table below.

| Current Draw | | Time (hours) | Total (AH) |
|---|---|-----------------------------|-------------|
| Secondary Standby Load 0.142 A | x | Required Standby Time | |
| | | 24 hours | 3.42 |
| Secondary Alarm Load 1.132 A | x | Required Alarm Time (hours) | |
| | | 15 Minutes 0.250 hours | 0.28 |
| Auxiliary Power Supply Load 0.000 A | x | Required Alarm Time (hours) | |
| | | 0.250 hours | 0.00 |
| Total Secondary Load | | | 3.70 |
| Derating factor | | | x 1.2 |
| Secondary Load Requirements | | | 4.44 |

AH

Battery Selection 7 Amp Hours

Select batteries from the list below.

7.0 AH BAT-1270 Battery (12 volt)

- Two Four (two 12VDC sets in parallel)

Battery Distribution Chart

Shows amp-hour distribution of your selections.

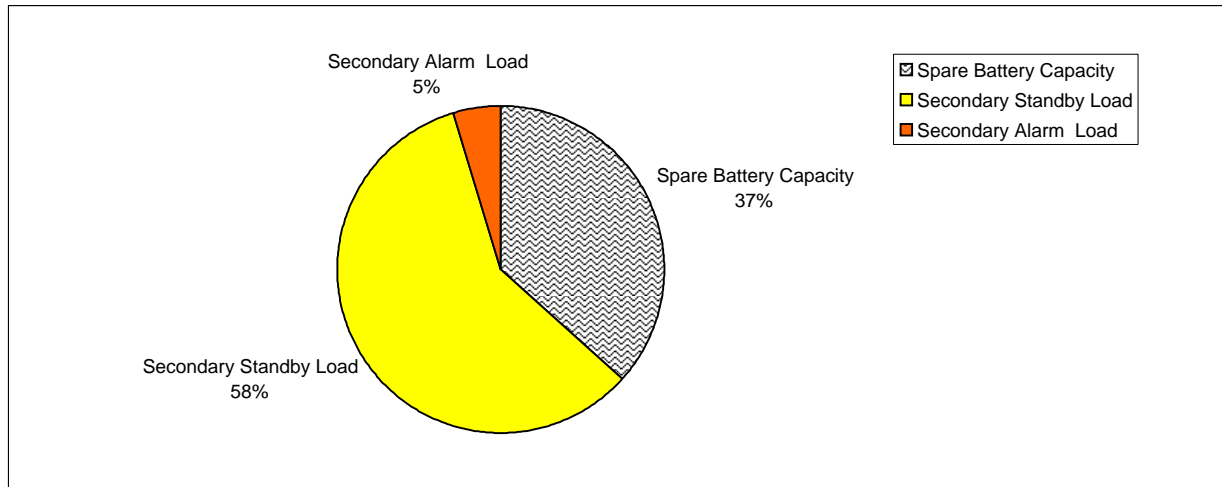

Comments

1. Batteries will fit in the FACP cabinet.
2. Selected battery size meets secondary load requirements.
3. The selected batteries (7AH) are within the charger range of this power supply (7-18AH).

| | | |
|------------------------|------|---|
| Spare Battery Capacity | 2.56 | Battery Selection (AH) - Secondary Load Requirements (AH) |
| Secondary Standby Load | 4.10 | Secondary Standby Load (AH) * Derating Factor |
| Secondary Alarm Load | 0.34 | Secondary Alarm Load (AH) * Derating Factor |

CELLAR

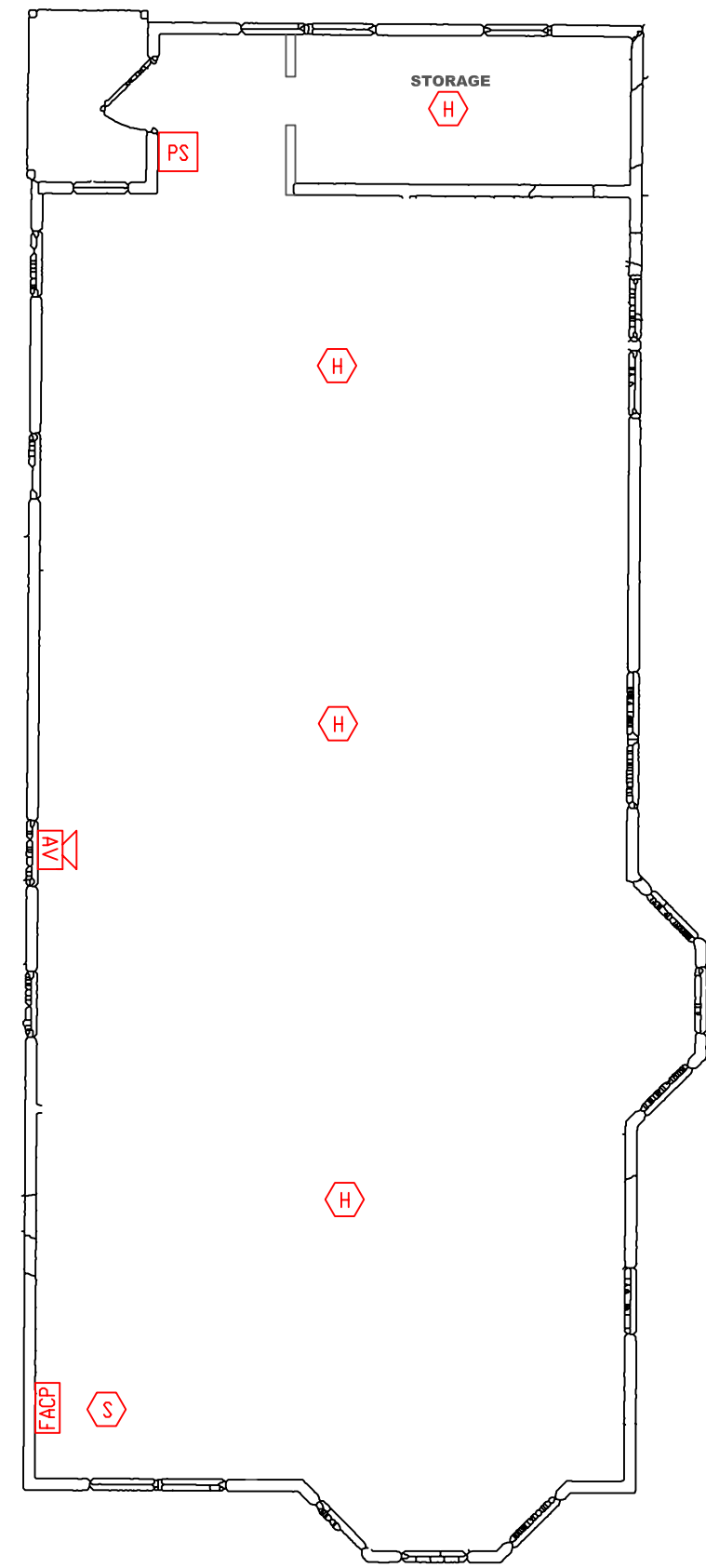

FIRST FLOOR

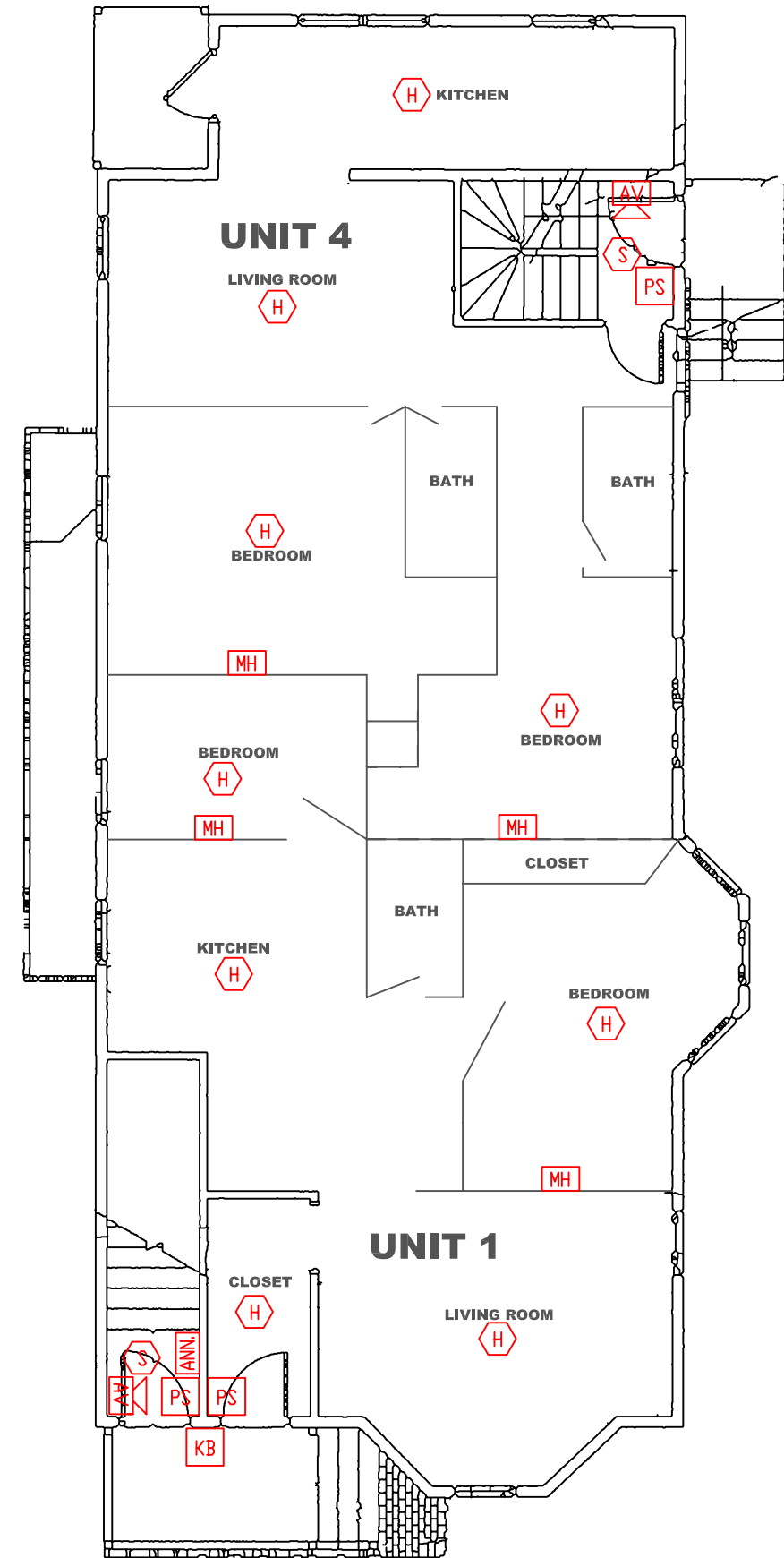

SECOND FLOOR

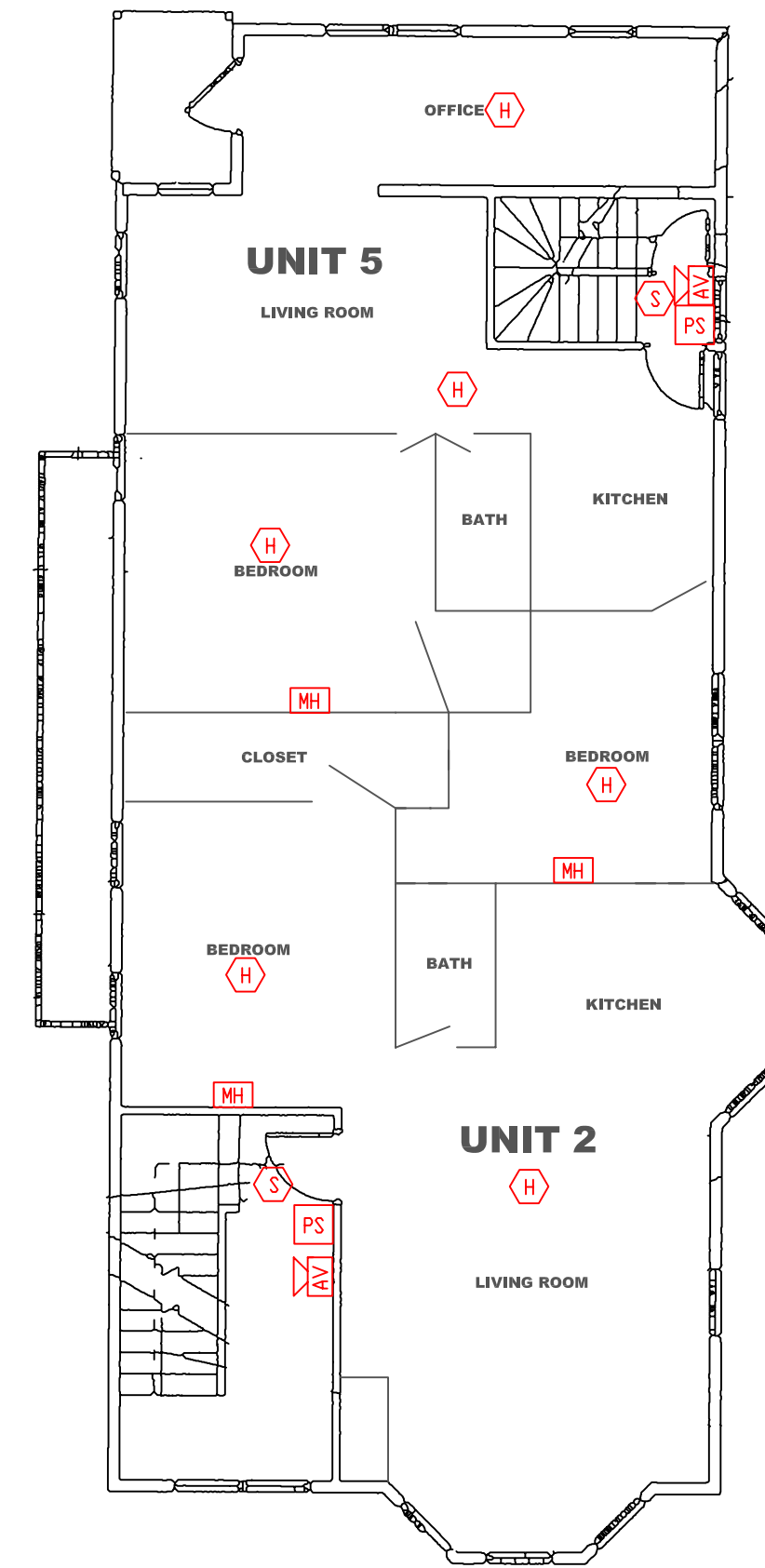

LEGEND

| | | |
|-----------|---------|--|
| 80 INCHES | PS | PULL STATION |
| 80 INCHES | S | SMOKE DETECTOR |
| 80 INCHES | H | HEAT DETECTOR RATE OF RISE |
| 80 INCHES | VO | VISUAL ONLY |
| 80 INCHES | AV | AUDIO / VISUAL |
| 80 INCHES | VO | VISUAL ONLY |
| | NZM 100 | ZONE MODULE |
| | NC-100 | CONTROL MODULE |
| | NMM | MONITOR MODULE 100=4 SQUARE, 100p=minimod |
| | NC 100r | RELAY MODULE |
| | STS | SPRINKLER TAMPER |
| | SFS | SPRINKLER FLOW |

This drawing is an accurate layout from provided floor plans and information available at time of design. Circuiting has been designed for maximum use of resources available with supplied equipment. Deviations from this design must be noted and approved prior to final acceptance. Note: There are 2 signal circuits have a combined load limitation of 2.5 amps. REMOTE power supply has a 3.0 amps limitation per circuit and an 8.0 amp combined limitation for all 4 circuits. Changes in circuiting must incorporate equipment specifications/limitations(see chart below for current vs. candle rating. Distances and ratings shown are from wall applications ONLY, call Norris, Inc. for ceiling devices when applicable.) Twisted-Unshielded Cable is NDT recommended for SLC wiring for this panel. Untwisted-Unshielded cable has a 2500' maximum distance either inside or outside conduit sizes 12-18AWG

| Room Size | Candela Rating | Load (amps) |
|-----------|----------------|-------------|
| 20' x 20' | 15 cd | 0.08 amps |
| 28' x 28' | 30 cd | 0.10 amps |
| 45' x 45' | 75 cd | 0.15 amps |
| 54' x 54' | 110 cd | 0.20 amps |

THIRD FLOOR

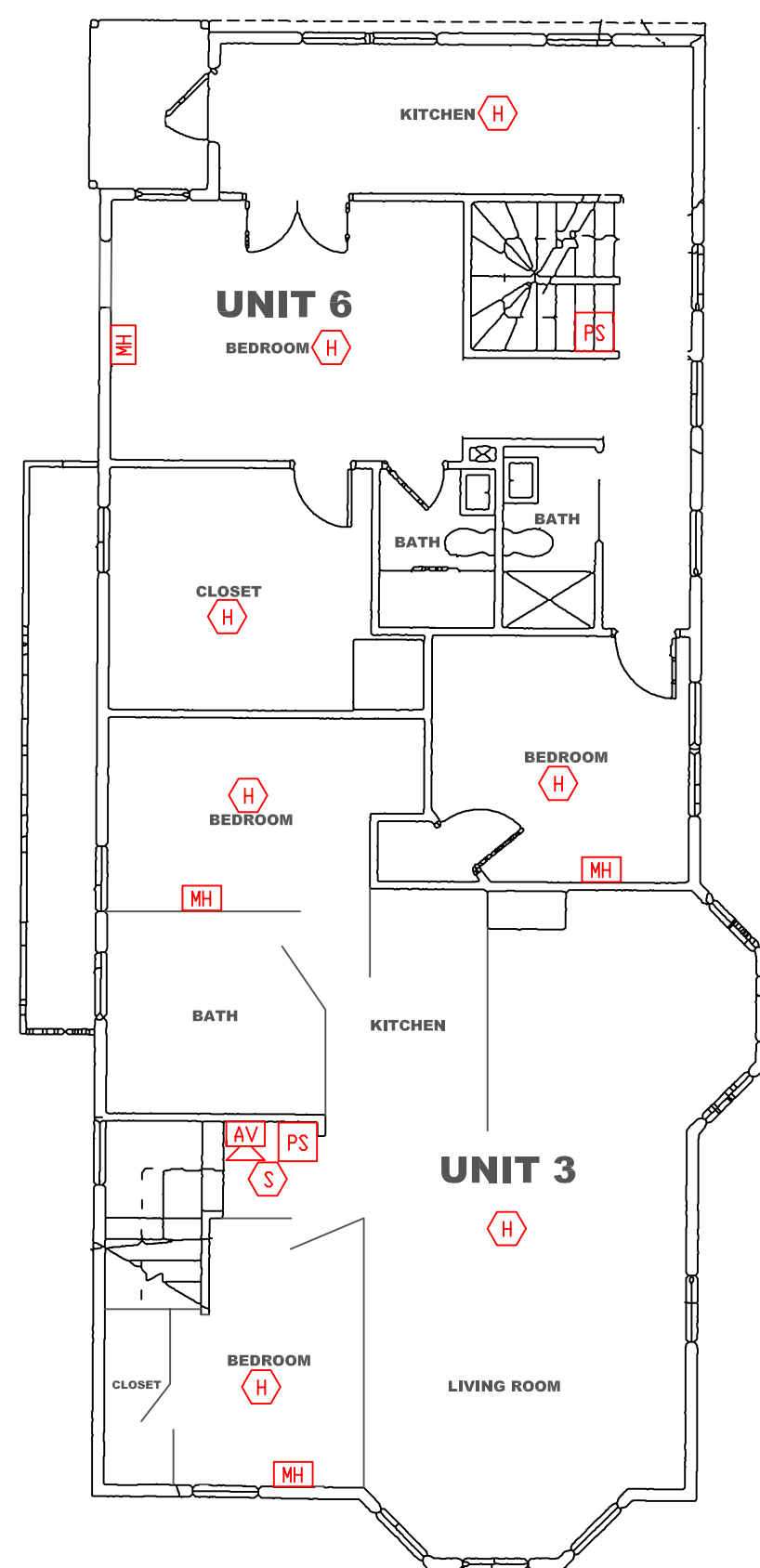

FOURTH FLOOR

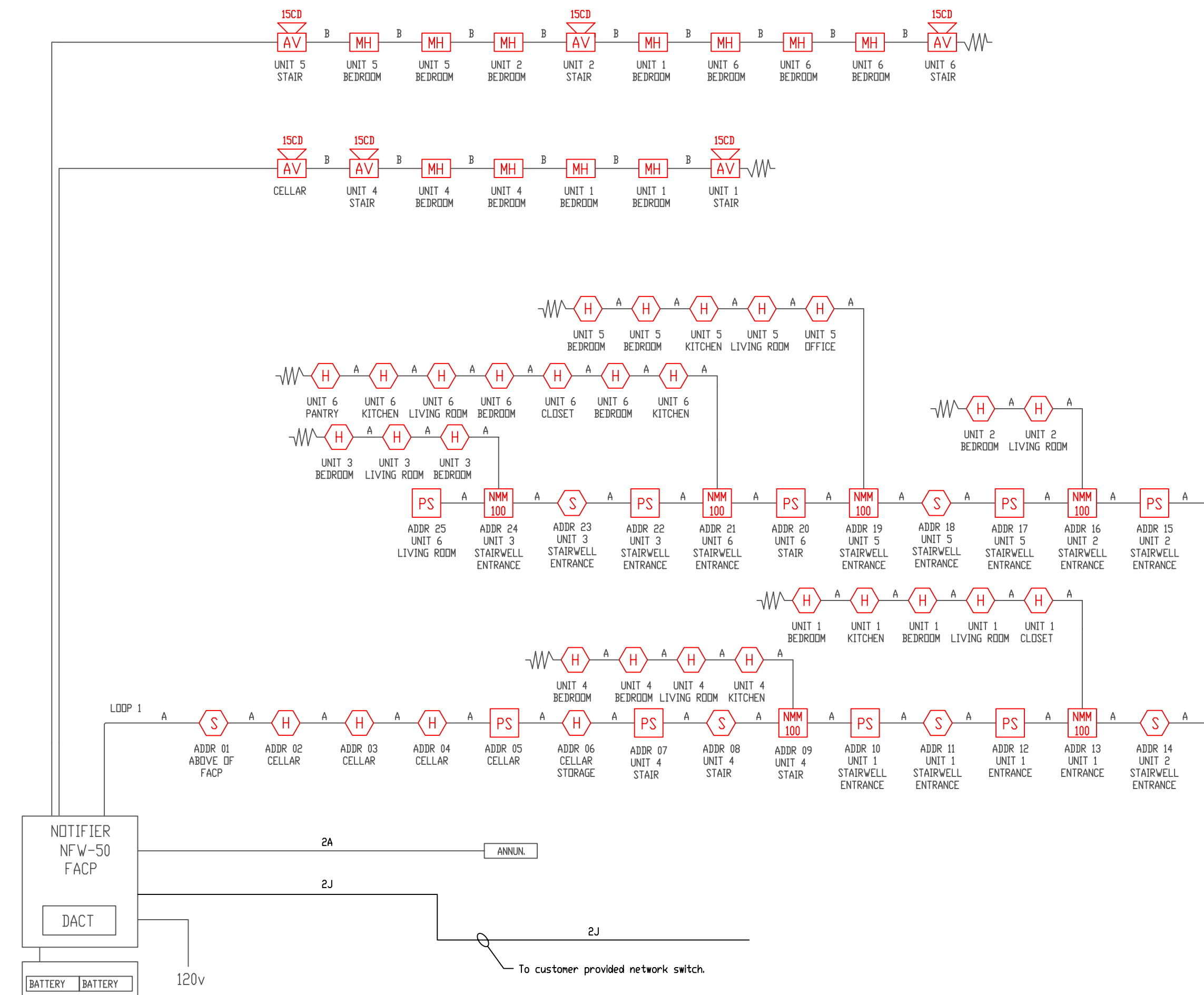
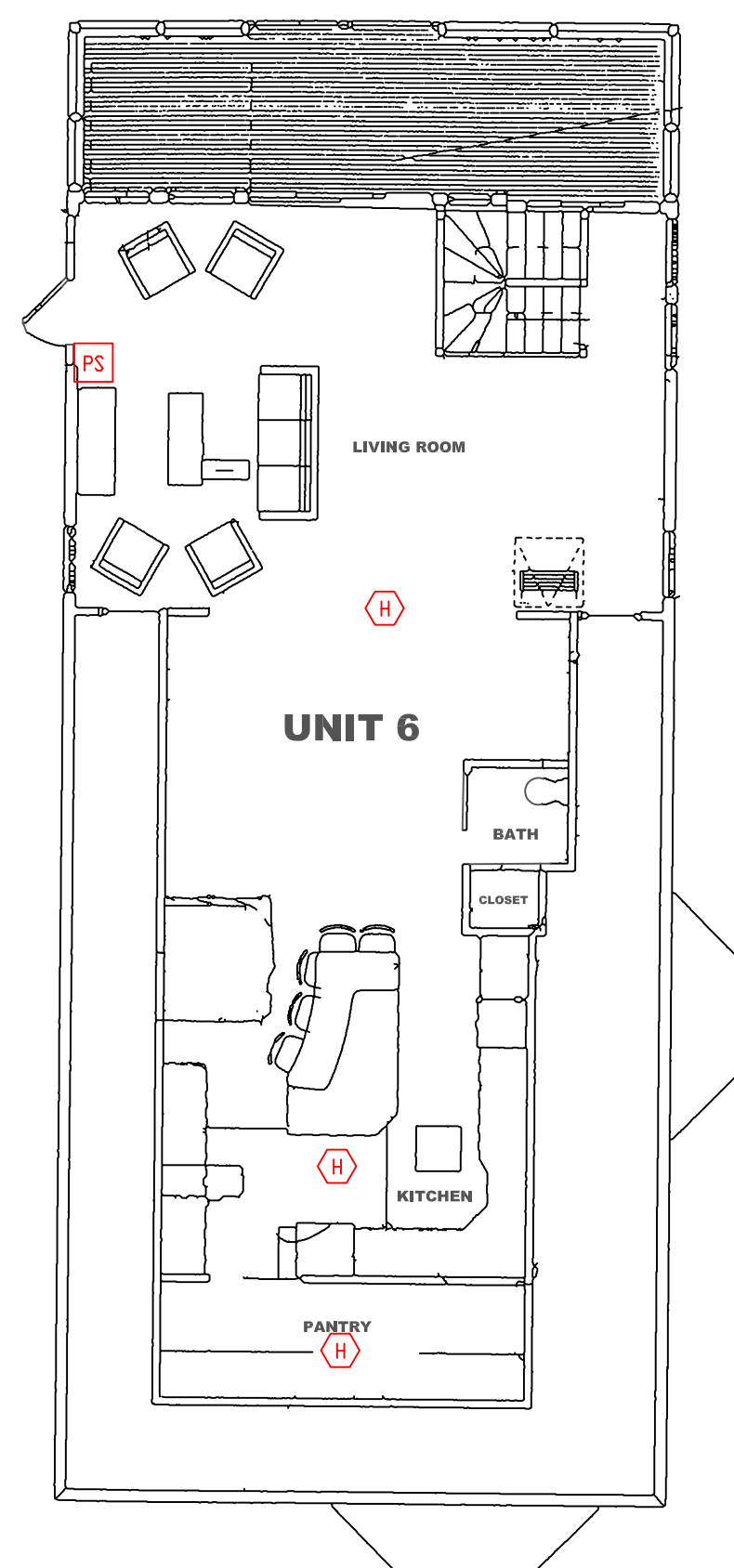

- 4.7k END OF LINE RESISTOR (Panel Circuits)
- A 1 PR #12 AWG TWISTED-PAIR CABLE FPL GENESIS WG-4315 & WG-4515 BELDEN 5020UL & 6020UL (Up to 10,000 ft)
 - A 1 PR #14 AWG TWISTED-PAIR CABLE FPL GENESIS WG-4313 & WG-4513 BELDEN 5120UL & 6120UL (Up to 8,000 ft)
 - A 1 PR #16 AWG TWISTED-PAIR CABLE FPL GENESIS WG-4311 & WG-4511 BELDEN 5220UL & 6220UL (Up to 4,500 ft)
 - B 1 PR #12 AWG FPL CABLE
 - D 1 PR #14 AWG FPL CABLE
 - E 1 PR #16 AWG FPL CABLE
 - F 2c #12 AWG CABLE
 - G 2c #14 AWG CABLE
 - H 2c #16 AWG CABLE
 - J 1 CAT5 CABLE

| | |
|------------|-------------------------|
| REVISION 2 | DATE: |
| REVISION 1 | DATE: |
| REVISION 0 | SUBMITTAL DATE: 5/24/11 |

SYSTEM WIRING RISER

| | |
|--|---------------------------------------|
| PROJECT NAME 125 Morning Street Portland, MAINE | SCALE NTS BY: CJC CK BY: |
| NORRIS INC. | |
| P.O. BOX 2551, SOUTH PORTLAND, MAINE 04116 2257 BROADWAY, SO. PORTLAND, MAINE | |
| SAVED AS: | |