

11 RATED WALL DETAIL  
SCALE: 1" = 1'-0"

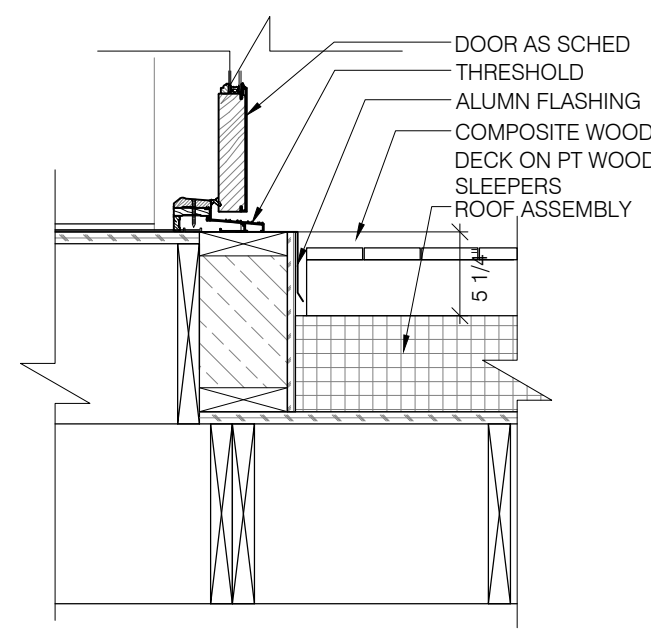

12 ROOF THRESHOLD DETAIL  
SCALE: 1" = 1'-0"

13 DETAIL  
SCALE: 1" = 1'-0"

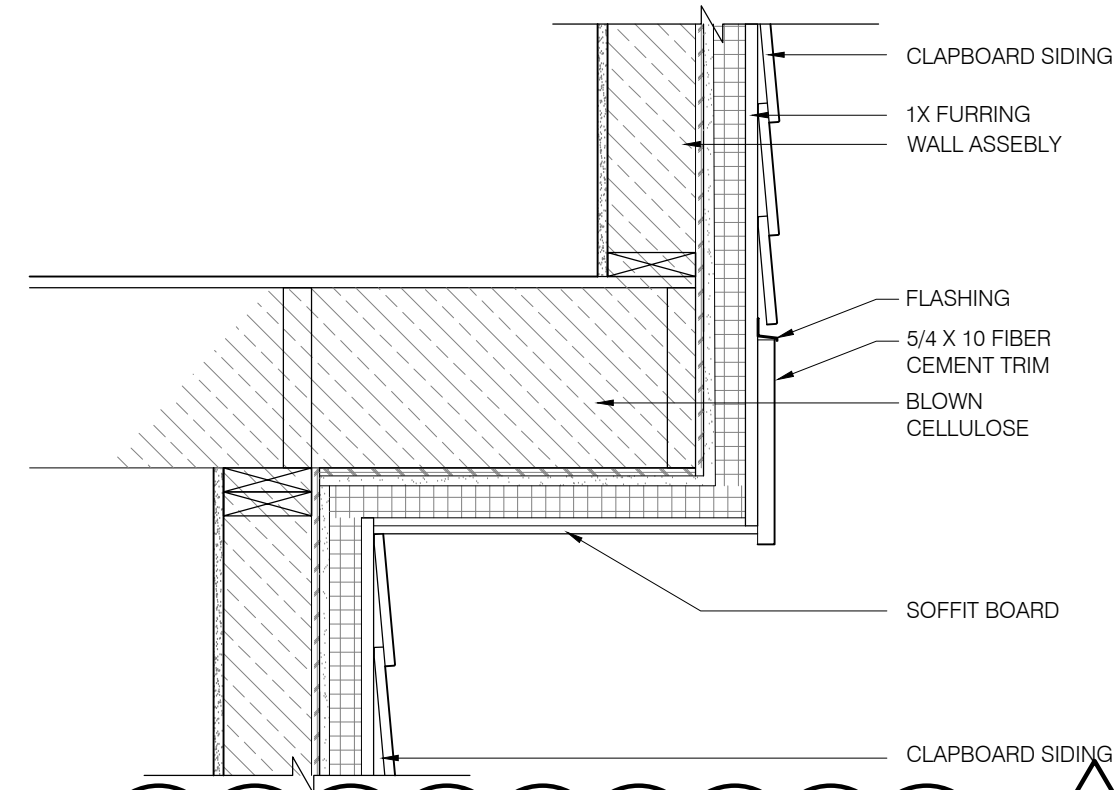

8 OVERHANG DETAIL  
SCALE: 1" = 1'-0"

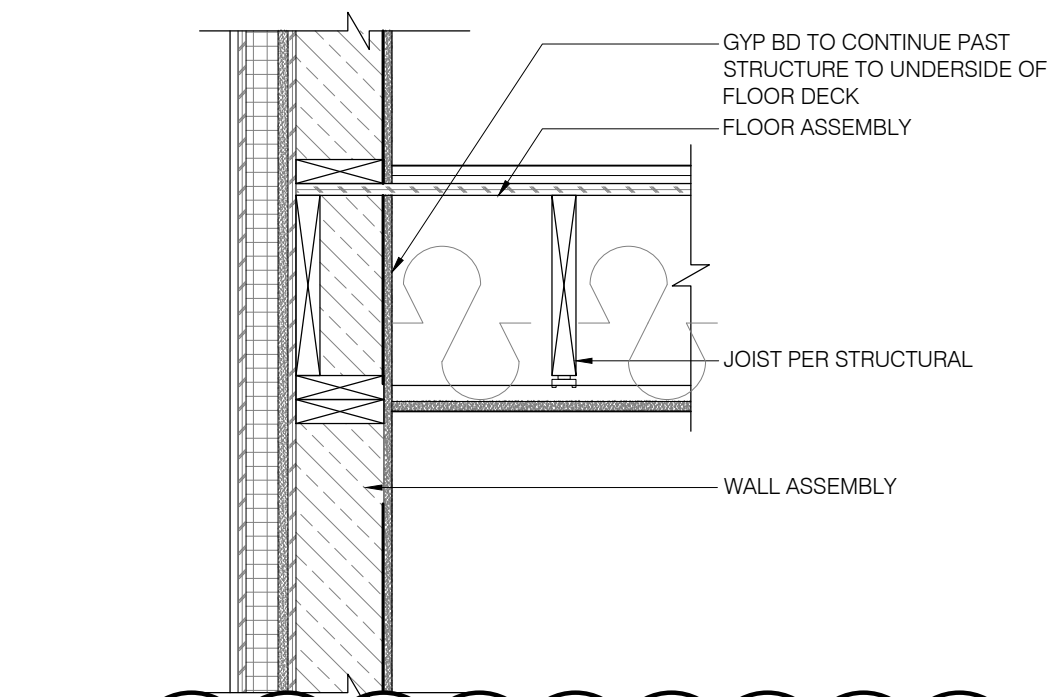

9 EXTERIOR WALL DETAIL  
SCALE: 1" = 1'-0"

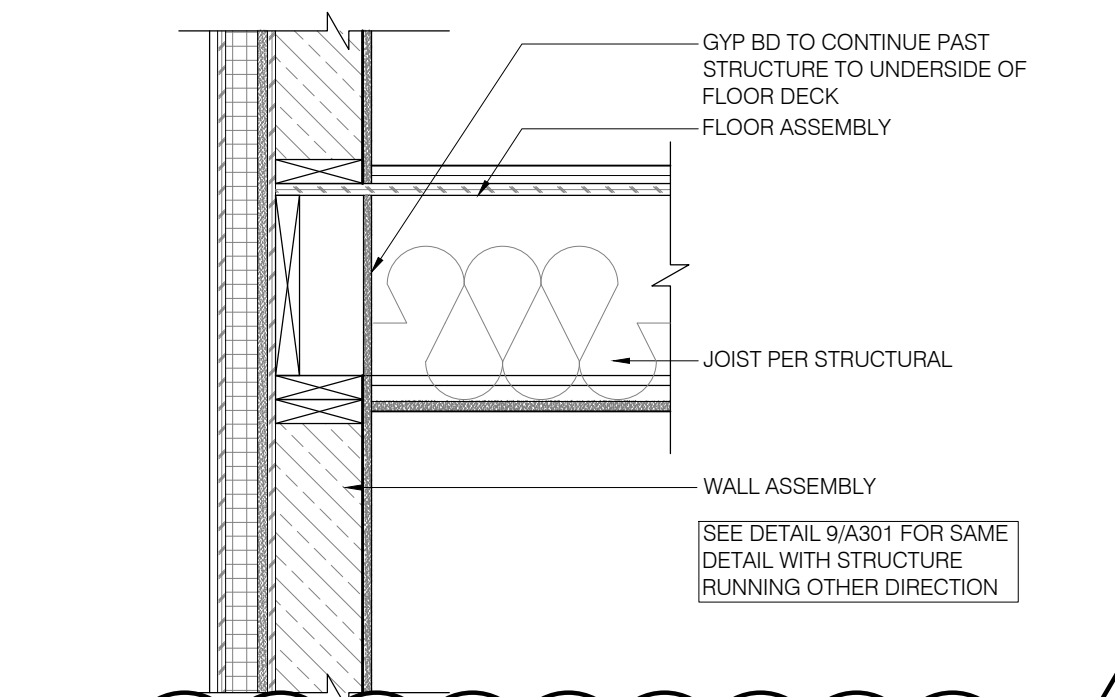

10 EXTERIOR WALL DETAIL  
SCALE: 1" = 1'-0"

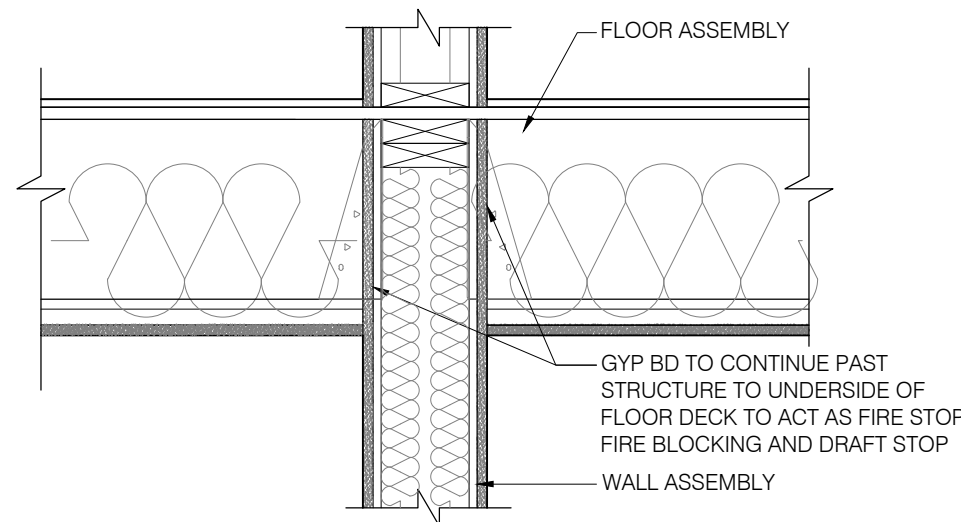

5 RATED WALL DETAIL  
SCALE: 1" = 1'-0"

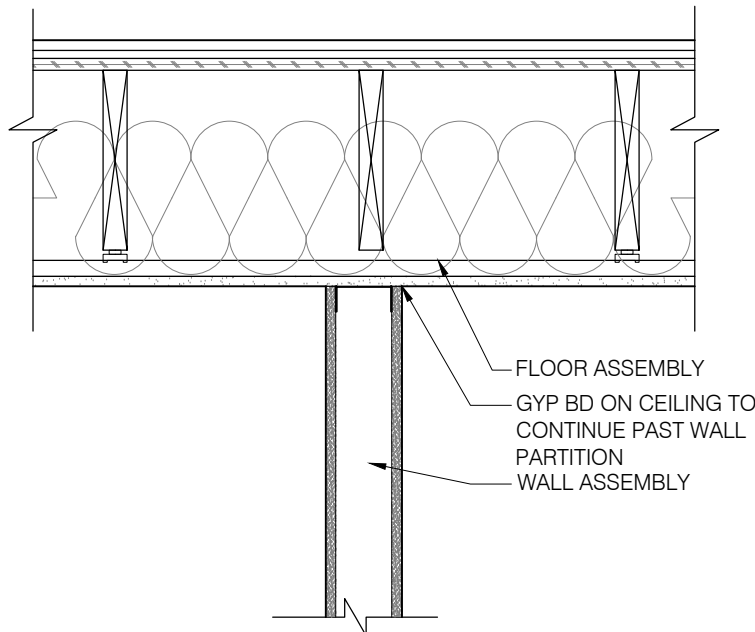

6 PARTITION DETAIL  
SCALE: 1" = 1'-0"

7 DETAIL  
SCALE: 1" = 1'-0"

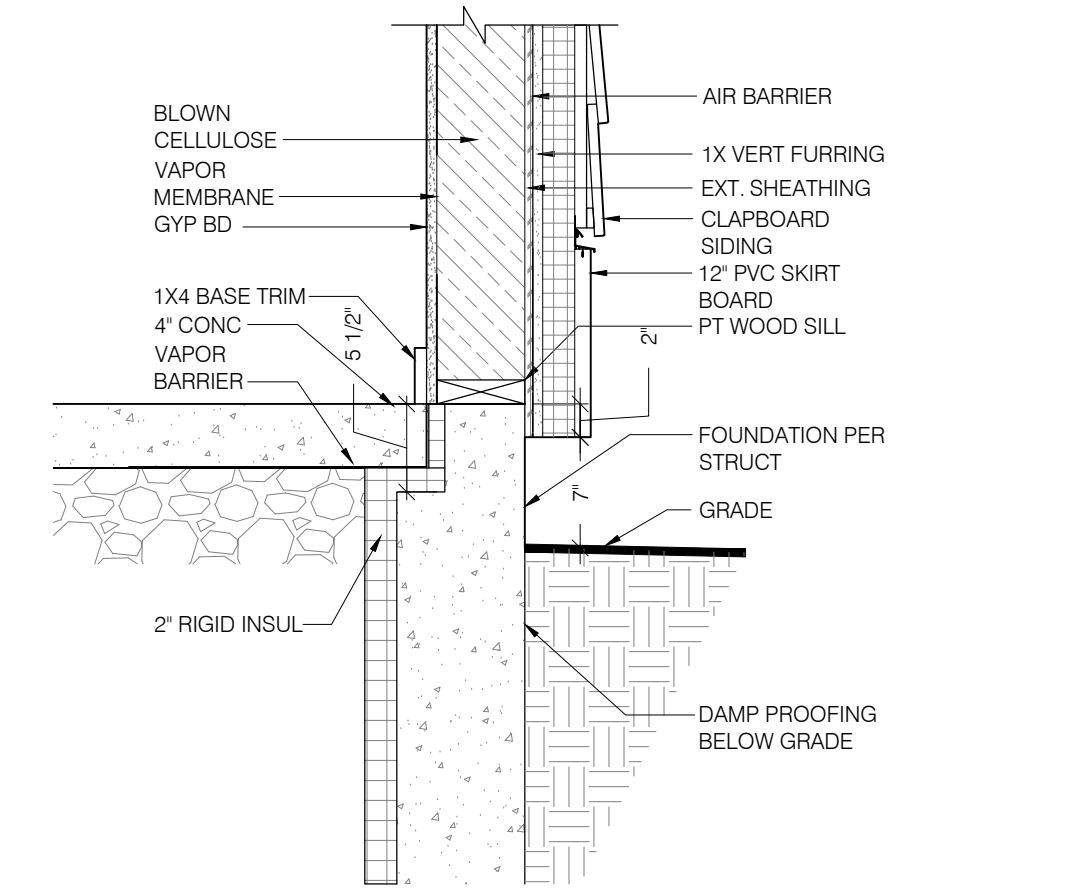

2 FOUNDATION DETAIL  
SCALE: 1" = 1'-0"

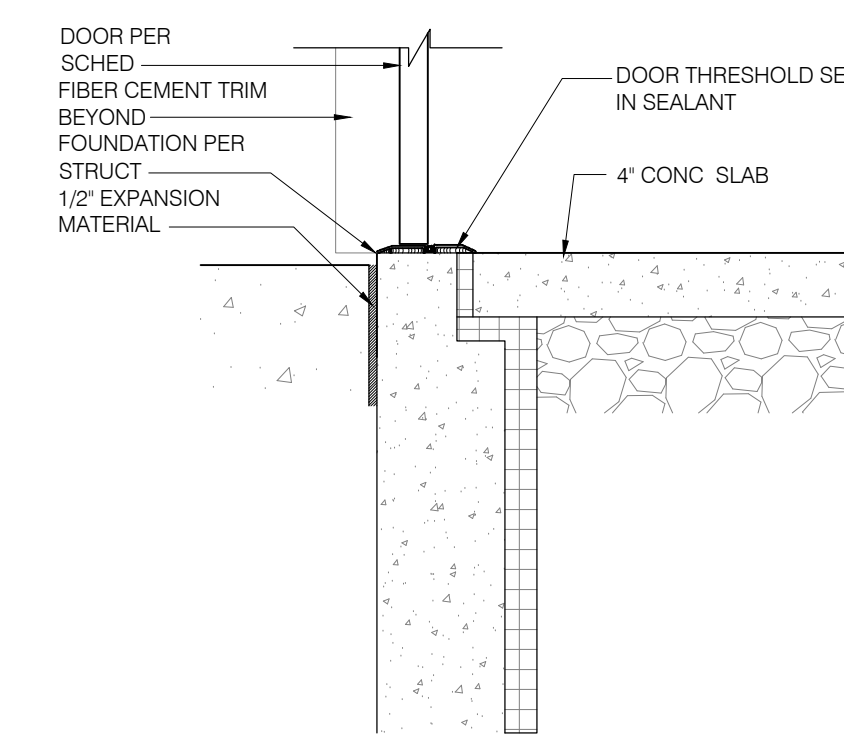

3 THRESHOLD DETAIL  
SCALE: 1" = 1'-0"

4 DETAIL  
SCALE: 1" = 1'-0"

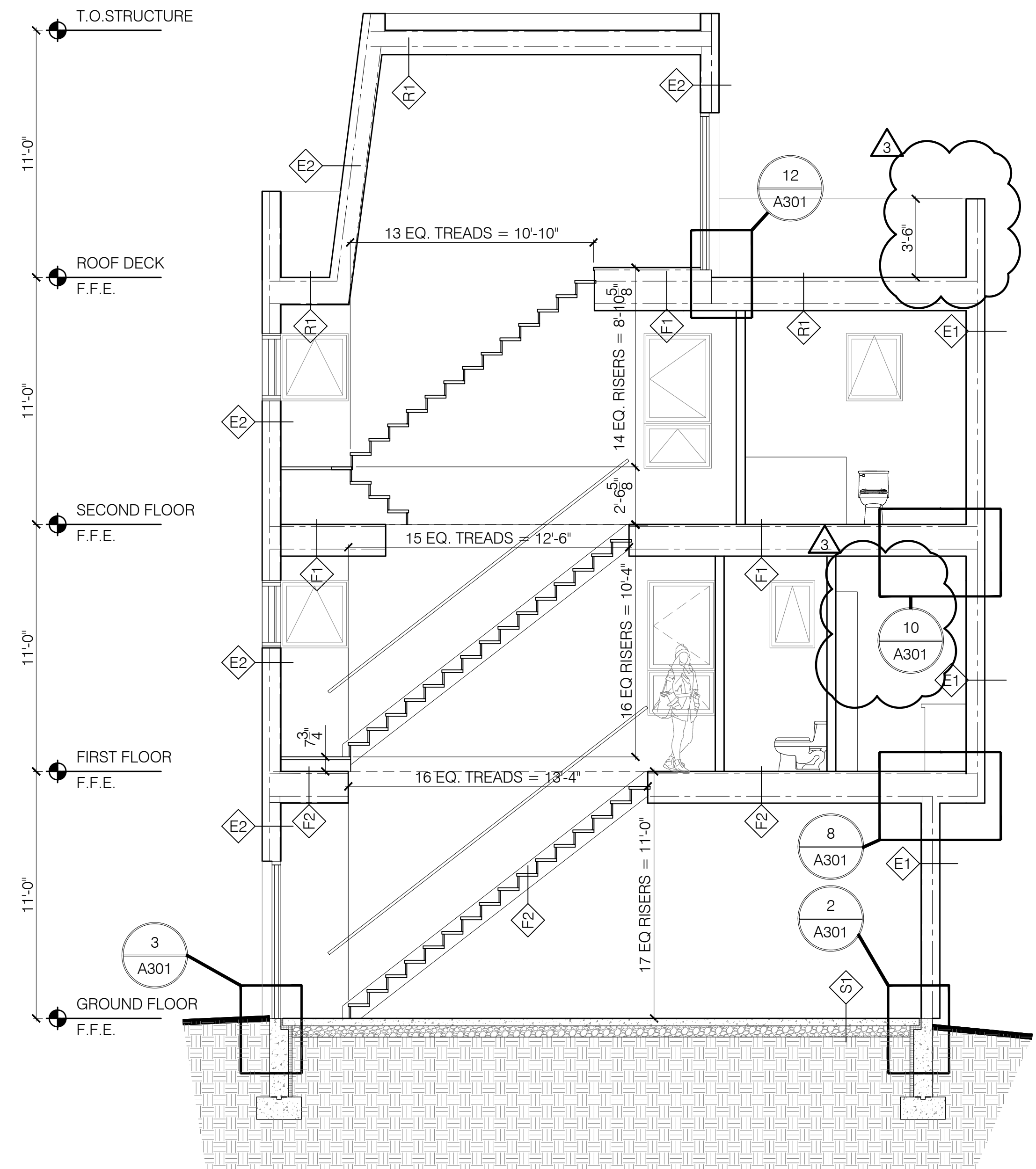

1 BUILDING SECTION  
SCALE: 1/4" = 1'-0"