

TYP FOUNDATION DETAIL  
N.T.S.

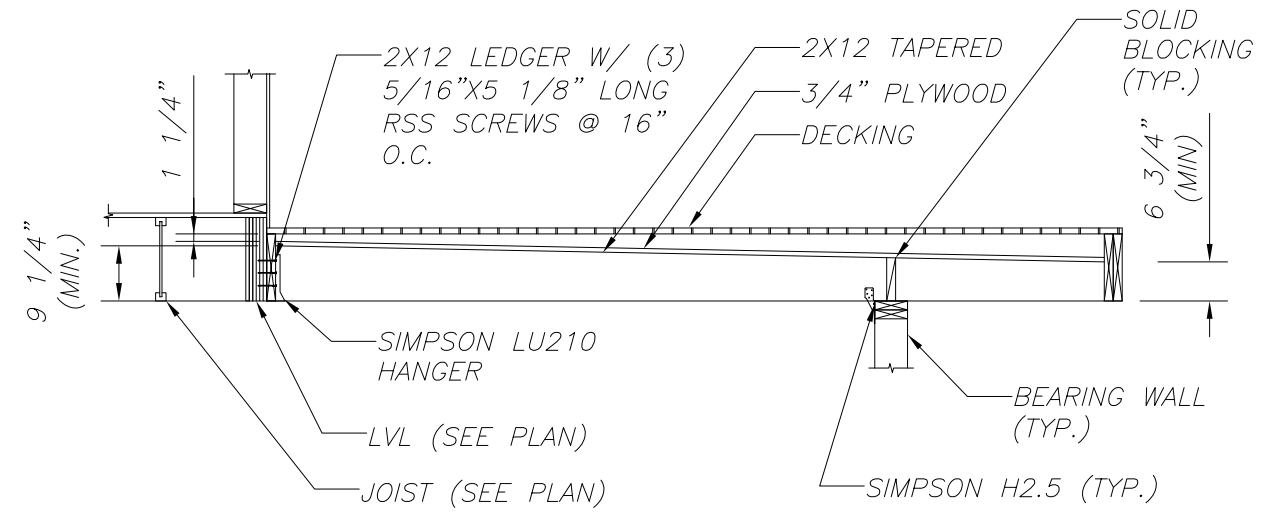

DECK DETAIL  
N.T.S.

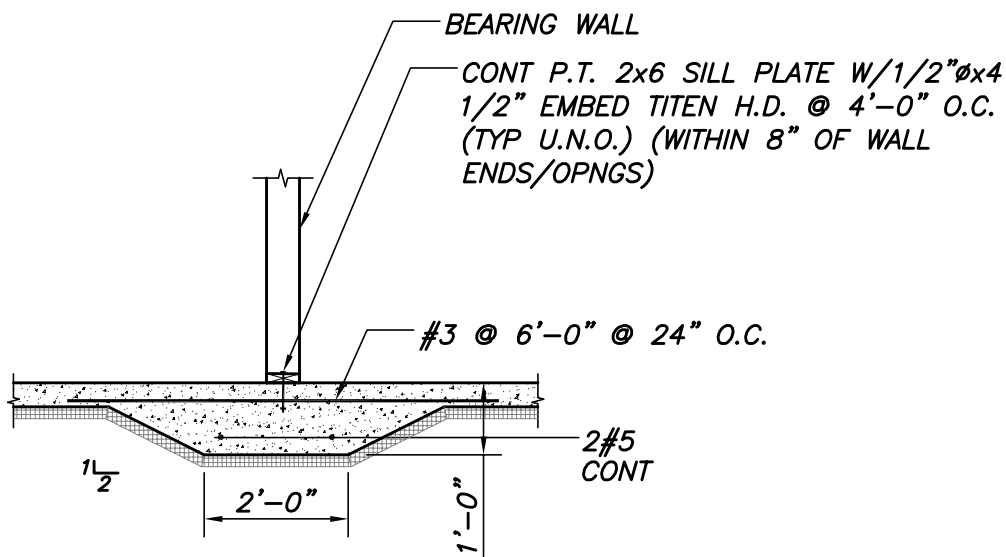

TYP THICKENED SLAB DETAIL  
N.T.S.

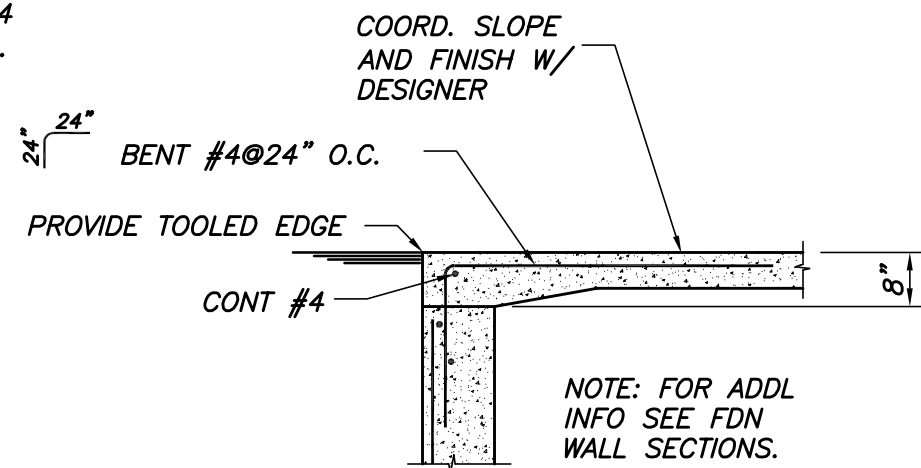

TOP OF WALL DETAIL @ GARAGE DOOR  
N.T.S.

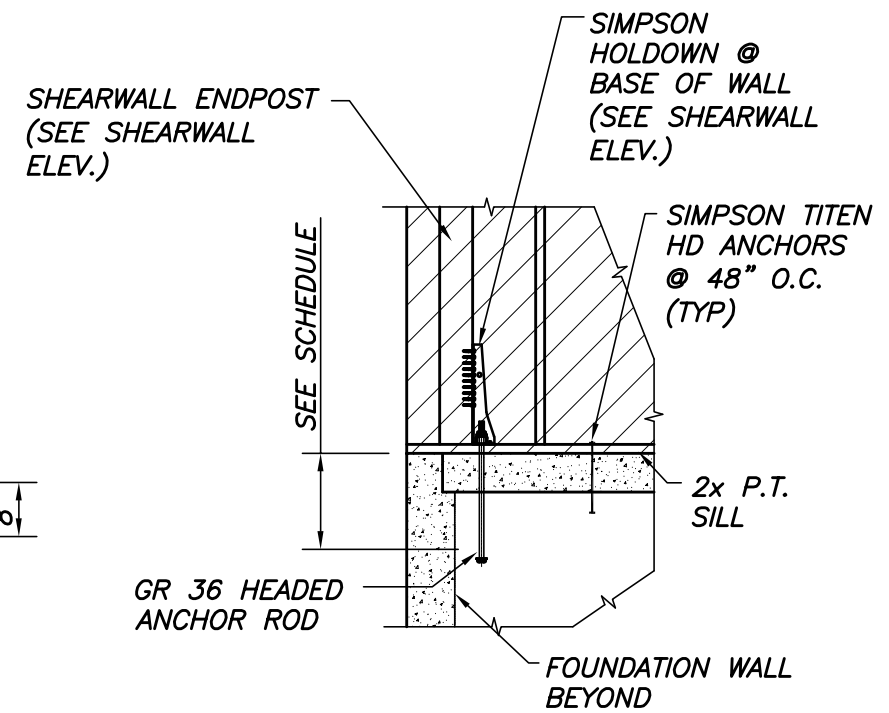

TYP HOLDOWN DETAIL  
N.T.S.

HOWARD ST.  
RESIDENCE  
PORTLAND, ME

SECTIONS  
& DETAILS

DATE: 07/11/2017

SHEET: S2.1