

COPYRIGHT: Reuse or reproduction of the contents of this document is not permitted without written permission of Bild Architecture LLC

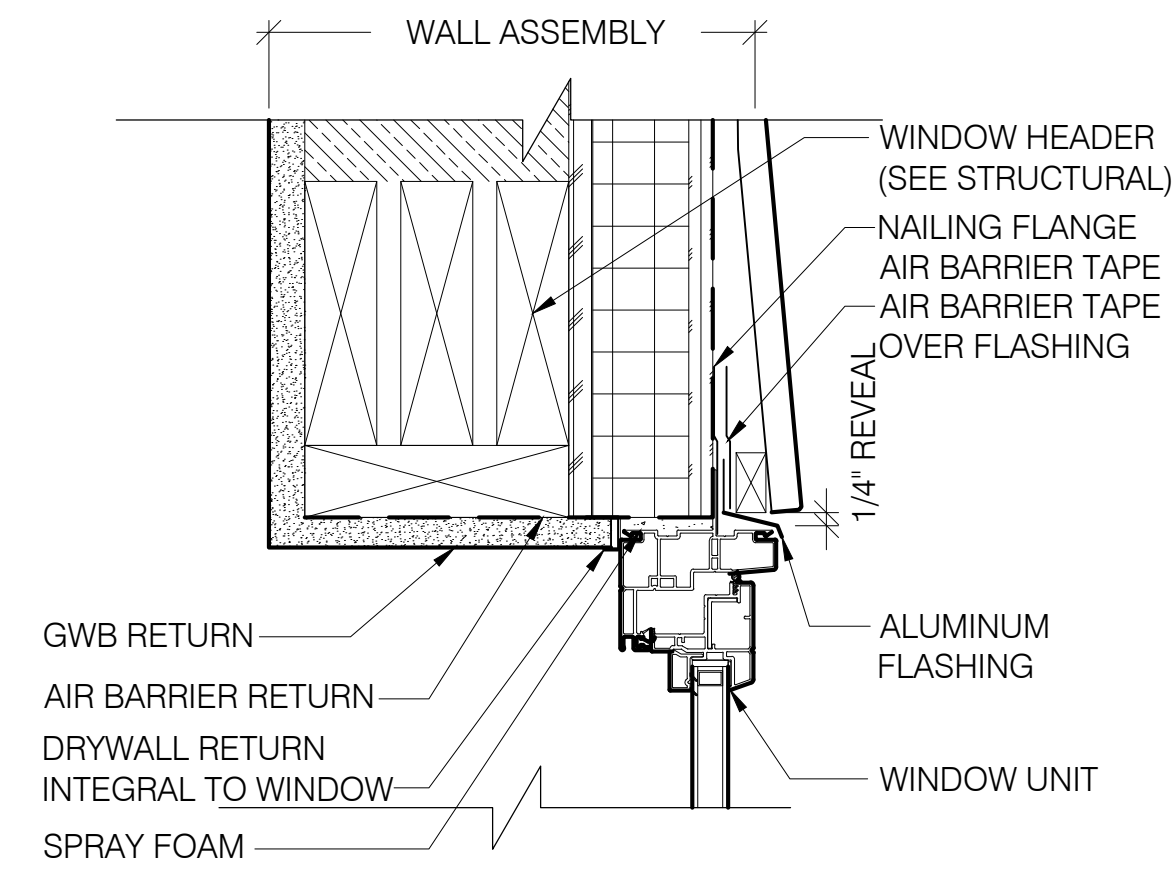

1 HEAD - TYPICAL WINDOW
SCALE: 3" = 1'-0"

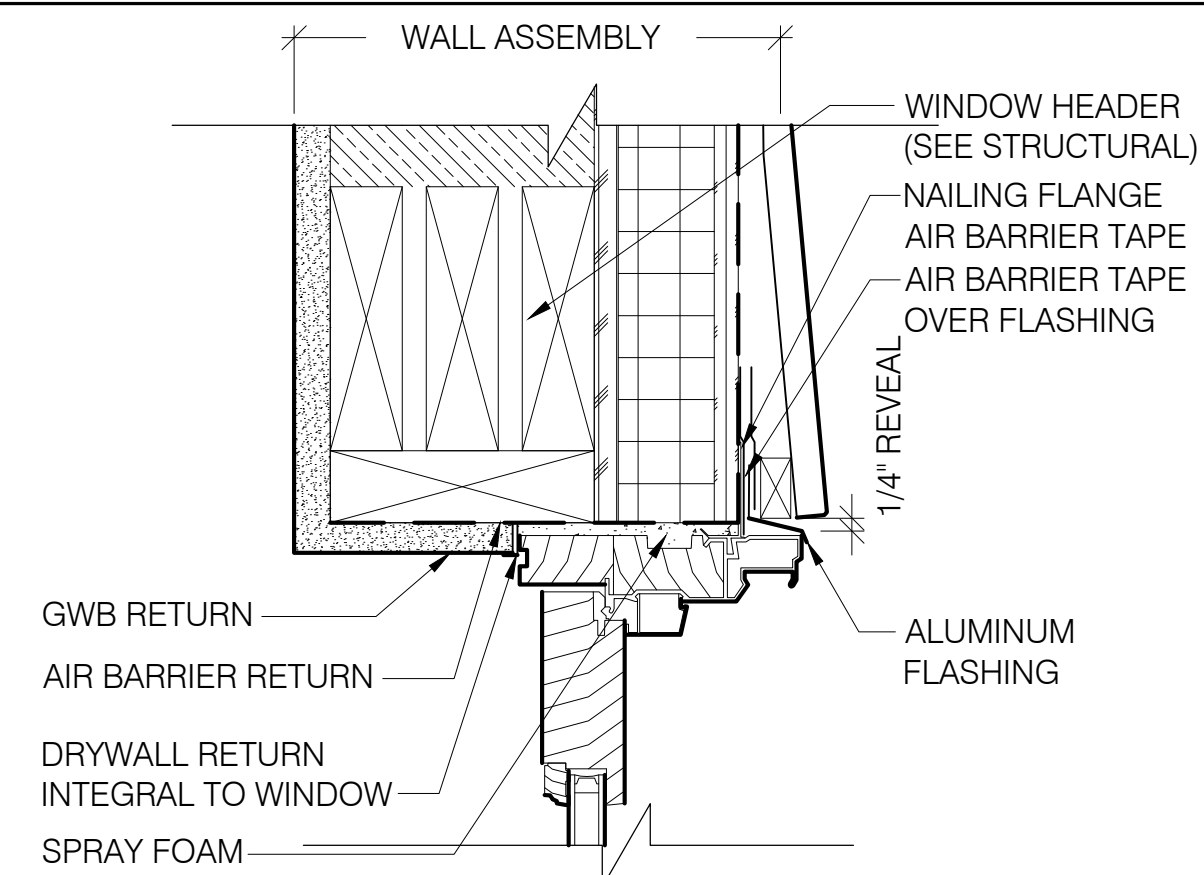

5 HEAD - BALCONY DOOR
SCALE: 3" = 1'-0"

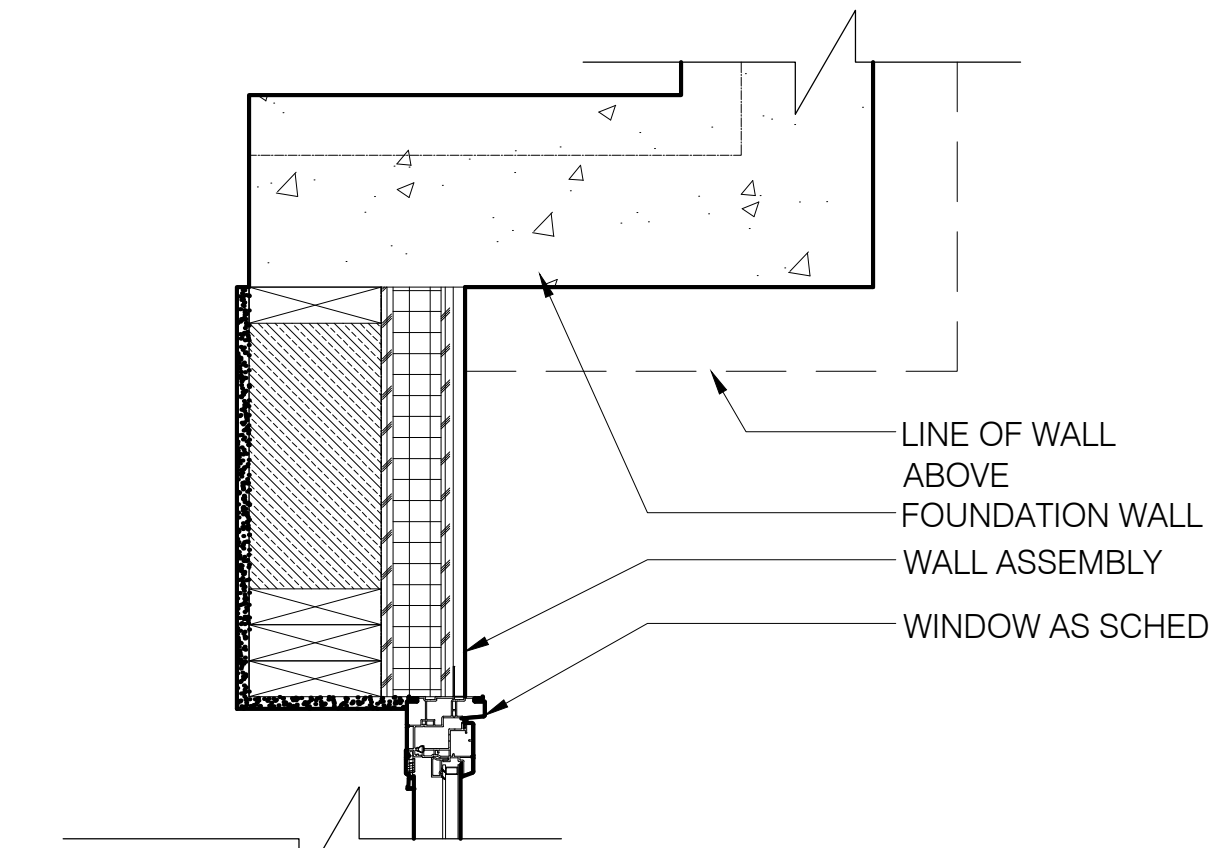

9 JAMB - FRONT SIDE LIGHTS
SCALE: 1-1/2" = 1'-0"

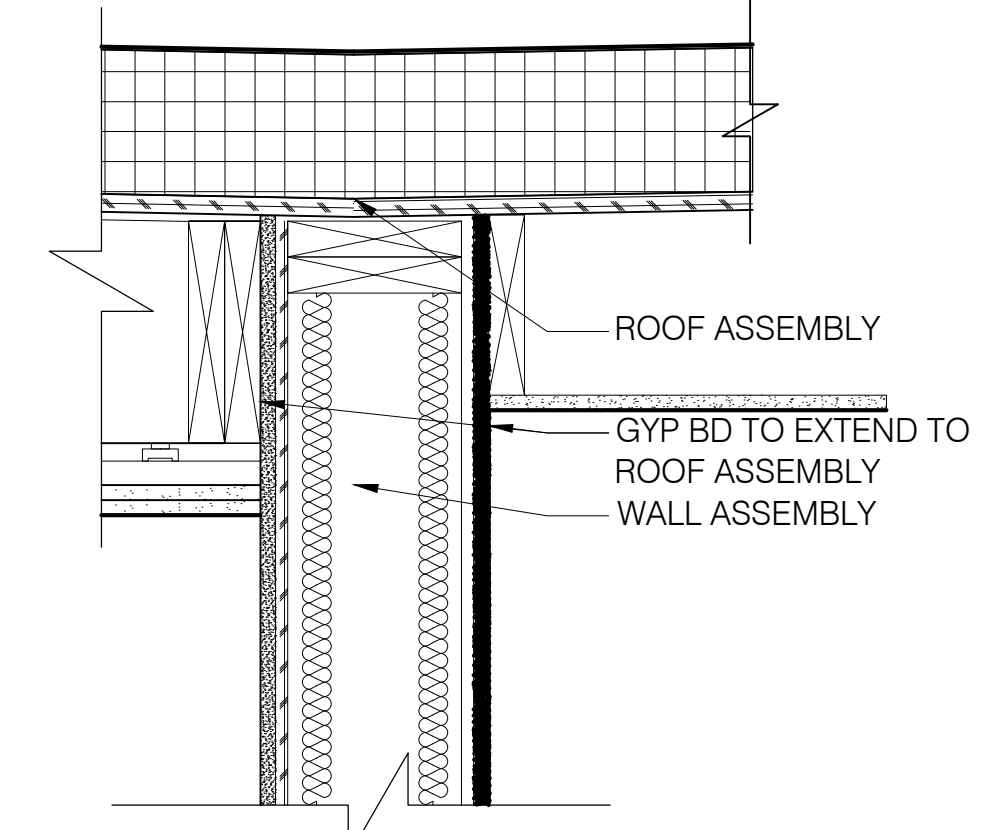

11 T.O. WALL @ STAIR SHAFT
SCALE: 1-1/2" = 1'-0"

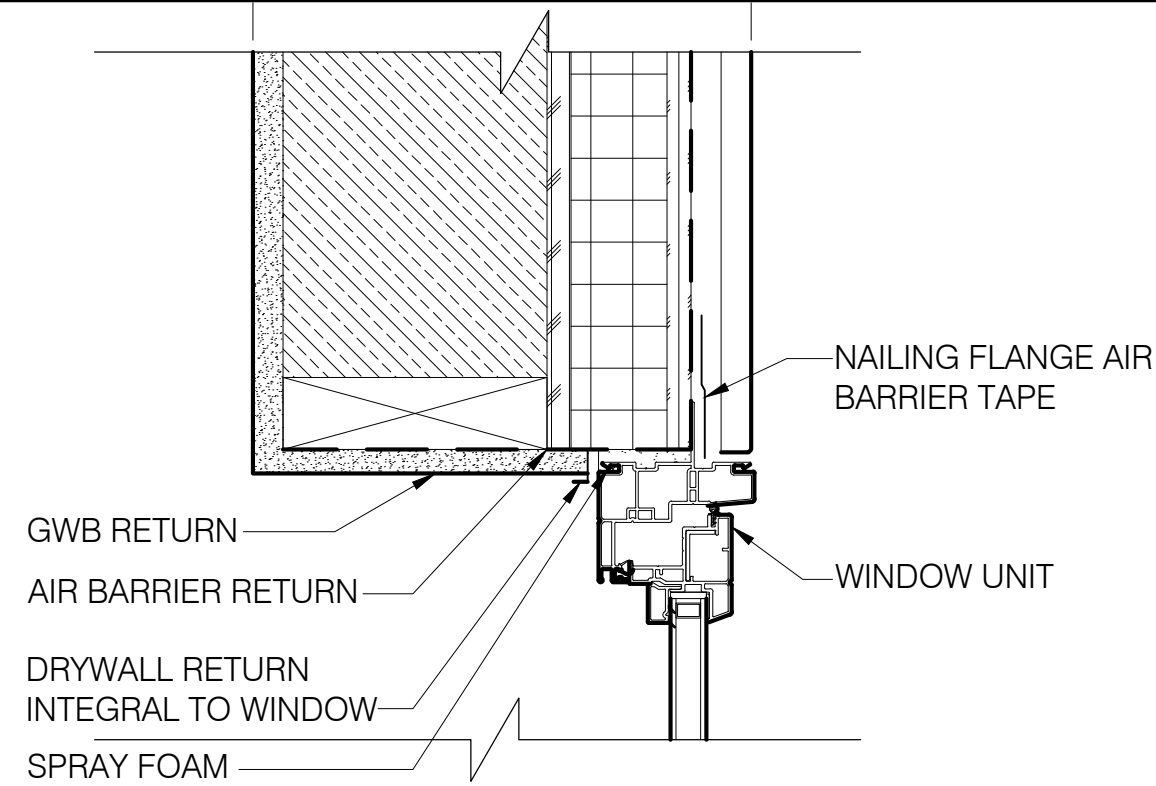

2 JAMB - TYPICAL WINDOW
SCALE: 3" = 1'-0"

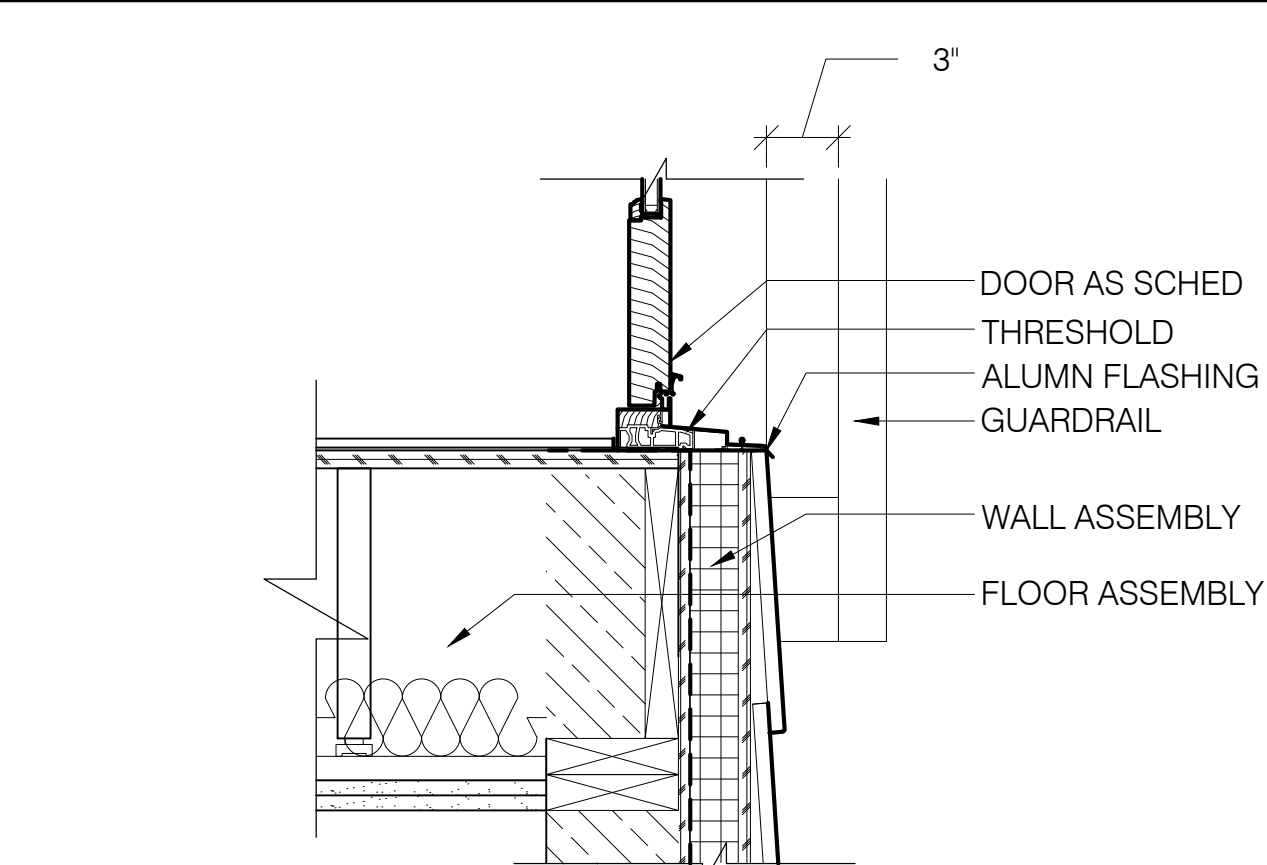

6 SILL - BALCONY DOOR
SCALE: 1-1/2" = 1'-0"

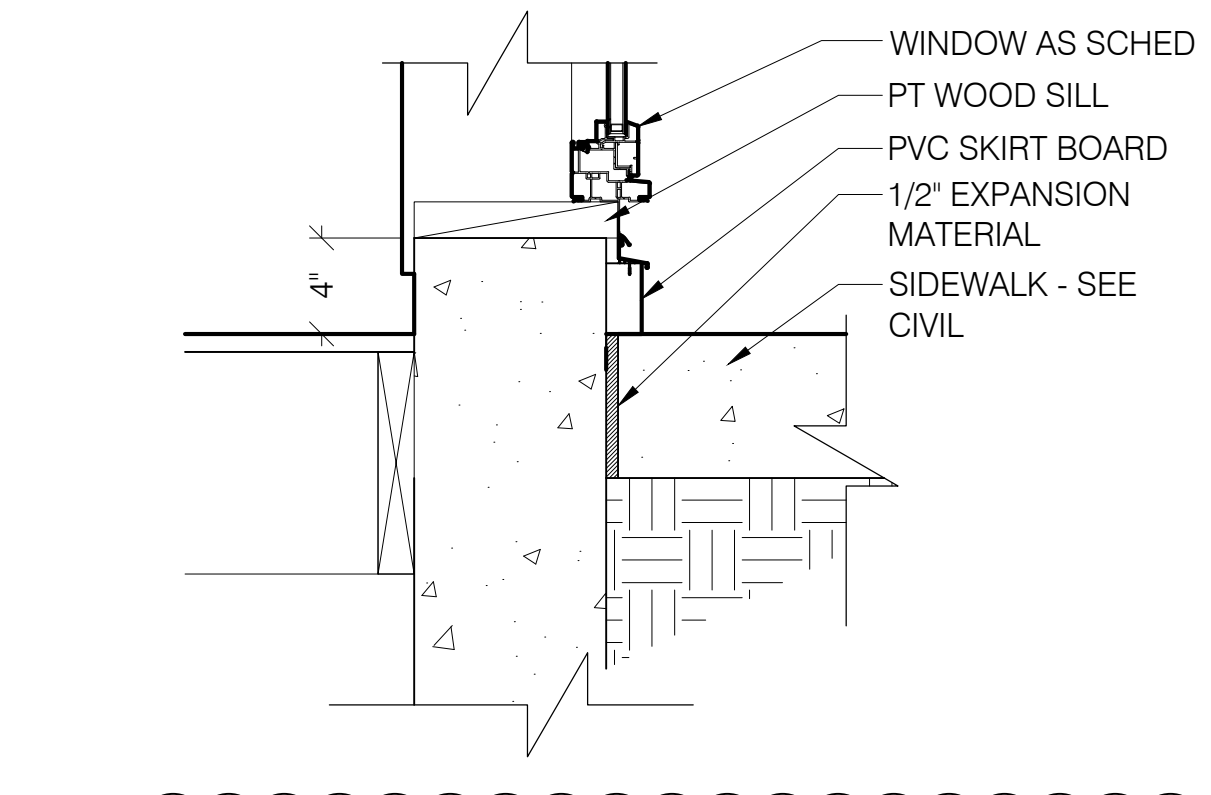

10 SILL - FRONT SIDE LIGHTS
SCALE: 1-1/2" = 1'-0"

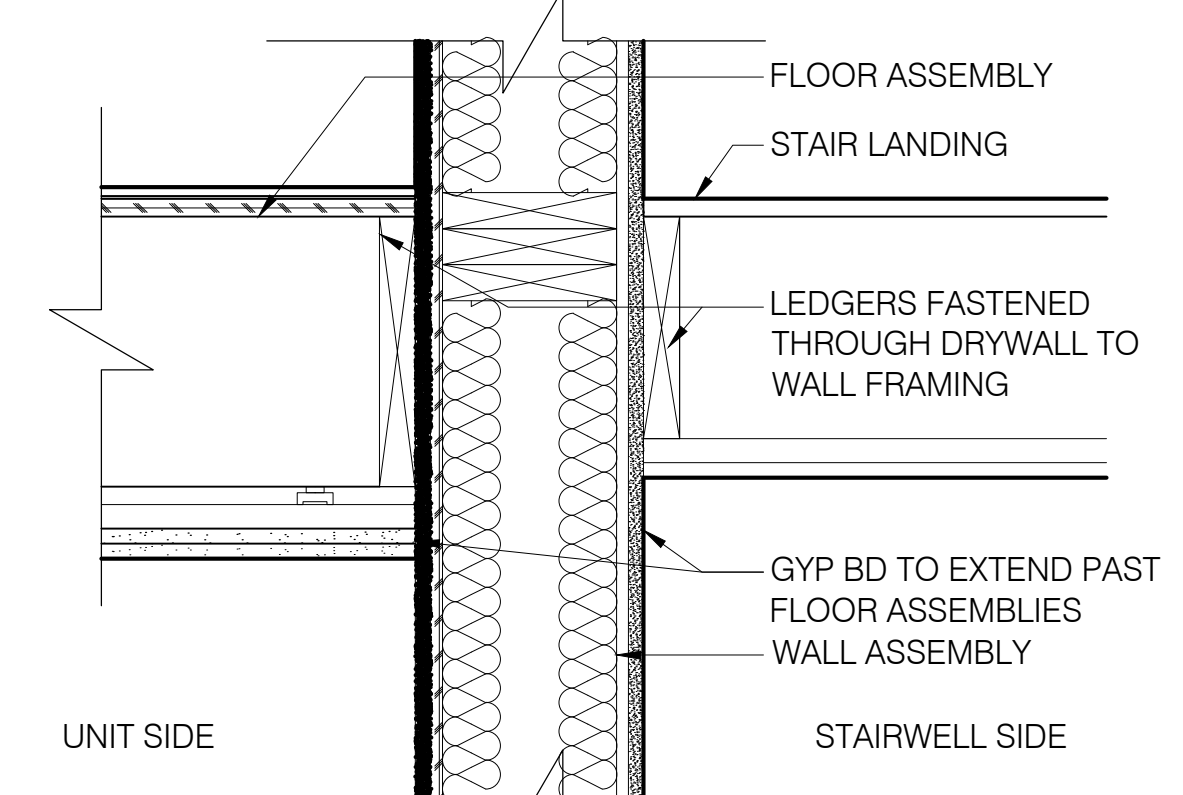

12 RATED WALL STAIR/UNIT
SCALE: 1-1/2" = 1'-0"

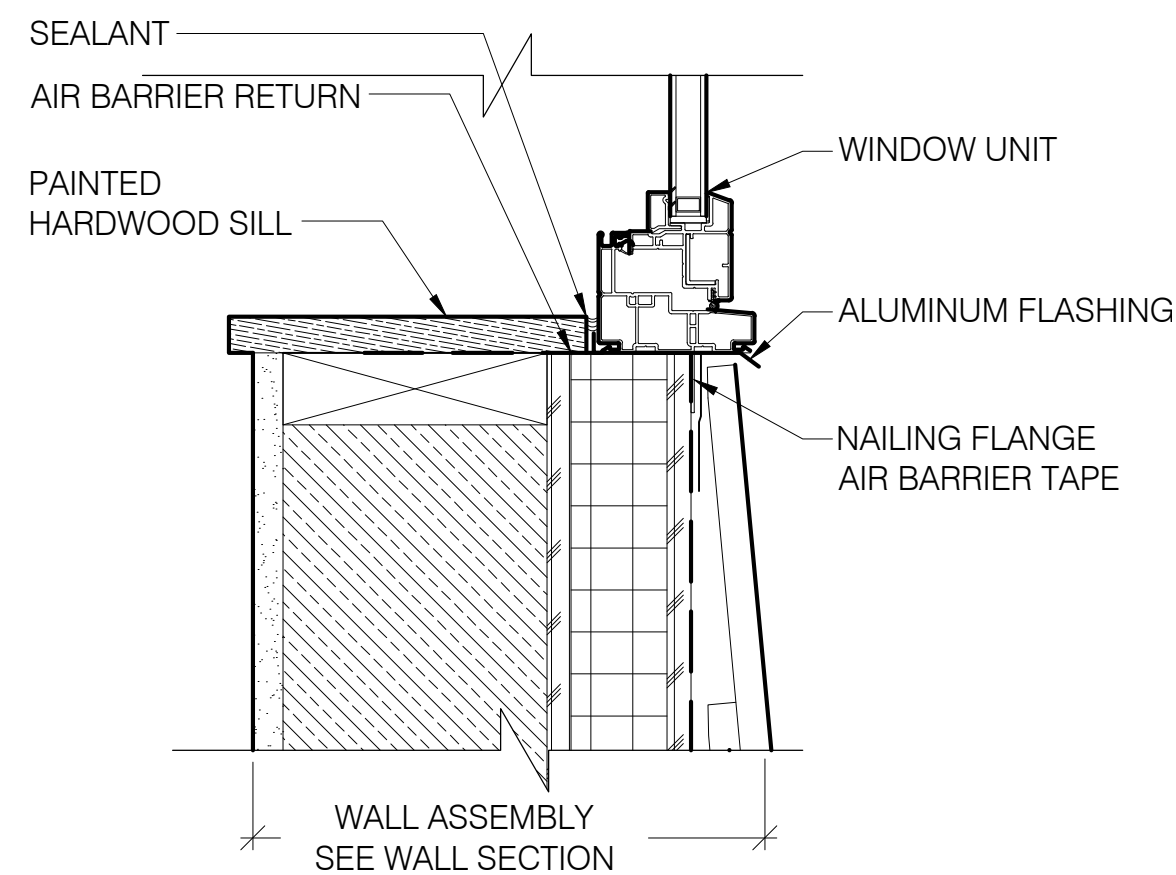

3 SILL - TYPICAL WINDOW
SCALE: 3" = 1'-0"

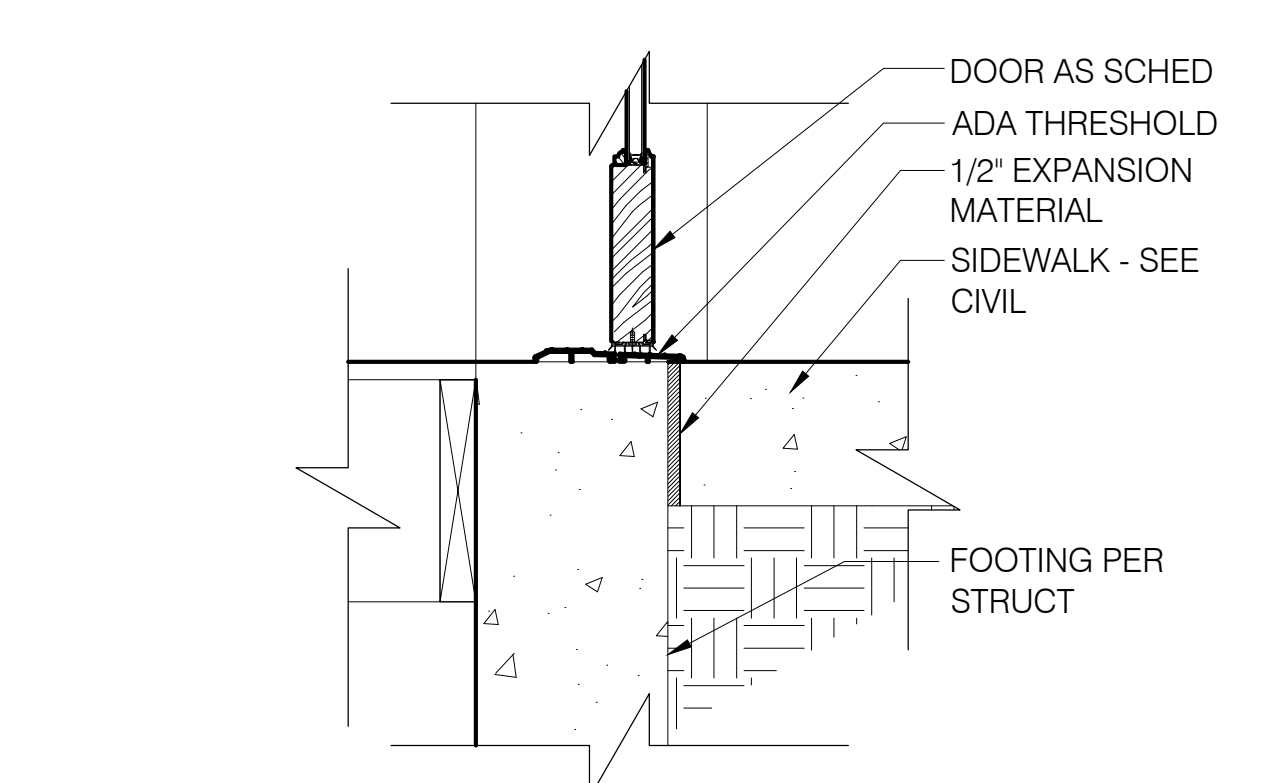

7 SILL - FRONT ENTRY DOOR
SCALE: 1-1/2" = 1'-0"

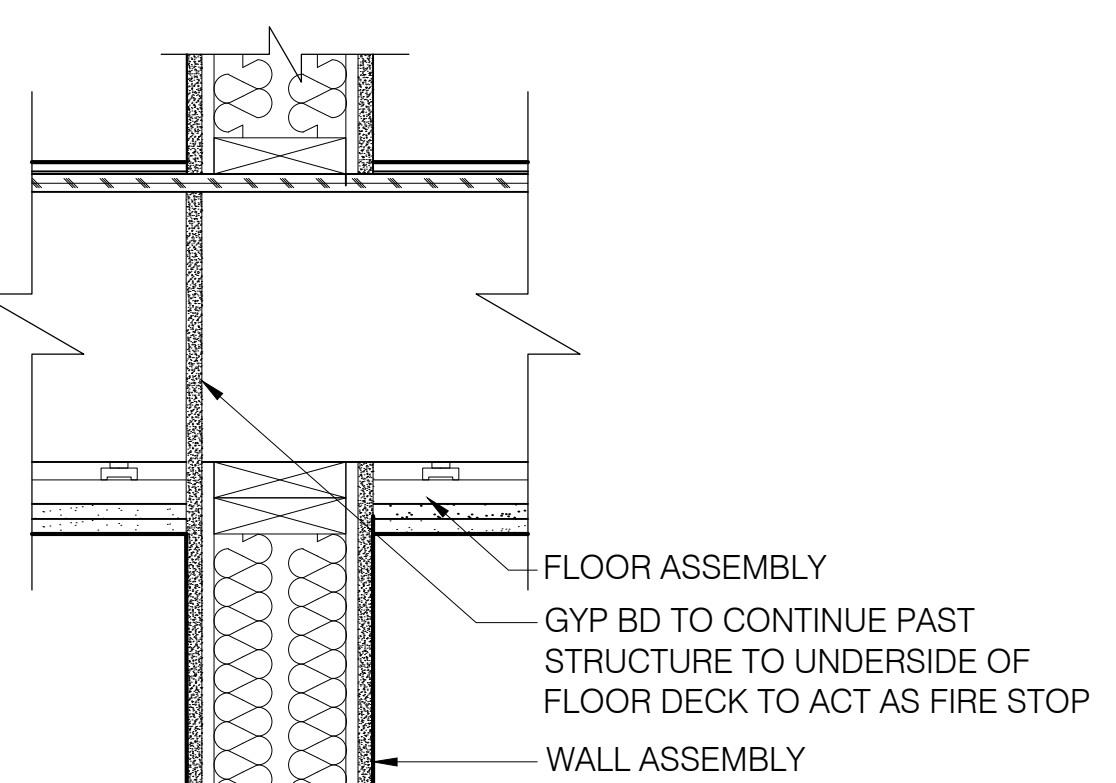

13 RATED WALL BETWEEN UNITS
SCALE: 1-1/2" = 1'-0"

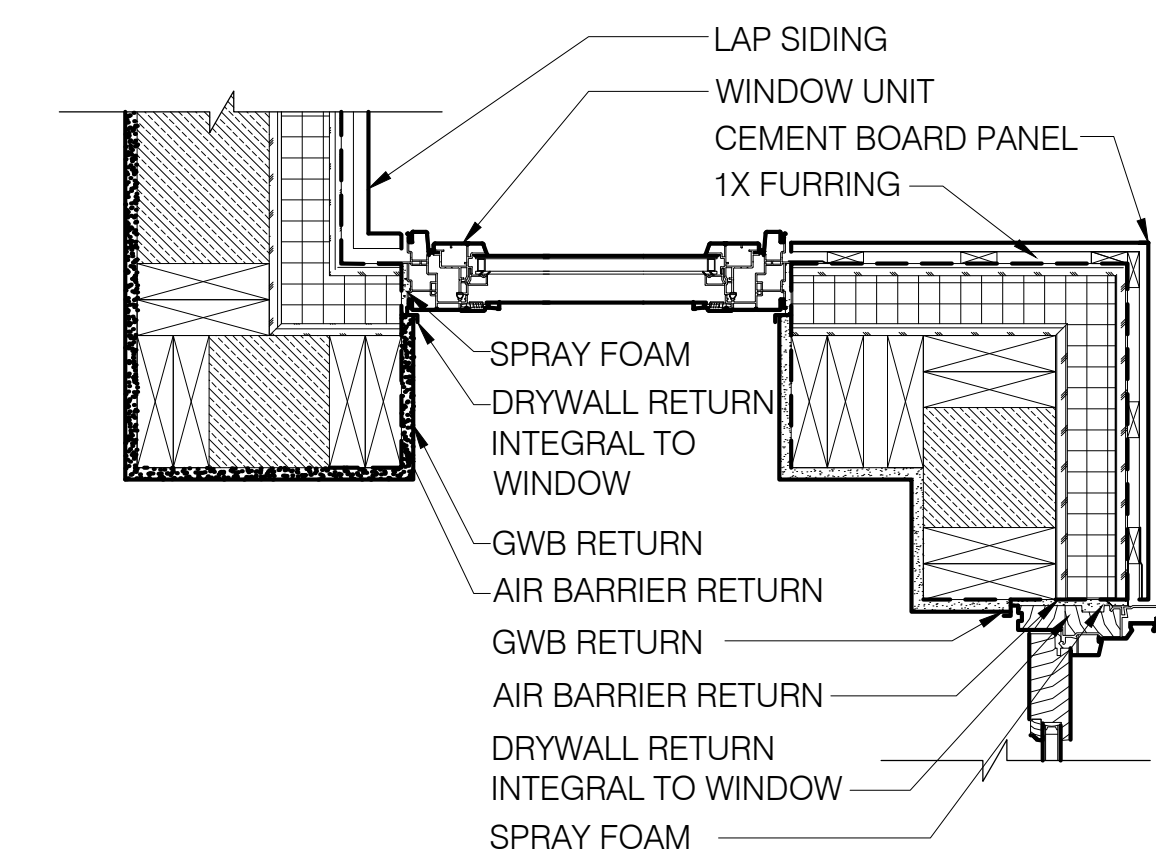

4 JAMB - BAY WINDOW
SCALE: 1-1/2" = 1'-0"

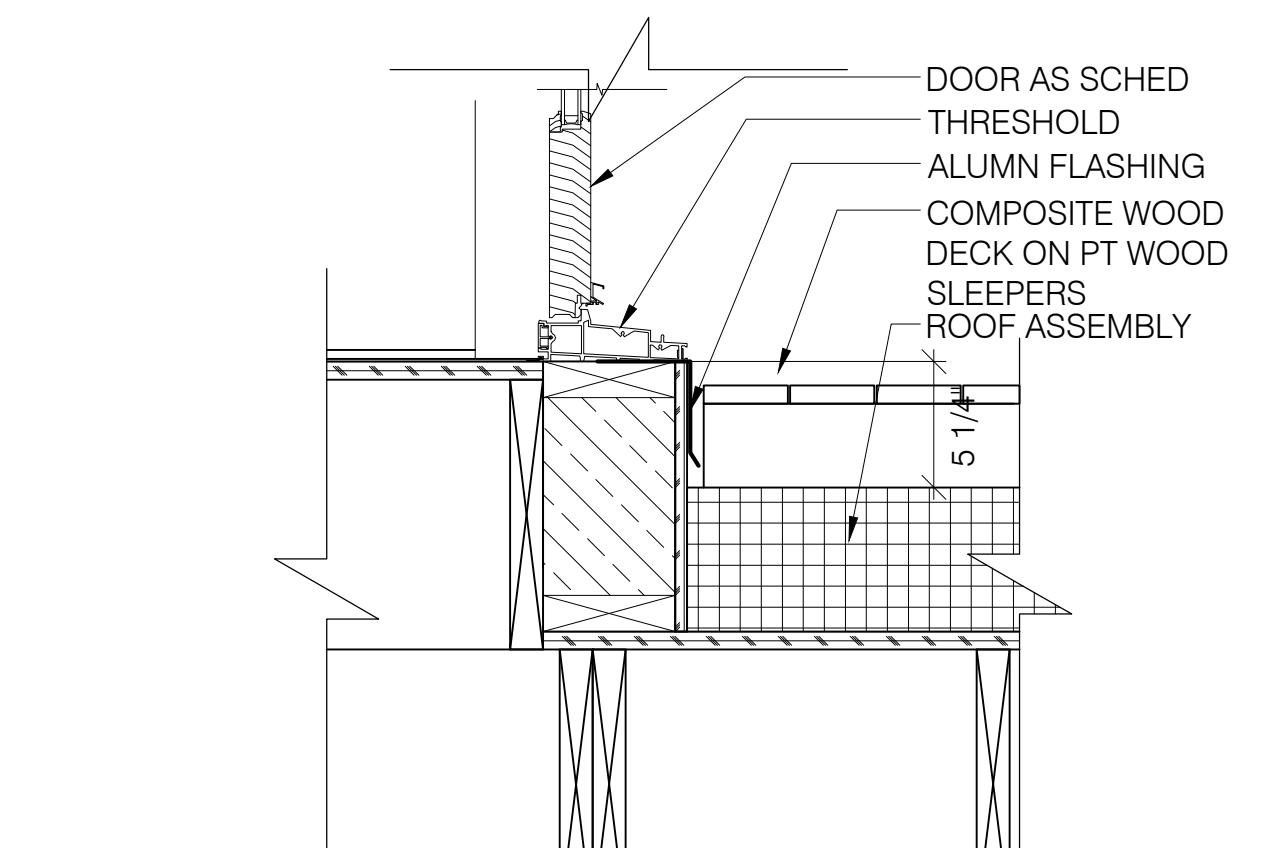

8 SILL - ROOFTOP DOOR
SCALE: 1-1/2" = 1'-0"

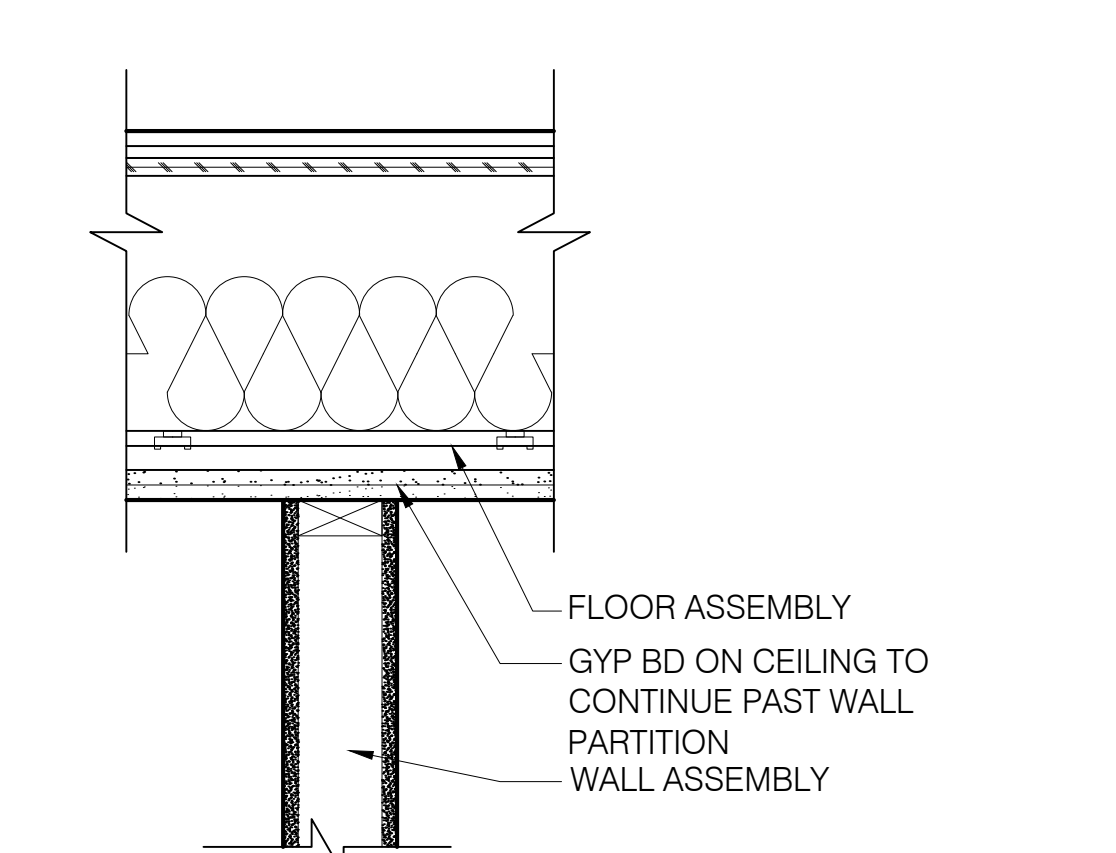

14 T.O. PARTITION
SCALE: 1-1/2" = 1'-0"