

COPYRIGHT: Reuse or reproduction of the contents of this document is not permitted without written permission of Bild Architecture LLC

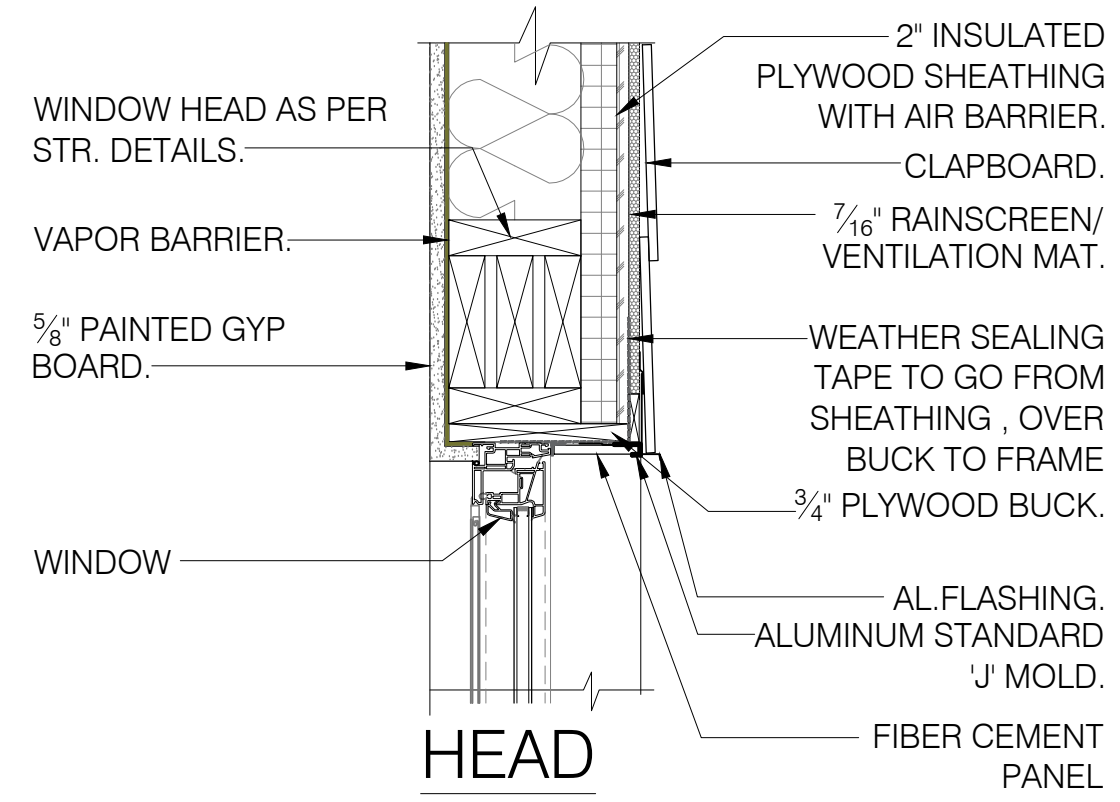

HEAD

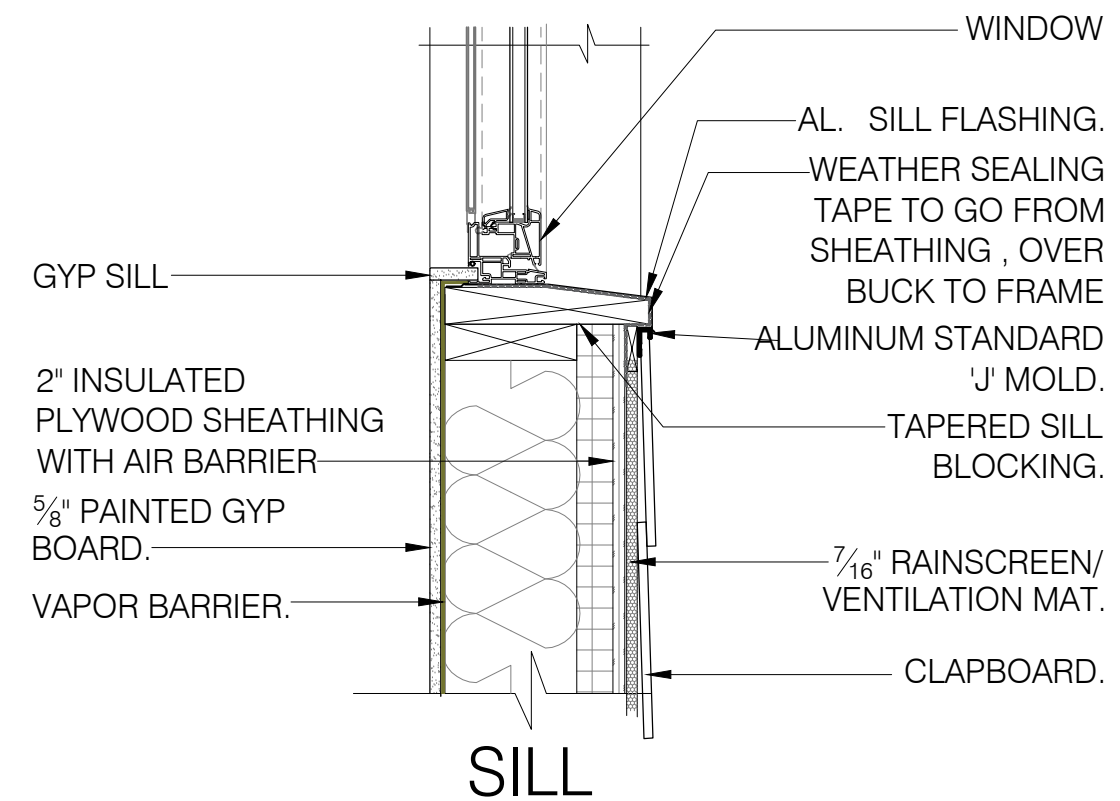

SILL

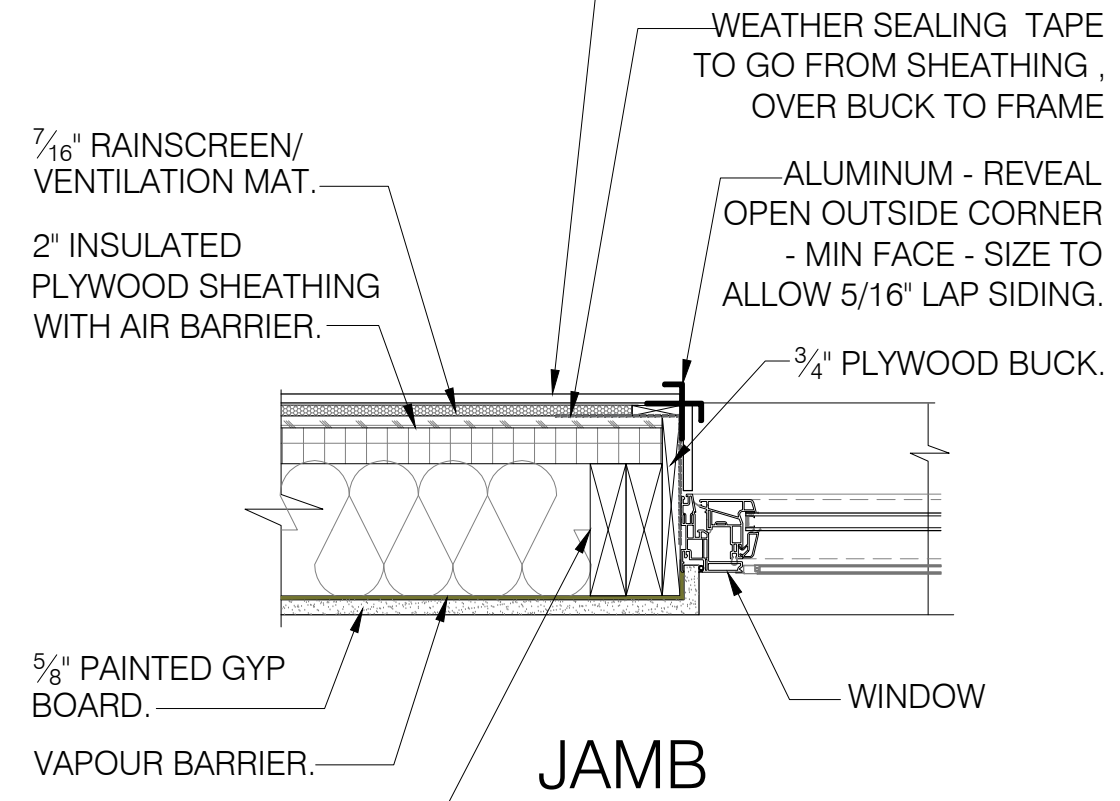

JAMB

1 WINDOW DTLS - TYP.
SCALE: 1-1/2" = 1'-0"

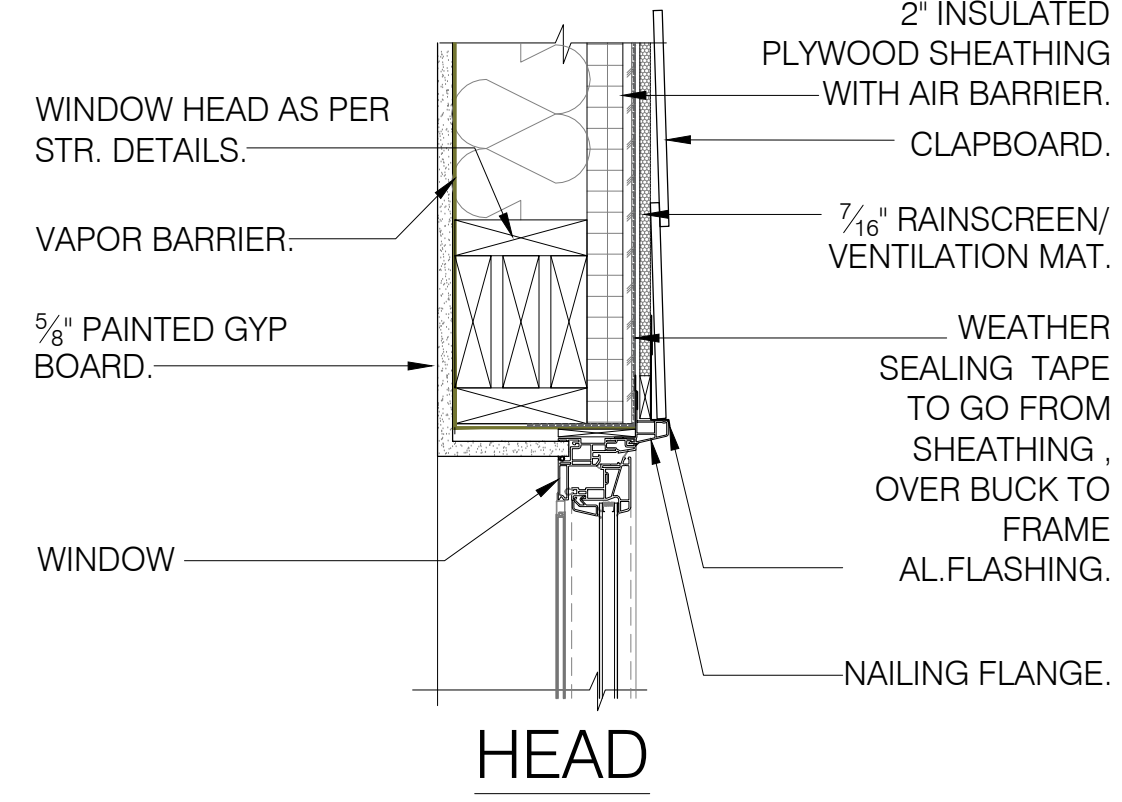

HEAD

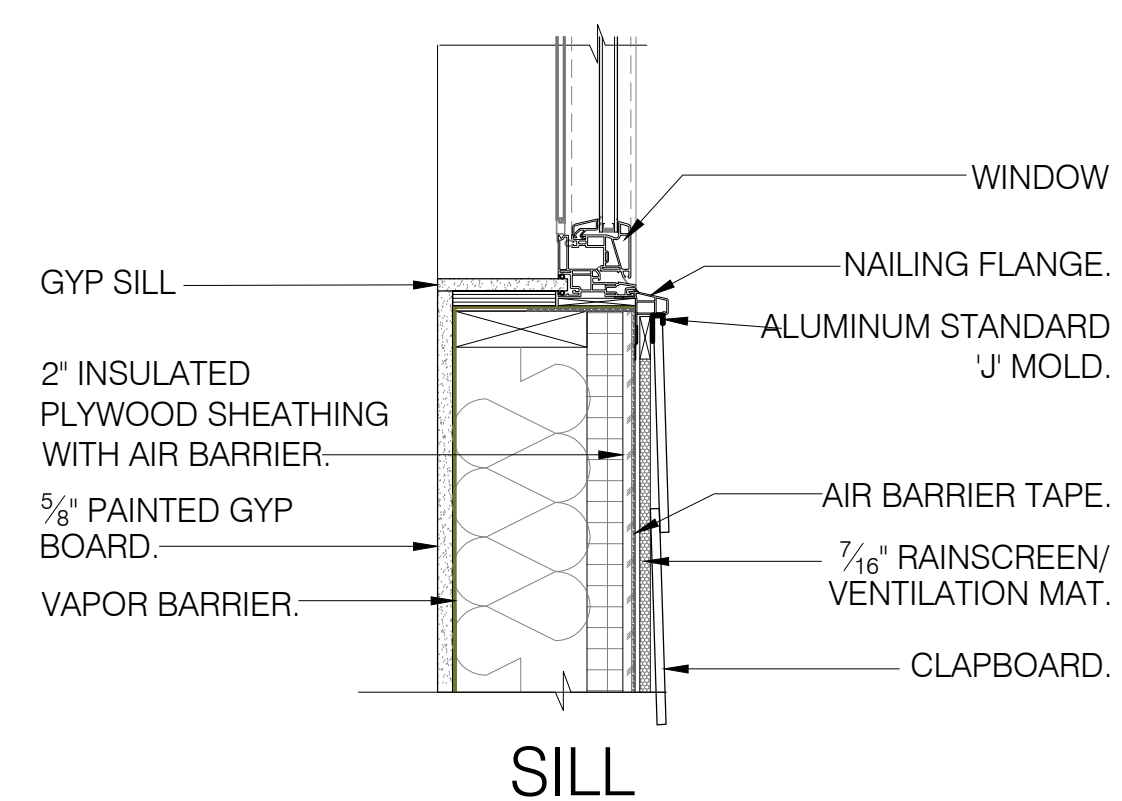

SILL

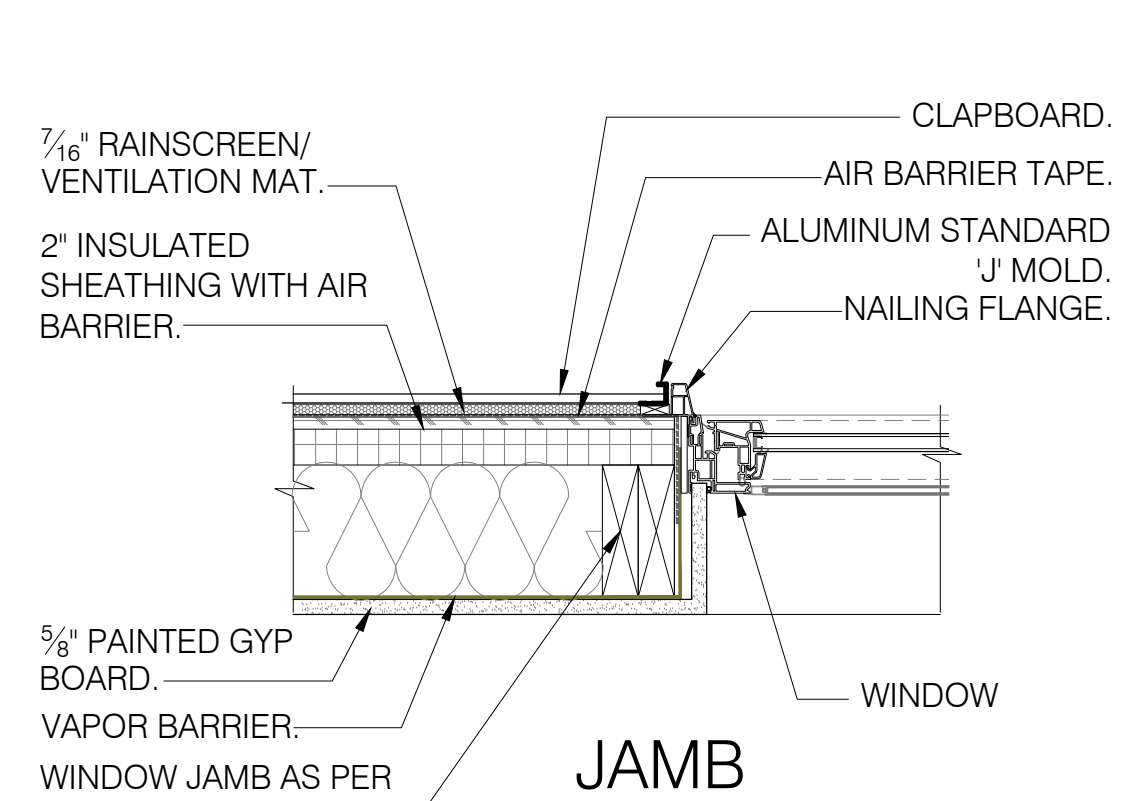

JAMB

2 WINDOW DTLS - TYP.
SCALE: 1-1/2" = 1'-0"

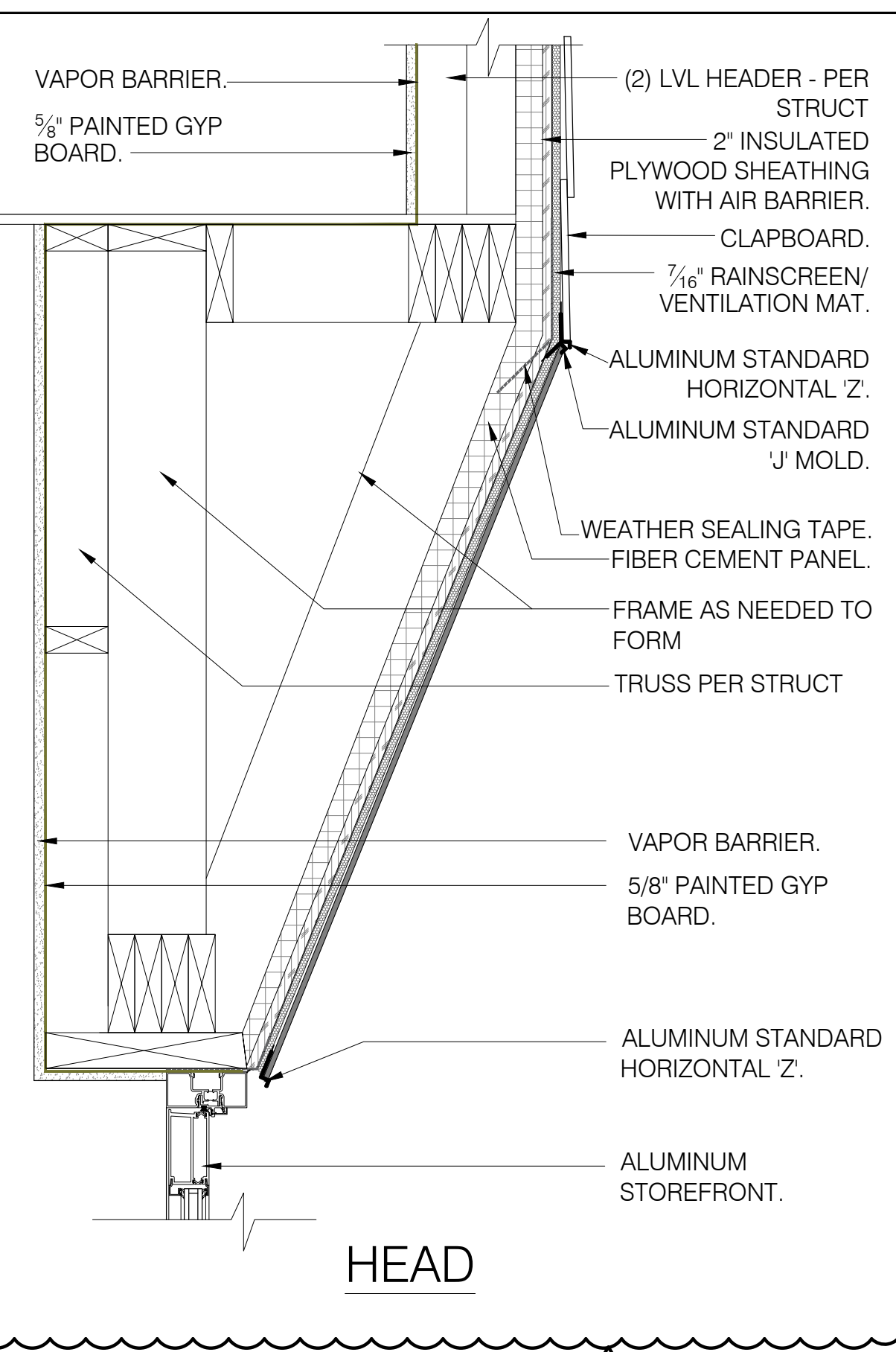

HEAD

3 STOREFRONT DTLS - TYP.
SCALE: 1-1/2" = 1'-0"

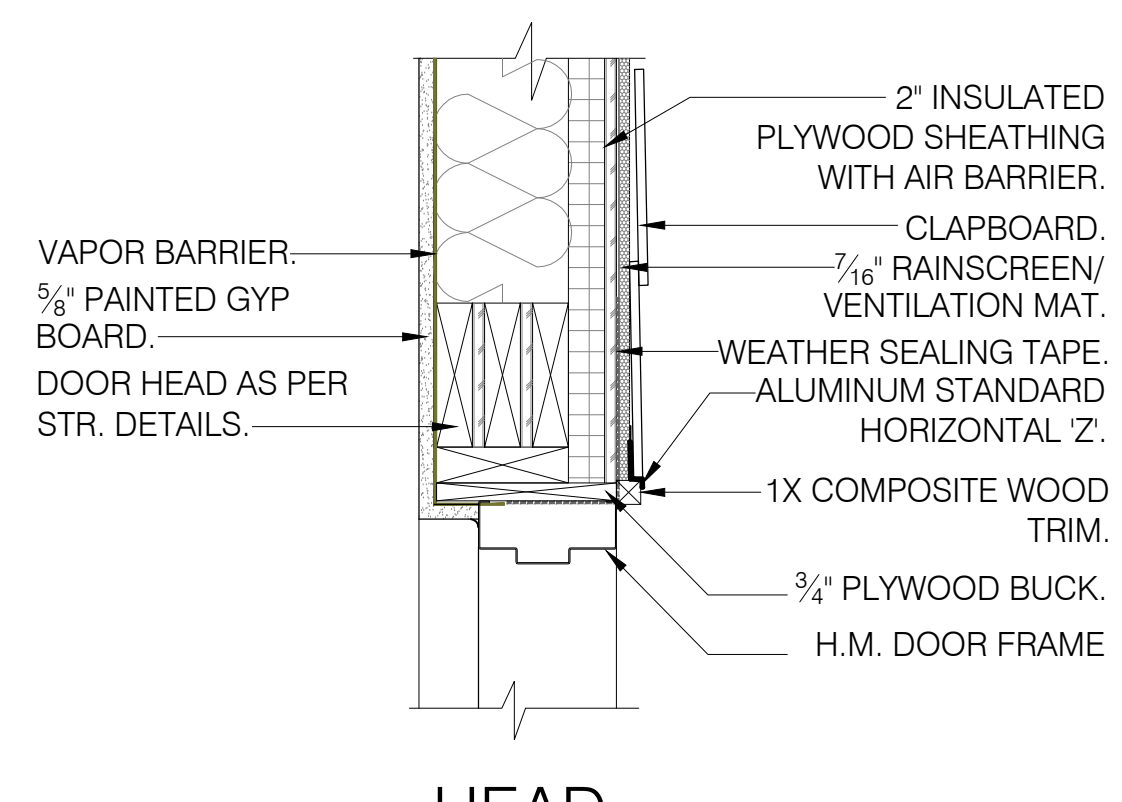

HEAD



JAMB

4 HM EXTERIOR DOOR DTLS - TYP.
SCALE: 1-1/2" = 1'-0"

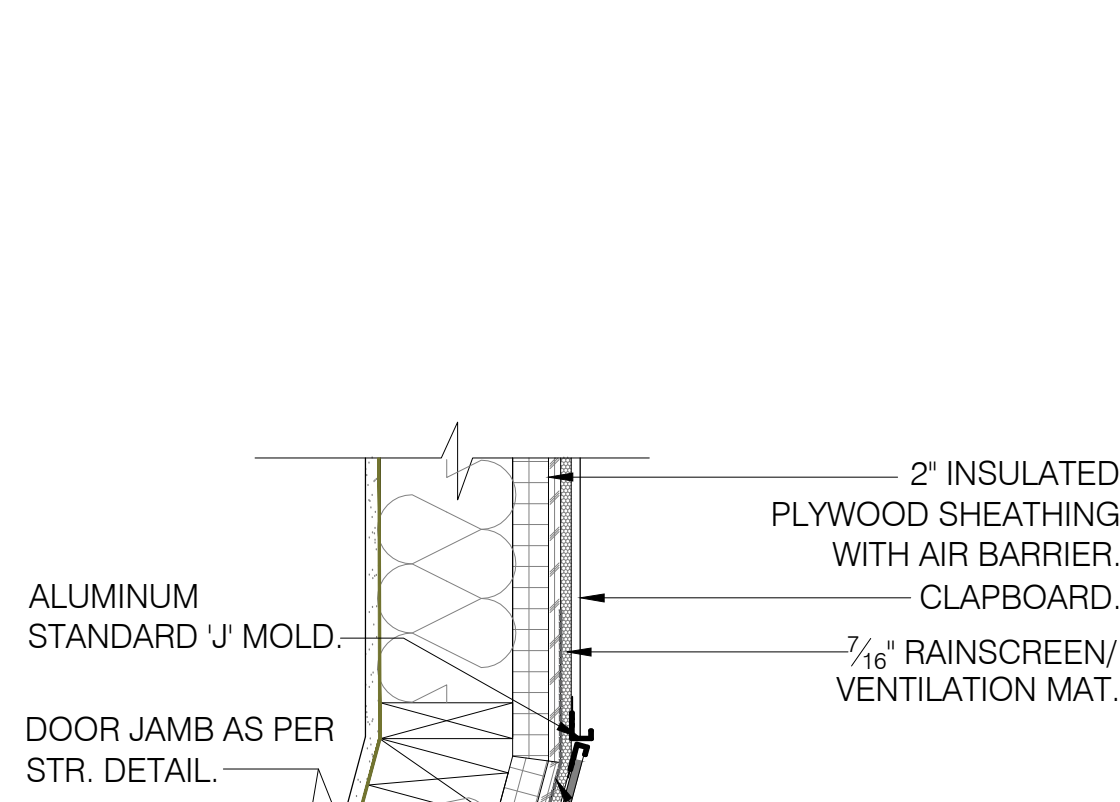

HEAD

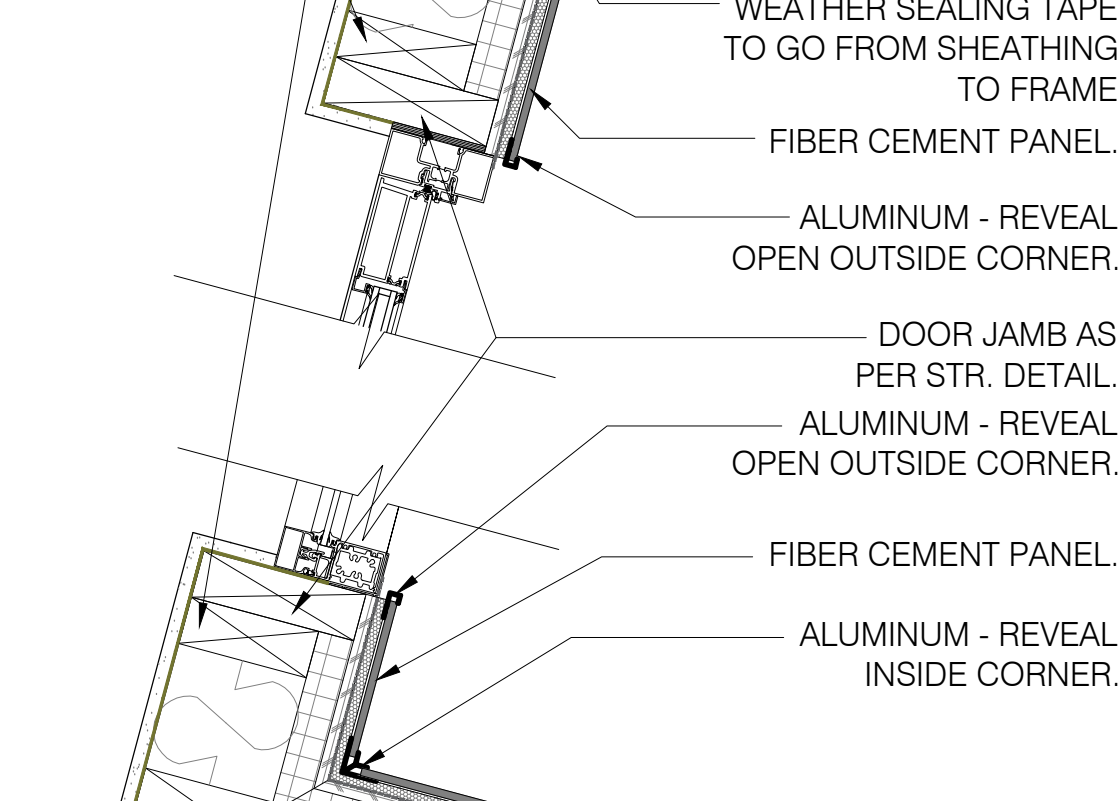

5 ANGLED DOOR DTLS - TYP.
SCALE: 1-1/2" = 1'-0"

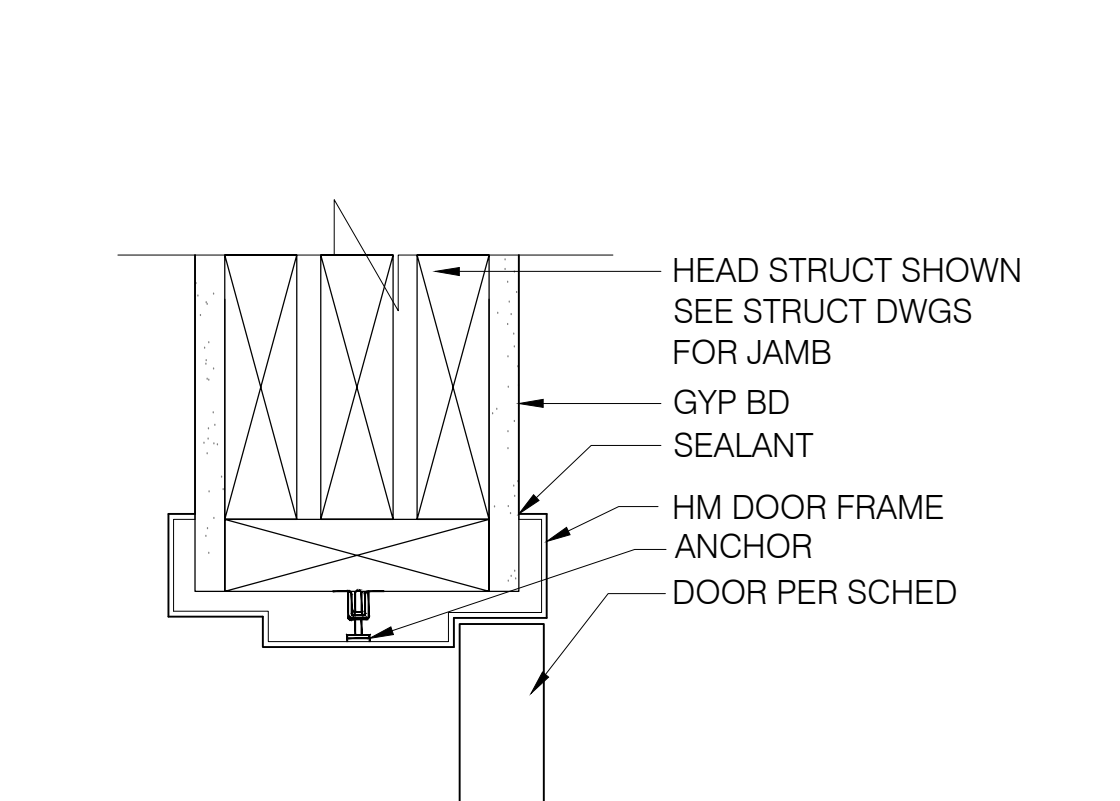

6 INTERIOR DOOR HEAD/JAMB DTL
SCALE: 1-1/2" = 1'-0"

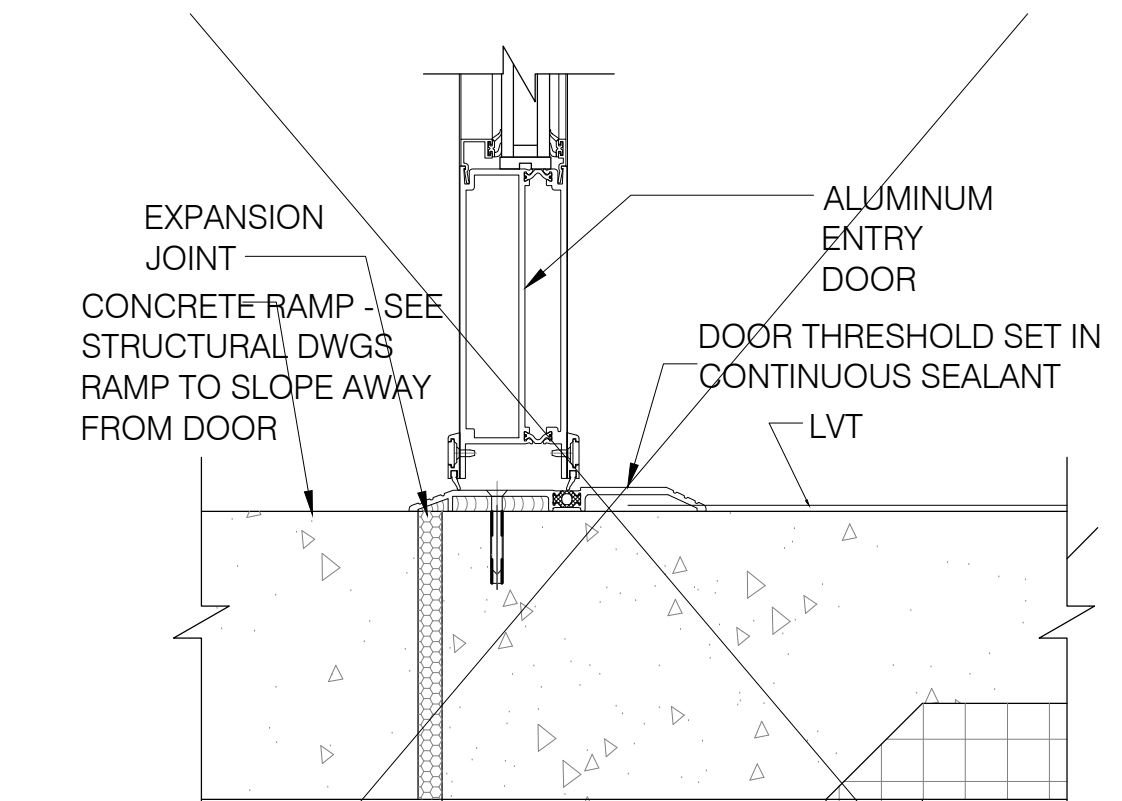

7 EXTERIOR DOOR SILL
SCALE: 3" = 1'-0"

8 NOT USED
SCALE: 1-1/2" = 1'-0"

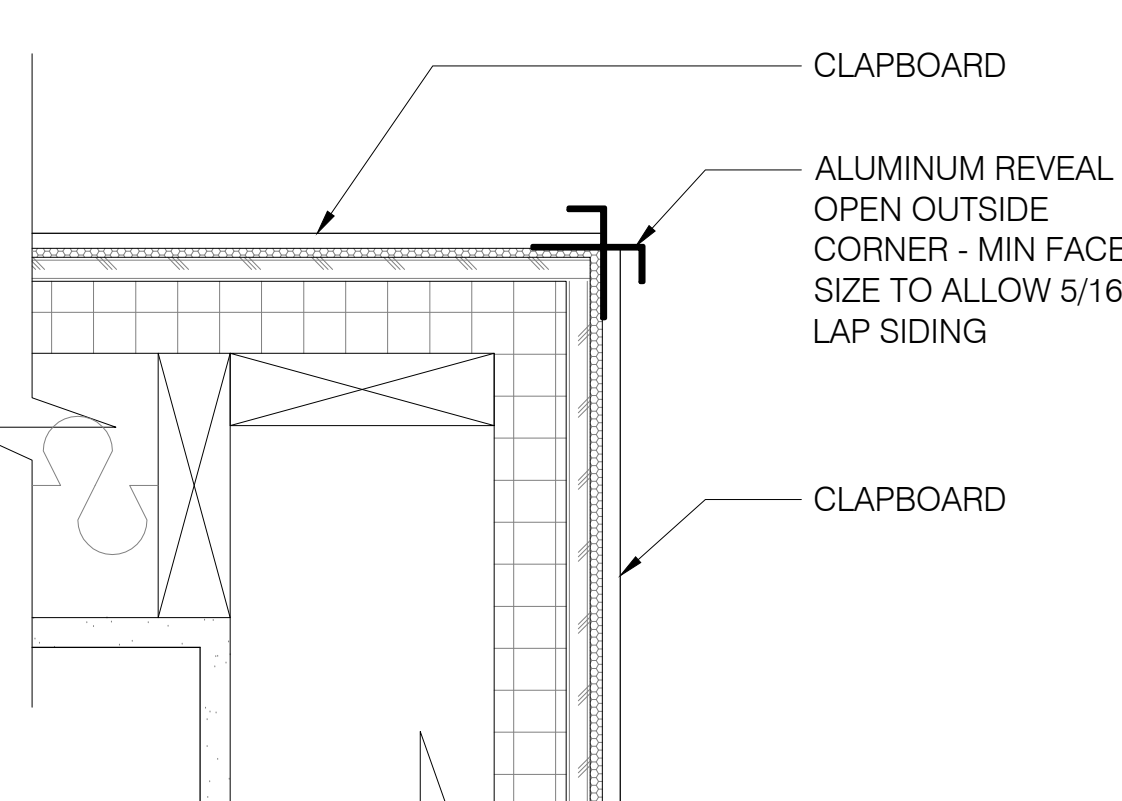

9 CORNER DETAIL
SCALE: 1-1/2" = 1'-0"

10 NOT USED
SCALE: 1-1/2" = 1'-0"

Bild Architecture
PO Box 8235
Portland, ME
04104
207.408.0168
evan@bildarchitecture.com

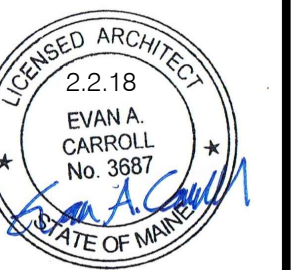

PROJECT NO. **16040**
PROJECT NAME **MIXED-USE SHELL**
50 COVE STREET, PORTLAND ME - 04101

ISSUE DATE **2/2/18**
SHEET SCALE **AS NOTED**

PERMITTING DRAWINGS
DRAWN BY **EMW**
SHEET TITLE **DOOR & WINDOW DETAILS**

REVISIONS
1 02.27.2018
2
3
4
5

A
5.0