

J W.C. 305
SCALE: 1/4" = 1'-0"

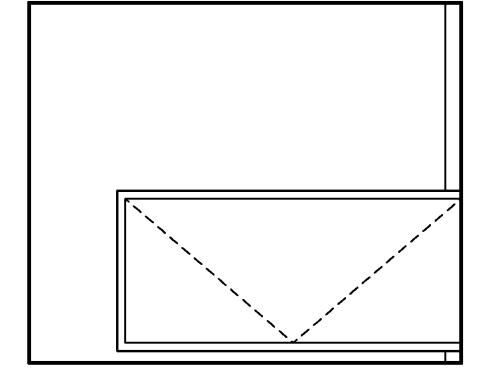

1 W.C. 305
SCALE: 1/4" = 1'-0"

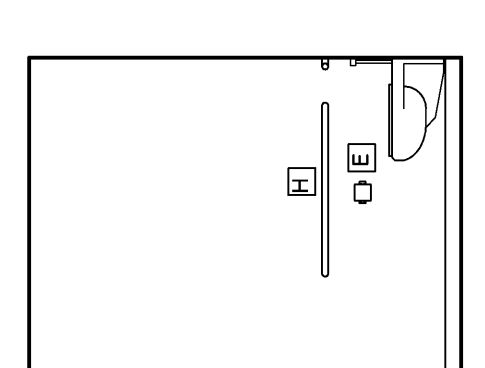

2 W.C. 305
SCALE: 1/4" = 1'-0"

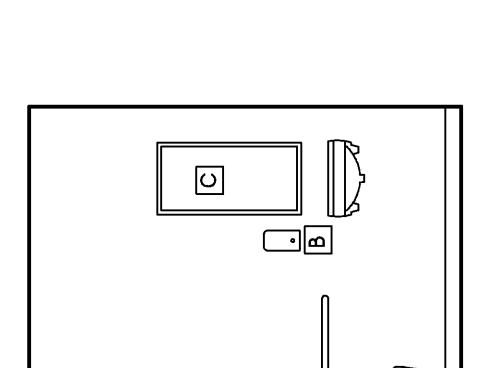

3 W.C. 305
SCALE: 1/4" = 1'-0"

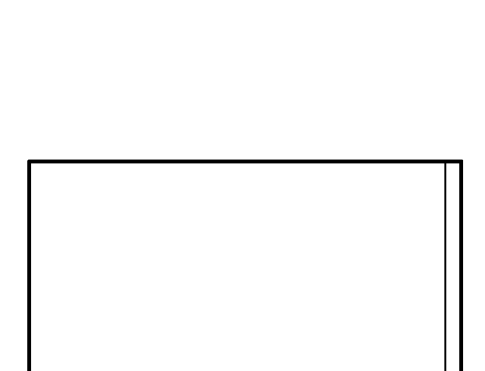

4 W.C. 305
SCALE: 1/4" = 1'-0"

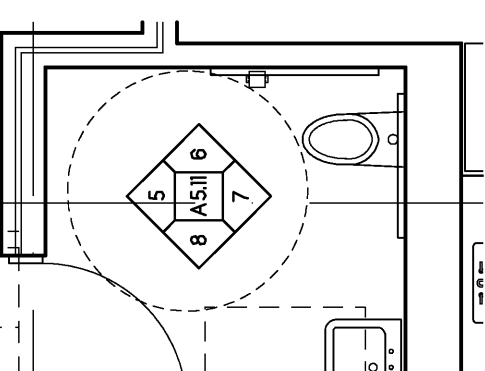

K STAFF W.C. 310
SCALE: 1/4" = 1'-0"

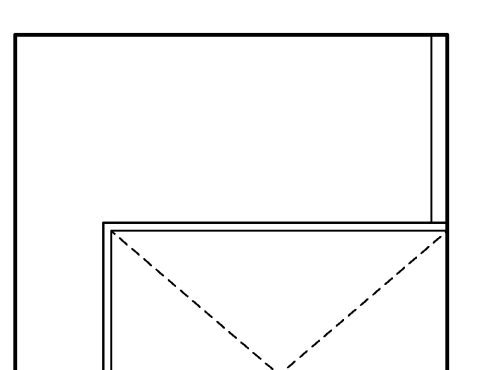

5 STAFF W.C. 310
SCALE: 1/4" = 1'-0"

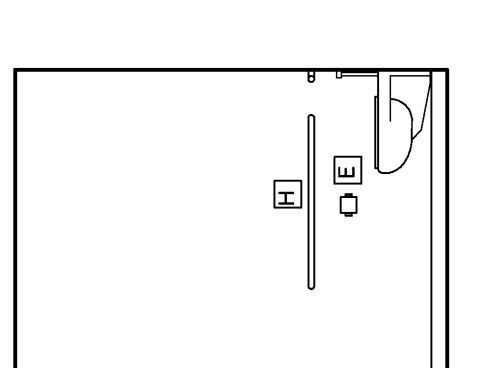

6 STAFF W.C. 310
SCALE: 1/4" = 1'-0"

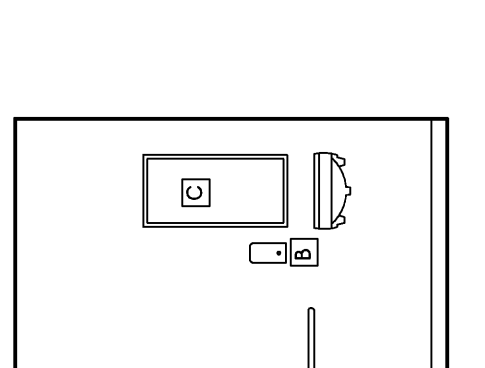

7 STAFF W.C. 310
SCALE: 1/4" = 1'-0"

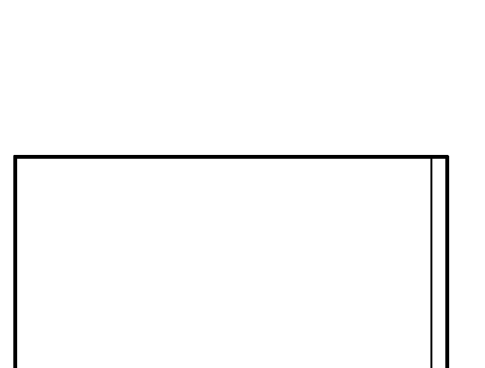

8 STAFF W.C. 310
SCALE: 1/4" = 1'-0"

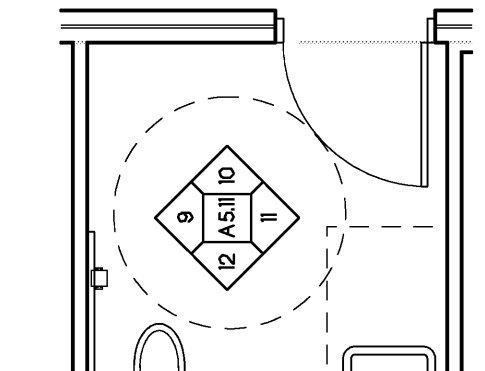

L STAFF W.C. 310
SCALE: 1/4" = 1'-0"

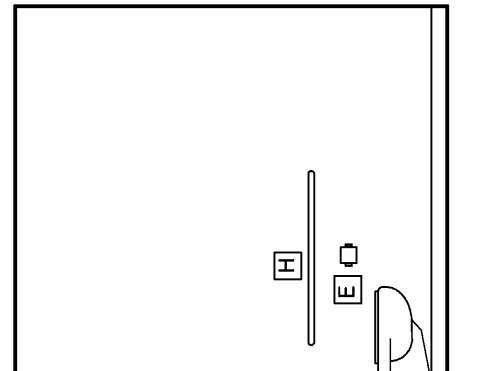

9 STAFF W.C. 310
SCALE: 1/4" = 1'-0"

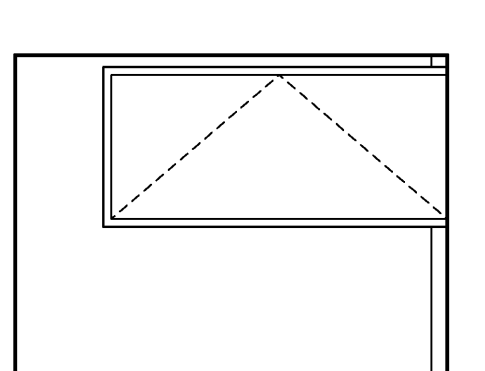

10 STAFF W.C. 310
SCALE: 1/4" = 1'-0"

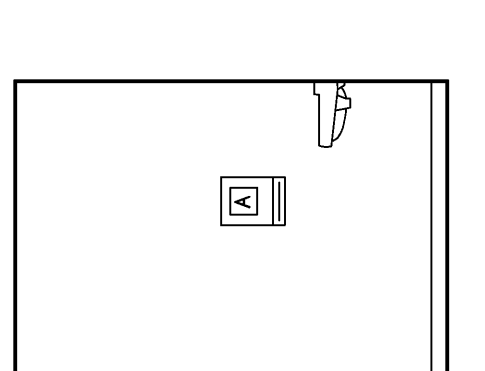

11 STAFF W.C. 310
SCALE: 1/4" = 1'-0"

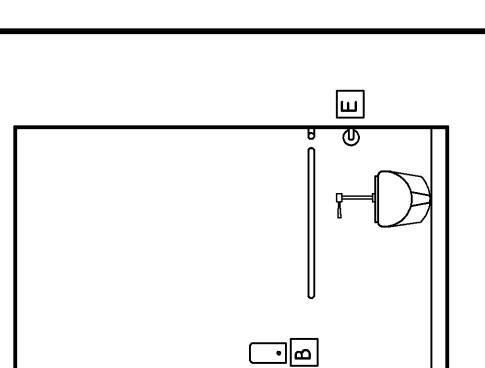

12 STAFF W.C. 310
SCALE: 1/4" = 1'-0"

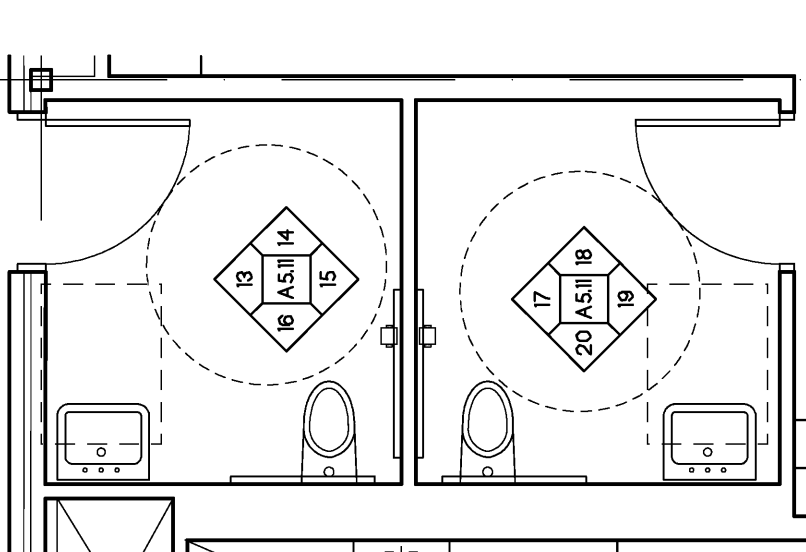

M W.C. 228, 242, 255
SCALE: 1/4" = 1'-0"

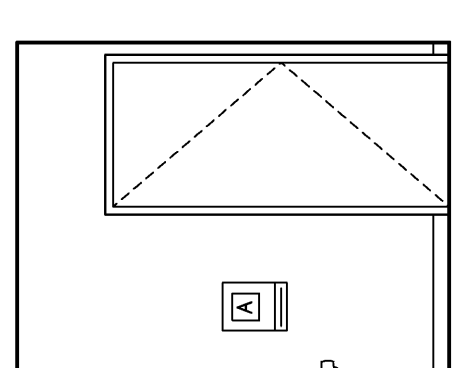

13 W.C. 228, 242, 255
SCALE: 1/4" = 1'-0"

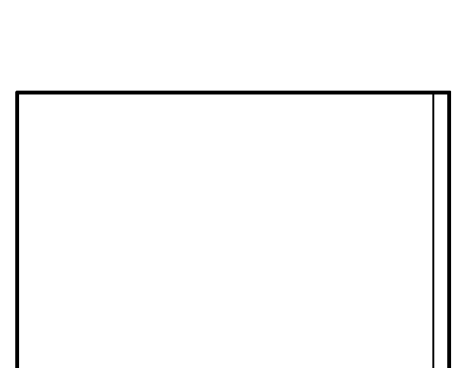

14 W.C. 228, 242, 255
SCALE: 1/4" = 1'-0"

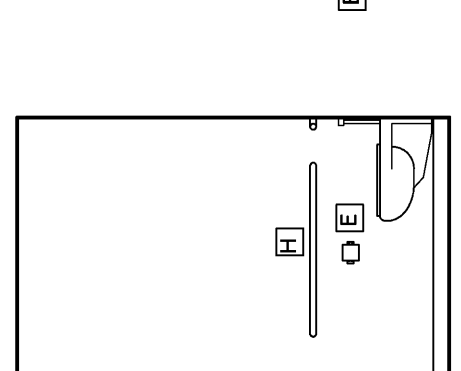

15 W.C. 228, 242, 255
SCALE: 1/4" = 1'-0"

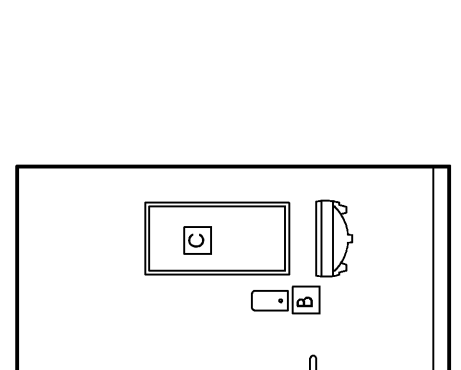

16 W.C. 228, 242, 255
SCALE: 1/4" = 1'-0"

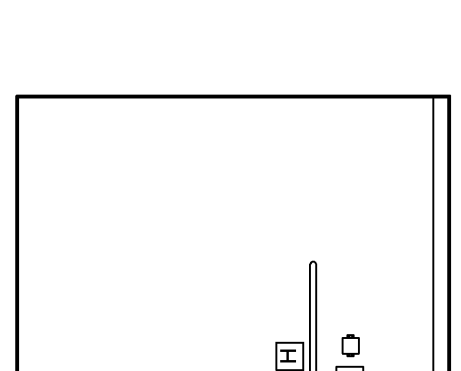

17 W.C. 228, 242, 255
SCALE: 1/4" = 1'-0"



18 W.C. 228, 242, 255
SCALE: 1/4" = 1'-0"

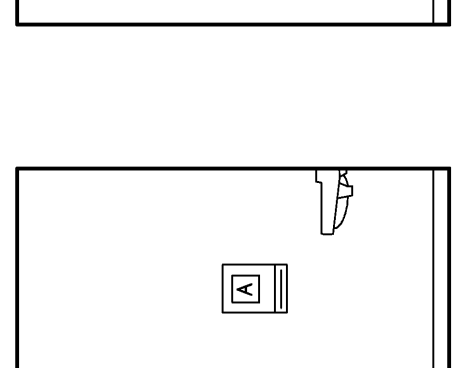

19 W.C. 228, 242, 255
SCALE: 1/4" = 1'-0"

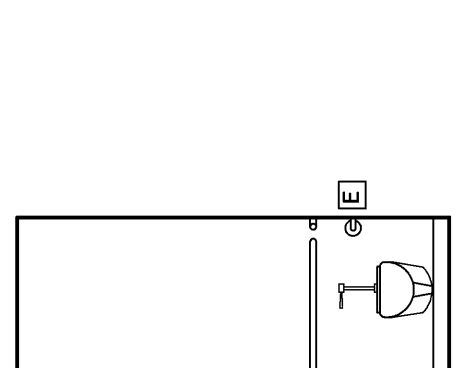

20 W.C. 228, 242, 255
SCALE: 1/4" = 1'-0"

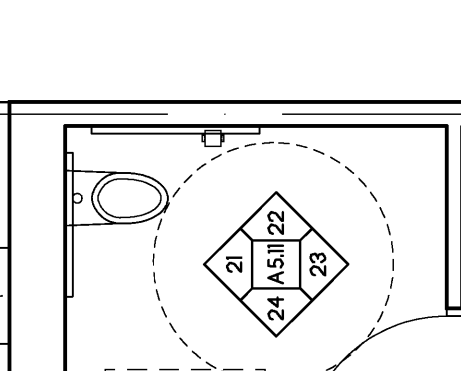

21 W.C. 228, 242, 255
SCALE: 1/4" = 1'-0"

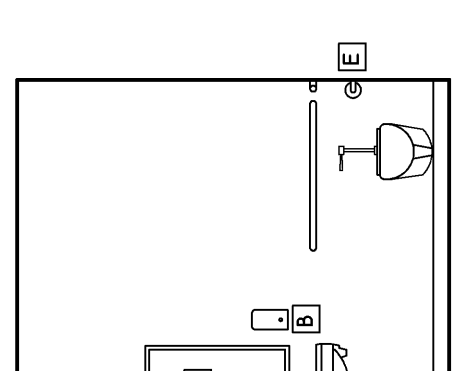

22 W.C. 228, 242, 255
SCALE: 1/4" = 1'-0"

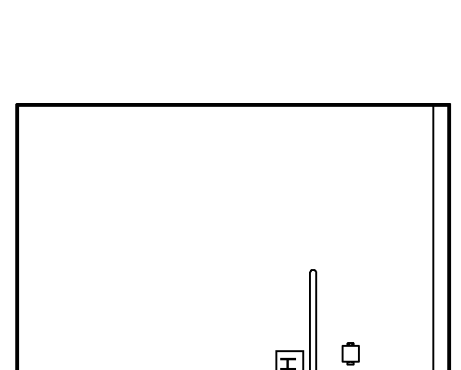

23 W.C. 228, 242, 255
SCALE: 1/4" = 1'-0"

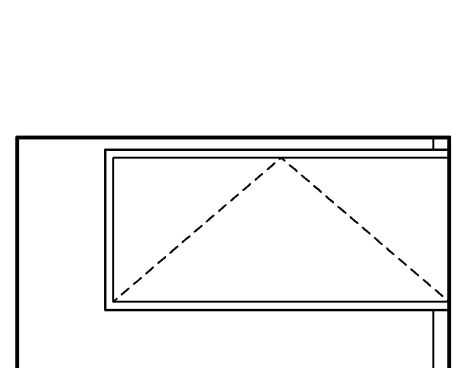

24 W.C. 228, 242, 255
SCALE: 1/4" = 1'-0"

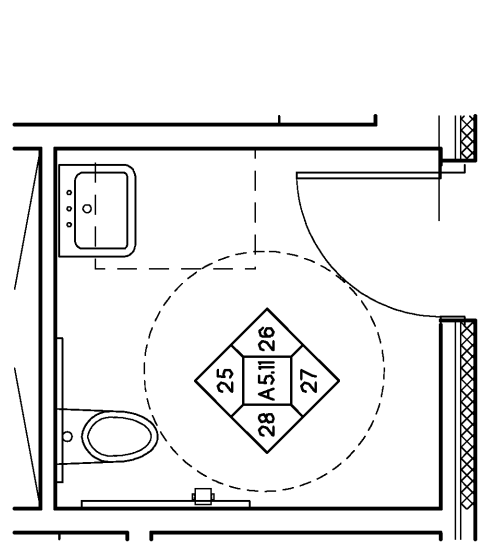

O W.C. 228, 242, 255
SCALE: 1/4" = 1'-0"

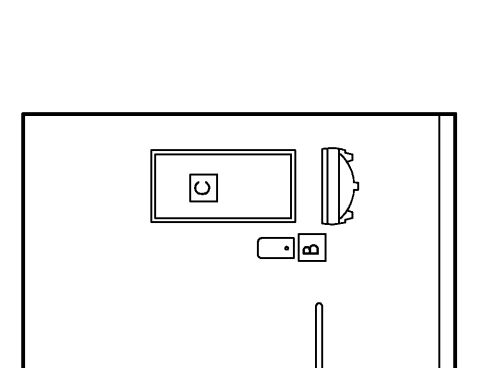

25 W.C. 228, 242, 255
SCALE: 1/4" = 1'-0"

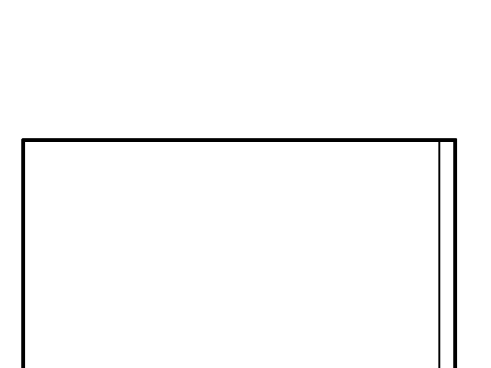

26 W.C. 228, 242, 255
SCALE: 1/4" = 1'-0"

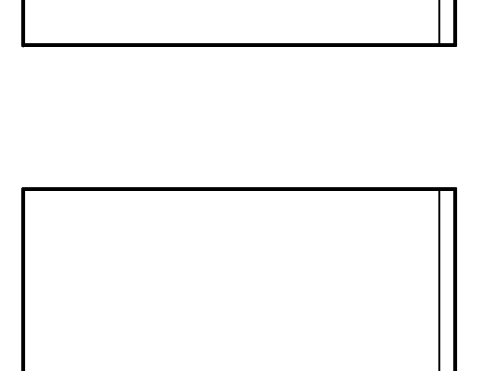

27 W.C. 228, 242, 255
SCALE: 1/4" = 1'-0"

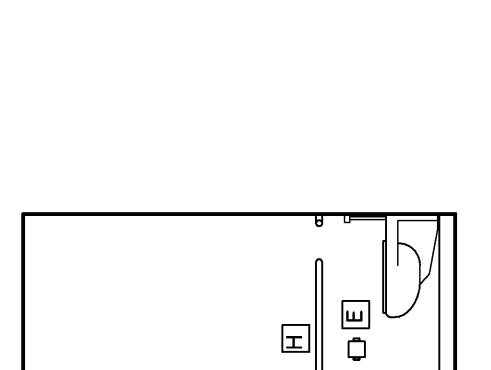

28 W.C. 228, 242, 255
SCALE: 1/4" = 1'-0"

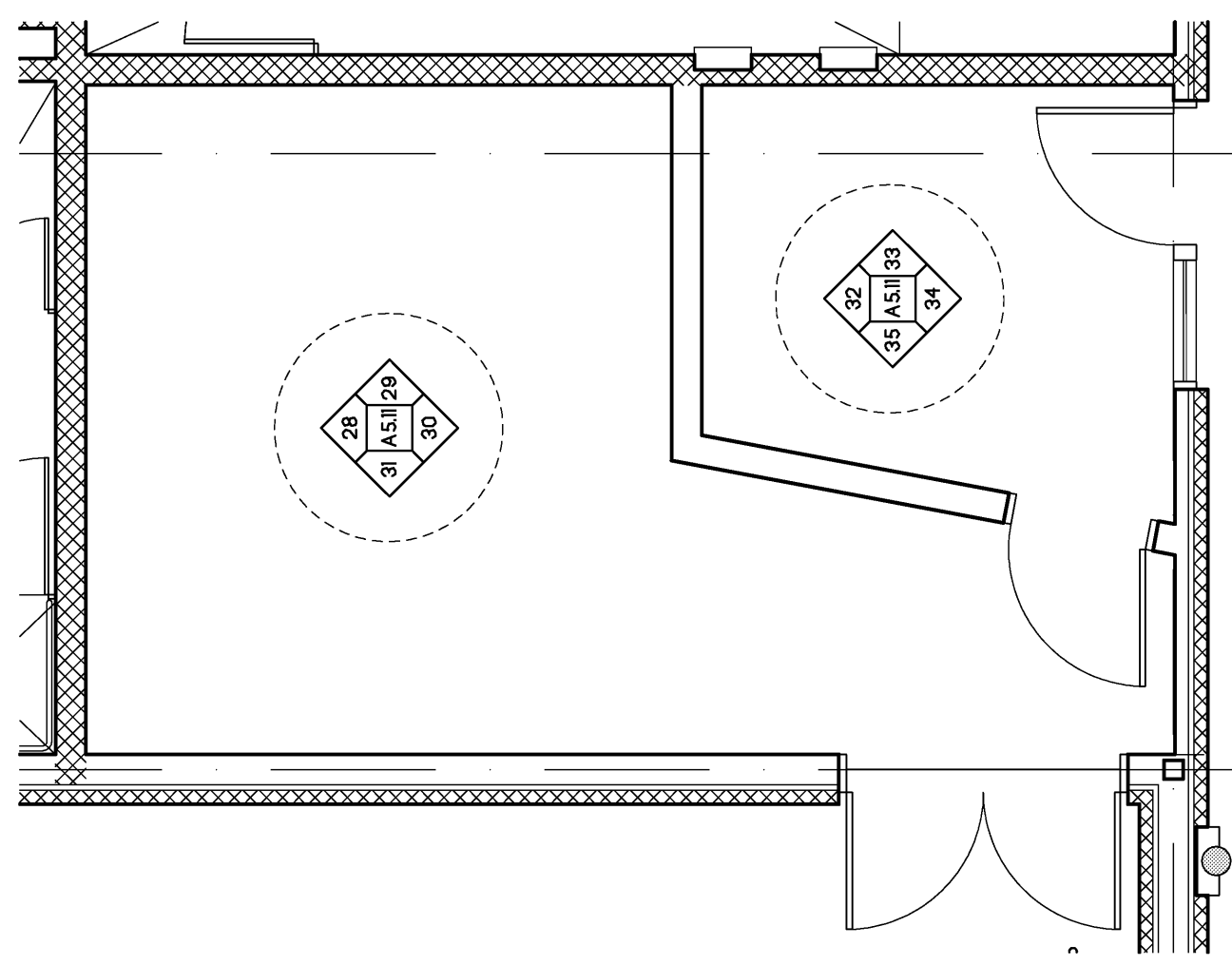

P REC. OFFICE 328
SCALE: 1/4" = 1'-0"

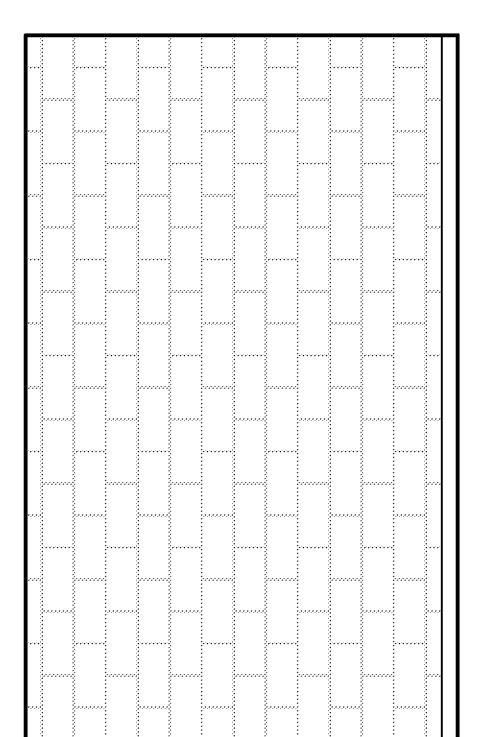

28 REC. OFFICE 328
SCALE: 1/4" = 1'-0"

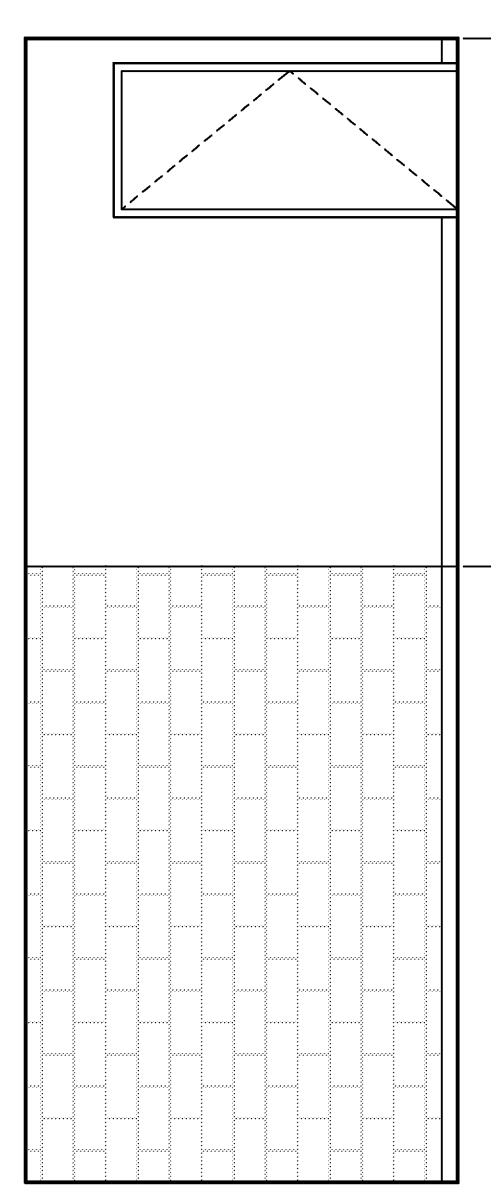

29 REC. OFFICE 328
SCALE: 1/4" = 1'-0"

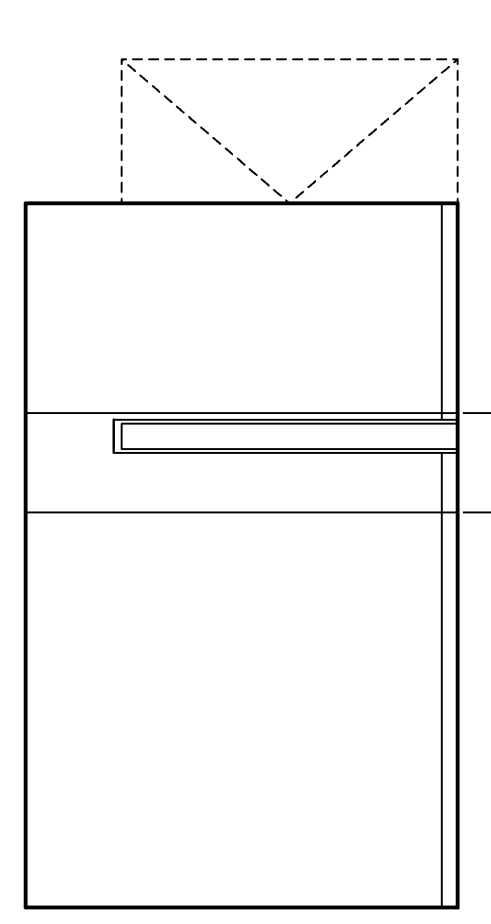

30 REC. OFFICE 328
SCALE: 1/4" = 1'-0"

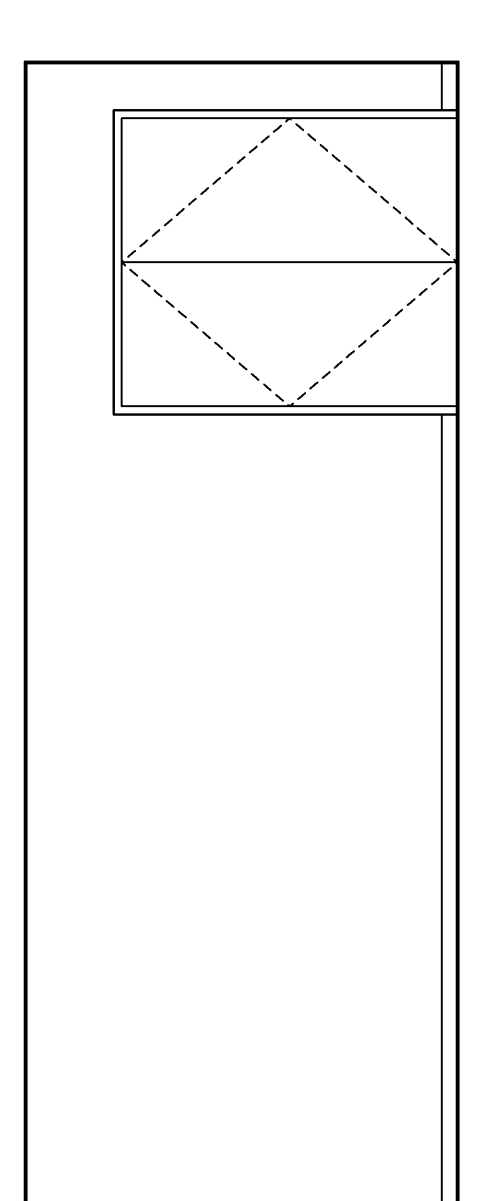

31 REC. OFFICE 328
SCALE: 1/4" = 1'-0"

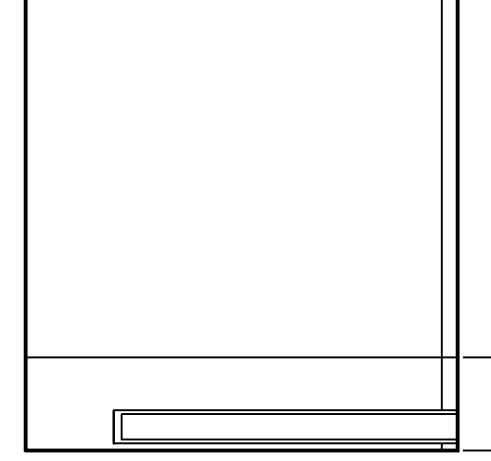

32 REC. OFFICE 328
SCALE: 1/4" = 1'-0"

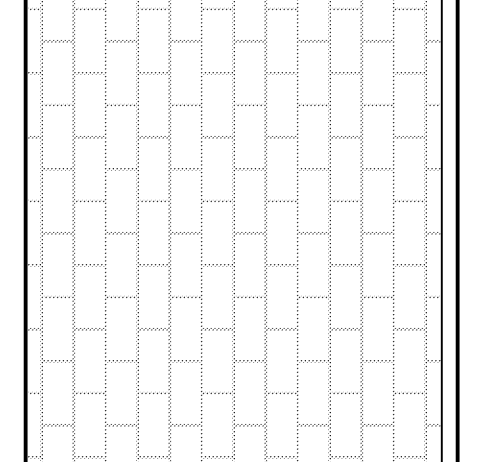

33 REC. OFFICE 328
SCALE: 1/4" = 1'-0"

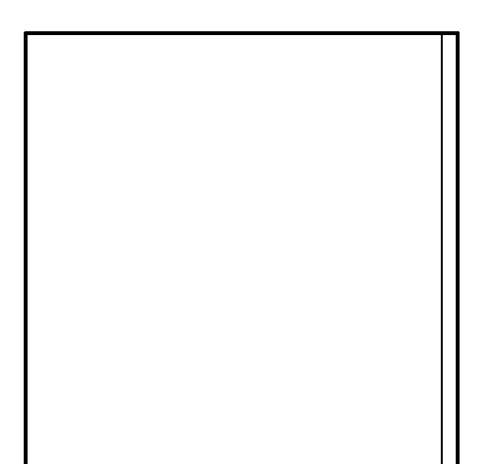

34 REC. OFFICE 328
SCALE: 1/4" = 1'-0"

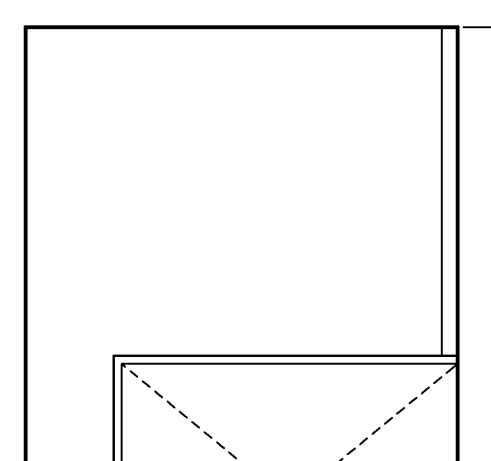

35 REC. OFFICE 328
SCALE: 1/4" = 1'-0"

	<p>East End Elementary School Portland Public Schools Portland, Maine</p>
	<p>Project No.: 0309 Date: July 15, 2004 Scale: 1/4" = 1'-0" Drawn by: reg Checked by: jph</p>
<p>Consultants Civil Engineer Landscape Architect Structural Engineer Mechanical Engineer Electrical Engineer Barricade Design Interior Elevations TJM Consulting Green Consultants Fore Solutions</p>	<p>Deluca-Hoffman Associates Civil Engineer Landscape Architect Structural Engineer Mechanical Engineer Electrical Engineer Barricade Design Interior Elevations TJM Consulting Green Consultants Fore Solutions</p>
<p>10 Duaneville Street Portland, ME 04103 Phone: 603.761.2051 Fax: 603.761.2105 www.dhassociates.com</p>	<p>A5.11</p>