

MXS32GVJU

OUTDOOR UNIT

DAIKIN

3P207257-3D M07B061D



DAIKIN AIR-CONDITIONER

INSTALLATION MANUAL



Two-dimensional bar code
is a code for manufacturing.

Safety Precautions (1)

- Read these Safety Precautions carefully to ensure correct installation.
- This manual classifies the precautions into DANGER, WARNING and CAUTION. Be sure to follow all the precautions below: they are all important for ensuring safety.

 DANGER	Indicates an imminently hazardous situation which, if not avoided, will result in death or serious injury.
 WARNING	Failure to follow any of WARNING is likely to result in such grave consequences as death or serious injury.
 CAUTION	Failure to follow any of CAUTION may in some cases result in grave consequences.

- The following safety symbols are used throughout this manual:

	Be sure to observe this instruction.		Be sure to establish a ground connection.		Never attempt.
---	--------------------------------------	---	---	---	----------------

- After completing installation, test the unit to check for installation errors. Give the user adequate instructions concerning the use and cleaning of the unit according to the Operation Manual.

DANGER

- Refrigerant gas is heavier than air and replaces oxygen. A massive leak could lead to oxygen depletion, especially in basements, and an asphyxiation hazard could occur leading to serious injury or death.
- If the refrigerant gas leaks during installation, ventilate the area immediately.
Refrigerant gas may produce a toxic gas if it comes in contact with fire such as from a fan heater, stove or cooking device.
Exposure to this gas could cause severe injury or death.
- After completing the installation work, check that the refrigerant gas does not leak.
Refrigerant gas may produce a toxic gas if it comes in contact with fire such as from a fan heater, stove or cooking device.
Exposure to this gas could cause severe injury or death.
- Do not ground units to water pipes, telephone wires or lightning rods because incomplete grounding could cause a severe shock hazard resulting in severe injury or death, and to gas pipes because a gas leak could result in an explosion which could lead to severe injury or death.
- Safely dispose of the packing materials.
Packing materials, such as nails and other metal or wooden parts, may cause stabs or other injuries.
Tear apart and throw away plastic packaging bags so that children will not play with them.
Children playing with plastic bags face the danger of death by suffocation.
- Do not install unit in an area where flammable materials are present due to risk of explosion resulting in serious injury or death.
- Do not ground units to telephone wires or lightning rods because lightning strikes could cause a severe shock hazard resulting in severe injury or death, and to gas pipes because a gas leak could result in an explosion which could lead to severe injury or death.

Safety Precautions (2)





WARNING

- Installation should be left to the authorized dealer or another trained professional.
Improper installation may cause water leakage, electrical shock, fire, or equipment damage.
- Install the air conditioner according to the instructions given in this manual.
Incomplete installation may cause water leakage, electrical shock, fire or equipment damage.
- Be sure to use the supplied or exact specified installation parts.
Use of other parts may cause the unit to come to fall, water leakage, electrical shock, fire or equipment damage.
- Install the air conditioner on a solid base that is level and can support the weight of the unit.
An inadequate base or incomplete installation may cause injury or equipment damage in the event the unit falls off the base or comes loose.
- Electrical work should be carried out in accordance with the installation manual and the national, state and local electrical wiring codes.
Insufficient capacity or incomplete electrical work may cause electrical shock, fire or equipment damage.
- Be sure to use a dedicated power circuit. Never use a power supply shared by another appliance.
Follow all appropriate electrical codes.
- For wiring, use a wire or cable long enough to cover the entire distance with no splices if possible.
Do not use an extension cord. Do not put other loads on the power supply.
Use an only a separate dedicated power circuit.
(Failure to do so may cause abnormal heat, electric shock, fire or equipment damage.)
- Use the specified types of wires for electrical connections between the indoor and outdoor units.
Follow all state and local electrical codes.
Firmly clamp the interconnecting wires so their terminals receive no external stresses.
Incomplete connections or clamping may cause terminal overheating, fire or equipment damage.
- After connecting all wiring be sure to shape the cables so that they do not put undue stress on the electrical covers, panels or terminals.
Install covers over the wires. Incomplete cover installation may cause terminal overheating, electrical shock, fire or equipment damage.
- When installing or relocating the system, be sure to keep the refrigerant circuit free from all substances other than the specified refrigerant (R410A), such as air.
(Any presence of air or other foreign substance in the refrigerant circuit causes an abnormal pressure rise which may result in rupture, resulting in injury.)
- During pump-down, stop the compressor before removing the refrigerant piping.
If the compressor is still running and the stop valve is open during pump-down, air will be sucked in when the refrigerant piping is removed, causing abnormally high pressure which could lead to equipment damage or and personal injury.
- During installation, attach the refrigerant piping securely before running the compressor.
If the compressor is not attached and the stop valve is open during pump-down, air will be sucked in when the compressor is run, causing abnormally high pressure which could lead to equipment damage and personal injury.
- Install a leak circuit breaker, as required.
If a leak circuit breaker is not installed, electric shock may result.
- Be sure to install a ground fault circuit interrupter breaker.
Failure to install a ground fault circuit interrupter breaker may result in electrically shocks, or fire personal injury.



CAUTION

- Do not install the air conditioner where gas leakage would be exposed to open flames.
If the gas leaks and builds up around the unit, it may catch fire. 
- Establish drain piping according to the instructions of this manual.
Inadequate piping may cause water damage.
- Tighten the flare nut according to the specified torque. A torque wrench should be used.
If the flare nut is tightened too much, the flare nut may crack over time and cause refrigerant leakage.
- Do not touch the heat exchanger fins.
Improper handling may result in injury. 
- Be very careful about product transportation.
Some products use PP bands for packaging. Do not use any PP bands for a means of transportation. It is dangerous.
- Make sure to provide for adequate measures in order to prevent that the outdoor unit be used as a shelter by small animals.
Small animals making contact with electrical parts can cause malfunctions, smoke or fire. Please instruct the customer to keep the area around the unit clean.

Accessories

Accessories supplied with the outdoor unit:

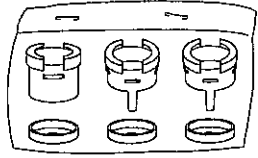
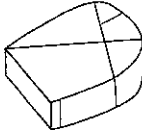
(A) Installation manual	1	(B) Drain socket assy 	1	(C) Reducer assy 	1
-------------------------	---	--	---	---	---

Precautions for Selecting the Location

OUTDOOR UNIT

- 1) Choose a place solid enough to bear the weight and vibration of the unit, where the operation noise will not be amplified.
- 2) Choose a location where the hot air discharged from the unit or the operation noise will not cause a nuisance to the neighbors of the user.
- 3) Avoid installing near bedrooms where operation noise might be a nuisance.
- 4) There must be sufficient spaces for carrying the unit into and out of the site.
- 5) There must be sufficient space for air passage and no obstructions around the air inlet and the air outlet.
- 6) The site must be free from the possibility of flammable gas leakage in a nearby place.
- 7) Install units, power cords, and inter-unit cables at least 9.8 feet from television and radios to prevent interference. Noises may be heard even if more than 9.8 feet away, depending on radio wave conditions.
- 8) In coastal areas or other places with salty atmosphere of sulfate gas, corrosion may shorten the life of the air conditioner.
- 9) Since drain flows out of the outdoor unit, do not place under the unit anything which must be kept away from moisture.

NOTE

Cannot be installed hanging from ceiling or stacked.

CAUTION

When operating the air conditioner in a low outdoor ambient temperature, be sure to follow the instructions described below.

- 1) To prevent exposure to wind, install the outdoor unit with its suction side facing the wall.
- 2) Never install the outdoor unit at a site where the suction side may be exposed directly to wind.
- 3) To prevent exposure to wind, it is recommended to install a baffle plate on the air discharge side of the outdoor unit.
- 4) In heavy snowfall areas, select an installation site where the snow will not affect the unit.



- Construct a large canopy.
- Construct a pedestal.

Install the unit high enough off the ground to prevent burying in snow.

Indoor/Outdoor Unit Installation Drawings

For installation of the indoor units, refer to the installation manual which was provided with the units.
(The diagram shows a wall-mounted indoor unit.)

⚠ CAUTION

- 1) Do not connect the embedded branch piping and the outdoor unit when only carrying out piping work without connecting the indoor unit in order to add another indoor unit later.
Make sure no dirt or moisture gets into either side of the embedded branch piping.
See "7 Refrigerant Piping Work" in "Refrigerant Piping Work (3)" for details.
- 2) It is impossible to connect the indoor unit for one room only. **Be sure to connect at least 2 rooms.**

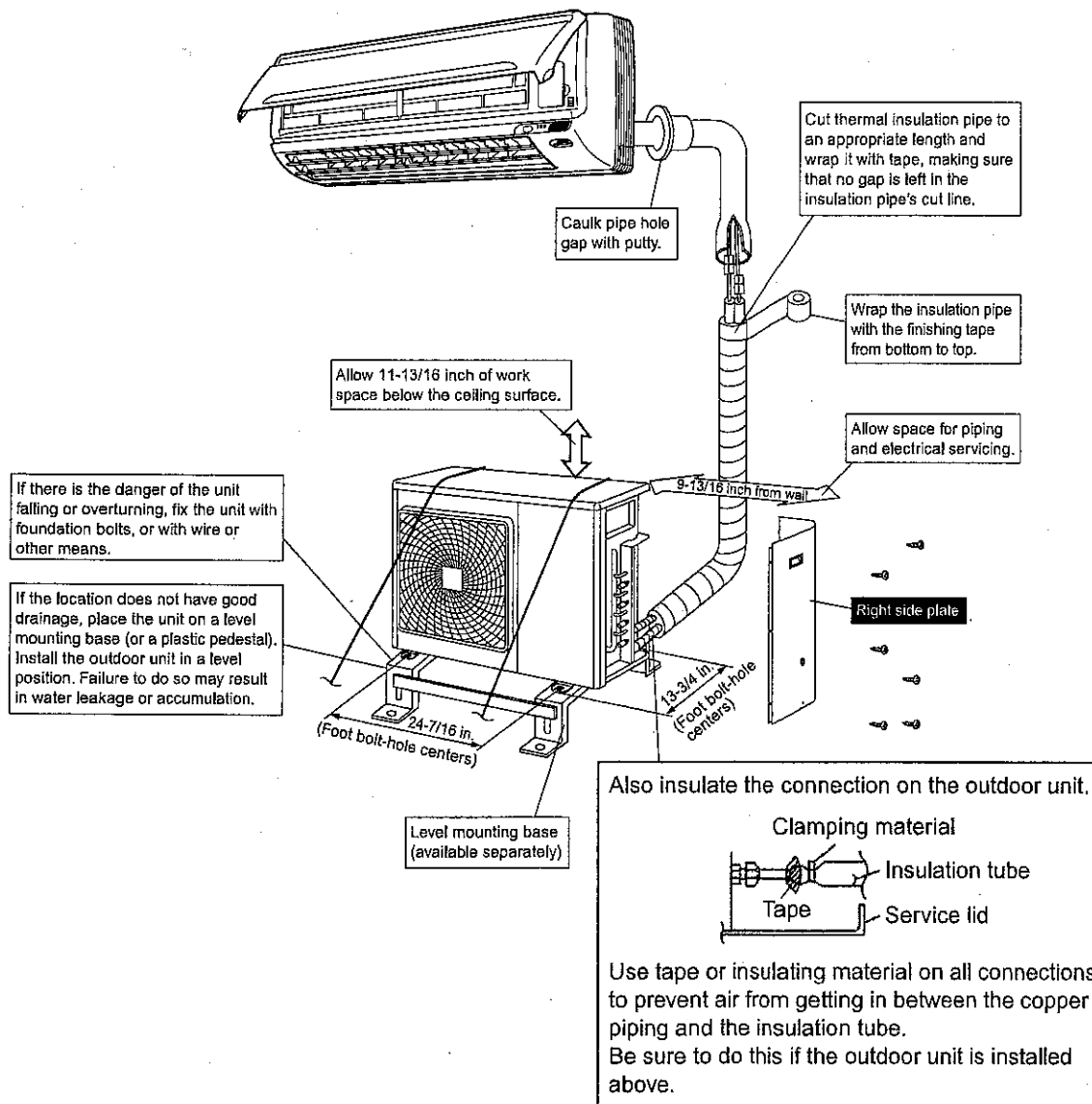

Installation

- Install the unit horizontally.
- The unit may be installed directly on a concrete verandah or a solid surface if drainage is good.
- If the vibration may possibly be transmitted to the building, use a vibration-proof rubber isolator (field supply).

Connections (connection port)

Install the indoor unit according to the table below, which shows the relationship between the class of indoor unit and the corresponding port.

The total indoor unit class that can be connected to this unit:

3MXS24* – Up to 39000 Btu

4MXS32* – Up to 45000 Btu

The line set piping size is determined by the size of the indoor unit fittings.

Reducers are used at the outdoor unit to accommodate the correct gas line pipe size.

Port	3MXS24*	4MXS32*	Reducer numbers
A	07, 09, 12	07, 09, 12	—
B	⓪7, ⓪9, ⓪12, 15, 18	⓪7, ⓪9, ⓪12, 15, 18	⓪ 07, 09 & 12 Use No. 2 & 4 reducers
C	⓪7, ⓪9, ⓪12, ⓪15, ⓪18	⓪7, ⓪9, ⓪12, ⓪15, ⓪18	⓪ 07, 09 & 12 Use No. 5 & 6 reducers 15 & 18 Use No. 1 & 3 reducers
D	—	⓪7, ⓪9, ⓪12, ⓪15, ⓪18	⓪ 07, 09 & 12 Use No. 5 & 6 reducers 15 & 18 Use No. 1 & 3 reducers

Refer to "How to Use Reducers" for information on reducer numbers and their shapes.

Precautions on Installation

- Check the strength and level of the installation ground so that the unit will not cause any operating vibration or noise after installation.
- In accordance with the foundation drawing fix the unit securely by means of the foundation bolts. (Prepare four sets of M12 foundation bolts, nuts and washers each which are available as field supply.)
- It is best to screw in the foundation bolts until their length is 3/4" from the foundation surface.

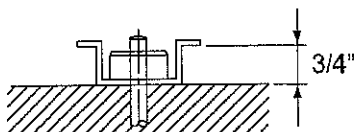

Outdoor Unit Installation Guidelines

- Where a wall or other obstacle is in the path of outdoor unit's intake or exhaust airflow, follow the installation guidelines below.
- For any of the below installation patterns, the wall height on the exhaust side should be 4ft or less.

Wall facing one side

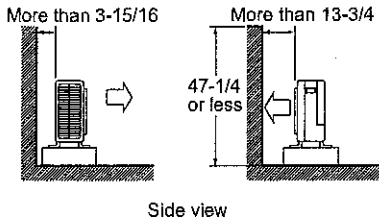

Walls facing two sides

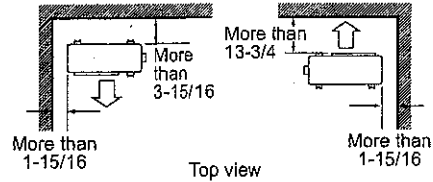

Walls facing three sides

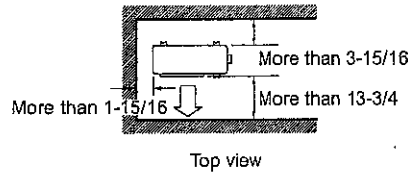

Unit: in.

Selecting a Location for Installation of the Indoor Units

- The maximum allowable length of refrigerant piping, and the maximum allowable height difference between the outdoor and indoor units, are listed below. (The shorter the refrigerant piping, the better the performance. Connect so that the piping is as short as possible. **Shortest allowable length per room is 9.8ft.**)

Outdoor unit capacity class	3MXS24*, 4MXS32*
Piping to each indoor unit	82ft max.
Total length of piping between all units	230ft max.

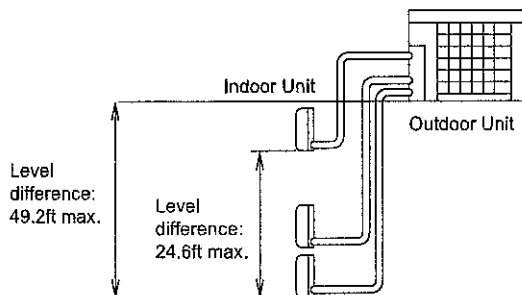

If the outdoor unit is positioned higher than the indoor units.

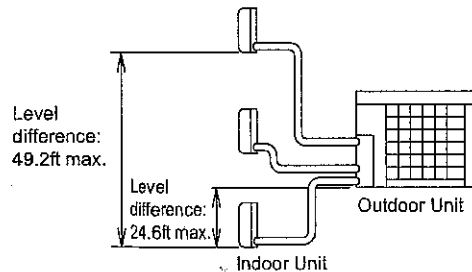

If the outdoor unit is positioned lower than one or more of the indoor units.

Refrigerant Piping Work (1)

1 Installing Outdoor Unit

- When installing the outdoor unit, refer to "Precautions for Selecting the Location" and the "Indoor/Outdoor Unit Installation Drawings".
- If drain work is necessary, follow the procedures below.

2 Drain Work

- Use drain plug for drainage.
- If the drain port is covered by a mounting base or floor surface, place additional foot bases of at least 3-15/16in in height under the outdoor unit's feet.
- In cold areas, do not use a drain hose with the outdoor unit. (Otherwise, drain water may freeze, impairing heating performance.)

1. Insert drain receiver (C) onto drain socket (A) and drain cap (B) beyond 4 projections around drain socket and drain cap.
2. Insert drain socket and drain caps into their matching drain hole ; Drain socket (A) into drain hole I and drain caps (B) into drain hole II and III. After insertion, turn them about 40° clockwise.

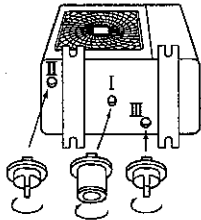

Be sure to insert sockets and caps into their proper drain holes to prevent water leakage.

(View from bottom)

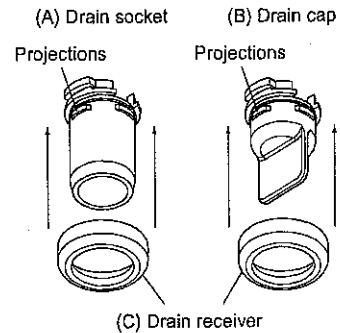

NOTE

Check that the drain receiver (C) is correctly engaged with the projections of the drain socket (A) and drain cap (B). Otherwise, water leakage may result.

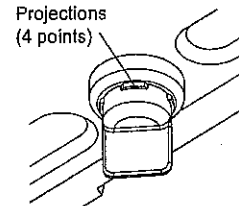
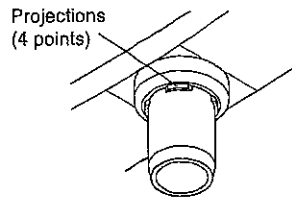

3. Connect vinyl hose on the market (internal diameter of 1 inch) to drain socket (A).
(If the house is too long and hangs down, fix it carefully to prevent the kinks.)
4. Make sure that there is no water leakage from portion I, II, or III.

NOTE

If the drain holes of the outdoor unit are covered with the mounting bracket or the floor, raise the unit to provide the space of more than 3-15/16 inch under the leg of the outdoor unit.

3 Refrigerant Piping

CAUTION

- 1) Use the flare nut fixed to the main unit to prevent cracking and age deterioration.
- 2) To prevent gas leakage, apply refrigeration oil only to the inner surface of the flare. (Use refrigeration oil for R410A.)
- 3) Use torque wrenches when tightening the flare nuts to prevent damage to the flare nuts and gas leakage.

Align the centers of both flares and tighten the flare nuts 3 or 4 turns by hand. Then tighten them fully with the torque wrenches.

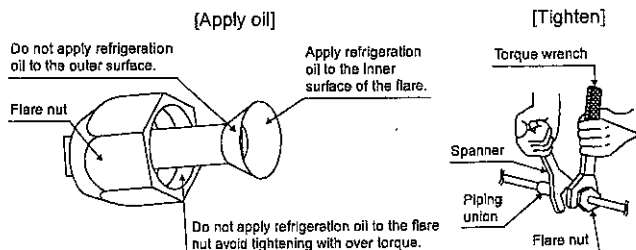

Flare nut tightening torque		Valve cap tightening torque	
Flare nut for $\phi 1/4$	10.5-12.7 ft-lbf	Liquid pipe	19.5-23.8 ft-lbf
Flare nut for $\phi 3/8$	24.1-29.4 ft-lbf		
Flare nut for $\phi 1/2$	36.5-44.5 ft-lbf	Gas pipe	35.5-44.0 ft-lbf
Flare nut for $\phi 5/8$	45.6-55.6 ft-lbf		
Service port cap tightening torque		7.9-10.8 ft-lbf	

Refrigerant Piping Work (2)

4 Purging Air and Checking Gas Leakage

- When piping work is completed, it is necessary to purge the air and check for gas leakage.

⚠ WARNING

- 1) Do not mix any substance other than the specified refrigerant (R410A) into the refrigeration cycle.
- 2) When refrigerant gas leaks occur, ventilate the room as soon and as much as possible.
- 3) R410A, as well as other refrigerants, should always be recovered and never be released directly into the environment.
- 4) Use a vacuum pump for R410A exclusively. Using the same vacuum pump for different refrigerants may damage the vacuum pump or the unit.

- If using additional refrigerant, perform air purging from the refrigerant pipes and indoor unit using a vacuum pump, then charge additional refrigerant.
- Use a hexagonal wrench (3/16") to operate the stop valve rod.
- All refrigerant pipe joints should be tightened with a torque wrench at the specified tightening torque.

1) Connect projection side of charging hose (which comes from gauge manifold) to gas stop valve's service port.



2) Fully open gauge manifold's low-pressure valve (Lo) and completely close its high-pressure valve (Hi).
(High-pressure valve subsequently requires no operation.)



3) Apply vacuum pumping. Check that the compound pressure gauge reads -29.9in Hg.
Evacuation for **at least 1 hour** is recommended.



4) Close gauge manifold's low-pressure valve (Lo) and stop vacuum pump.
(Leave as is for 4-5 minutes and make sure the coupling meter needle does not go back.
If it does go back, this may indicate the presence of moisture or leaking from connecting parts. After inspecting all the connection and loosening then retightening the nuts, repeat steps 2-4.)



5) Remove covers from liquid stop valve and gas stop valve.



6) Turn the liquid stop valve's rod 90 degrees counterclockwise with a hexagonal wrench to open valve.
Close it after 5 seconds, and check for gas leakage.
Using soapy water, check for gas leakage from indoor unit's flare and outdoor unit's flare and valve rods.
After the check is complete, wipe all soapy water off.



7) Disconnect charging hose from gas stop valve's service port, then fully open liquid and gas stop valves.
(Do not attempt to turn valve rod beyond its stop.)



8) Tighten valve caps and service port caps for the liquid and gas stop valves with a torque wrench at the specified torques. See "3 Refrigerant Piping" in "Refrigerant Piping Work (1)" for details.

5 Refilling The Refrigerant

Check the type of refrigerant to be used on the machine nameplate.

Precautions when adding R410A

Fill from the liquid pipe in liquid form.

It is a mixed refrigerant, so adding it in gas form may cause the refrigerant composition to change, preventing normal operation.

- 1) Before filling, check whether the cylinder has a siphon attached or not. (It should have something like "liquid filling siphon attached" displayed on it.)

Filling a cylinder with an attached siphon

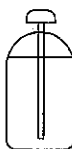

Stand the cylinder upright when filling.

(There is a siphon pipe inside, so the cylinder need not be upside-down to fill with liquid.)

Filling other cylinders



Turn the cylinder upside-down when filling.

- 2) Be sure to use the R410A tools to ensure pressure and to prevent foreign objects entering.

Refrigerant Piping Work (3)

6 Charging with Refrigerant

- If the total length of piping for all rooms exceeds the figure listed below, additionally charge with 0.22oz of refrigerant (R410A) for each additional feet of piping.

Outdoor unit capacity class	3MXS24*, 4MXS32*
Total length of piping for all rooms	131.2ft

CAUTION

Even though the stop valve is fully closed, the refrigerant may slowly leak out; do not leave the flare nut removed for a long period of time.

7 Refrigerant Piping Work

Cautions on Pipe Handling

- 1) Protect the open end of the pipe against dust and moisture.
- 2) All pipe bends should be as gentle as possible. Use a pipe bender for bending.

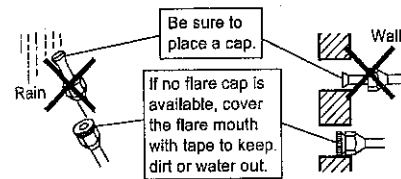

Selection of copper and heat insulation materials

When using commercial copper pipes and fittings, observe the following:

- 1) Insulation material: Polyethylene foam
Heat transfer rate: 0.041 to 0.052W/mK (0.024 to 0.030 Btu/ft²°F)
Refrigerant gas pipe's surface temperature reaches 230°F max.
Choose heat insulation materials that will withstand this temperature.
- 2) Be sure to insulate both the gas and liquid piping and to provide insulation dimensions as below.

Gas pipe	O.D.: 3/8", 1/2" / Thickness:0.031" (C1220T-O) O.D.: 5/8" / Thickness:0.039" (C1220T-O)
Liquid pipe	O.D.: 1/4" / Thickness:0.031" (C1220T-O)
Gas pipe insulation	I.D.: 0.472-0.590" / Thickness:0.511" min. I.D.: 0.630-0.787" / Thickness:0.511" min.
Liquid pipe insulation	I.D.: 0.315-0.393" / Thickness:0.393" min.
Minimum bend radius	O.D.: 3/8", 1/4" / 1-3/16" or more O.D.: 1/2" / 1-9/16" or more O.D.: 5/8" / 1-15/16" or more

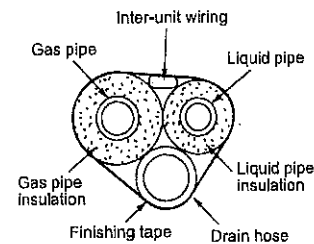

- 3) Use separate thermal insulation pipes for gas and liquid refrigerant pipes.

8 Flaring the Pipe End

- 1) Cut the pipe end with a pipe cutter.
- 2) Remove burrs with the cut surface facing downward so that the chips do not enter the pipe.
- 3) Put the flare nut on the pipe.
- 4) Flare the pipe.
- 5) Check that the flaring is properly made.

Flaring

Set exactly at the position shown below.

Flare tool for R410A	Conventional flare tool		
	Clutch-type	Clutch-type (Rigid-type)	Wing-nut type (Imperial-type)
A	0-0.020"	0.039-0.059"	0.059-0.079"

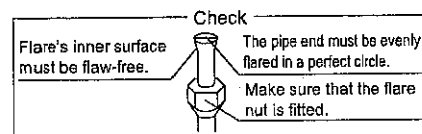

WARNING

- 1) Do not use mineral oil on flared part.
- 2) Prevent mineral oil from getting into the system as this would reduce the lifetime of the units.
- 3) Never use piping which has been used for previous installations. Only use parts which are delivered with the unit.
- 4) Never install a drier to this R410A unit in order to guarantee its lifetime.
- 5) The drying material may dissolve and damage the system.
- 6) Incomplete flaring may cause refrigerant gas leakage.

How to Use Reducers

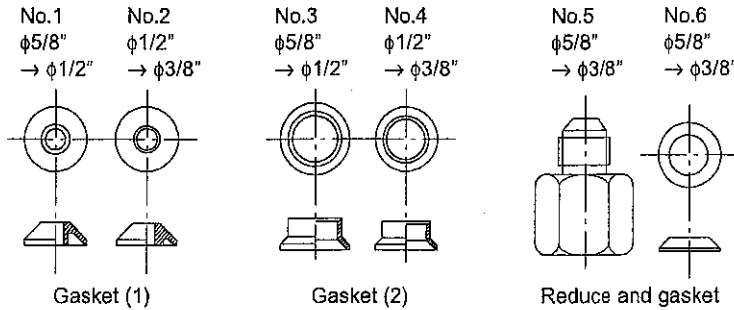

Use the reducers supplied with the unit as described below.

(1) Connecting a pipe of $\phi 1/2"$ to a gas pipe connection port for $\phi 5/8"$:

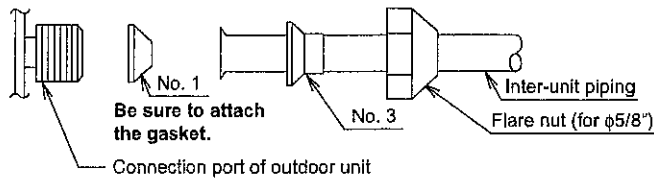

(2) Connecting a pipe of $\phi 3/8"$ to a gas pipe connection port for $\phi 5/8"$:

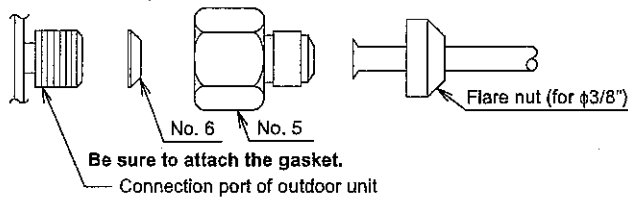

(3) Connecting a pipe of $\phi 3/8"$ to a gas pipe connection port for $\phi 1/2"$:

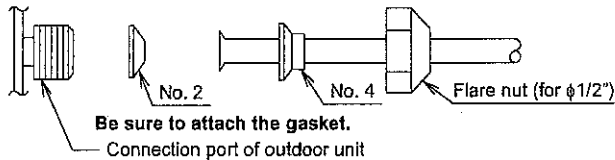

- When using the reducer packing shown above, be careful not to overtighten the nut, or the smaller pipe may be damaged. (about 2/3-1 the normal torque)
- Apply a coat of refrigeration oil to the threaded connection port of the outdoor unit where the flare nut comes in.
- Use an appropriate wrench to avoid damaging the connection thread by overtightening the flare nut.

Flare nut tightening torque	
Flare nut for $\phi 3/8"$	24.1-29.4 ft-lbf
Flare nut for $\phi 1/2"$	36.5-44.5 ft-lbf
Flare nut for $\phi 5/8"$	45.6-55.6 ft-lbf

Pump Down Operation

In order to protect the environment, be sure to pump down when relocating or disposing of the unit.

- 1) Remove the valve cap from liquid stop valve and gas stop valve.
- 2) Carry out forced cooling operation. See "Forced Operation".
- 3) After five to ten minutes, close the liquid stop valve with a hexagonal wrench.
- 4) After two to three minutes, close the gas stop valve and stop forced cooling operation.

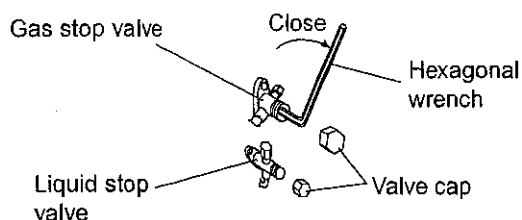

Forced Operation

- 1) Turn the Operation Mode switch (SW2) to "COOL."
- 2) Press the Forced Operation switch (SW1) to begin forced cooling. Press the Forced Operation switch (SW1) again to stop forced cooling.
 - Forced operation also stops automatically after 15 minutes from when operation starts.

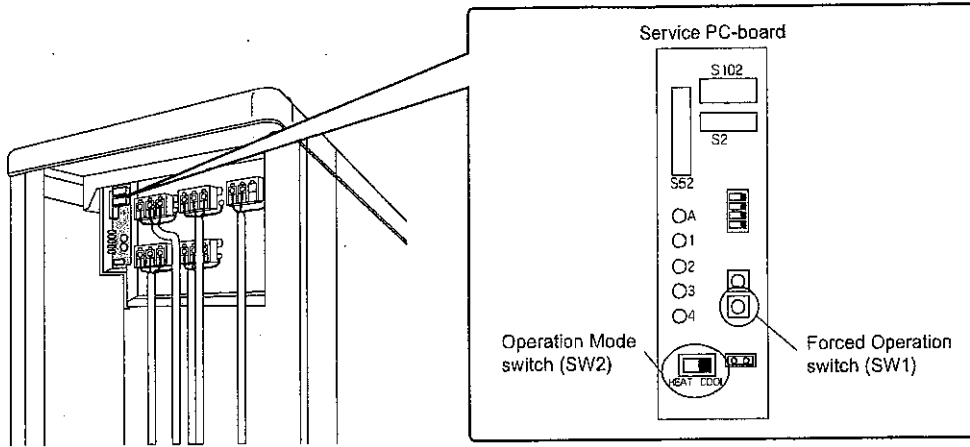

Wiring (1)

⚠ WARNING

- 1) Do not use spliced wires, stranded wires (**CAUTION (1)**), extension cords, or starburst connections, as they may cause overheating, electrical shock, or fire. Follow all local, and state electrical codes.
- 2) Do not use locally purchased electrical parts inside the product. (Do not branch the power for the drain pump, etc., from the terminal block.) Doing so may cause electric shock or fire.
- 3) Be sure to install a ground leak detector. (One that can handle higher harmonics.)
(This unit uses an inverter, which means that it must be used a ground leak detector capable handling harmonics in order to prevent malfunctioning of the ground leak detector itself.)
- 4) Use an all-pole disconnection type breaker with at least 1/8" between the contact point gaps.
- 5) When carrying out wiring connection, take care not to pull at the conduit.
- 6) Do not connect the power wire to the indoor unit. Doing so may cause electric shock or fire.

<Method of Mounting Conduit>

- 1) Pass wires through the conduit and secure them with a lock nut.
- 2) When connecting indoor units for three rooms or more, open knockout holes without deforming the conduit mounting plate.
By removing the two screws to remove the conduit mounting plate, you can work without the plate. After completing the work, reattach the conduit mounting plate to its original position.

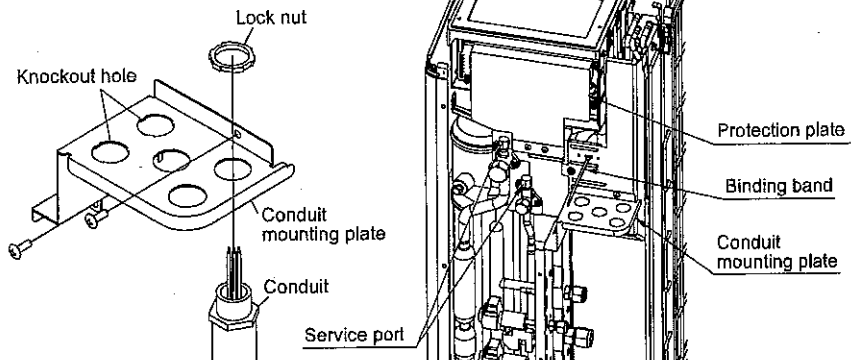

<Work before wiring>

A protection plate is fixed for protection from the high-voltage section.

Before starting wiring work, remove the two screws and the protection plate.

After completing wiring, fix the protection plate to its original position.

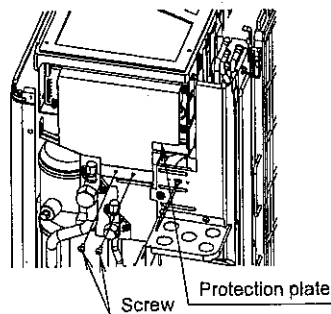

⚠ WARNING

- 1) When the protection plate is removed, do not turn ON the safety breaker.
- 2) When the service port is operated, the protection plate must be fixed.

Wiring (2)

- Do not turn ON the safety breaker until all work is completed.

<Wiring procedure>

- Strip the insulation from the wire (3/4").
- Connect the connection wires between the indoor and outdoor units **so that the terminal numbers match**. Tighten the terminal screws securely. We recommend a flathead screwdriver be used to tighten the screws. The screws are packed with the terminal board.
- Be sure to match the symbols for wiring and piping.**
- Pull the wire and make sure that it does not disconnect. Then fix the wire in place with the binding band.

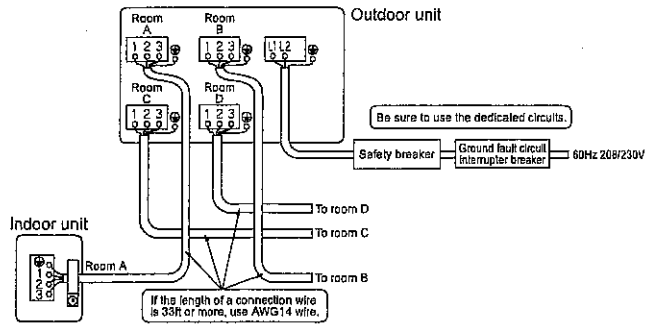

Use AWG 16 or AWG 14 wire for the power supply and interconnecting wires.

⚠ CAUTION (1)

In case using stranded wires is unavoidable, make sure to install the round crimp-style terminals on the tip.

Place the round crimp-style terminals on the wires up to the covered part and secure in place.

Round crimp-style terminal



Stranded wire

<Ground terminal installation>

- Use the following method when installing a single core wire.

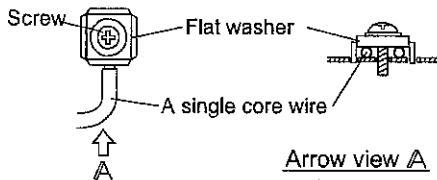

Arrow view A

- Use the following method when installing the round crimp-style terminal.

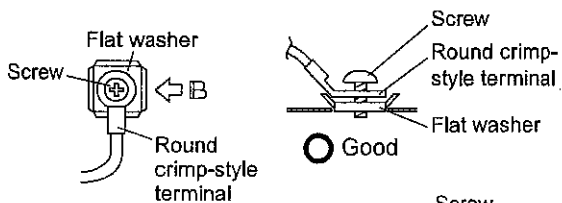

Good

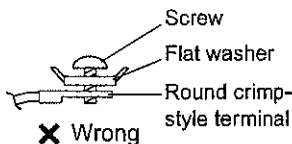

Wrong

Arrow view B

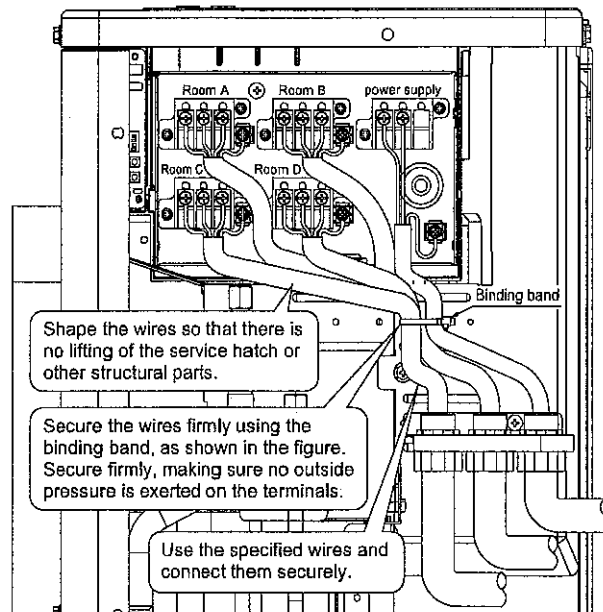

⚠ CAUTION (2)

When connecting the connection wires to the terminal board using a single core wire, be sure to perform curling. Problems with the work may cause heat and fires.

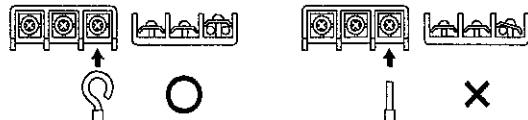

Ground

This air conditioner must be grounded. For grounding, follow all local, and state electrical codes.

Priority Room Setting

- To use Priority Room Setting, initial settings must be made when the unit is installed. Explain the Priority Room Setting, as described below, to the customer, and confirm whether or not the customer wants to use Priority Room Setting. Setting it in the guest and living rooms is convenient.

About the Priority Room Setting function

The indoor unit for which Priority Room Setting is applied takes priority in the following cases.

1) Operation mode priority

The operation mode of the indoor unit which is set for Priority Room Setting takes priority. If the set indoor unit is operating, all other indoor units do not operate and enter standby mode, according to the operation mode of the set indoor unit.

2) Priority during powerful operation

If the indoor unit which is set for Priority Room Setting is operating at powerful, the capabilities of other indoor units will be somewhat reduced. Power supply gives priority to the indoor unit which is set for Priority Room Setting.

3) Quiet operation priority

Setting the indoor unit to quiet operation will make the outdoor unit run quietly.

Service PC-board

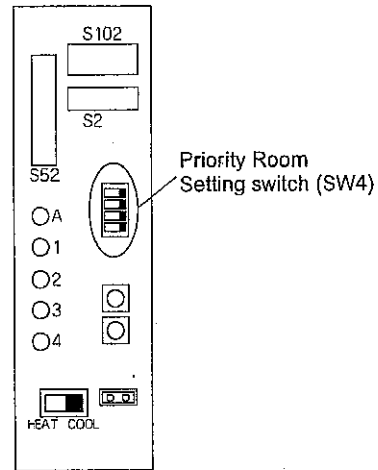

Setting procedure

Slide the switch to the ON side for the switch that corresponds to the piping connected to the indoor unit to be set. (In the figure below, it is room A.)
Once the settings are complete, reset the power.

Be sure to only set one room

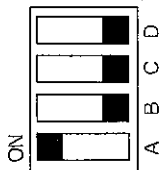

Night Quiet Mode setting

- If Night Quiet Mode is to be used, initial settings must be made when the unit is installed.
Explain Night Quiet Mode, as described below, to the customer, and confirm whether or not the customer wants to use Night Quiet Mode.

About Night Quiet Mode

The Night Quiet Mode function reduces operating noise of the outdoor unit at nighttime. This function is useful if the customer is worried about the effects of the operating noise on the neighbors. However, if Night Quiet Mode is running, cooling capacity will be saved.

Setting procedure

Remove the SW5 jumper switch.
Once the settings are complete, reset the power.

NOTE

Install the removed jumper switch as described below. This switch will be needed to later disable this setting.

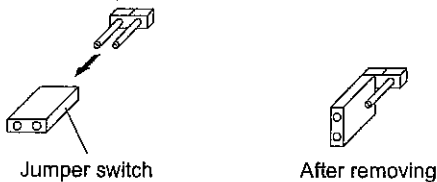

Service PC-board

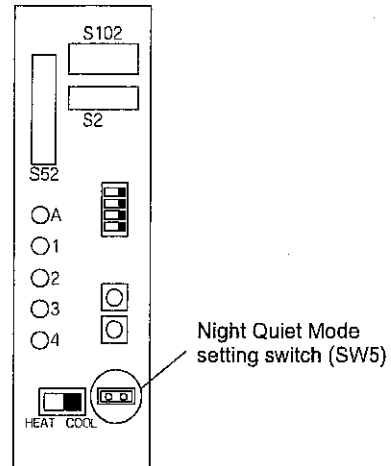

COOL/ HEAT mode lock <S15>

- Use the S15 connector to set the unit to only cool or heat.
Setting to only heat (H): short-circuit pins 1 and 3 of the connector <S15>
Setting to only cool (C): short-circuit pins 3 and 5 of the connector <S15>
The following specifications apply to the connector housing and pins.
JST products Housing: VHR-5N Pin: SVH-21T-1,1
Note that forced operation is also possible in COOL/HEAT mode.

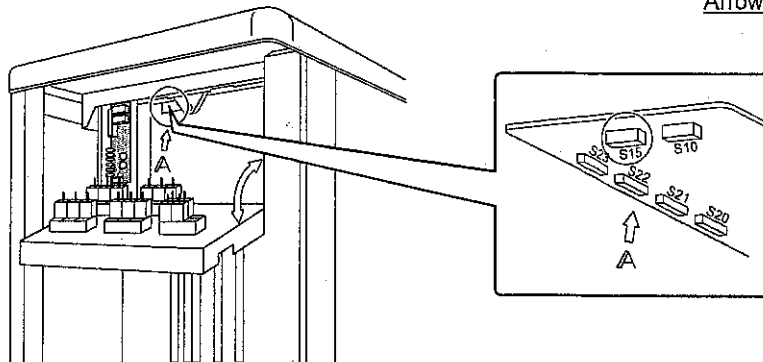
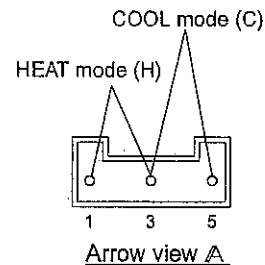

Test Run and Final Check (1)

- Before starting the test run, measure the voltage at the primary side of the safety breaker.
- Check that all liquid and gas stop valves are fully open.
- Check that piping and wiring all match. The wiring error check can be conveniently used for underground wiring and other wiring that cannot be directly checked.

Wiring Error Check

- This product is capable of automatic correction of wiring error.

Press the "wiring error check switch" on the outdoor unit service PC-board. However, the wiring error check switch will not function for 3 minutes after the safety breaker is turned on, or depending on the outside air conditions (See Note 2.). Approximately 15-20 minutes after the switch is pressed, the errors in the connection wiring will be corrected.

The service monitor LEDs indicate whether or not correction is possible, as shown in the table below. For details about how to read the LED display, refer to the service manual.

If self-correction is not possible, check the indoor unit wiring and piping in the usual manner.

Service PC-board

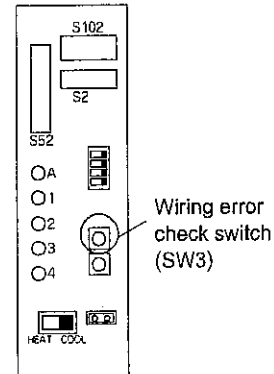

LED	1	2	3	4	Message
Status	All Flashing				Automatic correction impossible
	Flashing		One after another		Automatic correction completed
	☀ (One or more of LEDs 1 to 4 are ON)				Abnormal stop [Note. 4]

Wiring correct example

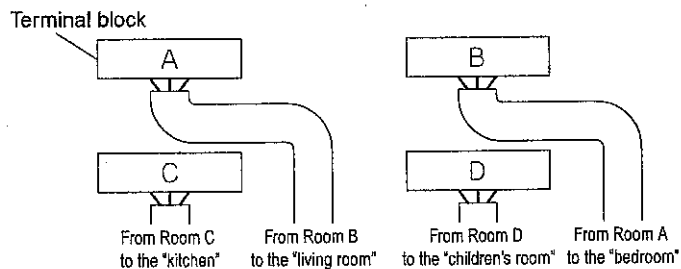

* The figure at left shows branch wiring.

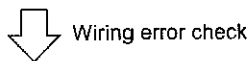

LED lighting sequence after a wiring correction.

Order of LED flashing: 2 → 1 → 3 → 4

NOTE

- 1) For two rooms, LED 3 and 4 are not displayed, and for three rooms, LED 4 is not displayed.
- 2) If the outside air temperature is 41°F or less, the wiring error check function will not operate.
- 3) After wiring error check operation is completed, LED indication will continue until ordinary operation starts. This is normal.
- 4) Follow the product diagnosis procedures. (Details of product error diagnosis are listed on the back of the right side plate.)

Test Run and Final Check (2)

Test Run and Final Check

- To test cooling, set for the lowest temperature. To test heating, set for the highest temperature. (Depending on the room temperature, only heating or cooling (but not both) may be possible.)
- After the unit is stopped, it will not start again (heating or cooling) for approximately 3 minutes.
- During the test run, first check the operation of each unit individually. Then also check the simultaneous operation of all indoor units.
Check both heating and cooling operation.
- After running the unit for approximately 20 minutes, measure the temperatures at the indoor unit inlet and outlet. If the measurements are above the values shown in the table below, then they are normal.

	Cooling	Heating
Temperature difference between inlet and outlet	Approx. 14°F	Approx. 36°F

(When running in one room)

- During cooling operation, frost may form on the gas stop valve or other parts. This is normal.
- Operate the indoor units in accordance with the included operation manual. Check that they operate normally.

Items to Check

Check item	Consequences of trouble	Check
Are the indoor units installed securely?	Falling, vibration, noise	
Has an inspection been made to check for gas leakage?	No cooling, no heating	
Has complete thermal insulation been done (gas pipes, liquid pipes, indoor portions of the drain hose extension)?	Water leakage	
Is the drainage secure?	Water leakage	
Are the ground wire connections secure?	Danger in the event of a ground fault	
Are the electric wires connected correctly?	No cooling, no heating	
Is the wiring in accordance with the specifications?	Operation failure, burning	
Are the inlets/outlets of the indoor and outdoor units free of any obstructions? Are the stop valves open?	No cooling, no heating	
Do the marks match (room A, room B, room C, room D) on the wiring and piping for each indoor unit?	No cooling, no heating	
Is the priority room setting set for 2 or more rooms?	The priority room setting will not function.	

ATTENTION

- Have the customer actually operate the unit while looking at the manual included with the indoor unit. Instruct the customer how to operate the unit correctly (particularly cleaning of the air filters, operation procedures, and temperature adjustment).
- Even when the air conditioner is not operating, it consumes some electric power. If the customer is not going to use the unit soon after it is installed, turn OFF the breaker to avoid wasting electricity.
- If additional refrigerant has been charged because of long piping, list the amount added on the nameplate on the reverse side of the stop valve cover.

WBB300 & WBB300SS

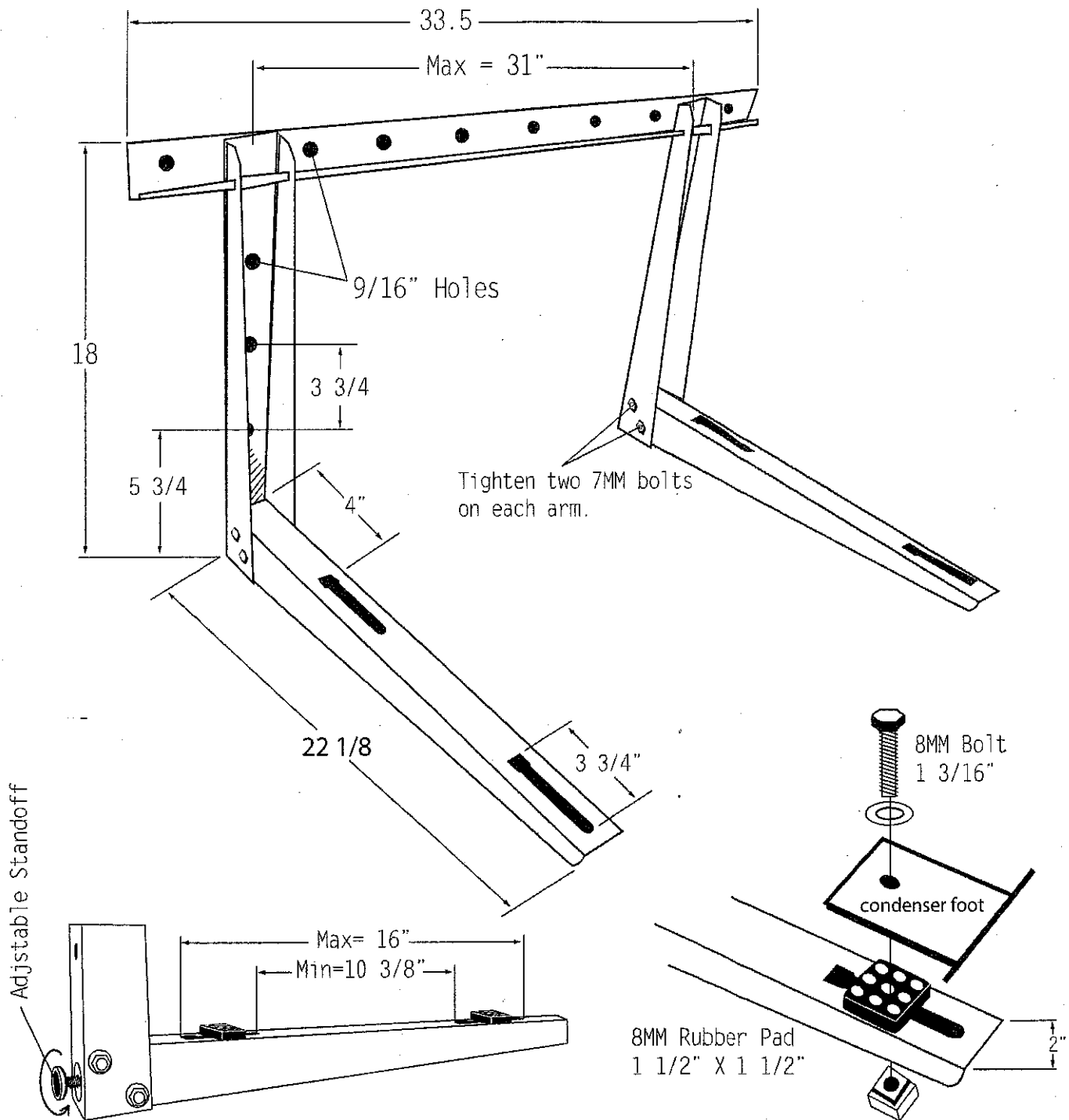

AIRTEC

1244 Davol Street, Fall River MA 02720
Tel: 508-675-2669 Fax: 508-673-0115

Part Name:

WBB300 Wall Condenser Bracket 300 LB. WBB300SS Wall Condenser Bracket 300 LB. Stainless

Crossbar and Arms 2MM Steel

Total Weight: 11 LBS

Capacity LBS: 300

