

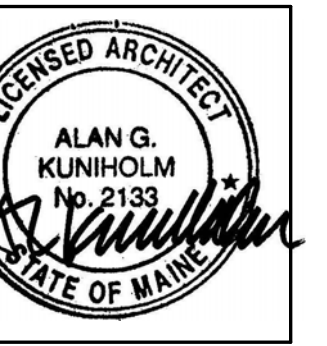

49 DARTMOUTH STREET  
PORTLAND, MAINE 04101  
207-775-1059  
www.pdtarch.com

COPYRIGHT 2012  
PDT Architects  
Reuse or reproduction of the  
contents of this document is not  
permitted without written  
permission of PDT Architects.

ADAMS SCHOOL REDEVELOPMENT  
Portland, Maine



JOB NO.  
08-056

DRWN. CHK  
Checker

SCALE:  
As indicated

ISSUE  
5 MARCH 2012

TITLE  
DOOR & WINDOW  
DETAILS

SHEET

A505

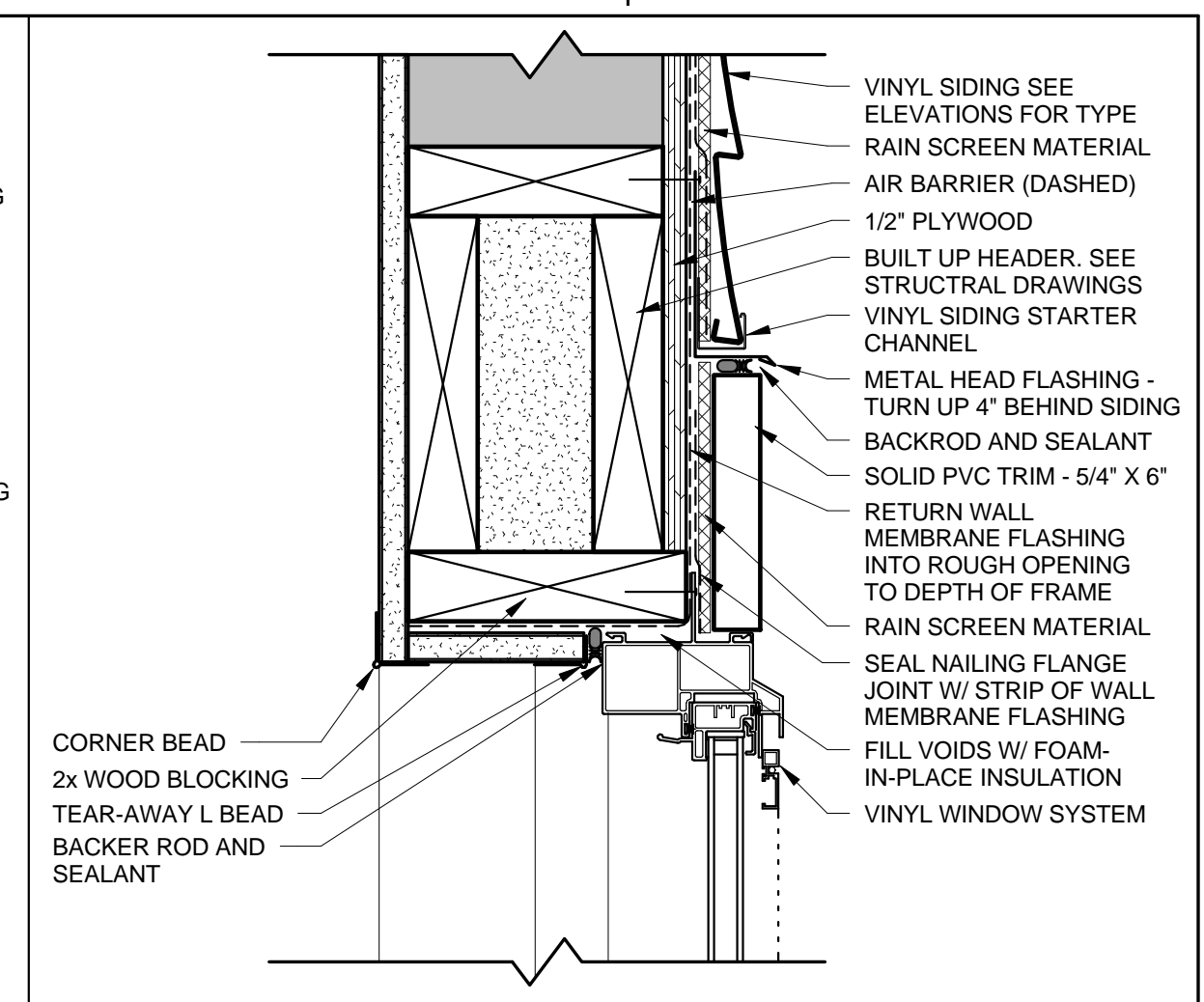

D1 WINDOW HEAD DETAIL  
3" = 1'-0"

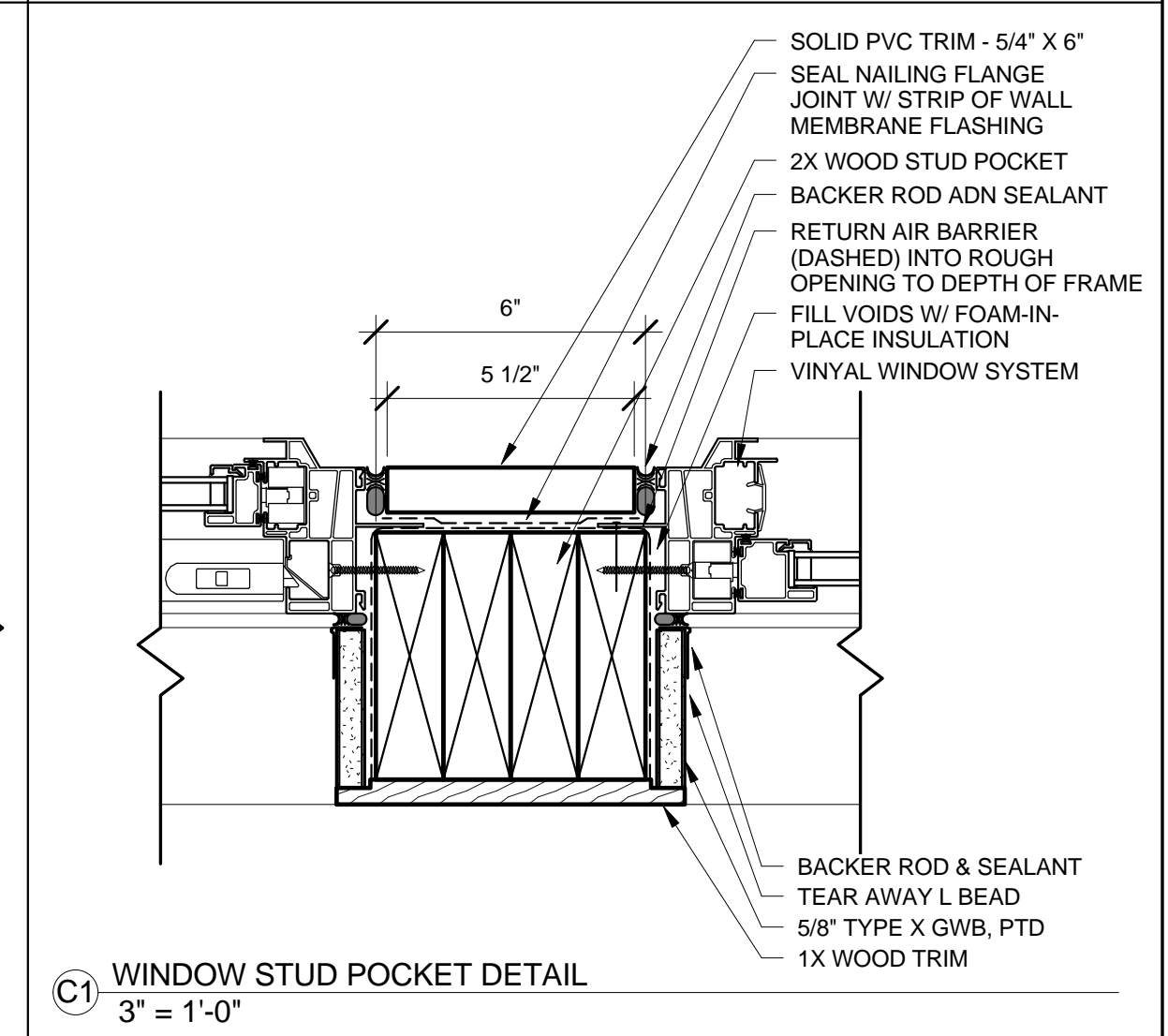

C1 WINDOW STUD POCKET DETAIL  
3" = 1'-0"

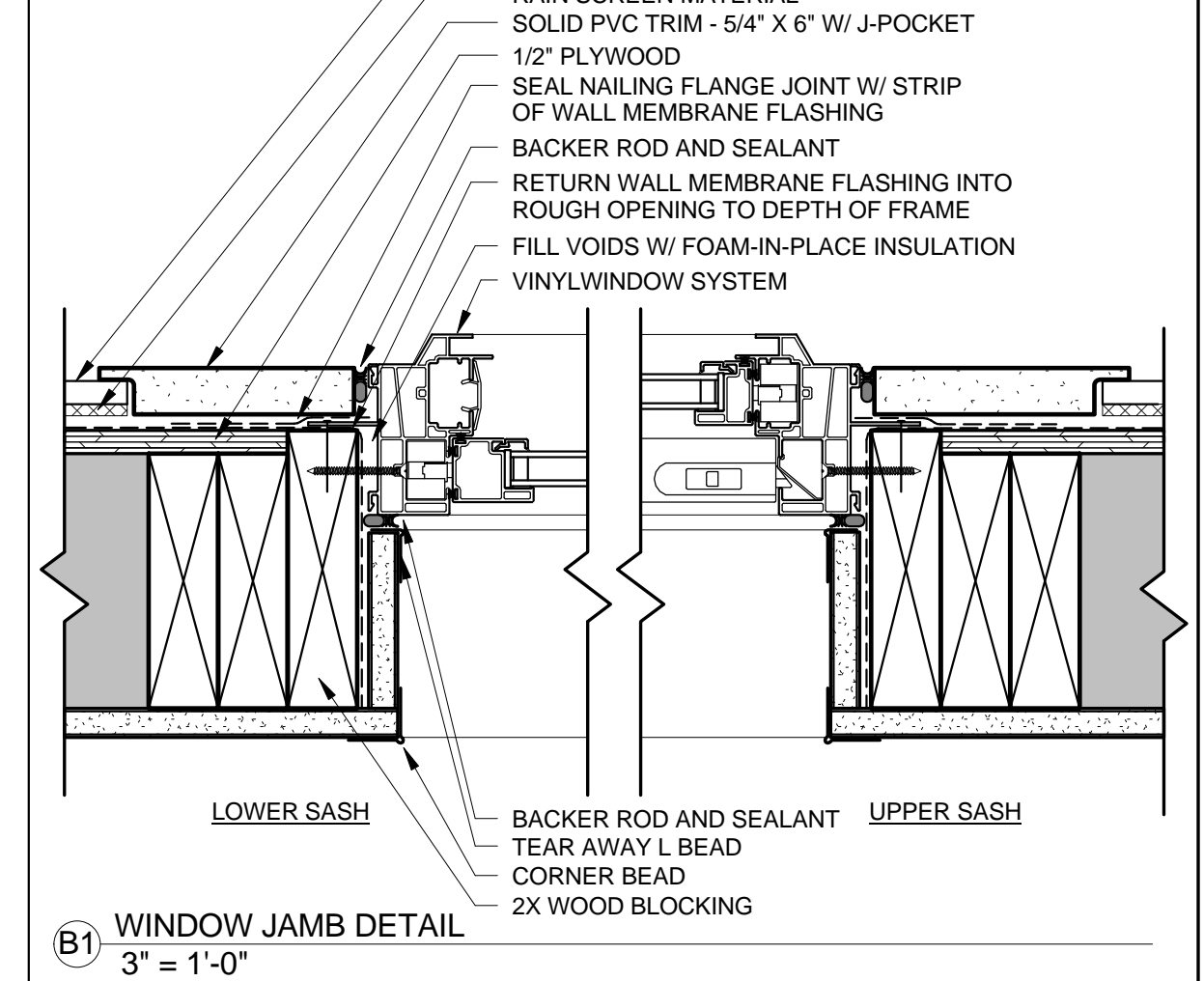

B1 WINDOW JAMB DETAIL  
3" = 1'-0"

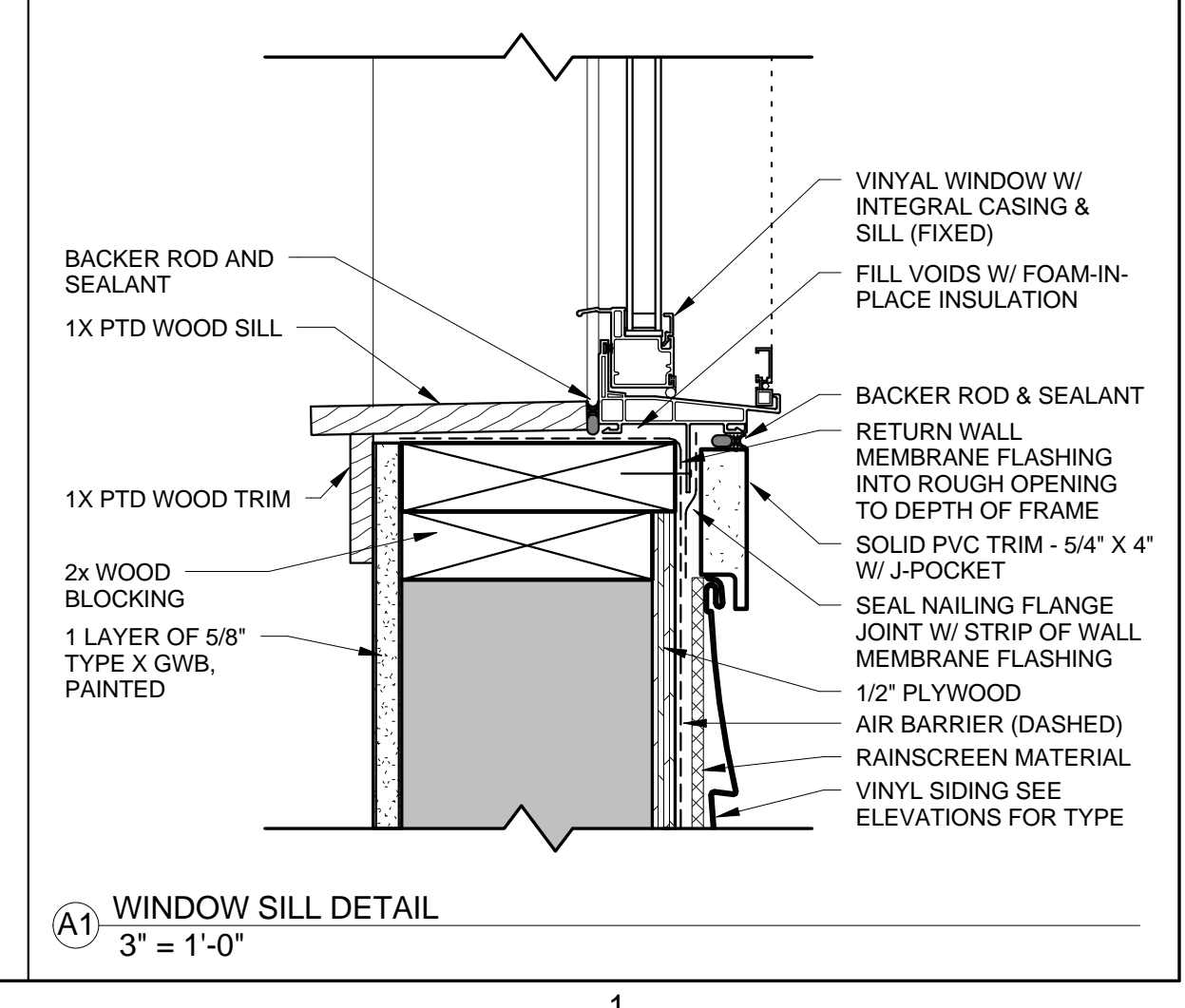

A1 WINDOW SILL DETAIL  
3" = 1'-0"

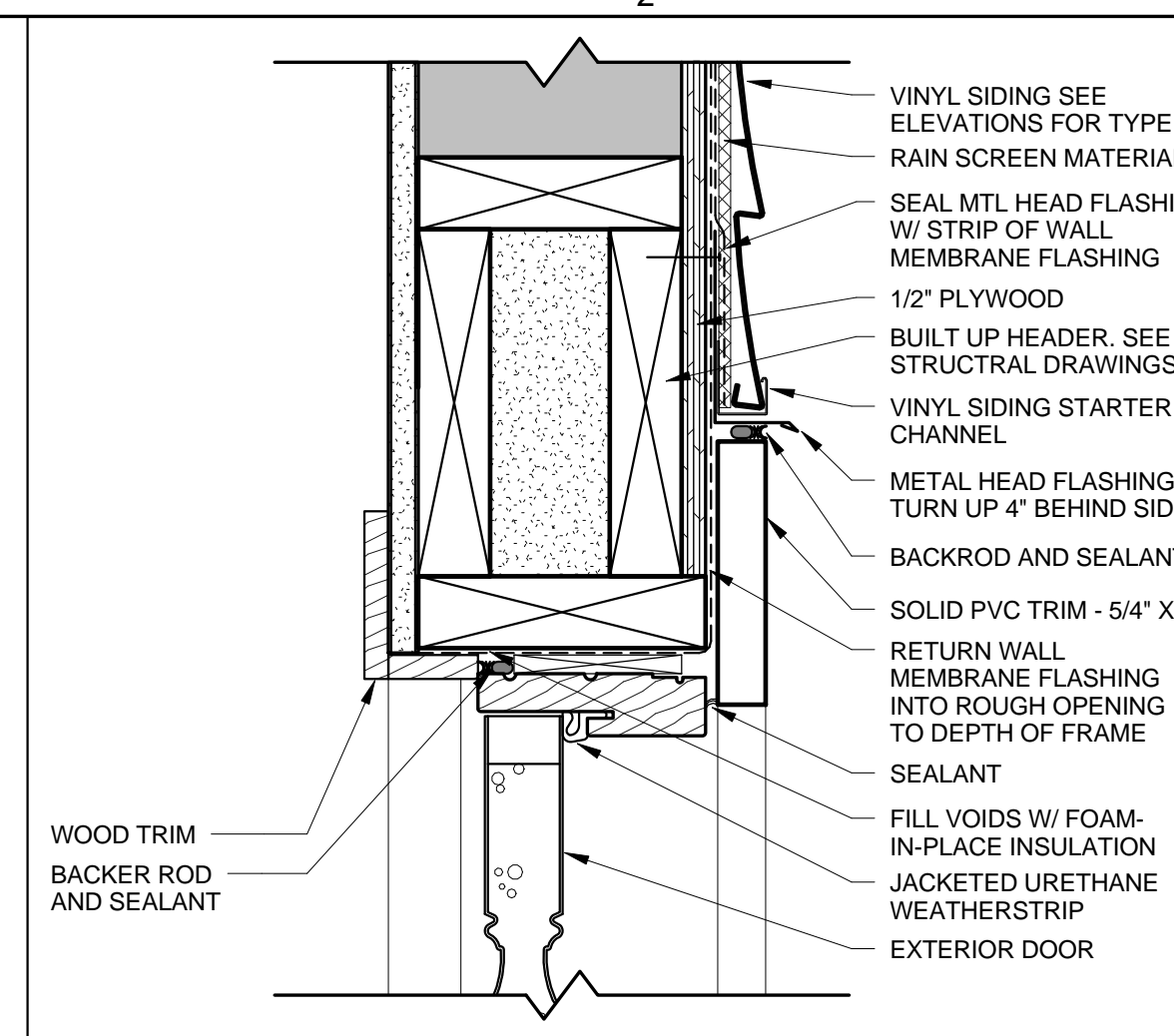

D2 EXTERIOR DOOR HEAD DETAIL  
3" = 1'-0"

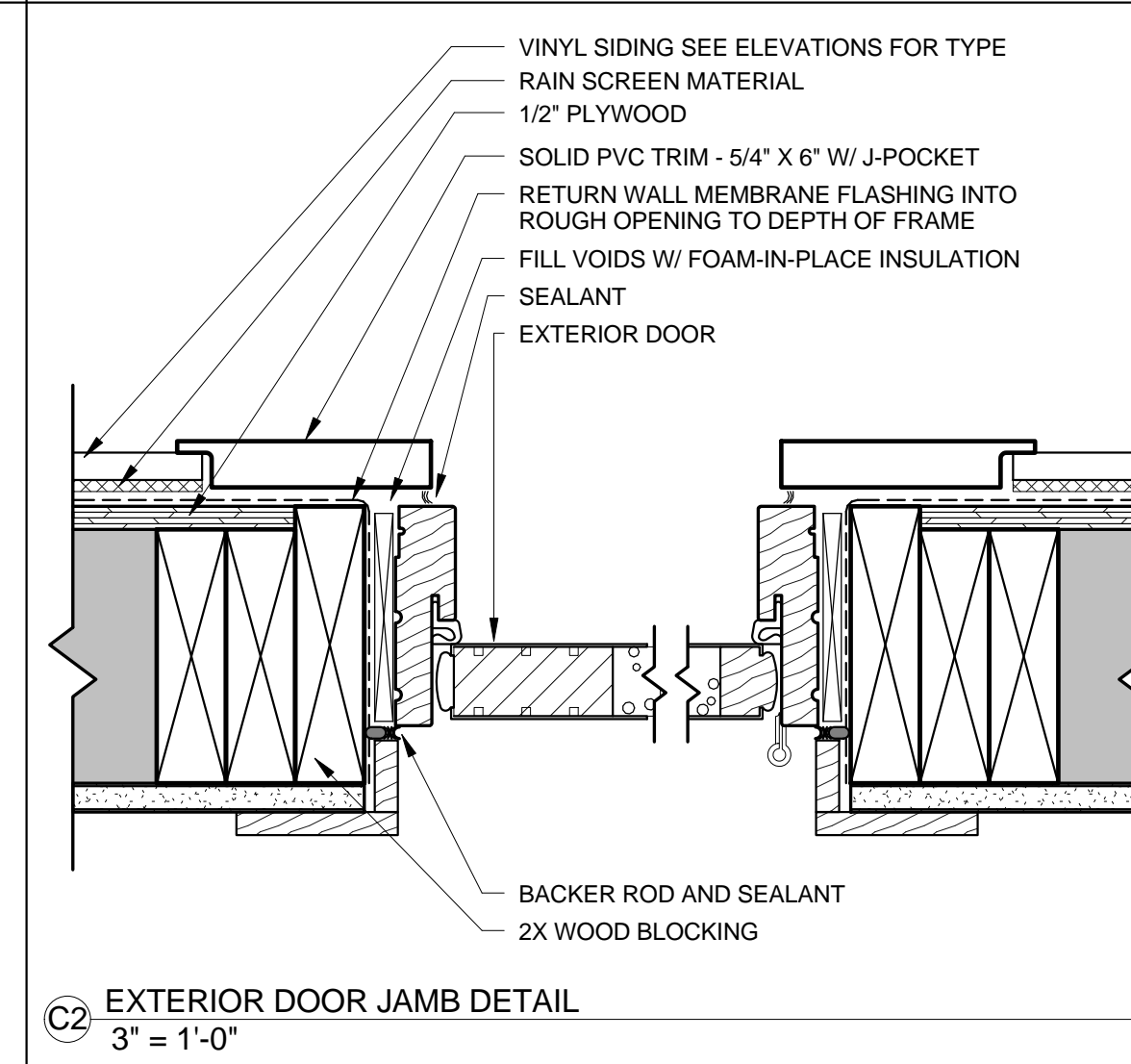

C2 EXTERIOR DOOR JAMB DETAIL  
3" = 1'-0"

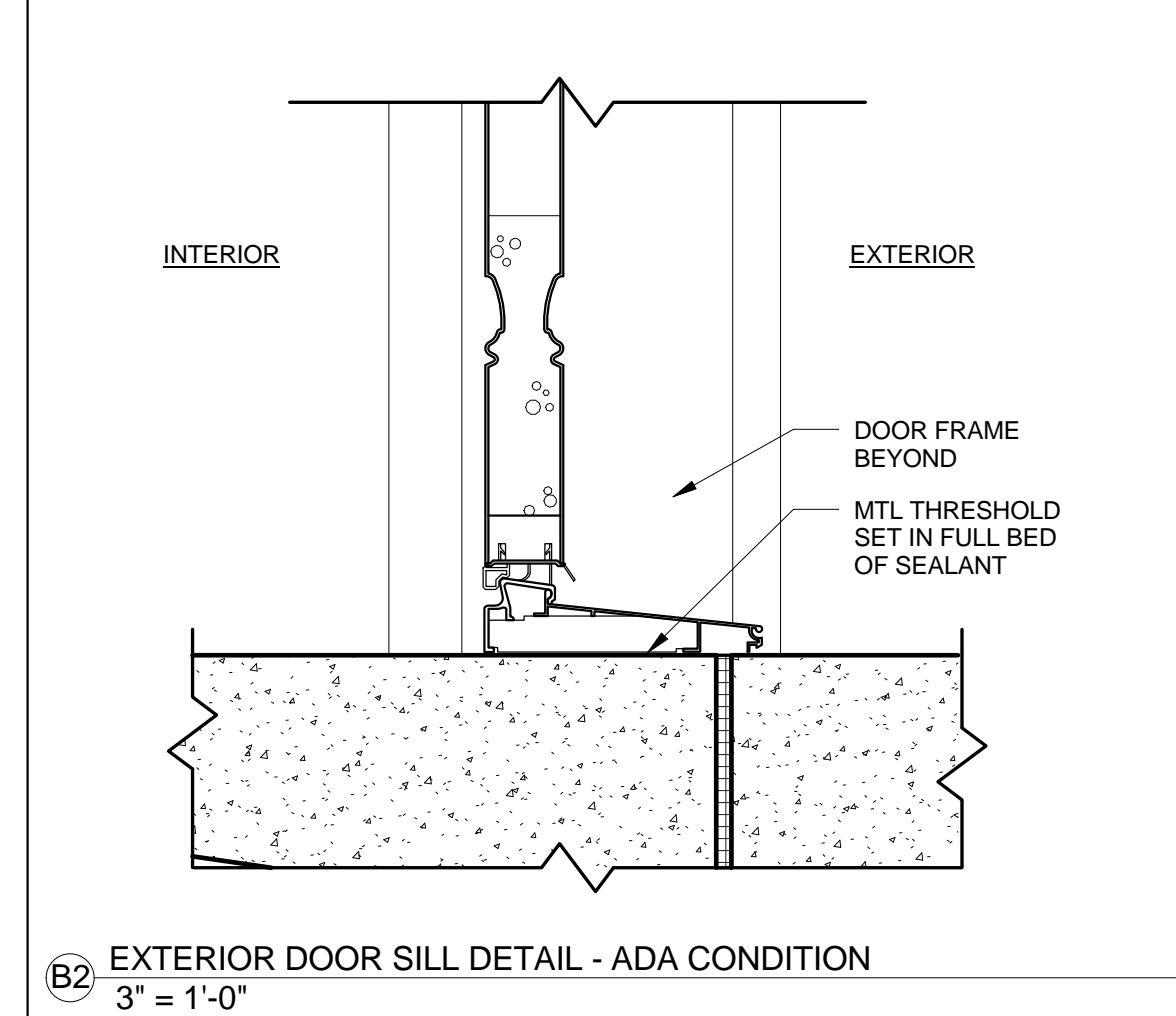

B2 EXTERIOR DOOR SILL DETAIL - ADA CONDITION  
3" = 1'-0"

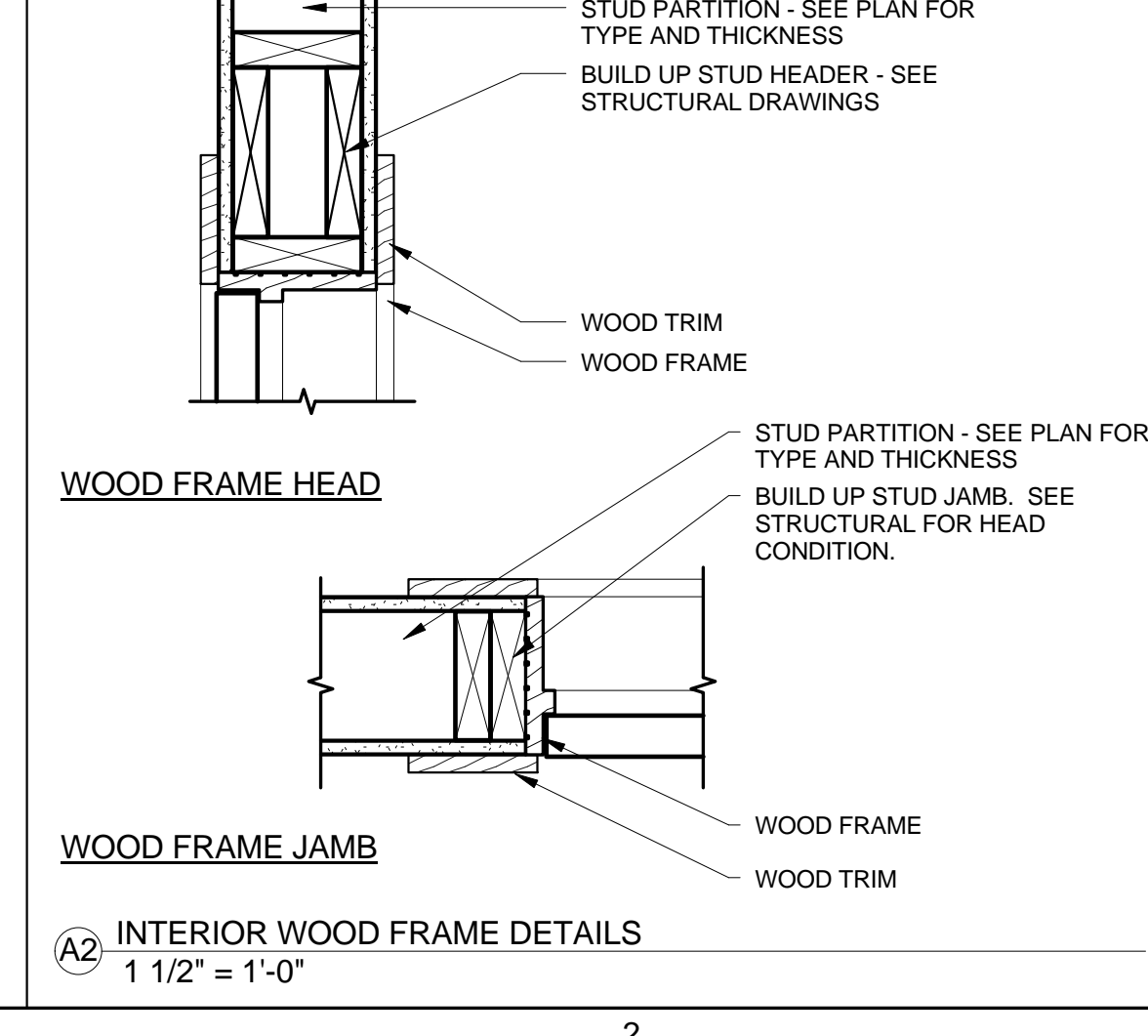

A2 INTERIOR WOOD FRAME DETAILS  
1 1/2" = 1'-0"

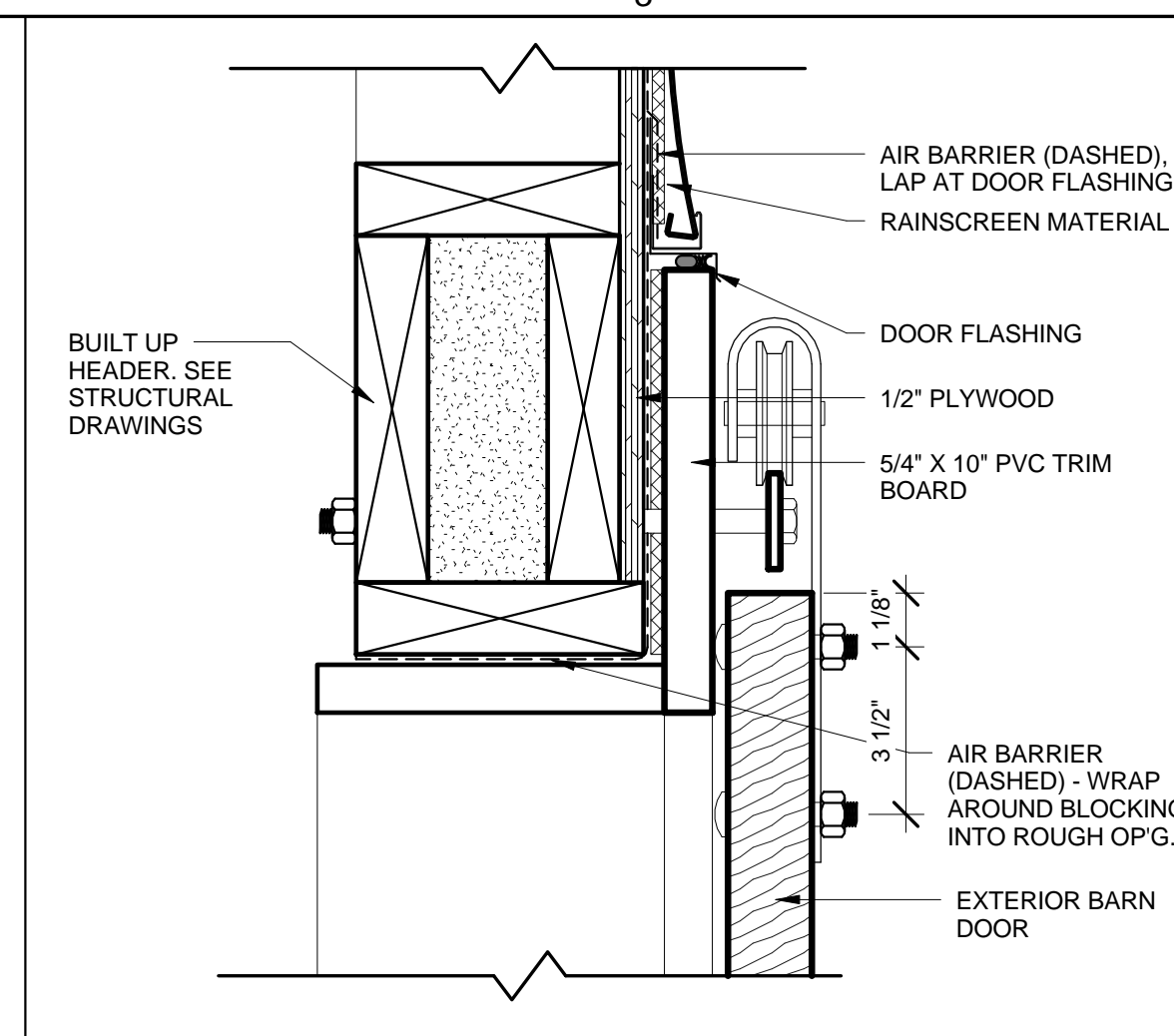

D3 BARN DOOR HEAD DETAIL  
3" = 1'-0"

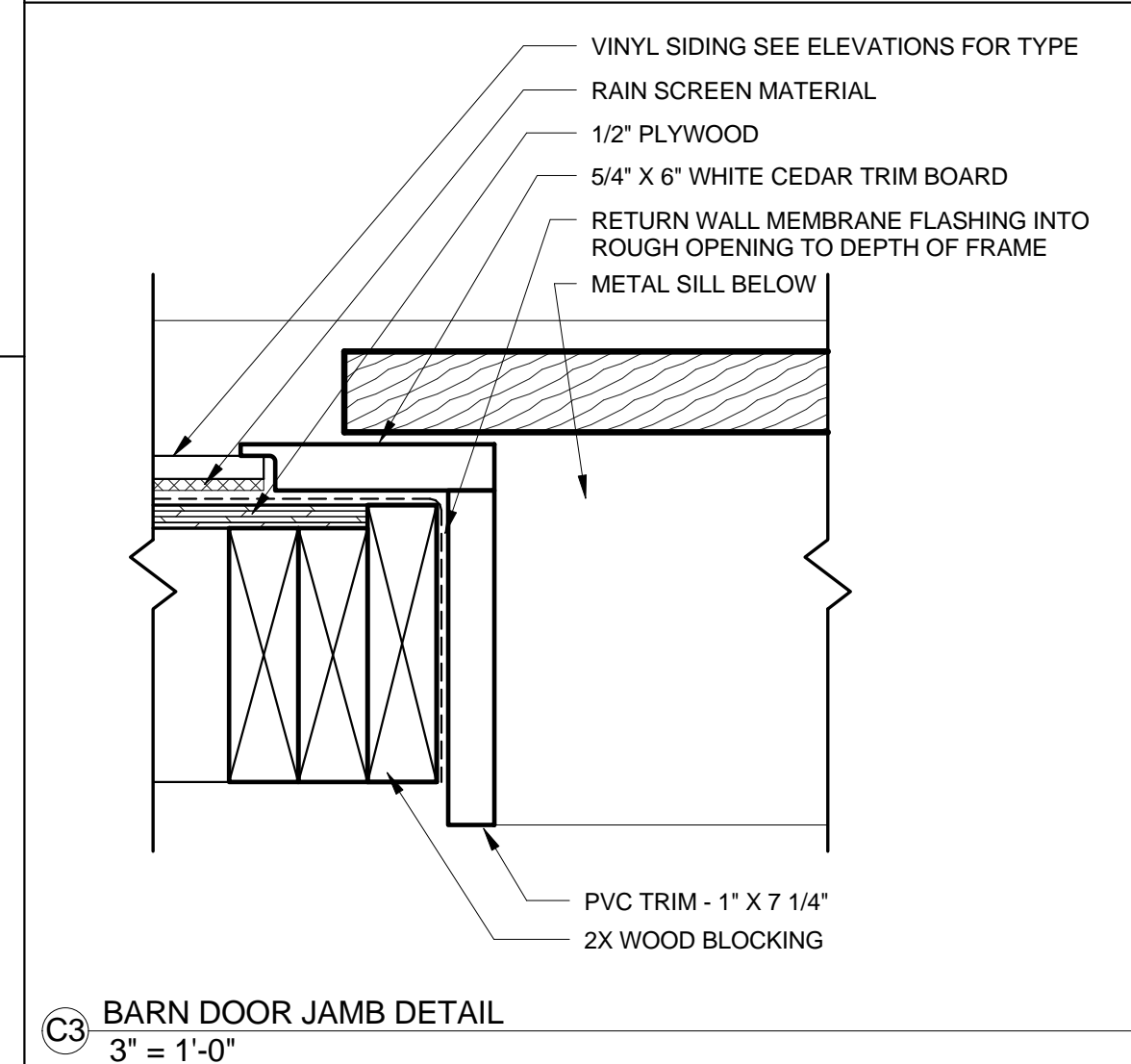

C3 BARN DOOR JAMB DETAIL  
3" = 1'-0"

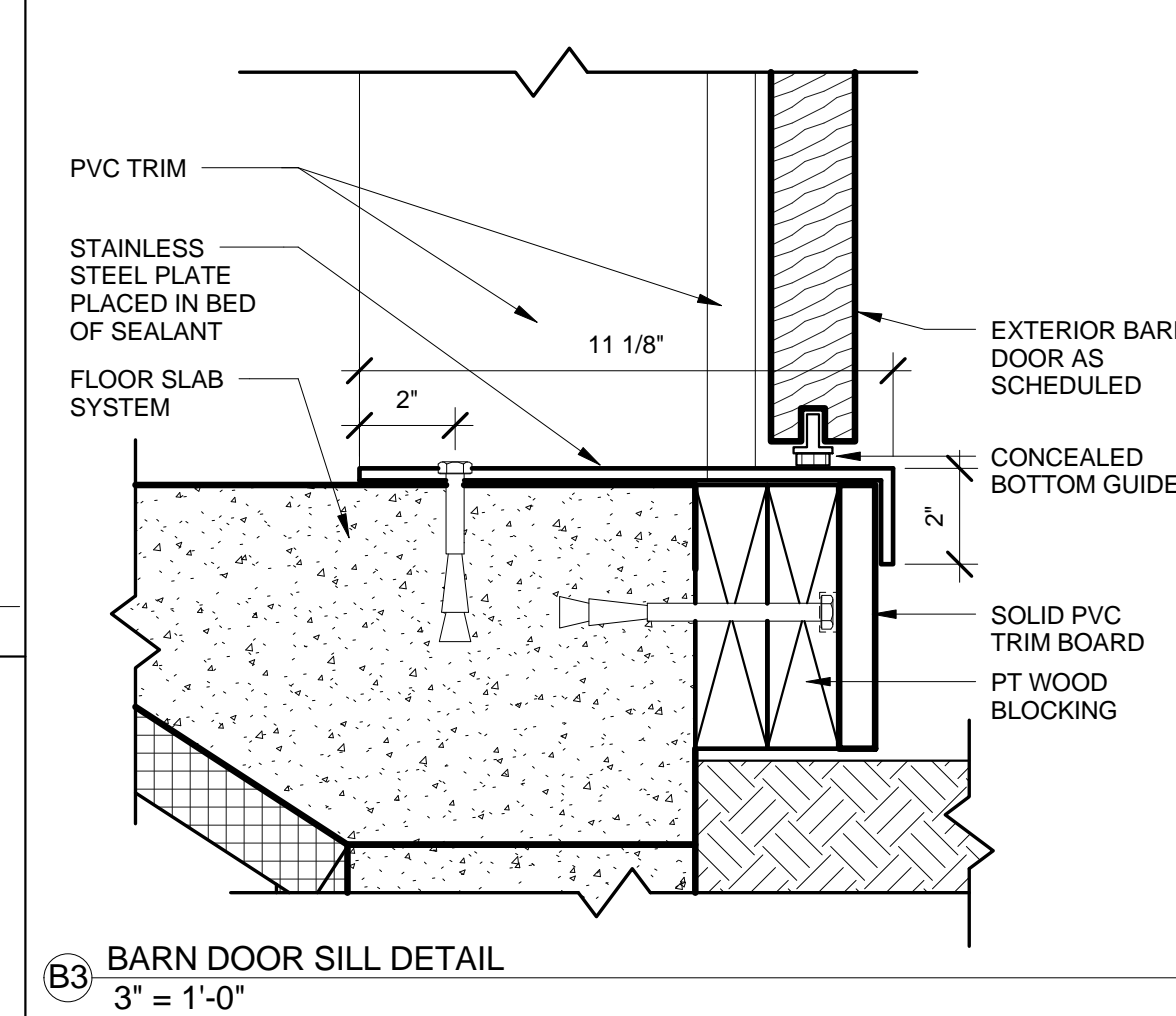

B3 BARN DOOR SILL DETAIL  
3" = 1'-0"

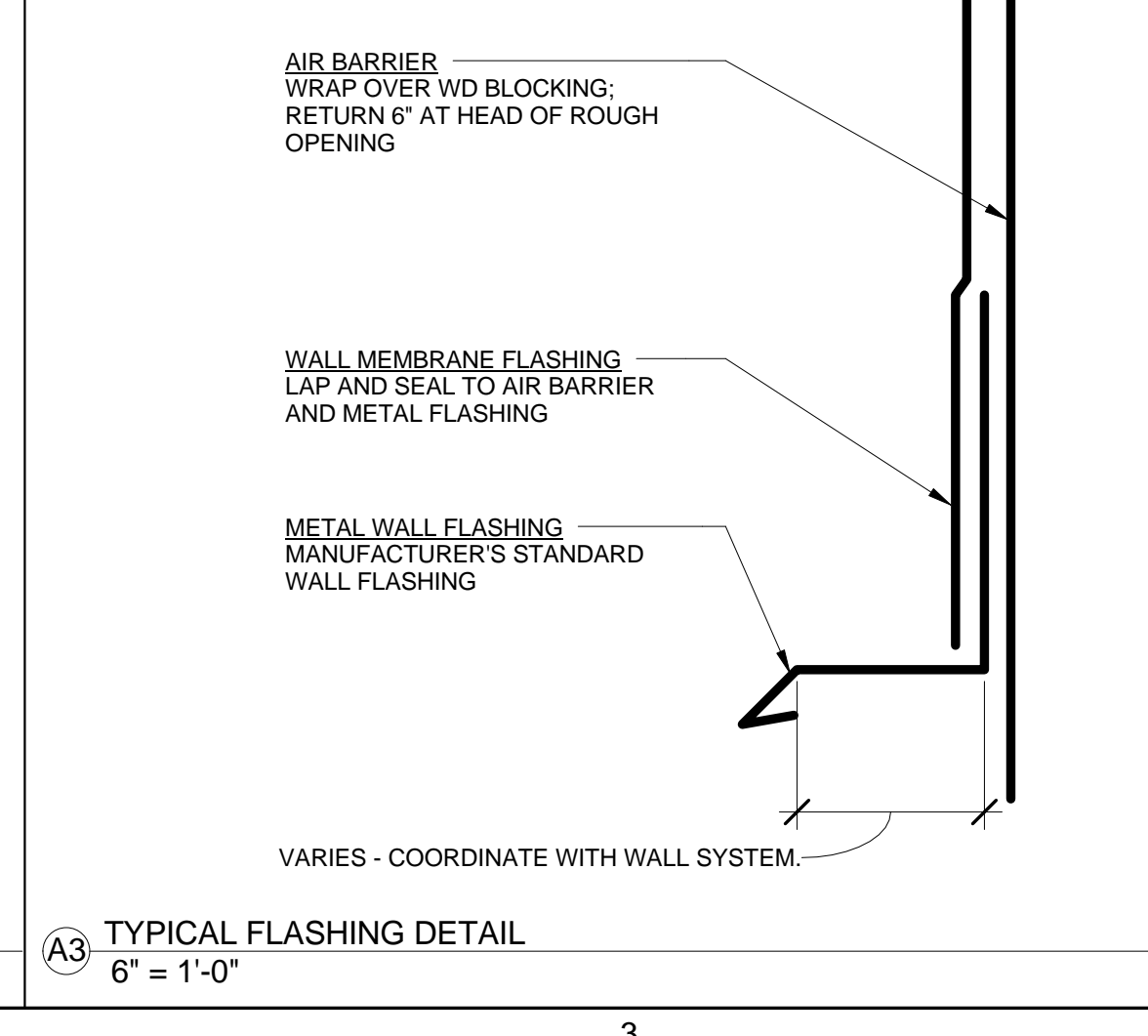

A3 TYPICAL FLASHING DETAIL  
6" = 1'-0"

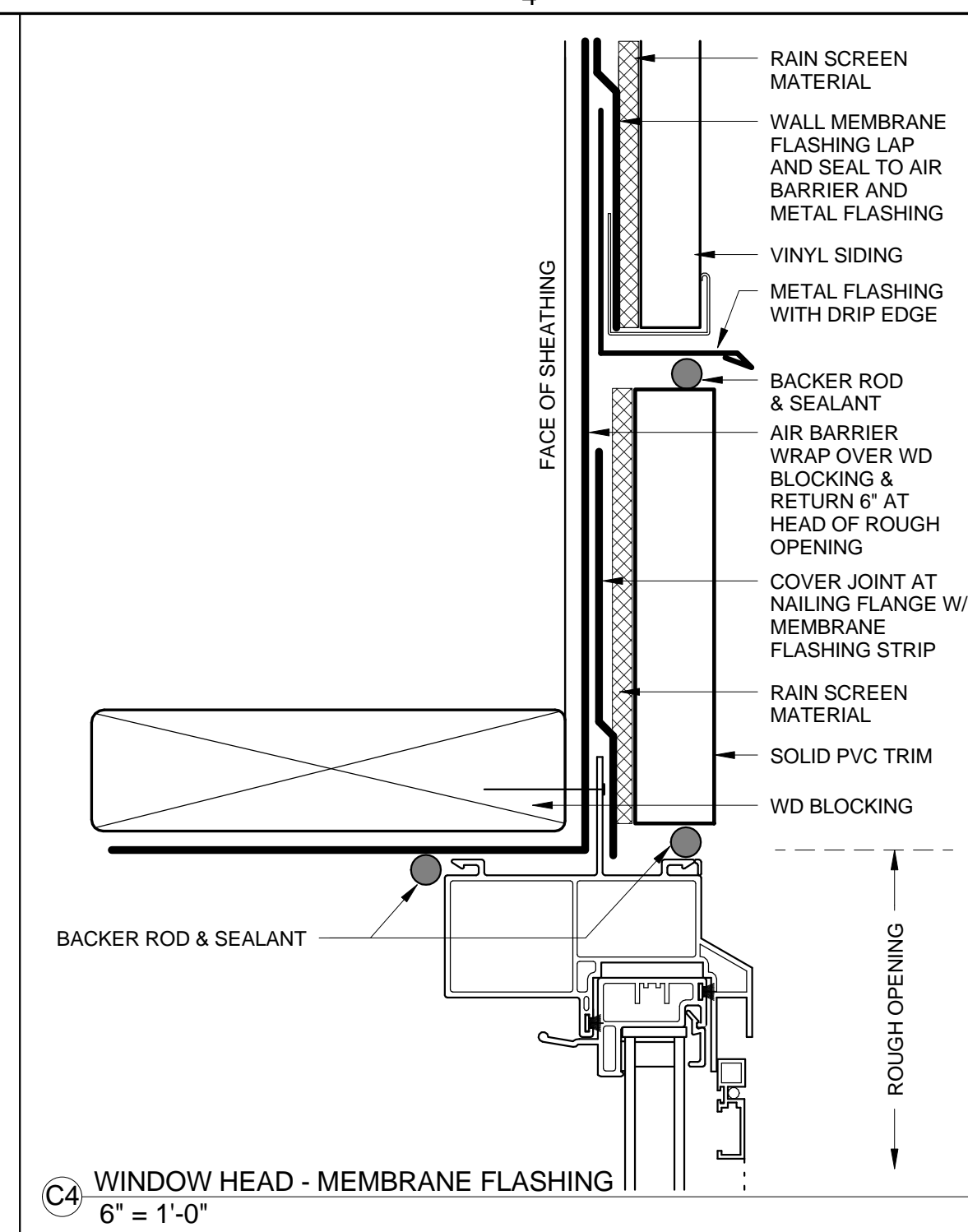

C4 WINDOW HEAD - MEMBRANE FLASHING  
6" = 1'-0"

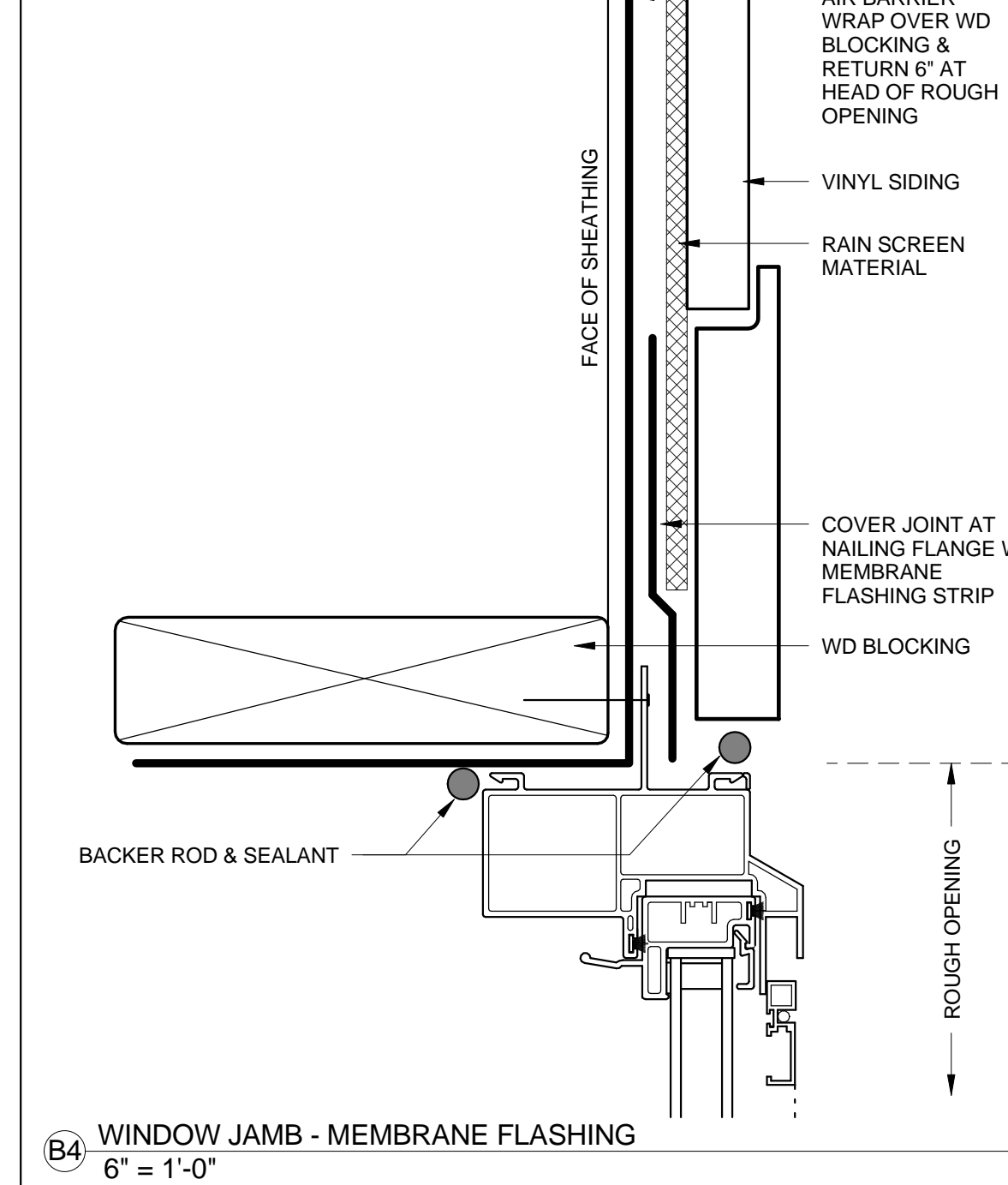

B4 WINDOW JAMB - MEMBRANE FLASHING  
6" = 1'-0"

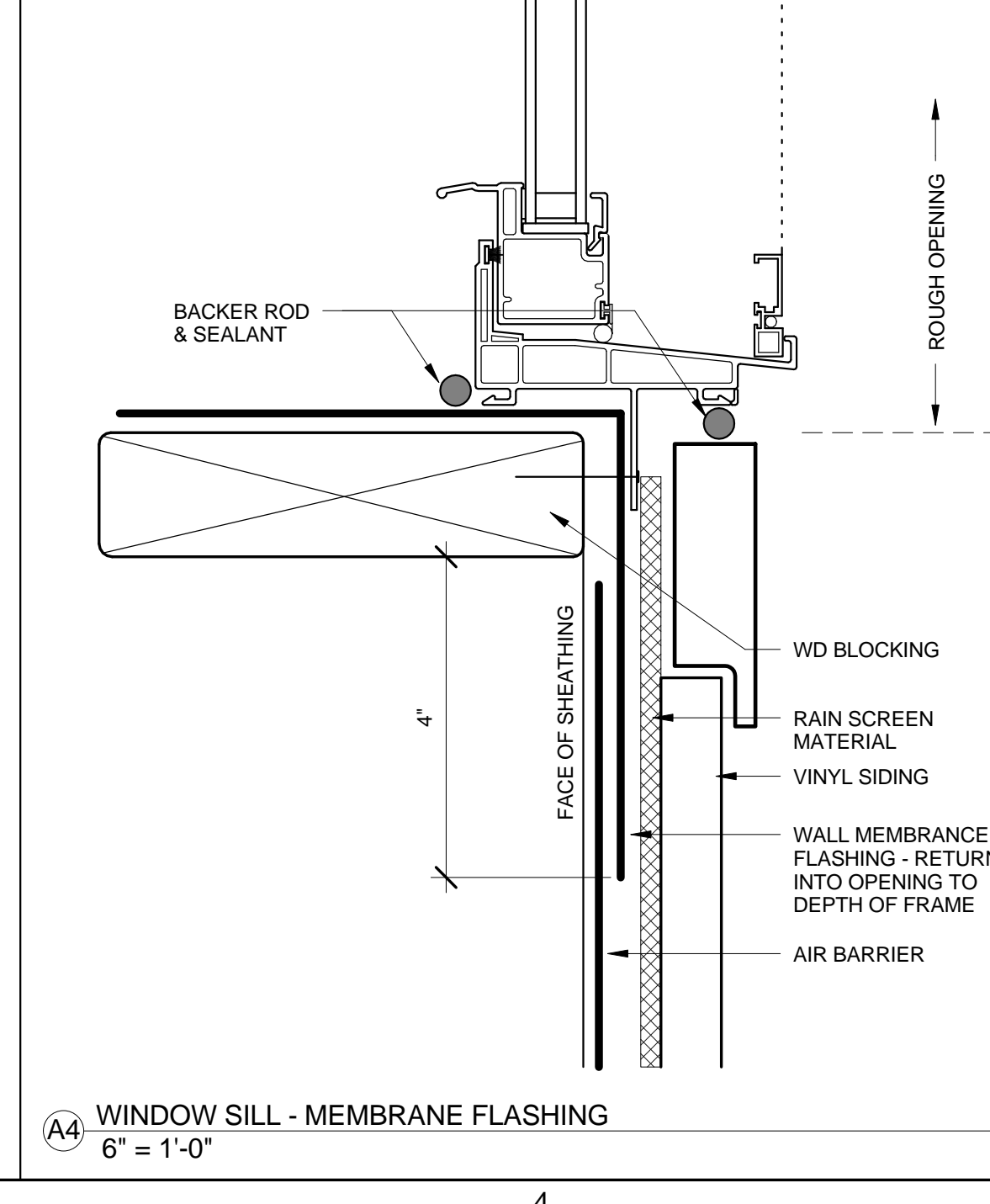

A4 WINDOW SILL - MEMBRANE FLASHING  
6" = 1'-0"

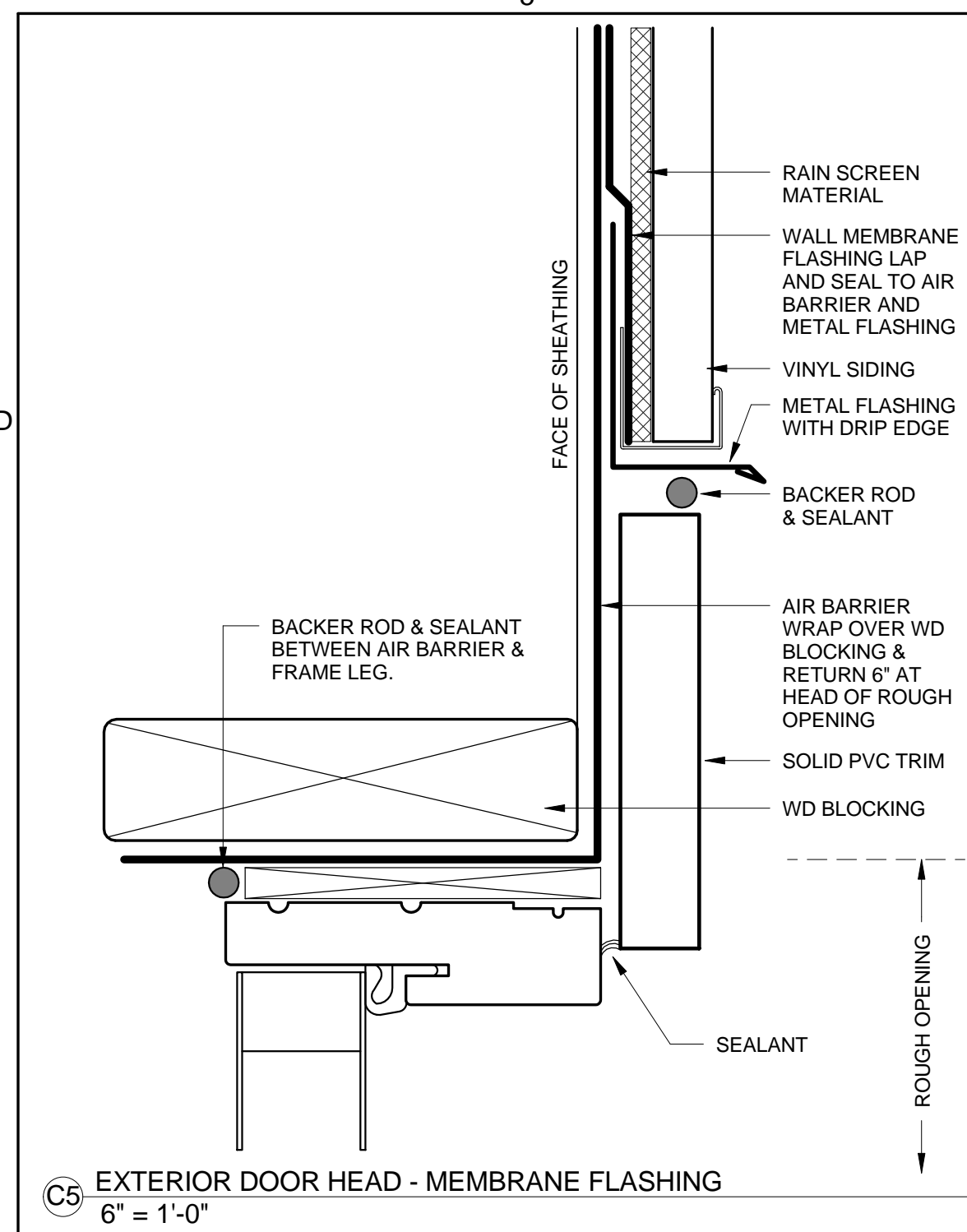

C5 EXTERIOR DOOR HEAD - MEMBRANE FLASHING  
6" = 1'-0"

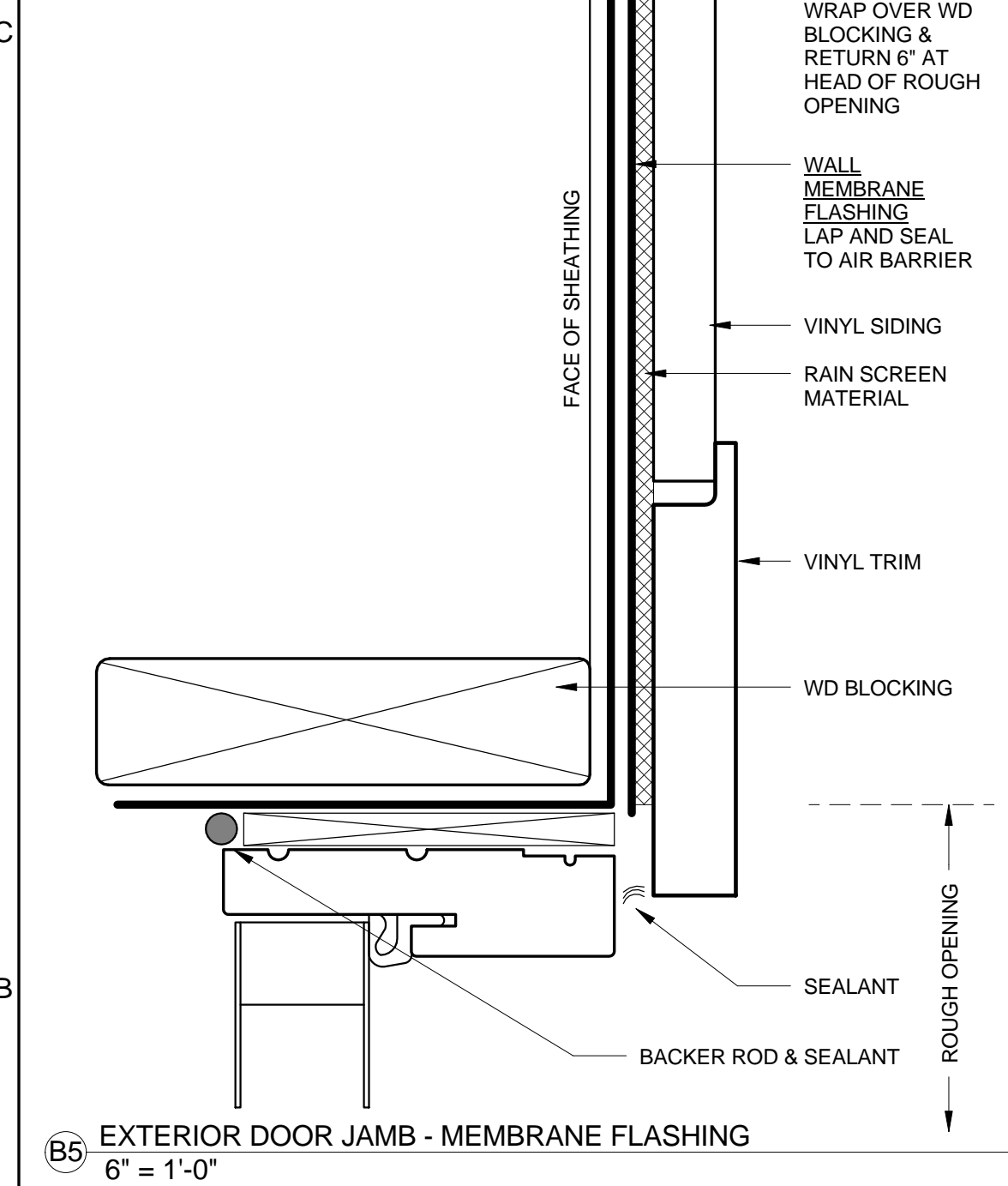

B5 EXTERIOR DOOR JAMB - MEMBRANE FLASHING  
6" = 1'-0"



A5 EXTERIOR DOOR HEAD - MEMBRANE FLASHING  
6" = 1'-0"