

1 JEAN'S BATH - SOUTH
1/2" = 1'-0"

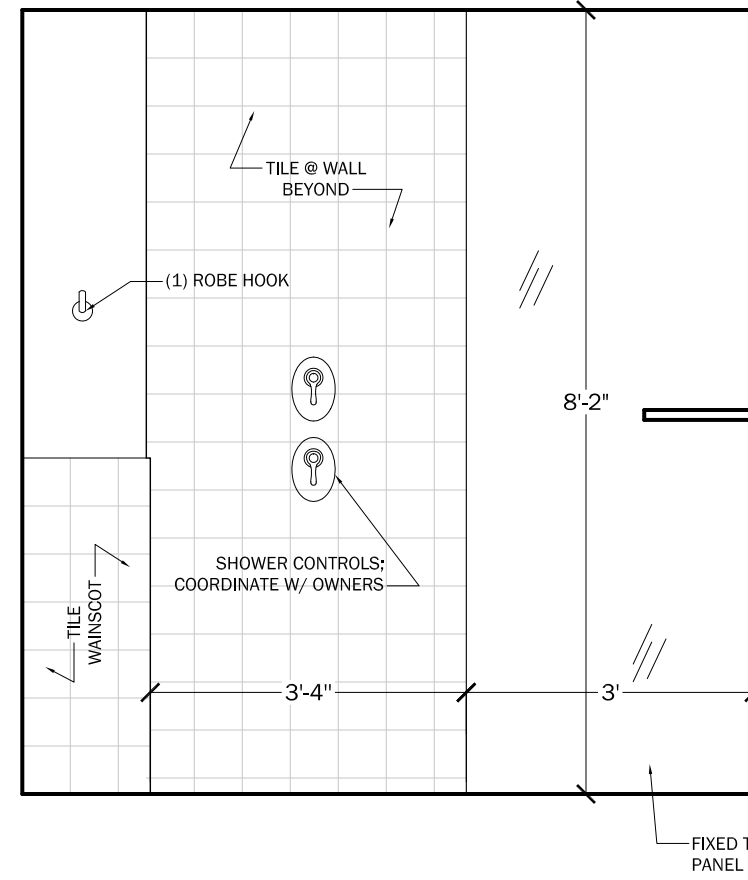

2 JEAN'S BATH - WEST
1/2" = 1'-0"

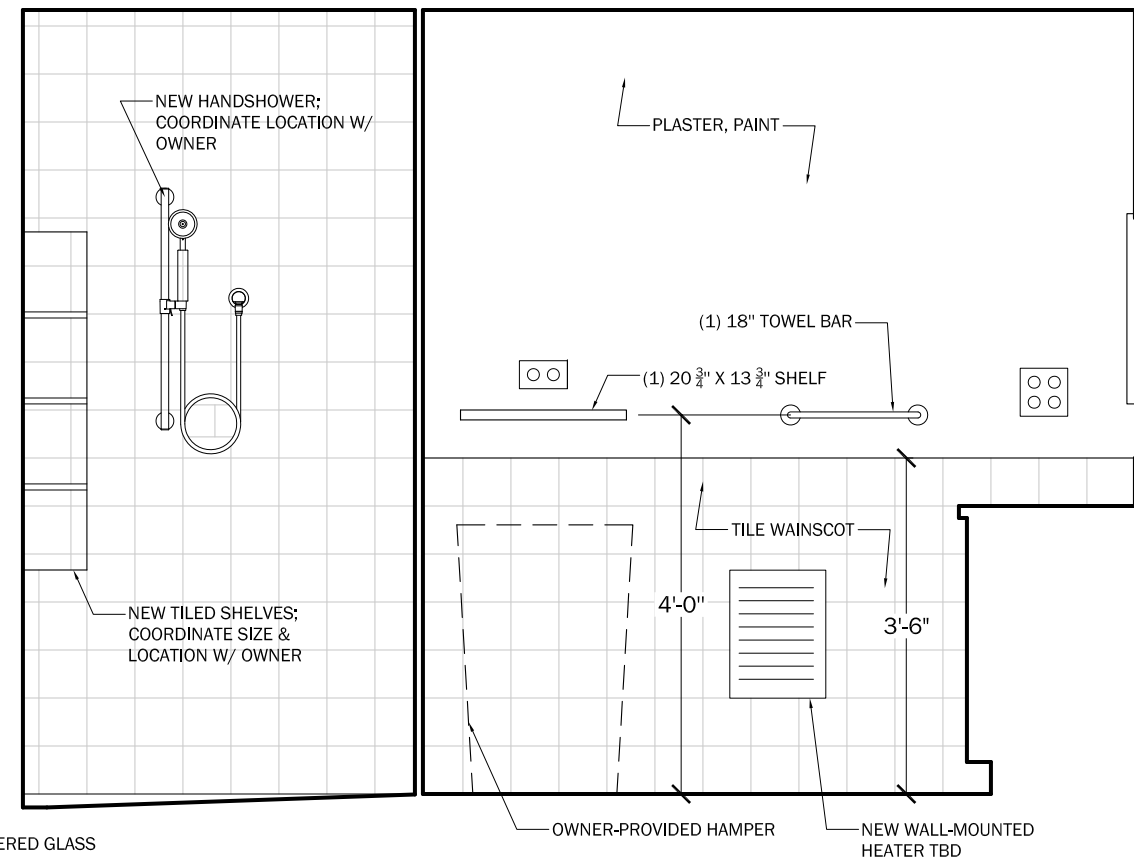

3 JEAN'S BATH - NORTH
1/2" = 1'-0"

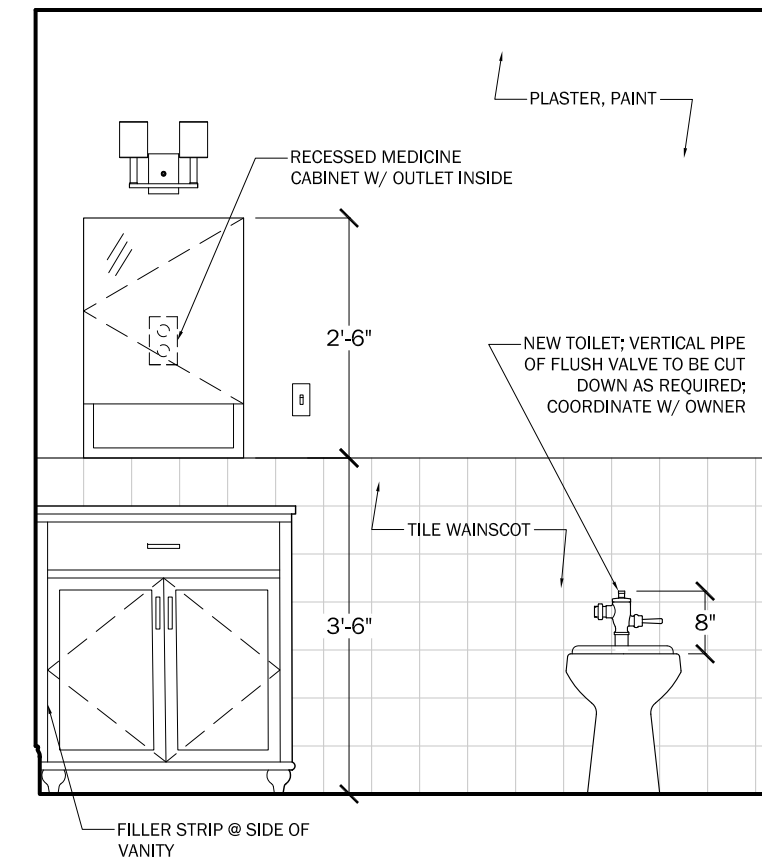

4 JEAN'S BATH - EAST
1/2" = 1'-0"

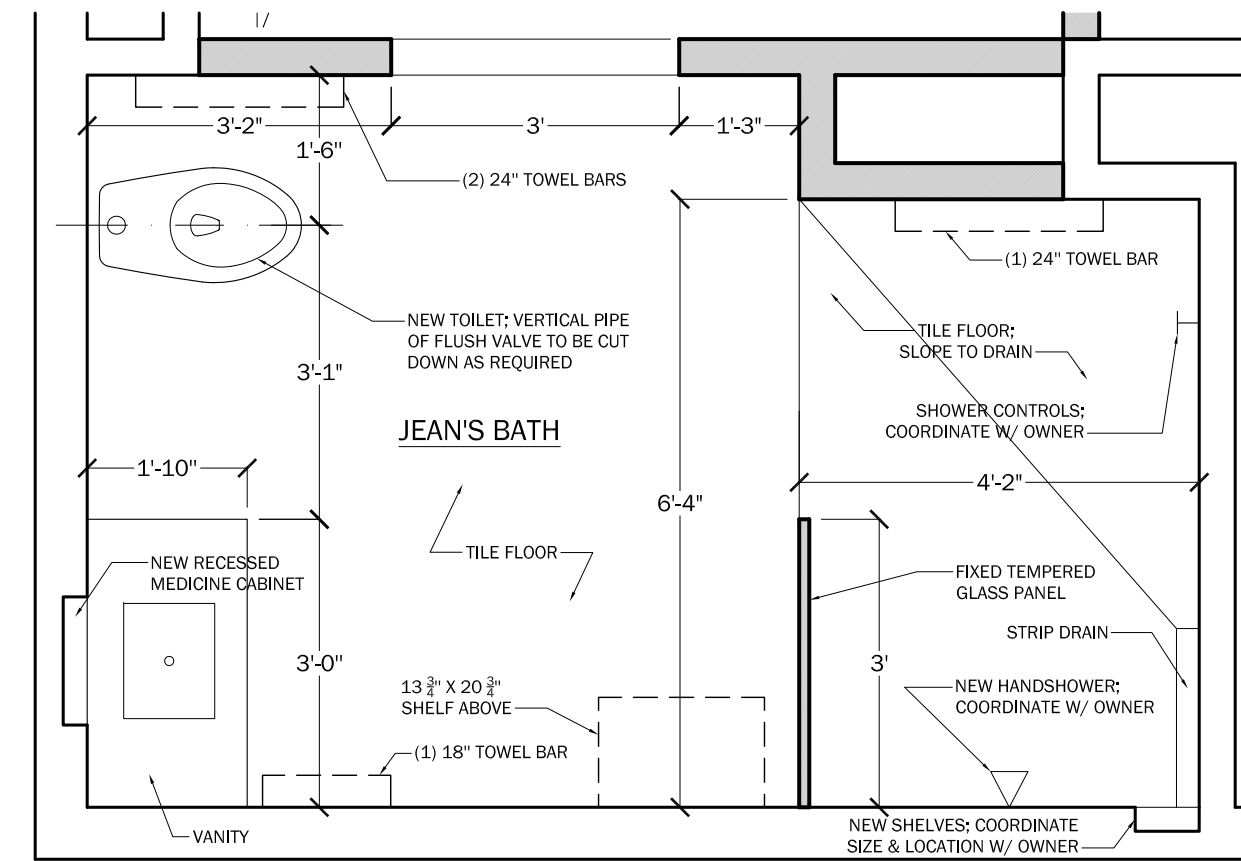

5 ENLARGED PLAN - JEAN'S BATH
1/2" = 1'-0"

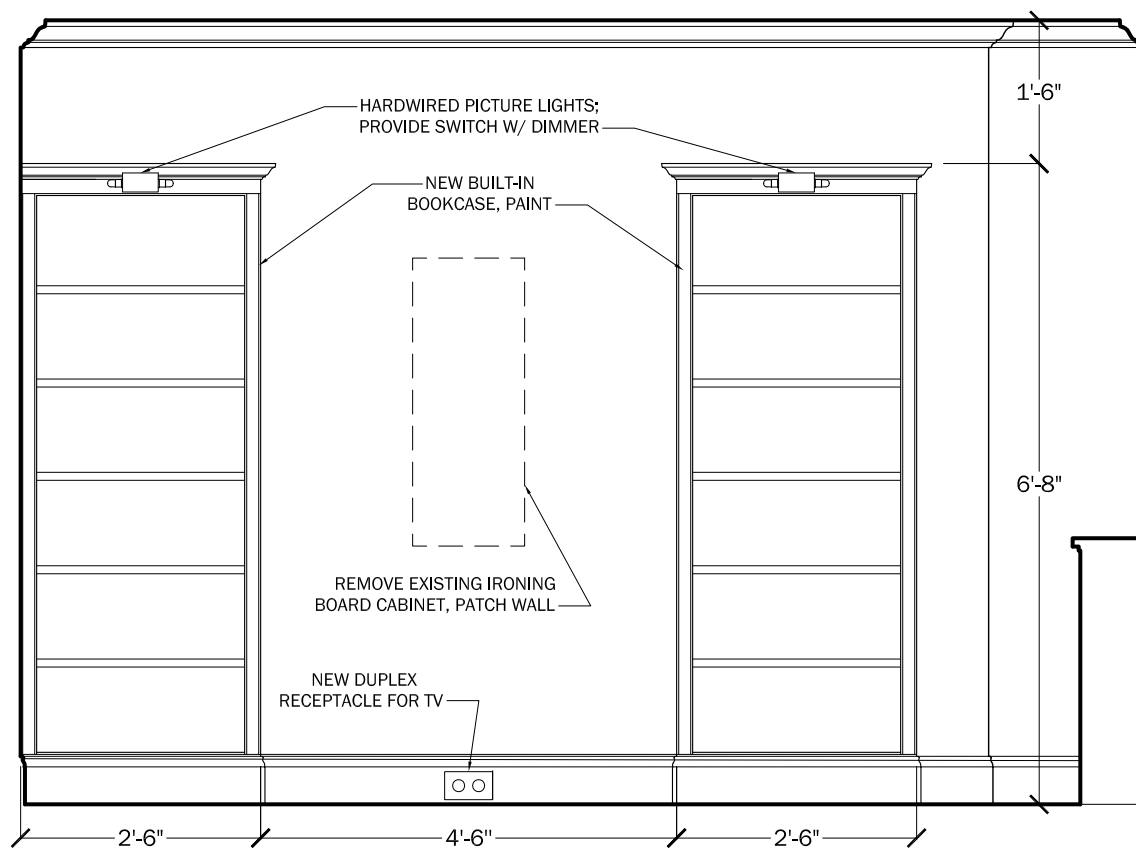

6 TV ROOM - EAST
1/2" = 1'-0"

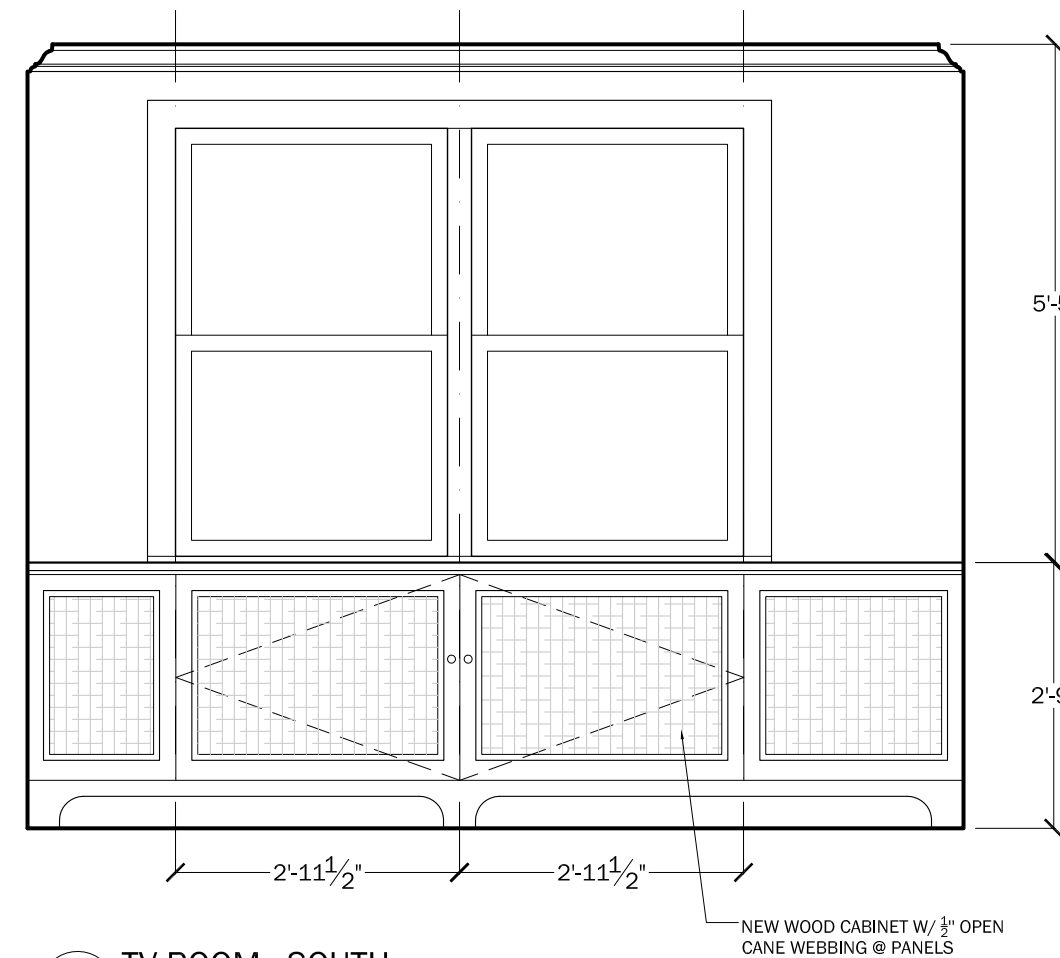

7 TV ROOM - SOUTH
1/2" = 1'-0"

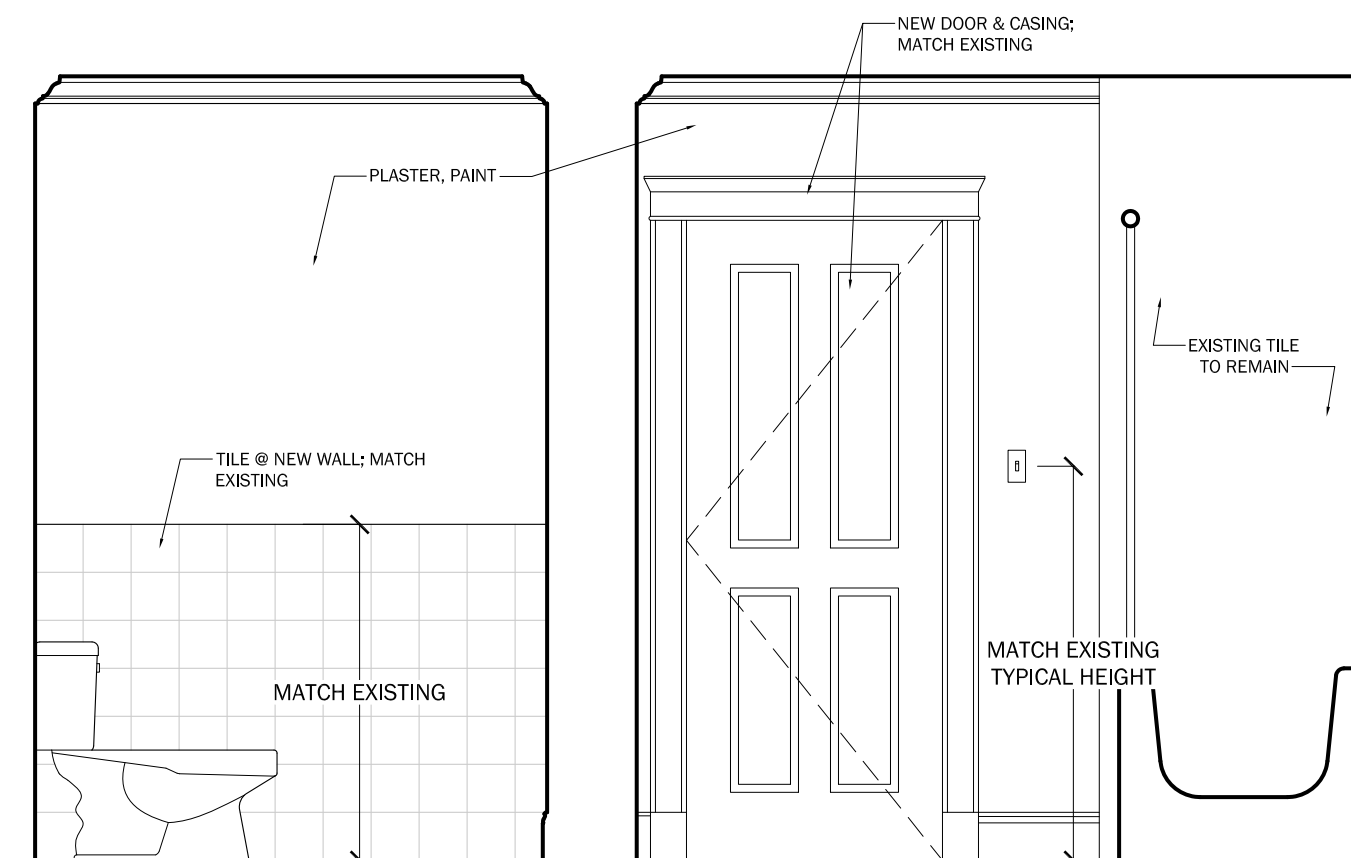

8 GUEST BATH - SOUTH
1/2" = 1'-0"

9 GUEST BATH - WEST
1/2" = 1'-0"

ANGELL RESIDENCE

DESCRIPTION
ESTIMATING DOCUMENTS

DATE
03.27.2017

DRAWING TITLE
INTERIOR ELEVATIONS
& ENLARGED PLANS

KENYON C. BOLTON III & ASSOCIATES
100 GARDEN STREET, CAMBRIDGE, MA
617.547.4440

A-3